

积层陶瓷电容 规格书

产品系列

NM Series

产品名称

常规品

中电压,额定电压 100V ~ 630V

2019.03.31

(Ver.02)

1. 产品简介

汇聚中压设计产品使用无铅/镉元素材料制作。此系列特性产品可应用于较高电压的应用环境。其由精确的介电材料和适当的导电浆料配制，自动化制程的稳定生产和严谨的质量精确管控了介电设计厚度、电极完整性以及端电极连接的良好特性，实现了最佳可靠度的产品性能。

2. 特点

- 2.1. 电压使用选择范围广
- 2.2. 端子电极无铅化
- 2.3. 符合 RoHS 标准
- 2.4. 高可靠性和稳定性

3. 用途

- 3.1. 电源输入/输出滤波
- 3.2. 电源缓冲电路
- 3.3. 功率因素改善
- 3.4. 噪音旁路

4. 型号标示:

NM	1206	B	104	K	251	C	E	G	N
系列	外型尺寸	介电质	电容量	公差	额定电压	端接类型	包装	厚度	管理码
表 1	表 2	表 3	表 4	表 5	表 6	表 7	表 8	表 9	表 10

表 1	系列
代码	说明
NM	常规品-中电压,额定电压 100V~630V

表 2	外型尺寸		
代码	说明: L x W (mm)	代码	说明: L x W (mm)
0603	1.60 x 0.80	1210	3.20 x 2.50
0805	2.00 x 1.25	1812	4.50 x 3.20
1206	3.20 x 1.60	2220	5.70 x 5.00

表 3	介电质		
代码	说明	代码	说明
N	C0G	H	C0H
B	X7R	X	X5R
D	X7E	S	X6R

表 4	电容量		
代码	说明	代码	说明
R47	0.47pF	100	10x10 ⁰ =10pF
0R5	0.5pF	104	10x10 ⁴ =100nF

表 5	公差		
代码	说明	代码	说明
A	±0.05 pF	G	±2 %
B	±0.10 pF	J	±5 %
C	±0.25 pF	K	±10 %
D	±0.50 pF	M	±20 %
F	±1 %	Z	-20% ~ +80%

表 6	额定电压		
代码	说明	代码	说明
6R3	6.3V	101	(10) x 10 ¹ = 100V
100	(10) x 10 ⁰ = 10V	102	(10) x 10 ² = 1000V

表 7	端接类型		
代码	说明	代码	说明
L	Ag+Ni+Sn	C	Cu+Ni+Sn
B	Ag+Soft E+Ni+Sn	E	Cu+Soft E+Ni+Sn

表 8	包装		
代码	说明	代码	说明
P	7" Reel 卷装-纸带	E	7" Reel 卷装-塑料带
R	13" Reel 卷装-纸带	L	13" Reel 卷装-纸带
B	成品散料包装		

表 9	厚度		
代码	说明	代码	说明
A	0.60 ± 0.10 mm	M	2.50 ± 0.30 mm
B	0.8 ± 0.10 mm	O	3.50 ± 0.20 mm
C	0.95 ± 0.10 mm	P	1.60 + 0.30 / -0.10mm
D	1.25 ± 0.10 mm	R	3.10 ± 0.20 mm
G	1.60 ± 0.20 mm	S	0.80 ± 0.07 mm
J	1.15 ± 0.15 mm	U	2.80 ± 0.30 mm
K	2.00 ± 0.20 mm	X	0.80 + 0.50 / -0.10mm

表 10	电容量		
代码	说明	代码	说明
N	无特殊需求		

5.外型尺寸

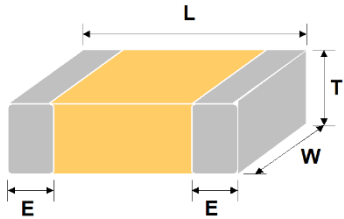
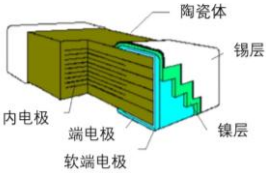
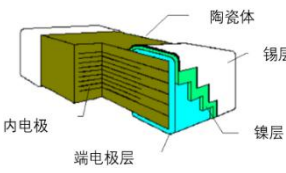
英制尺寸	长度 (L) (mm)	宽度 (W) (mm)	厚度 (T) (mm)	端电极宽 (E) (mm)		
0603	1.60±0.20	0.80±0.15	参阅 4.型号标示 表 9	0.40±0.15	 <p>芯片外观图示</p>	
0805	2.10±0.20	1.25±0.20		0.50±0.20		
1206	3.30±0.30	1.60+0.30/-0.10		0.60±0.20		
1210	3.30±0.40	2.50±0.30		0.75±0.35	 <p>芯片结构图示(软端电极)</p>	
1808	4.60±0.50	2.00±0.20		0.75±0.35		 <p>芯片结构图示(非软端电极)</p>
1812	4.60±0.50	3.20±0.30		0.75±0.35		
1825	4.60±0.50	6.30±0.40		0.75±0.35		
2220	5.70±0.50	5.00±0.40		0.85±0.35		
2225	5.70±0.50	6.30±0.40		0.85±0.35		

6.一般电气规格

介电材料	C0G		X7R	
EIA 尺寸	0603, 0805, 1206, 1210, 1808, 1812, 1825, 2220, 2225		0603, 0805, 1206, 1210, 1808, 1812, 1825, 2220, 2225	
额定电压	100V~630V		100V~630V	
电容范围	0.5pF ~ 180nF		100pF ~ 820nF	
电容公差值	参阅 4.型号标示表 5		参阅 4.型号标示表 5	
损耗角正切 (Tan δ) & 品质因数 (Q)	电容量范围	Q	额定电压	Tan δ (D.F.)
	Cap < 30pF	Q ≥ 400+20C	100V~630V	≤ 2.5%
	Cap ≥ 30pF	Q ≥ 1000		
检测条件	常温 25°C 环境温度		预处理 (2类产品) 150±10°C / 1 小时热处理后静置于常温环境 24±2 小时,再进行测量作业	
	电容量范围	检测条件	适用检测: 1.0±0.2Vrms 1.0kHz±10% 25°C 常温环境	
	Cap ≤ 1000pF	1.0±0.2Vrms 1.0MHz±10%		
Cap > 1000pF	1.0±0.2Vrms 1.0kHz±10%			
绝缘电阻 (IR)	≥ 100GΩ 或 R•C ≥ 500Ω-F 任一较小值以上		≥ 10GΩ 或 R•C ≥ 100Ω-F 任一较小值以上	
工作温度	- 55°C to + 125 °C			
温度系数	±30ppm / °C		±15%	
端电极材料	铜或银/ 镍 / 锡 (无铅端电极)			

7.容值表

7.1. COG 介电质(1)

尺寸		0603			0805					1206				
电容量 (pF)	代码	100V	200V	250V	100V	200V	250V	500V	630V	100V	200V	250V	500V	630V
0.5	0R5	S	S	S	A	A	A	A	A					
0.6	0R6	S	S	S	A	A	A	A	A					
0.7	0R7	S	S	S	A	A	A	A	A					
0.8	0R8	S	S	S	A	A	A	A	A					
0.9	0R9	S	S	S	A	A	A	A	A					
1.0	1R0	S	S	S	A	A	A	A	A					
1.2	1R2	S	S	S	A	A	A	A	A	B				
1.5	1R5	S	S	S	A	A	A	A	A	B	B	B	B	B
1.8	1R8	S	S	S	A	A	A	A	A	B	B	B	B	B
2.2	2R2	S	S	S	A	A	A	A	A	B	B	B	B	B
2.7	2R7	S	S	S	A	A	A	A	A	B	B	B	B	B
3.3	3R3	S	S	S	A	A	A	A	A	B	B	B	B	B
3.9	3R9	S	S	S	A	A	A	A	A	B	B	B	B	B
4.7	4R7	S	S	S	A	A	A	A	A	B	B	B	B	B
5.0	5R0	S	S	S	A	A	A	A	A	B	B	B	B	B
5.6	5R6	S	S	S	A	A	A	A	A	B	B	B	B	B
6.8	6R8	S	S	S	A	A	A	A	A	B	B	B	B	B
8.2	8R2	S	S	S	A	A	A	A	A	B	B	B	B	B
10	100	S	S	S	A	A	A	A	A	B	B	B	B	B
12	120	S	S	S	A	A	A	A	A	B	B	B	B	B
15	150	S	S	S	A	A	A	A	A	B	B	B	B	B
18	180	S	S	S	A	A	A	A	A	B	B	B	B	B
22	220	S	S	S	A	A	A	A	A	B	B	B	B	B
27	270	S	S	S	A	A	A	A	A	B	B	B	B	B
33	330	S	S	S	A	A	A	A	A	B	B	B	B	B
39	390	S	S	S	A	A	A	A	A	B	B	B	B	B
47	470	S	S	S	A	A	A	A	A	B	B	B	B	B
56	560	S	S	S	A	A	A	A	A	B	B	B	B	B
68	680	S	S	S	A	A	A	A	A	B	B	B	B	B
82	820	S	S	S	A	A	A	A	A	B	B	B	B	B
100	101	S	S	S	A	A	A	A	A	B	B	B	B	B
120	121	S	S	S	A	A	A	A	A	B	B	B	B	B
150	151	S	S	S	A	A	A	A	A	B	B	B	B	B
180	181	S	S	S	A	A	A	A	A	B	B	B	B	B
220	221	S	S	S	A	A	A	A	A	B	B	B	B	B
270	271	S	S	S	A	A	A	A	A	B	B	B	B	B
330	331	S	S	S	A	A	A	A	A	B	B	B	B	B
390	391	S	S	S	A	A	A	A	A	B	B	B	B	B
470	471	S	S	S	A	B	B	B	B	B	B	B	B	B
560	561	S	S	S	A	B	B	B	B	B	B	B	B	B
680	681	S	S	S	A	B	B	B	B	B	B	B	B	B
820	821	S	S	S	B	C	C	C	C	B	B	B	B	B
1000	102				B	C	C	C	C	B	B	B	B	B
1200	122				C	D	D	D	D	B	B	B	B	B
1500	152				C	D	D	D	D	B	C	C	C	C
1800	182				C	D	D	D	D	B	C	C	C	C
2200	222				D	D	D	D	D	C	D	D	D	D
2700	272				D					C	D	D	D	D
3300	332				D					D	D	D	D	D
3900	392				D					D	G	G	G	G
4700	472				D					D	G	G	G	G
5600	562									G	G	G	G	G
6800	682									G	G	G		
8200	822									G	G	G		
10000	103									G				
12000	123													
15000	153													
18000	183													
22000	223													
27000	273													
33000	333													
39000	393													
47000	473													
56000	563													
68000	683													
82000	823													
100000	104													
120000	124													
150000	154													
180000	184													

7.容值表

7.1. COG 介电质(2)

尺寸		1210					1808					1812				
电容量 (pF)	代码	100V	200V	250V	500V	630V	100V	200V	250V	500V	630V	100V	200V	250V	500V	630V
0.5	0R5															
0.6	0R6															
0.7	0R7															
0.8	0R8															
0.9	0R9															
1.0	1R0															
1.2	1R2															
1.5	1R5															
1.8	1R8															
2.2	2R2						D	D	D	D	D					
2.7	2R7						D	D	D	D	D					
3.3	3R3						D	D	D	D	D					
3.9	3R9						D	D	D	D	D					
4.7	4R7						D	D	D	D	D					
5.0	5R0						D	D	D	D	D					
5.6	5R6						D	D	D	D	D					
6.8	6R8						D	D	D	D	D					
8.2	8R2						D	D	D	D	D					
10	100	C	C	C	C	C	D	D	D	D	D	D	D	D	D	D
12	120	C	C	C	C	C	D	D	D	D	D	D	D	D	D	D
15	150	C	C	C	C	C	D	D	D	D	D	D	D	D	D	D
18	180	C	C	C	C	C	D	D	D	D	D	D	D	D	D	D
22	220	C	C	C	C	C	D	D	D	D	D	D	D	D	D	D
27	270	C	C	C	C	C	D	D	D	D	D	D	D	D	D	D
33	330	C	C	C	C	C	D	D	D	D	D	D	D	D	D	D
39	390	C	C	C	C	C	D	D	D	D	D	D	D	D	D	D
47	470	C	C	C	C	C	D	D	D	D	D	D	D	D	D	D
56	560	C	C	C	C	C	D	D	D	D	D	D	D	D	D	D
68	680	C	C	C	C	C	D	D	D	D	D	D	D	D	D	D
82	820	C	C	C	C	C	D	D	D	D	D	D	D	D	D	D
100	101	C	C	C	C	C	D	D	D	D	D	D	D	D	D	D
120	121	C	C	C	C	C	D	D	D	D	D	D	D	D	D	D
150	151	C	C	C	C	C	D	D	D	D	D	D	D	D	D	D
180	181	C	C	C	C	C	D	D	D	D	D	D	D	D	D	D
220	221	C	C	C	C	C	D	D	D	D	D	D	D	D	D	D
270	271	C	C	C	C	C	D	D	D	D	D	D	D	D	D	D
330	331	C	C	C	C	C	D	D	D	D	D	D	D	D	D	D
390	391	C	C	C	C	C	D	D	D	D	D	D	D	D	D	D
470	471	C	C	C	C	C	D	D	D	D	D	D	D	D	D	D
560	561	C	C	C	C	C	D	D	D	D	D	D	D	D	D	D
680	681	C	C	C	C	C	D	D	D	D	D	D	D	D	D	D
820	821	C	C	C	C	C	D	D	D	D	D	D	D	D	D	D
1000	102	C	C	C	C	C	D	D	D	D	D	D	D	D	D	D
1200	122	C	C	C	C	C	D	D	D	D	D	D	D	D	D	D
1500	152	C	C	C	C	C	D	D	D	D	D	D	D	D	D	D
1800	182	C	C	C	C	C	D	D	D	D	D	D	D	D	D	D
2200	222	C	C	C	C	C	D	D	D	D	D	D	D	D	D	D
2700	272	C	C	C	C	C	D	D	D	D	D	D	D	D	D	D
3300	332	C	C	C	C	C	D	D	D	D	D	D	D	D	D	D
3900	392	C	D	D	D	D	D	D	D	D	D	D	D	D	D	D
4700	472	C	D	D	D	D	D	D	D	D	D	D	D	D	D	D
5600	562	D	D	D	D	D	D	G	G	G	G	D	D	D	D	D
6800	682	D	G	G	G	G	D	G	G	G	G	D	D	D	D	D
8200	822	D	G	G	G	G	G	K	K	K	K	D	D	D	D	D
10000	103	G	K	K	K	K	G	K	K	K	K	D	D	D	D	D
12000	123	G	K	K	K	K	K	K	K	K	K	D	G	G	G	G
15000	153	K	M	M	M	M	K	K	K			D	G	G	G	G
18000	183	M	M	M			K					G	K	K	K	K
22000	223	M	M	M			K					G	K	K	K	K
27000	273	M										K	M	M	M	M
33000	333	M										K	M	M	M	M
39000	393											M	M	M		
47000	473											M	M			
56000	563											M				
68000	683											M				
82000	823															
100000	104															
120000	124															
150000	154															
180000	184															

7.容值表

7.1. COG 介电质(3)

尺寸		1825					2220					2225				
电容量 (pF)	代码	100V	200V	250V	500V	630V	100V	200V	250V	500V	630V	100V	200V	250V	500V	630V
0.5	0R5															
0.6	0R6															
0.7	0R7															
0.8	0R8															
0.9	0R9															
1.0	1R0															
1.2	1R2															
1.5	1R5															
1.8	1R8															
2.2	2R2															
2.7	2R7															
3.3	3R3															
3.9	3R9															
4.7	4R7															
5.0	5R0															
5.6	5R6															
6.8	6R8															
8.2	8R2															
10	100	G	G	G	G	G	G	G	G	G	G	G	G	G	G	G
12	120	G	G	G	G	G	G	G	G	G	G	G	G	G	G	G
15	150	G	G	G	G	G	G	G	G	G	G	G	G	G	G	G
18	180	G	G	G	G	G	G	G	G	G	G	G	G	G	G	G
22	220	G	G	G	G	G	G	G	G	G	G	G	G	G	G	G
27	270	G	G	G	G	G	G	G	G	G	G	G	G	G	G	G
33	330	G	G	G	G	G	G	G	G	G	G	G	G	G	G	G
39	390	G	G	G	G	G	G	G	G	G	G	G	G	G	G	G
47	470	G	G	G	G	G	G	G	G	G	G	G	G	G	G	G
56	560	G	G	G	G	G	G	G	G	G	G	G	G	G	G	G
68	680	G	G	G	G	G	G	G	G	G	G	G	G	G	G	G
82	820	G	G	G	G	G	G	G	G	G	G	G	G	G	G	G
100	101	G	G	G	G	G	G	G	G	G	G	G	G	G	G	G
120	121	G	G	G	G	G	G	G	G	G	G	G	G	G	G	G
150	151	G	G	G	G	G	G	G	G	G	G	G	G	G	G	G
180	181	G	G	G	G	G	G	G	G	G	G	G	G	G	G	G
220	221	G	G	G	G	G	G	G	G	G	G	G	G	G	G	G
270	271	G	G	G	G	G	G	G	G	G	G	G	G	G	G	G
330	331	G	G	G	G	G	G	G	G	G	G	G	G	G	G	G
390	391	G	G	G	G	G	G	G	G	G	G	G	G	G	G	G
470	471	G	G	G	G	G	G	G	G	G	G	G	G	G	G	G
560	561	G	G	G	G	G	G	G	G	G	G	G	G	G	G	G
680	681	G	G	G	G	G	G	G	G	G	G	G	G	G	G	G
820	821	G	G	G	G	G	G	G	G	G	G	G	G	G	G	G
1000	102	G	G	G	G	G	G	G	G	G	G	G	G	G	G	G
1200	122	G	G	G	G	G	G	G	G	G	G	G	G	G	G	G
1500	152	G	G	G	G	G	G	G	G	G	G	G	G	G	G	G
1800	182	G	G	G	G	G	G	G	G	G	G	G	G	G	G	G
2200	222	G	G	G	G	G	G	G	G	G	G	G	G	G	G	G
2700	272	G	G	G	G	G	G	G	G	G	G	G	G	G	G	G
3300	332	G	G	G	G	G	G	G	G	G	G	G	G	G	G	G
3900	392	G	G	G	G	G	G	G	G	G	G	G	G	G	G	G
4700	472	G	G	G	G	G	G	G	G	G	G	G	G	G	G	G
5600	562	G	G	G	G	G	G	G	G	G	G	G	G	G	G	G
6800	682	G	G	G	G	G	G	G	G	G	G	G	G	G	G	G
8200	822	G	G	G	G	G	G	G	G	G	G	G	G	G	G	G
10000	103	G	G	G	G	G	G	G	G	G	G	G	G	G	G	G
12000	123	G	G	G	G	G	G	G	G	G	G	G	G	G	G	G
15000	153	G	G	G	G	G	G	G	G	G	G	G	G	G	G	G
18000	183	G	G	G	G	G	G	G	G	G	G	G	G	G	G	G
22000	223	G	G	G	G	G	G	G	G	G	G	G	G	G	G	G
27000	273	G	G	G	G	G	G	G	G	G	G	G	G	G	G	G
33000	333	G	G	G	G	G	G	K	K	K	K	G	G	G	G	G
39000	393	G	K	K	K	K	G	K	K	K	K	G	K	K	K	K
47000	473	G	K	K	K	K	G	M	M	M	M	G	K	K	K	K
56000	563	K	M	M	M	M	K	M	M	M	M	G	M	M	M	M
68000	683	K	M	M	M	M	K	M	M	M	M	K	M	M	M	M
82000	823	M	M	M	M	M	M	M	M	M	M	K	M	M	M	M
100000	104	M					M					M	M	M		
120000	124						M					M	M	M		
150000	154											M				
180000	184											M				

7.容值表

7.2. X7R 介电质(1)

尺寸		0603			0805					1206				
电容量 (pF)	代码	100V	200V	250V	100V	200V	250V	500V	630V	100V	200V	250V	500V	630V
100	101	S	X	X	B	B	B	B	B	B	B	B	B	B
120	121	S	X	X	B	B	B	B	B	B	B	B	B	B
150	151	S	X	X	B	B	B	B	B	B	B	B	B	B
180	181	S	X	X	B	B	B	B	B	B	B	B	B	B
220	221	S	X	X	B	B	B	B	B	B	B	B	B	B
270	271	S	X	X	B	B	B	B	B	B	B	B	B	B
330	331	S	X	X	B	B	B	B	B	B	B	B	B	B
390	391	S	X	X	B	B	B	B	B	B	B	B	B	B
470	471	S	X	X	B	B	B	B	B	B	B	B	B	B
560	561	S	X	X	B	B	B	B	B	B	B	B	B	B
680	681	S	X	X	B	B	B	B	B	B	B	B	B	B
820	821	S	X	X	B	B	B	B	B	B	B	B	B	B
1000	102	S	X	X	B	B	B	B	B	B	B	B	B	B
1200	122	S	X	X	B	B	B	B	B	B	B	B	B	B
1500	152	S	X	X	B	B	B	B	B	B	B	B	B	B
1800	182	S	X	X	B	B	B	B	B	B	B	B	B	B
2200	222	S	X	X	B	B	B	B	B	B	B	B	B	B
2700	272	S	X	X	B	B	B	B	B	B	B	B	B	B
3300	332	S	X	X	B	B	B	B	B	B	B	B	B	B
3900	392	S	X	X	B	B	B	B	B	B	B	B	B	B
4700	472	S	X	X	B	B	B	B	B	B	B	B	B	B
5600	562	S	X	X	B	B	B	C	C	B	B	B	B	B
6800	682	S	X	X	B	B	B	D	D	B	B	B	B	B
8200	822	S	X	X	B	B	B	D	D	B	B	B	B	B
10000	103	S	X	X	B	B	B	D	D	B	B	B	C	C
12000	123	X	X	X	B	B	B	D	D	B	B	B	D	D
15000	153	X	X	X	B	B	B	D	D	B	B	B	D	D
18000	183	X			B	B	B	D	D	B	B	B	D	D
22000	223	X			B	B	B	D	D	B	B	B	G	G
27000	273	X			C	C	C			B	B	B	G	G
33000	333	X			C	D	D			B	B	B	G	G
39000	393	X			C	D				B	B	B	G	G
47000	473	X			C	D				B	B	B	G	G
56000	563				C	D				B	C	C		
68000	683				C	D				B	D	D		
82000	823				C					B	D	D		
100000	104				D					B	G	G		
120000	124				D					B				
150000	154				D					B				
180000	184				D					C				
220000	224				D					C				
270000	274									D				
330000	334									G				
390000	394									G				
470000	474									G				
560000	564									P				
680000	684									P				
820000	824									P				

7.容值表

7.2. X7R 介电质(2)

尺寸		1210					1808					1812				
电容量 (pF)	代码	100V	200V	250V	500V	630V	100V	200V	250V	500V	630V	100V	200V	250V	500V	630V
100	101															
120	121															
150	151						D	D	D	D	D					
180	181						D	D	D	D	D					
220	221	C	C	C	C	C	D	D	D	D	D					
270	271	C	C	C	C	C	D	D	D	D	D	D	D	D	D	D
330	331	C	C	C	C	C	D	D	D	D	D	D	D	D	D	D
390	391	C	C	C	C	C	D	D	D	D	D	D	D	D	D	D
470	471	C	C	C	C	C	D	D	D	D	D	D	D	D	D	D
560	561	C	C	C	C	C	D	D	D	D	D	D	D	D	D	D
680	681	C	C	C	C	C	D	D	D	D	D	D	D	D	D	D
820	821	C	C	C	C	C	D	D	D	D	D	D	D	D	D	D
1000	102	C	C	C	C	C	D	D	D	D	D	D	D	D	D	D
1200	122	C	C	C	C	C	D	D	D	D	D	D	D	D	D	D
1500	152	C	C	C	C	C	D	D	D	D	D	D	D	D	D	D
1800	182	C	C	C	C	C	D	D	D	D	D	D	D	D	D	D
2200	222	C	C	C	C	C	D	D	D	D	D	D	D	D	D	D
2700	272	C	C	C	C	C	D	D	D	D	D	D	D	D	D	D
3300	332	C	C	C	C	C	D	D	D	D	D	D	D	D	D	D
3900	392	C	C	C	C	C	D	D	D	D	D	D	D	D	D	D
4700	472	C	C	C	C	C	D	D	D	D	D	D	D	D	D	D
5600	562	C	C	C	C	C	D	D	D	D	D	D	D	D	D	D
6800	682	C	C	C	C	C	D	D	D	D	D	D	D	D	D	D
8200	822	C	C	C	C	C	D	D	D	D	D	D	D	D	D	D
10000	103	C	C	C	C	C	D	D	D	D	D	D	D	D	D	D
12000	123	C	C	C	C	C	G	G	G	G	G	D	D	D	D	D
15000	153	C	C	C	C	C	G	G	G	G	G	D	D	D	D	D
18000	183	C	C	C	D	D	G	G	G	K	K	D	D	D	D	D
22000	223	C	C	C	D	D	G	G	G	K	K	D	D	D	D	D
27000	273	C	C	C	D	D	G	G	G	K	K	D	D	D	D	D
33000	333	C	C	C	G	G	G	G	G	K	K	D	D	D	D	D
39000	393	C	C	C	G	G	G	G	G	K	K	D	D	D	D	D
47000	473	C	C	C	G	G	G	G	G	K	K	D	D	D	D	D
56000	563	C	C	C	G	G	G	G	G	K	K	D	D	D	G	G
68000	683	C	C	C	K	K	G	G	G	K	K	D	D	D	G	G
82000	823	C	C	C	M	M	G	G	G	K	K	D	D	D	G	G
100000	104	C	C	C	M	M	G	G	G	K	K	D	D	D	G	G
120000	124	C	G	G	M	M	G	G	G			D	D	D	K	K
150000	154	C	G	G	M	M	G	G	G			D	D	D	K	K
180000	184	C	G	G			G	K	K			D	D	D	M	M
220000	224	C	G	G			G	K	K			D	D	D	M	M
270000	274	C	K	K			K	K	K			D	G	G	M	
330000	334	C	K	K			K	K	K			D	G	G	M	
390000	394	D	M	M			K	K	K			D	K	K	M	
470000	474	D	M	M			K	K	K			D	K	K	M	
560000	564	G	M	M			K	K	K			D	M	M		
680000	684	G	M	M			K					D	M	M		
820000	824	P					K					D	M	M		

7.容值表

7.2. X7R 介电质(3)

尺寸		1825					2220					2225				
电容量 (pF)	代码	100V	200V	250V	500V	630V	100V	200V	250V	500V	630V	100V	200V	250V	500V	630V
100	101															
120	121															
150	151															
180	181															
220	221															
270	271															
330	331															
390	391															
470	471															
560	561															
680	681															
820	821															
1000	102	K	K	K	K	K	K	K	K	K	K	K	K	K	K	K
1200	122	K	K	K	K	K	K	K	K	K	K	K	K	K	K	K
1500	152	K	K	K	K	K	K	K	K	K	K	K	K	K	K	K
1800	182	K	K	K	K	K	K	K	K	K	K	K	K	K	K	K
2200	222	K	K	K	K	K	K	K	K	K	K	K	K	K	K	K
2700	272	K	K	K	K	K	K	K	K	K	K	K	K	K	K	K
3300	332	K	K	K	K	K	K	K	K	K	K	K	K	K	K	K
3900	392	K	K	K	K	K	K	K	K	K	K	K	K	K	K	K
4700	472	K	K	K	K	K	K	K	K	K	K	K	K	K	K	K
5600	562	K	K	K	K	K	K	K	K	K	K	K	K	K	K	K
6800	682	K	K	K	K	K	K	K	K	K	K	K	K	K	K	K
8200	822	K	K	K	K	K	K	K	K	K	K	K	K	K	K	K
10000	103	K	K	K	K	K	K	K	K	K	K	K	K	K	K	K
12000	123	K	K	K	K	K	K	K	K	K	K	K	K	K	K	K
15000	153	K	K	K	K	K	K	K	K	K	K	K	K	K	K	K
18000	183	K	K	K	K	K	K	K	K	K	K	K	K	K	K	K
22000	223	K	K	K	K	K	K	K	K	K	K	K	K	K	K	K
27000	273	K	K	K	K	K	K	K	K	K	K	K	K	K	K	K
33000	333	K	K	K	K	K	K	K	K	K	K	K	K	K	K	K
39000	393	K	K	K	K	K	K	K	K	K	K	K	K	K	K	K
47000	473	K	K	K	K	K	K	K	K	K	K	K	K	K	K	K
56000	563	K	K	K	K	K	K	K	K	K	K	K	K	K	K	K
68000	683	K	K	K	K	K	K	K	K	K	K	K	K	K	K	K
82000	823	K	K	K	K	K	K	K	K	K	K	K	K	K	K	K
100000	104	K	K	K	K	K	K	K	K	K	K	K	K	K	K	K
120000	124	K	K	K	K	K	K	K	K	K	K	K	K	K	K	K
150000	154	K	K	K	K	K	K	K	K	K	K	K	K	K	K	K
180000	184	K	K	K	K	K	K	K	K	K	K	K	K	K	K	K
220000	224	K	K	K	K	K	K	K	K	K	K	K	K	K	K	K
270000	274	K	K	K	K	K	K	K	K	K	K	K	K	K	K	K
330000	334	K	K	K	K	K	K	K	K	K	K	K	K	K	K	K
390000	394	K	K	K	K	K	K	K	K	K	K	K	K	K	K	K
470000	474	K	K	K	K	K	K	K	K	K	K	K	K	K	K	K
560000	564	K	K	K	M	M	K	K	K	M	M	K	K	K	K	K
680000	684	K	K	K	M	M	K	K	K	M	M	K	K	K	K	K
820000	824	K	K	K	U	U	K	K	K	U	U	K	K	K	M	M

8.可靠度检测条件与质量要求

序号	项目	检测条件	质量要求																		
1.	外观	---	*目视无明显可见缺陷 *外型尺寸符合规格标准																		
2.	电容量	1类产品: Cap≤1000pF, 1.0±0.2Vrms, 1MHz±10% Cap>1000pF, 1.0±0.2Vrms, 1KHz±10% 2类产品: Cap≤10μF, 1.0±0.2Vrms, 1KHz±10%	*不可超出规范定义范围																		
3.	Q值 或 损耗角正切 (Tan δ) (D.F.)	1类产品: Cap≤1000pF, 1.0±0.2Vrms, 1MHz±10% Cap>1000pF, 1.0±0.2Vrms, 1KHz±10% 2类产品: Cap≤10μF, 1.0±0.2Vrms, 1KHz±10%	<table border="1"> <thead> <tr> <th>介电类别</th> <th>额定电压</th> <th>Q/D.F.</th> <th>备注</th> </tr> </thead> <tbody> <tr> <td rowspan="2">Class I</td> <td rowspan="2">All</td> <td>Q≥1000</td> <td>Cap≥30pF</td> </tr> <tr> <td>Q≥400+20C</td> <td>Cap<30pF</td> </tr> <tr> <td rowspan="3">Class II</td> <td rowspan="3">25V</td> <td>D.F. < 3.5%</td> <td></td> </tr> <tr> <td>D.F. < 2.5%</td> <td></td> </tr> <tr> <td>D.F. < 3.0%</td> <td>0603≥0.047μF 0805≥0.18μF 1206≥0.47μF</td> </tr> </tbody> </table>	介电类别	额定电压	Q/D.F.	备注	Class I	All	Q≥1000	Cap≥30pF	Q≥400+20C	Cap<30pF	Class II	25V	D.F. < 3.5%		D.F. < 2.5%		D.F. < 3.0%	0603≥0.047μF 0805≥0.18μF 1206≥0.47μF
介电类别	额定电压	Q/D.F.	备注																		
Class I	All	Q≥1000	Cap≥30pF																		
		Q≥400+20C	Cap<30pF																		
Class II	25V	D.F. < 3.5%																			
		D.F. < 2.5%																			
		D.F. < 3.0%	0603≥0.047μF 0805≥0.18μF 1206≥0.47μF																		
4.	温度特性	<p>无外加电压</p> <table border="1"> <thead> <tr> <th>介电特性</th> <th>操作温度</th> </tr> </thead> <tbody> <tr> <td>X7R</td> <td>-55~125°C at 25°C</td> </tr> <tr> <td>C0G</td> <td>-55~125°C at 25°C</td> </tr> </tbody> </table>	介电特性	操作温度	X7R	-55~125°C at 25°C	C0G	-55~125°C at 25°C	<table border="1"> <thead> <tr> <th>介电特性</th> <th>电容量变异率</th> </tr> </thead> <tbody> <tr> <td>X7R</td> <td>介于±15%之间</td> </tr> <tr> <td>NPO</td> <td>介于±30ppm/°C之间</td> </tr> </tbody> </table>	介电特性	电容量变异率	X7R	介于±15%之间	NPO	介于±30ppm/°C之间						
介电特性	操作温度																				
X7R	-55~125°C at 25°C																				
C0G	-55~125°C at 25°C																				
介电特性	电容量变异率																				
X7R	介于±15%之间																				
NPO	介于±30ppm/°C之间																				
5.	耐电压	<table border="1"> <thead> <tr> <th>额定电压 (V)</th> <th>量测条件</th> </tr> </thead> <tbody> <tr> <td>≤ 250</td> <td>2.0 倍额定电压</td> </tr> <tr> <td>250<V≤500</td> <td>1.5 倍额定电压</td> </tr> <tr> <td>630≤V≤3000</td> <td>1.2 倍额定电压</td> </tr> <tr> <td>3000<V≤5000</td> <td>1.1 倍额定电压</td> </tr> <tr> <td>>5000</td> <td>1.0 倍额定电压</td> </tr> </tbody> </table> <p>*测试电压升压速率 500v/sec *持压时间: 1 to 5 sec *充放电电流 < 50mA</p>	额定电压 (V)	量测条件	≤ 250	2.0 倍额定电压	250<V≤500	1.5 倍额定电压	630≤V≤3000	1.2 倍额定电压	3000<V≤5000	1.1 倍额定电压	>5000	1.0 倍额定电压	*无击穿或是闪火现象						
额定电压 (V)	量测条件																				
≤ 250	2.0 倍额定电压																				
250<V≤500	1.5 倍额定电压																				
630≤V≤3000	1.2 倍额定电压																				
3000<V≤5000	1.1 倍额定电压																				
>5000	1.0 倍额定电压																				
6.	绝缘电阻 (IR)	<table border="1"> <thead> <tr> <th>额定电压 (V)</th> <th>外加电压</th> <th>充电时间</th> </tr> </thead> <tbody> <tr> <td>≤ 100</td> <td>1.0 倍额定电压</td> <td>最长 120 sec</td> </tr> <tr> <td>100 < V ≤ 500</td> <td>1.0 倍额定电压</td> <td>60 sec</td> </tr> <tr> <td>> 500</td> <td>500VDC</td> <td>60 sec</td> </tr> </tbody> </table>	额定电压 (V)	外加电压	充电时间	≤ 100	1.0 倍额定电压	最长 120 sec	100 < V ≤ 500	1.0 倍额定电压	60 sec	> 500	500VDC	60 sec	<table border="1"> <thead> <tr> <th>介电类别</th> <th>要求</th> </tr> </thead> <tbody> <tr> <td>1 类</td> <td>≥100GΩ 或 RxC≥ 500Ω-F 取任一较小值判定</td> </tr> <tr> <td>2 类</td> <td>≥10GΩ 或 RxC≥ 100Ω-F 取任一较小值判定</td> </tr> </tbody> </table>	介电类别	要求	1 类	≥100GΩ 或 RxC≥ 500Ω-F 取任一较小值判定	2 类	≥10GΩ 或 RxC≥ 100Ω-F 取任一较小值判定
额定电压 (V)	外加电压	充电时间																			
≤ 100	1.0 倍额定电压	最长 120 sec																			
100 < V ≤ 500	1.0 倍额定电压	60 sec																			
> 500	500VDC	60 sec																			
介电类别	要求																				
1 类	≥100GΩ 或 RxC≥ 500Ω-F 取任一较小值判定																				
2 类	≥10GΩ 或 RxC≥ 100Ω-F 取任一较小值判定																				
7.	可焊性	<p>* 焊锡温度: 235±5°C 适用 (0603~1210) * 焊锡温度: 245±5°C 适用 (1808~2225) * 浸渍时间: 2±0.5 sec</p>	*端电极上的焊锡层覆盖率不小于 75%																		
8.	耐焊锡热	<p>*预处理 (2类产品): 150±10°C / 1 小时热处理后静置于常温环境 48±4 小时,再进行测量作业 *预热处理: 焊锡浸渍前必须先进行 120~150°C / 1 分钟 预热 *焊锡温度: 260±5°C *浸渍时间: 10±1 sec *后处理: 作业后于常温标准状态下静置一段时间再行检验; (1类) 24±2 小时 (2类) 48±4 小时</p>	<table border="1"> <thead> <tr> <th>介电类别</th> <th>1 类</th> <th>2 类</th> </tr> </thead> <tbody> <tr> <td>端电极外观</td> <td>目视无明显可见缺陷</td> <td>目视无明显可见缺陷</td> </tr> <tr> <td>电容量变化</td> <td>介于±2.5% 或 ±0.25pF 之间 取任一较小值判定</td> <td>介于±7.5%之间</td> </tr> <tr> <td>Q值 或 损耗角正切 (Tan δ) (D.F.)</td> <td>符合初始标准</td> <td>符合初始标准</td> </tr> <tr> <td>绝缘电阻 I.R</td> <td>符合初始标准</td> <td>符合初始标准</td> </tr> <tr> <td>耐电压</td> <td>符合初始标准</td> <td>符合初始标准</td> </tr> </tbody> </table>	介电类别	1 类	2 类	端电极外观	目视无明显可见缺陷	目视无明显可见缺陷	电容量变化	介于±2.5% 或 ±0.25pF 之间 取任一较小值判定	介于±7.5%之间	Q值 或 损耗角正切 (Tan δ) (D.F.)	符合初始标准	符合初始标准	绝缘电阻 I.R	符合初始标准	符合初始标准	耐电压	符合初始标准	符合初始标准
介电类别	1 类	2 类																			
端电极外观	目视无明显可见缺陷	目视无明显可见缺陷																			
电容量变化	介于±2.5% 或 ±0.25pF 之间 取任一较小值判定	介于±7.5%之间																			
Q值 或 损耗角正切 (Tan δ) (D.F.)	符合初始标准	符合初始标准																			
绝缘电阻 I.R	符合初始标准	符合初始标准																			
耐电压	符合初始标准	符合初始标准																			

8.可靠度检测条件与质量要求

序号	项目	测试条件	质量要求																	
9.	温度循环	<p>*预处理 (2类产品): 150±10°C /1 小时热处理后静置于常温环境 48±4 小时,再进行测量作业</p> <p>*参照下表原则执行 5 回次循环测试</p> <table border="1"> <thead> <tr> <th>步骤</th> <th>温度.(°C)</th> <th>时间(分钟)</th> </tr> </thead> <tbody> <tr> <td>1</td> <td>最低工作温度,+0/-3</td> <td>30±3</td> </tr> <tr> <td>2</td> <td>常温</td> <td>2~3</td> </tr> <tr> <td>3</td> <td>最高工作温度,+0/-3</td> <td>30±3</td> </tr> <tr> <td>4</td> <td>常温</td> <td>2~3</td> </tr> </tbody> </table> <p>*后处理: 作业后于常温标准状态下静置一段时间再行检验; (1类) 24±2 小时 (2类) 48±4 小时</p>	步骤	温度.(°C)	时间(分钟)	1	最低工作温度,+0/-3	30±3	2	常温	2~3	3	最高工作温度,+0/-3	30±3	4	常温	2~3	介电类别	1类	2类
			步骤	温度.(°C)	时间(分钟)															
			1	最低工作温度,+0/-3	30±3															
			2	常温	2~3															
			3	最高工作温度,+0/-3	30±3															
			4	常温	2~3															
			端电极外观	目视无明显可见缺陷	目视无明显可见缺陷															
			电容量变化	介于±2.5% 或 ±0.25pF 之间 取任一较小值判定	X7R 介于±7.5%之间															
Q 值 或 损耗角正切 (Tan δ) (D.F.)	≤1.0(Q)×初始值	≤1.5(D.F.)×初始值																		
绝缘电阻 I.R	符合初始标准	符合初始标准																		
耐电压	符合初始标准	符合初始标准																		
10.	耐湿性	<p>*预处理 (2类产品): 150±10°C /1 小时热处理后静置于常温环境 48±4 小时,再进行测量作业</p> <p>*测试温度: 40±2°C</p> <p>*环境湿度: 90~95% RH</p> <p>*测试时间: 500+24/-0hrs</p> <p>*后处理: 作业后于常温标准状态下静置一段时间再行检验; (1类) 24±2 小时 (2类) 48±4 小时</p>	介电类别	1类	2类															
			端电极外观	目视无明显可见缺陷	目视无明显可见缺陷															
			电容量变化	介于±5.0% 或 ±0.5pF 之间 取任一较小值判定	X7R 介于±12.5%之间															
			Q 值 或 损耗角正切 (Tan δ) (D.F.)	<table border="1"> <tr> <td>C ≥ 30pF</td> <td>Q ≥ 350</td> </tr> <tr> <td>10pF ≤ C < 30pF</td> <td>Q ≥ 275 +2.5C</td> </tr> <tr> <td>C < 10pF</td> <td>Q ≥ 200 +10C</td> </tr> </table>	C ≥ 30pF	Q ≥ 350	10pF ≤ C < 30pF	Q ≥ 275 +2.5C	C < 10pF	Q ≥ 200 +10C	D.F. ≤ 200%×初始值									
			C ≥ 30pF	Q ≥ 350																
			10pF ≤ C < 30pF	Q ≥ 275 +2.5C																
			C < 10pF	Q ≥ 200 +10C																
			绝缘电阻 I.R	≥1GΩ 或 R•C ≥ 50Ω-F 取任一较小值判定	≥1GΩ 或 R•C ≥ 50Ω-F 取任一较小值判定															
11.	耐湿负载	<p>*预处理 (2类产品): 150±10°C /1 小时热处理后静置于常温环境 48±4 小时,再进行测量作业</p> <p>*测试温度: 40±2°C</p> <p>*环境湿度: 90~95% RH</p> <p>*测试时间: 500+24/-0hrs</p> <p>*外加电压: 额定电压</p> <p>*后处理: 作业后于常温标准状态下静置一段时间再行检验; (1类) 24±2 小时 (2类) 48±4 小时</p>	介电类别	1类	2类															
			端电极外观	目视无明显可见缺陷	目视无明显可见缺陷															
			电容量变化	介于±7.5% 或 ±0.75pF 之间 取任一较小值判定	X7R 介于±12.5%之间															
			Q 值 或 损耗角正切 (Tan δ) (D.F.)	<table border="1"> <tr> <td>C ≥ 30pF</td> <td>Q ≥ 350</td> </tr> <tr> <td>10pF ≤ C < 30pF</td> <td>Q ≥ 275 +2.5C</td> </tr> <tr> <td>C < 10pF</td> <td>Q ≥ 200 +10C</td> </tr> </table>	C ≥ 30pF	Q ≥ 350	10pF ≤ C < 30pF	Q ≥ 275 +2.5C	C < 10pF	Q ≥ 200 +10C	D.F. ≤ 200%×初始值									
			C ≥ 30pF	Q ≥ 350																
			10pF ≤ C < 30pF	Q ≥ 275 +2.5C																
			C < 10pF	Q ≥ 200 +10C																
			绝缘电阻 I.R	≥1GΩ 或 R•C ≥ 50Ω-F 取任一较小值判定	≥1GΩ 或 R•C ≥ 50Ω-F 取任一较小值判定															

8.可靠度检测条件与质量要求

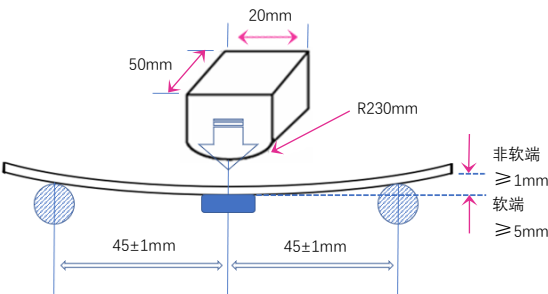
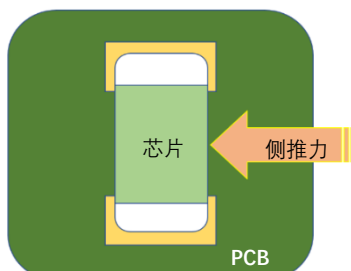
序号	项目	测试条件	质量要求																																																		
12.	高温负荷	*需将芯片通过 reflow 焊接于 PCB 板上 *测试温度: 125±3°C <table border="1"> <tr> <th>R 额定电压(V)</th> <th>外加电压</th> </tr> <tr> <td>≤ 250</td> <td>2.0 倍额定电压</td> </tr> <tr> <td>250 < V ≤ 500</td> <td>1.5 倍额定电压</td> </tr> <tr> <td>630 ≤ V ≤ 1000</td> <td>1.2 倍额定电压</td> </tr> <tr> <td>1000 < V ≤ 5000V</td> <td>1.1 倍额定电压</td> </tr> <tr> <td>> 5000</td> <td>1.0 倍额定电压</td> </tr> </table> 特例规格(仅限 X7R): <table border="1"> <tr> <th>额定电压(V)</th> <th>外型尺寸</th> <th>电容量范围</th> <th>外加电压</th> </tr> <tr> <td rowspan="5">100</td> <td>0805</td> <td>≥ 124</td> <td rowspan="10">1.5 倍 额定电压</td> </tr> <tr> <td>1206</td> <td rowspan="4">≥ 105</td> </tr> <tr> <td>1210</td> </tr> <tr> <td>1825</td> </tr> <tr> <td>2220</td> </tr> <tr> <td>2225</td> <td>> 224</td> </tr> <tr> <td rowspan="5">200 & 250</td> <td>1812</td> <td>> 474</td> </tr> <tr> <td>1825</td> <td rowspan="4">≥ 105</td> </tr> <tr> <td>2220</td> </tr> <tr> <td>2225</td> </tr> <tr> <td>2225</td> </tr> </table> *测试时程: 1000+24/-0 hrs *后处理: 作业后于常温标准状态下静置一段时间再行检验: (1类) 24±2 小时 (2类) 48±4 小时	R 额定电压(V)	外加电压	≤ 250	2.0 倍额定电压	250 < V ≤ 500	1.5 倍额定电压	630 ≤ V ≤ 1000	1.2 倍额定电压	1000 < V ≤ 5000V	1.1 倍额定电压	> 5000	1.0 倍额定电压	额定电压(V)	外型尺寸	电容量范围	外加电压	100	0805	≥ 124	1.5 倍 额定电压	1206	≥ 105	1210	1825	2220	2225	> 224	200 & 250	1812	> 474	1825	≥ 105	2220	2225	2225	<table border="1"> <tr> <th>介电类别</th> <th>1 类</th> <th>2 类</th> </tr> <tr> <td>端电极外观</td> <td>目视无明显可见缺陷</td> <td>目视无明显可见缺陷</td> </tr> <tr> <td>电容量变化</td> <td>介于±3.0% 或 ±2.0pF 之间 取任一较大值判定</td> <td>X7R 介于±12.5%之间</td> </tr> <tr> <td>Q 值 或 损耗角正切 (Tan δ) (D.F.)</td> <td>D.F. ≤ 200% × 初始值</td> <td>D.F. ≤ 200% × 初始值</td> </tr> <tr> <td>绝缘电阻 I.R</td> <td>≥ 1GΩ 或 R•C ≥ 50Ω-F 取任一较小值判定</td> <td>≥ 1GΩ 或 R•C ≥ 50Ω-F 取任一较小值判定</td> </tr> </table>	介电类别	1 类	2 类	端电极外观	目视无明显可见缺陷	目视无明显可见缺陷	电容量变化	介于±3.0% 或 ±2.0pF 之间 取任一较大值判定	X7R 介于±12.5%之间	Q 值 或 损耗角正切 (Tan δ) (D.F.)	D.F. ≤ 200% × 初始值	D.F. ≤ 200% × 初始值	绝缘电阻 I.R	≥ 1GΩ 或 R•C ≥ 50Ω-F 取任一较小值判定	≥ 1GΩ 或 R•C ≥ 50Ω-F 取任一较小值判定
		R 额定电压(V)	外加电压																																																		
≤ 250	2.0 倍额定电压																																																				
250 < V ≤ 500	1.5 倍额定电压																																																				
630 ≤ V ≤ 1000	1.2 倍额定电压																																																				
1000 < V ≤ 5000V	1.1 倍额定电压																																																				
> 5000	1.0 倍额定电压																																																				
额定电压(V)	外型尺寸	电容量范围	外加电压																																																		
100	0805	≥ 124	1.5 倍 额定电压																																																		
	1206	≥ 105																																																			
	1210																																																				
	1825																																																				
	2220																																																				
2225	> 224																																																				
200 & 250	1812	> 474																																																			
	1825	≥ 105																																																			
	2220																																																				
	2225																																																				
	2225																																																				
介电类别	1 类	2 类																																																			
端电极外观	目视无明显可见缺陷	目视无明显可见缺陷																																																			
电容量变化	介于±3.0% 或 ±2.0pF 之间 取任一较大值判定	X7R 介于±12.5%之间																																																			
Q 值 或 损耗角正切 (Tan δ) (D.F.)	D.F. ≤ 200% × 初始值	D.F. ≤ 200% × 初始值																																																			
绝缘电阻 I.R	≥ 1GΩ 或 R•C ≥ 50Ω-F 取任一较小值判定	≥ 1GΩ 或 R•C ≥ 50Ω-F 取任一较小值判定																																																			
13.	挠曲试验	*焊接在印刷电路板上的芯片元件必须能承受至少基板弯曲: 非软端品 ≥ 1mm 程度 / 软端品 ≥ 5mm 程度 *使用圆径 230mm/宽度 20mm/长度 50mm 的压杆进行测试时必须推压印刷电路板的中心点位置 (同芯片元件中心点), 推压速度为 1mm/秒, 持续推压直到需求弯曲程度或是失效为止 	<table border="1"> <tr> <th>介电类别</th> <th>1 类</th> <th>2 类</th> </tr> <tr> <td>端电极外观</td> <td>目视无明显可见缺陷</td> <td>目视无明显可见缺陷</td> </tr> <tr> <td>电容量变化</td> <td>介于±3.0% 或 ±2.0pF 之间 取任一较大值判定</td> <td>X7R 介于±12.5%之间</td> </tr> </table> (电容量的差异变化量参考点为板弯零点 (未弯曲) 数值.)	介电类别	1 类	2 类	端电极外观	目视无明显可见缺陷	目视无明显可见缺陷	电容量变化	介于±3.0% 或 ±2.0pF 之间 取任一较大值判定	X7R 介于±12.5%之间																																									
		介电类别	1 类	2 类																																																	
端电极外观	目视无明显可见缺陷	目视无明显可见缺陷																																																			
电容量变化	介于±3.0% 或 ±2.0pF 之间 取任一较大值判定	X7R 介于±12.5%之间																																																			
14.	端极强度	*将芯片焊接在基板上. 从侧面方向在芯片两端电极间的中心位置施加一个 5N(≤ 0603) 或 10N(> 0603) 的垂直力, 并维持加压侧推 10±1 秒的时间 	*芯片元件无产生目视可见缺损缺陷, 或由印刷线路上脱落.																																																		
		15.	振动试验	* 振动频率 : 10~55 Hz/每分 * 振幅(amplitude) : 1.5mm * 检验时间 : 6 小时(X/Y/Z 每三方向 各 2 小时)	*芯片元件无产生目视可见缺损缺陷, 或由印刷线路上脱落. *电容变异 & Q/DF : 符合初始规格																																																

9. 包装尺寸规格及数量

尺寸	厚度 (mm)	纸带		塑带	
		7" 卷轮	13" 卷轮	7" 卷轮	13" 卷轮
0603	0.80±0.07	4K	15K	-	-
	0.80+0.15/-0.10	4K	15K		
0805	0.60±0.10	4K	15K	-	-
	0.80±0.10	4K	15K	-	-
	1.25±0.10	-	-	3K	10K
	1.25±0.20	-	-	3K	-
1206	0.80±0.10	4K	15K	-	-
	0.95±0.10	-	-	3K	10K
	1.25±0.10	-	-	3K	10K
	1.60±0.20	-	-	2K	-
1210	0.95±0.10	-	-	3K	10K
	1.25±0.10	-	-	3K	10K
	1.60±0.20	-	-	2K	-
	2.50±0.30	-	-	1K	-
1808	1.25±0.10	-	-	2K	-
	1.60±0.20	-	-	2K	-
	2.00±0.20	-	-	1K	-
1812	1.25±0.10	-	-	1K	-
	1.60±0.20	-	-	1K	-
	2.00±0.20	-	-	1K	-
	2.50±0.30	-	-	0.5K	-
1825	1.60±0.20	-	-	1K	-
	2.00±0.20	-	-	1K	-
	2.50±0.30	-	-	0.5K	-
	2.80±0.30	-	-	0.5K	-
2211	2.00±0.20	-	-	1K	-
	2.50±0.30	-	-	0.5K	-
2220	1.60±0.20	-	-	1K	-
	2.00±0.20	-	-	1K	-
	2.50±0.30	-	-	0.5K	-
	2.80±0.30	-	-	0.5K	-
2225	1.60±0.20	-	-	1K	-
	2.00±0.20	-	-	1K	-
	2.50±0.30	-	-	0.5K	-
	2.80±0.30	-	-	0.5K	-

包装数量单位: pcs

9. 包装尺寸规格及数量

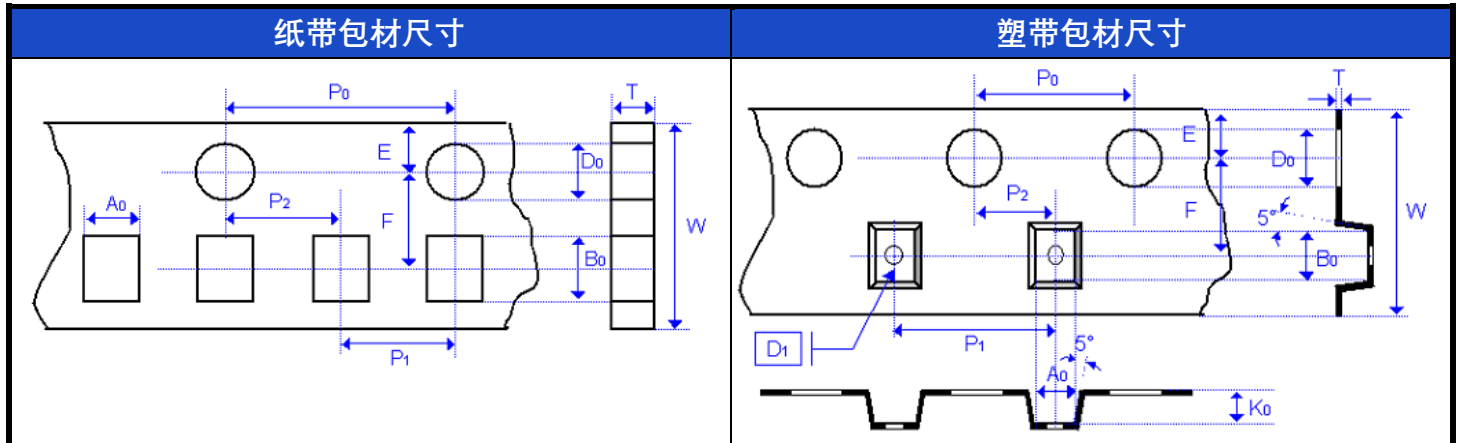

外型尺寸	0603		0805		1206		
芯片厚度	0.80±0.07	0.80+0.15/-0.10	0.80±0.10	1.25±0.10 1.25±0.20	0.80±0.10	0.95±0.10 1.25±0.10	1.60±0.20 1.60+0.3/-0.1
A ₀	1.00+0.05/-0.10	1.02+0.05/-0.10	1.50±0.10	<1.65	2.00±0.10	<2.00	<2.00
B ₀	1.80±0.10	1.80±0.10	2.30±0.10	<2.40	3.50±0.10	<3.60	<3.70
T	0.95±0.05	0.97±0.05	0.95±0.05	0.23±0.05	0.95±0.05	0.23±0.05	0.23±0.05
K ₀	-	-	-	<2.50	-	<2.50	<2.50
W	8.00±0.10	8.00±0.10	8.00±0.10	8.00±0.10	8.00±0.10	8.00±0.10	8.00±0.10
P ₀	4.00±0.10	4.00±0.10	4.00±0.10	4.00±0.10	4.00±0.10	4.00±0.10	4.00±0.10
10×P ₀	40.00±0.20	40.00±0.20	40.00±0.20	40.00±0.20	40.00±0.20	40.00±0.20	40.00±0.20
P ₁	4.00±0.10	4.00±0.10	4.00±0.10	4.00±0.10	4.00±0.10	4.00±0.10	4.00±0.10
P ₂	2.00±0.05	2.00±0.05	2.00±0.05	2.00±0.05	2.00±0.05	2.00±0.05	2.00±0.05
D ₀	1.55±0.05	1.55±0.05	1.55±0.05	1.50±0.10/-0	1.55±0.05	1.50±0.10/-0	1.50±0.10/-0
D ₁	-	-	-	1.00±0.10	-	1.00±0.10	1.00±0.10
E	1.75±0.05	1.75±0.05	1.75±0.05	1.75±0.10	1.75±0.10	1.75±0.10	1.75±0.10
F	3.50±0.05	3.50±0.05	3.50±0.05	3.50±0.05	3.50±0.05	3.50±0.05	3.50±0.05
尺寸单位	mm	mm	mm	mm	mm	mm	mm

外型尺寸	1210		1808		1812	
芯片厚度	0.95±0.10 1.25±0.10 1.60±0.20	2.50±0.30	1.25±0.10 1.60±0.20	2.00±0.20	1.25±0.10 1.60±0.20 2.00±0.20	2.50±0.30
A ₀	<3.05	<3.10	<2.50	<2.50	<3.90	<3.90
B ₀	<3.80	<4.00	<5.30	<5.30	<5.30	<5.30
T	0.23±0.05	0.23±0.05	0.25±0.05	0.25±0.05	0.25±0.05	0.25±0.05
K ₀	<2.50	<3.50	<2.50	<2.50	<2.50	<3.00
W	8.00±0.10	8.00±0.10	12.0±0.20	12.0±0.20	12.0±0.20	12.0±0.20
P ₀	4.00±0.100	4.00±0.10	4.00±0.10	4.00±0.10	4.00±0.10	4.00±0.10
10×P ₀	40.00±0.20	40.0±0.10	40.0±0.20	40.0±0.20	40.00±0.20	40.00±0.20
P ₁	4.00±0.10	4.00±0.10	4.00±0.10	4.00±0.10	8.00±0.10	8.00±0.10
P ₂	2.00±0.05	2.00±0.05	2.00±0.05	2.00±0.05	2.00±0.05	2.00±0.05
D ₀	1.50±0.10/-0	1.50±0.10/-0	1.50±0.10/-0	1.50±0.10/-0	1.50±0.10/-0	1.50±0.10/-0
D ₁	1.00±0.10	1.00±0.10	1.50±0.10	1.50±0.10	1.50±0.10	1.50+/-0.10
E	1.75±0.10	1.75±0.10	1.75±0.10	1.75±0.10	1.75±0.10	1.75+/-0.1
F	3.50±0.05	3.50±0.05	5.50±0.05	5.50±0.05	5.50±0.05	5.50+/-0.05
尺寸单位	mm	mm	mm	mm	mm	mm

9. 包装尺寸规格及数量

外型尺寸	1825		2211		2220		2225	
芯片厚度	1.60±0.20 1.60±0.20 2.00±0.20	2.50±0.30	2.00±0.20	2.50±0.20	2.00±0.20 1.60±0.20	2.50±0.30	1.60±0.20 2.00±0.20	2.50±0.30
A ₀	<6.80	<6.80	< 3.30	< 3.30	<5.80	<5.80	<6.80	<6.80
B ₀	<5.30	<5.30	< 6.50	< 6.50	<6.50	<6.50	<6.50	<6.50
T	0.30±0.10	0.30±0.10	0.30±0.10	0.30±0.10	0.30±0.10	0.30±0.10	0.30±0.10	0.30±0.10
K ₀	<2.50	<3.10	<2.50	< 3.10	<2.50	<3.10	<2.50	<3.10
W	12.0±0.20	12.0±0.20	12.0±0.20	12.0±0.20	12.0±0.20	12.0±0.20	12.0±0.20	12.0±0.20
P ₀	4.00±0.10	4.00±0.10	4.00±0.10	4.00±0.10	4.00±0.10	4.00±0.10	4.00±0.10	4.00±0.10
10xP ₀	40.00±0.20	40.00±0.20	40.00±0.20	40.00±0.20	40.00±0.20	40.00±0.20	40.00±0.20	40.00±0.20
P ₁	8.00±0.10	8.00±0.10	8.00±0.10	8.00±0.10	8.00±0.10	8.00±0.10	8.00±0.10	8.00±0.10
P ₂	2.00±0.05	2.00±0.05	2.00±0.05	2.00±0.05	2.00±0.05	2.00±0.05	2.00±0.05	2.00±0.05
D ₀	1.50+0.10/-0	1.50+0.10/-0	1.50+0.10/-0	1.50+0.10/-0	1.50+0.10/-0	1.50+0.10/-0	1.50+0.10/-0	1.50+0.10/-0
D ₁	1.50±0.10	1.50±0.10	1.50±0.10	1.50±0.10	1.50±0.10	1.50±0.10	1.50±0.10	1.50±0.10
E	1.75±0.1	1.75±0.10	1.75±0.1	1.75±0.1	1.75±0.1	1.75±0.10	1.75±0.10	1.75±0.10
F	5.50±0.05	5.50±0.05	5.50±0.05	5.50±0.05	5.50±0.05	5.50±0.05	5.50±0.05	5.50±0.05
尺寸单位	mm	mm	mm	mm	mm	mm	mm	mm

卷轮尺寸

外型尺寸	0603, 0805, 1206, 1210			1808,1812, 1825, 2211,2220,2225
卷轮尺寸	7"	7"	13"	7"
C	13.0 +0.5/-0.2	13.0 +0.5/-0.2	13.0 +0.5/-0.2	13.0 +0.5/-0.2
W ₁	8.4 +1.5/-0	8.4 +1.5/-0	8.4 +1.5/-0	12.4 +2.0/-0
A	178.0 ±0.10	178.0 ±0.10	330.0 ±1.0	178.0 ±0.10
N	60.0 +1.0/-0	80.0 ±1.0	100 ±1.0	60.0 +1.0/-0

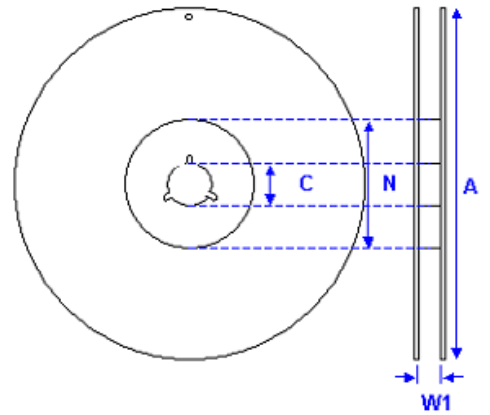

10. 产品使用说明

序号	项目	说明												
10.1.	存储	<p>1. 为防止端电极的可焊性遭到破坏，建议储存条件如下： 室内环境：温度：5~40℃ / 湿度：20%~70%RH。 应避免电容器在硫酸、氨、硫化氢或氯等腐蚀性环境中存放。</p> <p>2. 在使用电容器之前，不应打开包装。如果打开，包装应在切实可行的范围内尽快重新密封。</p> <p>3. 卷装包装或散装包装产品不可存放在阳光直射的环境中。这可能会造成包材老化或胶带附着性能恶化，甚至造成产品端电极氧化失效。</p> <p>4. 建议产品自交货后 12 个月内使用完毕，使用前检测可焊性。</p>												
10.2.	使用处理	<p>积层陶瓷电容的材料具有密度高、坚硬、易碎、易磨损等特性，容易受机械作用损坏造成破损或裂痕。因此元件必须小心使用，避免污染或碰撞。建议使用真空吸取或塑胶夹具取放元件。载带包装的卷装产品适用于自动化生产。</p>												
10.3.	作业预热处理	<p>为了降低及避免焊接过程中的温度热冲击影响，需要控制预热温度条件，预热区段的温度升温速度不可大于 3℃。</p>												
10.4.	焊锡作业	<p>作业时应使用无活性松香助焊剂和弱活性松香助焊剂，切勿使用活性助焊剂。 为防止因焊料引起芯片和基板之间的应力影响而造成元件的损坏，作业中必须衡量并控制每个焊点的焊料使用比率。</p> <p>1.人工焊接作业标准：</p> <div style="border: 1px solid black; padding: 5px;"> <p style="text-align: center;">人工焊接温度曲线</p> </div> <table border="1" style="width: 100%; border-collapse: collapse; text-align: center;"> <thead> <tr> <th>芯片尺寸</th> <th>预热温度</th> <th>ΔT (温差)</th> <th>烙铁最高温度</th> </tr> </thead> <tbody> <tr> <td>≤1206</td> <td>≥150 °C</td> <td>≤150 °C</td> <td>≤350 °C</td> </tr> <tr> <td>1210~2225</td> <td>≥150 °C</td> <td>≤130 °C</td> <td>≤280 °C</td> </tr> </tbody> </table> <p>*烙铁末端直径需 ≤1.0mm，且加热功率不可大于 20 瓦。 *芯片必须用烙铁末端在未接触元件的情况下以适合的温度曲线进行预热。 *欲焊接的锡必须先附在烙铁末端再进行焊接，且烙铁不可直接接触芯片本体。 *焊接后元件必须在常温中自然冷却，切勿借助外力强制吹风冷却。</p>	芯片尺寸	预热温度	ΔT (温差)	烙铁最高温度	≤1206	≥150 °C	≤150 °C	≤350 °C	1210~2225	≥150 °C	≤130 °C	≤280 °C
芯片尺寸	预热温度	ΔT (温差)	烙铁最高温度											
≤1206	≥150 °C	≤150 °C	≤350 °C											
1210~2225	≥150 °C	≤130 °C	≤280 °C											

10. 产品使用摘要

序号	项目	说明																																																		
10.4.	焊锡作业	<p>2. 回流焊接作业标准:</p> <p>温度 (°C)</p> <p>时间 (秒)</p> <p>最大升温速率 3°C/秒 最大降温速率 6°C/秒</p> <p>60~120 秒</p> <p>最长 30 秒 最短 30 秒</p> <p>60~150 秒</p> <p>锡 / 银 / 铜 材质 适用焊锡膏 (无铅)</p>																																																		
		<p>3. 波峰焊接作业标准:</p> <p>温度 (°C)</p> <p>时间 (秒)</p> <p>最大升温速率 150°C/秒 最大降温速率 4°C/秒</p> <p>40~80 秒</p> <p>3~5 秒</p> <p>自然冷却大于 60 秒</p> <p>锡 / 银 / 铜 材质 适用焊锡膏 (无铅)</p>																																																		
		<p>4. 焊接作业方式适用性:</p> <table border="1"> <thead> <tr> <th rowspan="2">芯片尺寸</th> <th rowspan="2">介电类别.</th> <th rowspan="2">电容量</th> <th colspan="2">作业方式</th> </tr> <tr> <th>波峰焊</th> <th>回流焊</th> </tr> </thead> <tbody> <tr> <td>0402</td> <td>1 类</td> <td>全范围</td> <td>X</td> <td>○</td> </tr> <tr> <td>0603~1206</td> <td>1 类</td> <td>全范围</td> <td>○</td> <td>○</td> </tr> <tr> <td>≥1210</td> <td>1 类</td> <td>全范围</td> <td>X</td> <td>○</td> </tr> <tr> <td>0402</td> <td>2 类</td> <td>全范围</td> <td>X</td> <td>○</td> </tr> <tr> <td rowspan="2">0603</td> <td>2 类</td> <td>Cap. < 2.2μF</td> <td>○</td> <td>○</td> </tr> <tr> <td>2 类</td> <td>Cap. ≥ 2.2μF</td> <td>X</td> <td>○</td> </tr> <tr> <td rowspan="2">0805~1206</td> <td>2 类</td> <td>Cap. < 4.7μF</td> <td>○</td> <td>○</td> </tr> <tr> <td>2 类</td> <td>Cap. ≥ 4.7μF</td> <td>X</td> <td>○</td> </tr> <tr> <td>≥1210</td> <td>2 类</td> <td>全范围</td> <td>X</td> <td>○</td> </tr> </tbody> </table>	芯片尺寸	介电类别.	电容量	作业方式		波峰焊	回流焊	0402	1 类	全范围	X	○	0603~1206	1 类	全范围	○	○	≥1210	1 类	全范围	X	○	0402	2 类	全范围	X	○	0603	2 类	Cap. < 2.2μF	○	○	2 类	Cap. ≥ 2.2μF	X	○	0805~1206	2 类	Cap. < 4.7μF	○	○	2 类	Cap. ≥ 4.7μF	X	○	≥1210	2 类	全范围	X	○
		芯片尺寸				介电类别.	电容量	作业方式																																												
波峰焊	回流焊																																																			
0402	1 类	全范围	X	○																																																
0603~1206	1 类	全范围	○	○																																																
≥1210	1 类	全范围	X	○																																																
0402	2 类	全范围	X	○																																																
0603	2 类	Cap. < 2.2μF	○	○																																																
	2 类	Cap. ≥ 2.2μF	X	○																																																
0805~1206	2 类	Cap. < 4.7μF	○	○																																																
	2 类	Cap. ≥ 4.7μF	X	○																																																
≥1210	2 类	全范围	X	○																																																

10.产品使用摘要

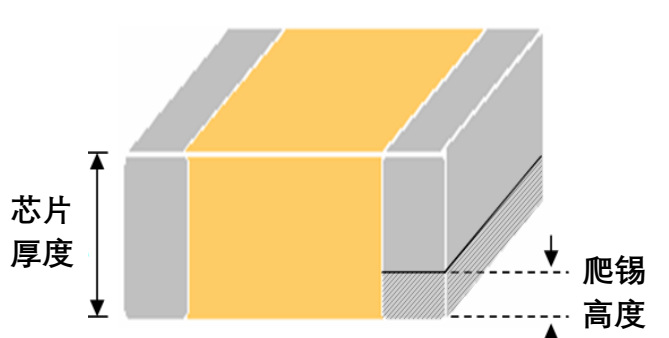
序号	项目	说明
10.4.	焊锡作业	<p>5.爬锡高度:</p> <p>建议最小爬锡高度至少 1/4 芯片厚度,或是 500um 高度水准.取任一较小值(以上判定参照 IPC-610E)</p> 
		<p>5. .冷却处理: 焊锡后芯片及基板的冷却必须在自然降温的方式进行。 建议在常温中自然降温以缓和应力的影响。</p> <p>6.清洁: 所有助熔剂残留物必须使用合适的电子级蒸汽清洗溶剂去除，以消除可能导致电解表面腐蚀的污染。采用超声波清洗溶剂可获得较好的清洗效果。选择合适的清洁系统取决于多种因素，如组分配比、焊剂、焊膏和组装方法等。清洗系统从芯片下面去除助熔剂、残留物和污染的能力是非常重要的。</p>

X-ON Electronics

Largest Supplier of Electrical and Electronic Components

Click to view similar products for [Multilayer Ceramic Capacitors MLCC - SMD/SMT](#) category:

Click to view products by [HUIJU](#) manufacturer:

Other Similar products are found below :

[M39014/02-1225V](#) [M39014/22-0631](#) [D55342E07B523DR-T/R](#) [NCA1206X7R103K50TRPF](#) [NCA1206X7R104K16TRPF](#) [NIN-FC2R7JTRF](#)
[NMC0402NPO220J50TRPF](#) [NMC0402X5R105K6.3TRPF](#) [NMC0402X5R224K6.3TRPF](#) [NMC0402X7R103J25TRPF](#)
[NMC0402X7R392K50TRPF](#) [NMC0603NPO201J50TRPF](#) [NMC0603X7R333K16TRPF](#) [NMC0805NPO820J50TRPF](#)
[NMC0805X7R224K16TRPLPF](#) [NMC1206X7R102K50TRPF](#) [NMC1206X7R106K10TRPLPF](#) [NMC1206X7R475K10TRPLPF](#) [NMC-](#)
[Q0402NPO8R2D200TRPF](#) [C1608C0G2A221J](#) [C1608X7R1E334K](#) [C2012C0G2A472J](#) [2220J2K00562KXT](#) [CDR33BX104AKUR](#)
[CDR33BX683AKUS](#) [CGA3E1X7R1C684K](#) [CL10C0R8BB8ANNC](#) [C1005X5R0G225M](#) [C2012X7R2E223K](#) [C3216C0G2J272J](#)
[D55342E07B35E7R-T/R](#) [NMC0402X7R562J25TRPF](#) [NMC0603NPO102J25TRPF](#) [NMC1206X7R332K50TRPF](#) [726632-1](#)
[CGA6M3X7R1H225K](#) [CGA5L2X7R2A105K](#) [CGA3E2X8R1H223K](#) [CDR33BX823AKUR\M500](#) [CDR35BX474AKUR\M500](#)
[CDR35BX104BKUR\M500](#) [69995D](#) [NMC0201X5R473K6.3TRPF](#) [NMC0201X7R221K25TRPF](#) [NMC0402X5R105K10TRPF](#)
[NMC0402X5R224K10TRPF](#) [NMC0603X7R104J25TRPF](#) [NMC0603X7R223K25TRPF](#) [NMC0805NPO100J50TRPF](#)
[NMC0805X7R104M50TRPF](#)