



GENERAL SPECIFICATIONS (电气特性)

1. Series model: (系列号)	SMD3068
2. Normal Frequency: (标称频率)	32.768000KHz
3. Oscillation Mode: (振动模式)	<input checked="" type="checkbox"/> Fundamental <input type="checkbox"/> 3rd
4. Load Capacitance(CL): (负载电容)	12.5 PF
5. Frequency Tolerance 25±3℃: (频率偏差 25±3℃)	±20PPM
6. Stability Over Temperature Range: (工作温度频率偏差)	±30 PPM at -40℃ to+85℃
7. Effective Series Resistance: (等效电阻)	≤ 70 KΩ
8. Shunt Capacitance(C0): (静态电容)	≤ 3 PF
9. Typical drive level: (激励功率)	10uW TYP.
10. Operation Temperature Range: (工作温度范围)	-40℃ to +85℃
11. Storage Temperature: (存储温度)	-55℃ to +125℃
12. Insulation Resistance: (绝缘阻抗)	≥500 MΩ at DC 100V
13. Aging: (老化率)	±3 PPM/Year
14. Leak (检漏)	1×10 ⁻⁷ Torr.1/sec Max
15. Test circuit (测试仪器)	S&A 250B Pi-Network Crystal Measurement System

Remark (备注):

晶振最佳储存条件: 温度: 25±5℃, 湿度: <70%。

密封包装, 切勿挤压, 切勿在 30cm 以上的高度滑落跌落。

DIMENSIONS SPECIFICATIONS (外形尺寸)

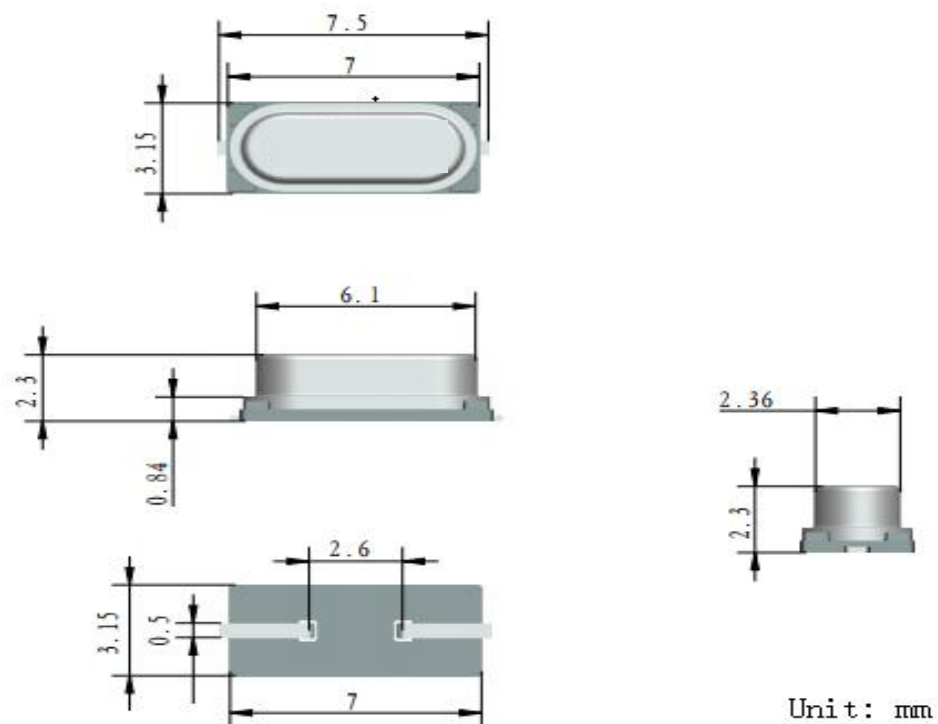

MARKING SPECIFICATION (印字)

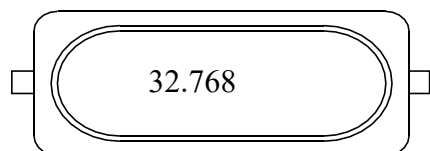

注意:

32.768 为额定频率 (KHz),



PACKING (包装)

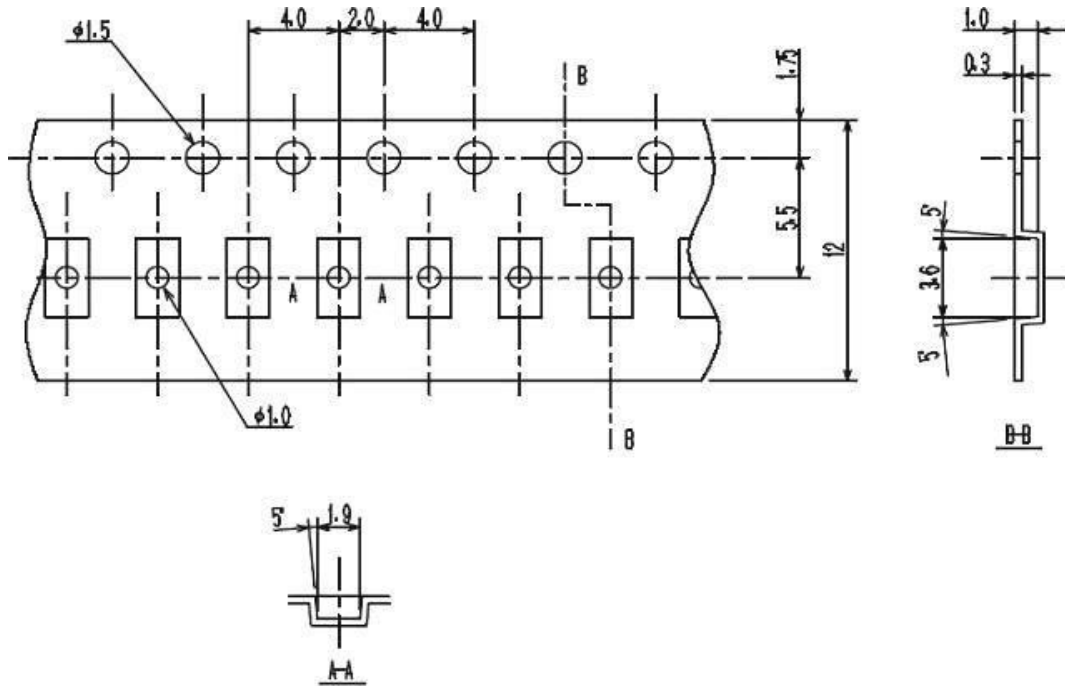

Reel Dimensions(unit: mm)

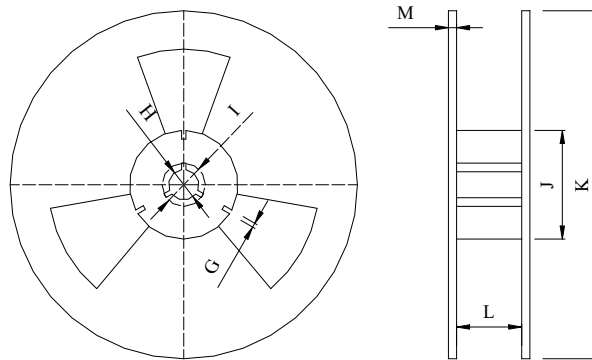

Unit : mm

Standard Reel Quantity is **3000 pcs** per Reel.

X-ON Electronics

Largest Supplier of Electrical and Electronic Components

Click to view similar products for [Crystals](#) category:

Click to view products by [Huiyuan crystal](#) manufacturer:

Other Similar products are found below :

[CX3225GB25000M0PPSZ1](#) [718-13.2-1](#) [7A-40.000MAAE-T](#) [FL2000085](#) [99-BU](#) [9B-15.360MBBK-B](#) [9C-7.680MBBK-T](#) [H10S-12.000-18-EXT-TR](#) [ABC2-6.000MHZ-D4Z-T](#) [ABLS-20.000MHZ-D2-T](#) [ABS071-32.768KHZ-6-T](#) [R38-32.768-12.5-5PPM-NPB](#) [BTD1062E05A-513](#) [21U15A-21.4MHZ](#) [RTX-781DF1-S-20.950](#) [LFXTAL066198Cutt](#) [9C-14.31818MBBK-T](#) [A-11.000MHZ-27](#) [ABL-27.000MHZ-B4Y-T](#) [ABM11-132-24.000MHZ-T3](#) [ABM3B1-25.000MHZ-D2Y-T](#) [SPT2A-.032768B](#) [SPT2A.032768G](#) [LFXTAL065253Cutt](#) [LFXTAL066431Cutt](#) [XT9S20ANA14M7456](#) [XT9SNLANA16M](#) [7A-24.576MBBK-T](#) [7B-30.000MBBK-T](#) [CX2520DB16000H0HPQCC](#) [MMCC2R32.7680KHZ](#) [6504-202-1501](#) [6526-202-1501](#) [ABLS-12.000MHZ-B2Y-T](#) [7A-10.000MBBK-T](#) [SG636PCE-20.000MC](#) [3404](#) [CM315D32768EZFT](#) [C1E-24.000-7-2020-R](#) [C1E-19.200-12-1530-X-R](#) [C1E-16.000-12-1530-X-R](#) [ABM11-16.000MHZ-9-B1U-T](#) [FL5000014](#) [EUCA18-3.1872M](#) [FX0800015](#) [425F35E027M0000](#) [FP0800018](#) [MS3V-T1R-32.768kHz-7pF-20PPM-TA-QC-Au](#) [VXM7-1C1-16M000](#) [MS3V-T1R-32.768kHz-9pF-20PPM-TA-QC-Au](#)