

CABLE GLANDS





HUMMEL — smart & reliable



HUMMEL AG is a renowned manufacturer of connection technology and components for electric and heating areas. The medium sized family business stands for quality, precision, reliability and pronounced service consciousness. A wide vertical range of manufacture with in-house development, construction, toolmaking, manufacturing, electroplating and assembling from a single source, offers best conditions for implementing individual solutions.



connections

Table of content	Page
Introduction	6
Plastic cable glands	13
HSK-K.....	14
HSK-K-Multi.....	19
HSK-K-Flaka.....	20
HSK-K-PVDF.....	21
HSK-K-Flex.....	24
HSK-W / HSK-W rotating version.....	26
HSK-W-Flex.....	28
HSK-KE.....	29
HSK-KR.....	30
Metal cable glands	31
HSK-M / HSK-M-PVDF.....	32
HSK-M-Multi.....	37
HSK-M-Flaka.....	38
HSK-M-Flex.....	39
HSK-M-W.....	42
HSK-MZ / HSK-MZ-PVDF.....	43
HSK-Mini.....	45
HSK-XL.....	46
HSK-INOX / HSK-INOX-PVDF.....	47
WADI-A-FKM.....	50
EMC cable glands	51
HSK-M-EMC-D.....	52
METRICA-M-EMC-E.....	54
HSK-M-EMC / HSK-M-PVDF-EMC.....	55
HSK-M-Flex-EMC.....	57
HSK-MZ-EMC.....	59
HSK-INOX-EMC.....	60
Cable glands for special applications	61
VariaPro Rail.....	62
VariaPro Temp.....	63
VariaPro FKM.....	64
HSK-INOX-HD.....	65
HSK-INOX-HD-Pro.....	66
DIN cable glands	67
DIN 46320.....	68
Z (DIN 46320).....	69
SE (DIN 46320).....	72
ZSE (DIN 46320).....	72
Accessories	73

Table of content	Page
Ex cable glands	103
Ex e plastic cable glands	
HSK-K-Ex-Active	104
HSK-K-Multi-Ex-Active	106
HSK-K-Flaka-Ex-Active	107
HSK-K-MZ-Ex.....	108
Ex e metal cable glands	
HSK-M-Ex / HSK-M-PVDF-Ex	110
HSK-M-Multi-Ex	114
HSK-M-Flaka-Ex.....	115
HSK-MZ-Ex / HSK-MZ-PVDF-Ex	116
HSK-INOX-Ex / HSK-INOX-PVDF-Ex.....	117
Ex d metal cable glands	
HSK-M-Ex d / HSK-M-PVDF-Ex d.....	118
HSK-MZ-Ex d.....	119
HSK-INOX-Ex d / HSK-INOX-PVDF-Ex d	120
EMC-Ex e cable glands	121
HSK-M-EMC-D-Ex	122
HSK-M-EMC-Ex / HSK-M-EMC-PVDF-Ex.....	124
HSK-MZ-EMC-Ex / HSK-MZ-EMC-PVDF-Ex	126
HSK-INOX-EMC-Ex.....	128
Ex accessories	129
EXIOS cable glands for „Hazardous Areas“	141
EXIOS Standard	142
EXIOS MZ	144
EXIOS Barrier.....	146
EXIOS A2F	148
EXIOS accessories	149
Technical information	151
Assembly instructions	154
Index numerical and alphabetical	156
HUMMEL international	160

INDUSTRIAL CABLE GLANDS MADE OF PLASTIC AND METAL

The right solution for every application

HUMMEL offers a huge portfolio of cable glands for industrial applications. Plastic, brass and stainless steel glands in many different sizes and variants. The products are backed up by all relevant certification. This gives the customers the security they need for a wide range of uses.

- // Conforming to RoHS and REACH / SVHC
- // Free of conflict materials
- // Halogen- and phosphorus-free
- // Fire protection class V0 according to UL 94

- // Outdoor durable polyamide according to UL 746C f1 (HSK-K black)
- // Protection IP 66 and IP 68 – 10 bar according to DIN EN 60529
- // Protection IP 69K according to DIN 40050-9
- // Patented ratchet and spline secures the dome nut on the body

HSK-K

Flexible overlapping clamping splines prevent the form seal from being pulled out of the fitting

The form seal allows for an IP 68 (10 bar) rating

The rugged lead screw results in a dependable transmission of force between nut and body

The concentric seal ridge and molded groove for an optional O-Ring results in a liquid tight seal between body and housing

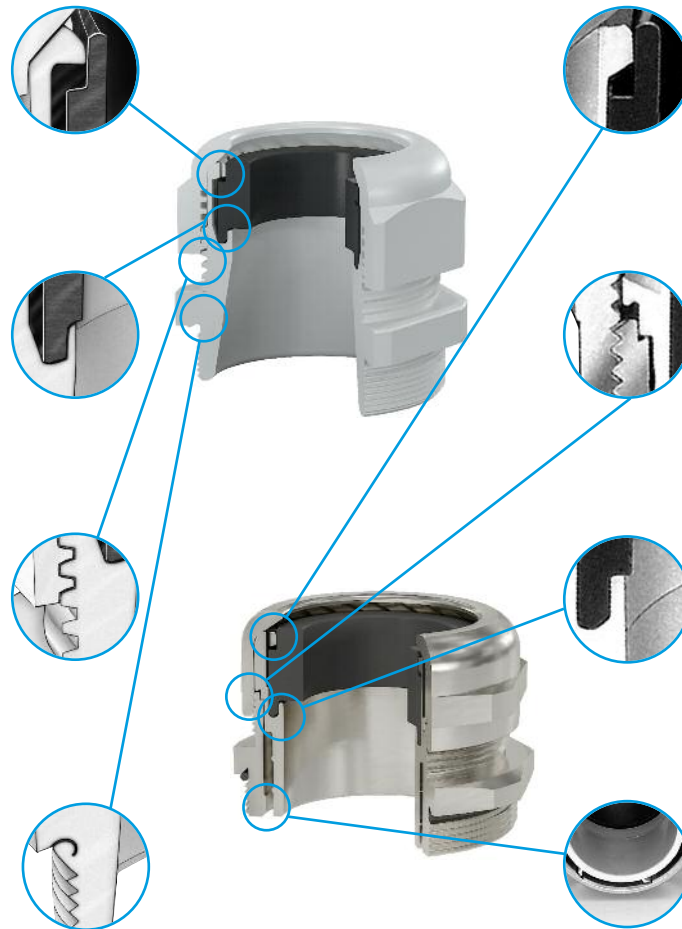

HSK-M

Flexible overlapping clamping splines prevent the form seal from being pulled out of the fitting

The internal sealing edge results in a superior seal between the splined Nylon clamping insert and the nickel plated brass body

The form seal allows for an IP 68 (10 bar) rating

Rotation of the cable during installation is prevented due to the internal splines

INDUSTRIAL CABLE GLANDS WITH EMC PROTECTION

All-round security: 360° EMC connection

As a premium manufacturer, HUMMEL relies on high-quality materials and innovative technology. In particular when it involves an EMC connection, users can rely on long-lasting protection. Measurements prove that HUMMEL cable glands with a metallic clamp insert provide secure EMC protection even after many years of use.

- // Conforming to RoHS and REACH / SVHC
- // Free of conflict materials
- // Halogen- and phosphorus-free
- // Fire protection class V0 according to UL 94

- // Protection IP 66 and IP 68 – 10 bar according to DIN EN 60529
- // Protection IP 69K according to DIN 40050-9
- // Quick assembly and reliable grounding of shielded cables

HSK-M-EMC

Flexible overlapping clamping splines prevent the form seal from being pulled out of the fitting

The internal sealing edge results in a superior seal between the splined Nylon clamping insert and the nickel plated brass body

Patented 360° grounding due to the internal O-Ring, which results in a perfect contact between braided shield of cable and fitting

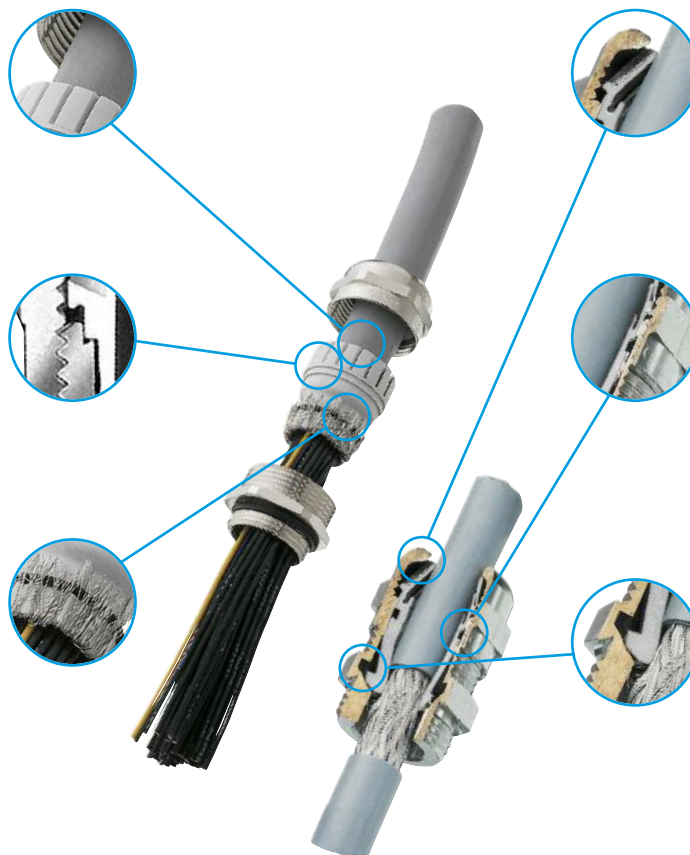

HSK-M-EMC-D

Flexible overlapping clamping splines prevent the form seal from being pulled out of the fitting

Metallized spline insert provides electrical conductivity

Flexible contact points allow contact with variable braid diameters

CABLE GLANDS FOR SPECIAL APPLICATIONS

VariaPro Rail: Meets all requirements for use in rail transportation

VariaPro Rail cable gland has successfully passed the tests of the fire protection standards DIN EN 45545-2 and DIN EN 45545-3. Thus it can be used without restrictions in all trains on the European rail network. The slim structure meets the requirement for a space saving installation. Added to this is the ease of installation of the cable gland.

- // EMC connection as standard
- // High fire protection
- // Seal: EPDM

- // Extremely high strain relief
- // Big clamping range due to reducers
- // No twisting of inserts and cables

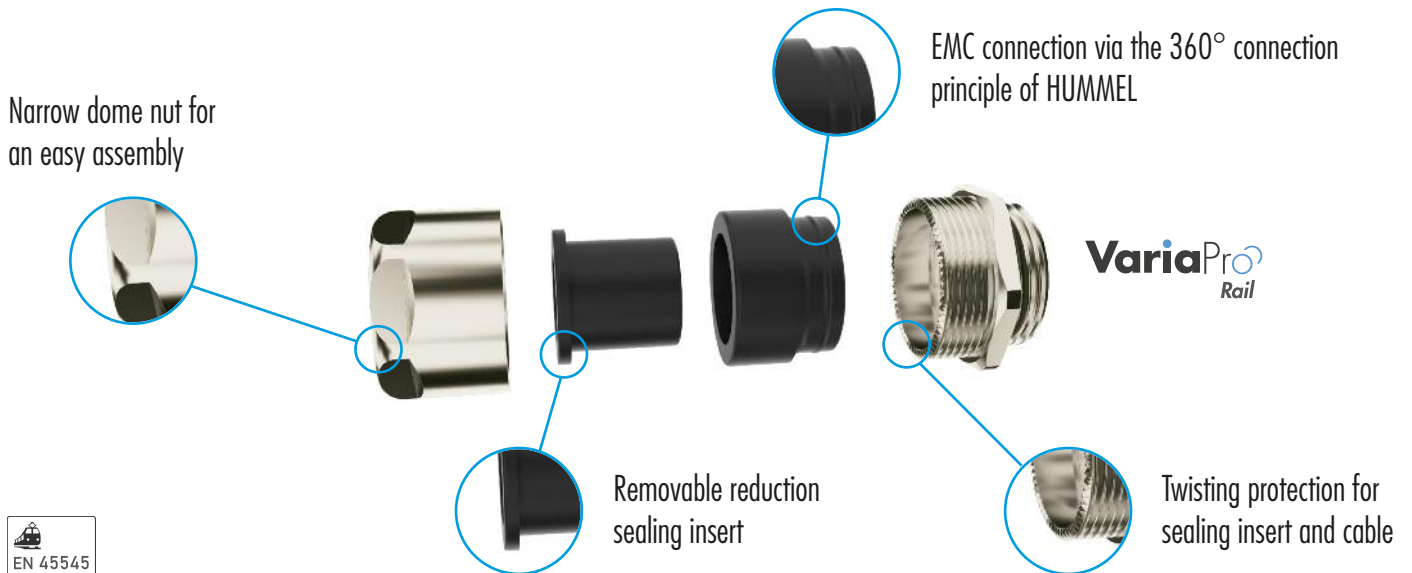

VariaPro Temp

VariaPro Temp products have been designed specially for applications under extreme temperature conditions. These cable glands function reliably in a temperature range from -60° to +200° C.



VariaPro FKM

The VariaPro FKM cable glands feature extremely high resistance properties against the influence of chemicals, acids or cleaning agents.



CABLE GLANDS FOR SPECIAL APPLICATIONS

HSK-INOX-HD / HSK-INOX-HD-Pro: Cope with all hygienic requirements

The hygienic design cable glands have been developed for applications with special requirements. They are used in areas where high hygienic standards for cleaning and chemical resistance are demanded. These are areas where deposits of bacteria and microorganisms need to be avoided.

Fields of application

- // Food industry
- // Pharma / chemical industry
- // Biotechnical plants
- // Packaging machinery

HSK-INOX-HD-Pro

- // EHEDG-certified
- // High-pressure tested (IP 69K)
- // Free of halogens and phosphate

HSK-INOX-HD-Pro

The elastic membrane sealing avoids cable slipping

Easy cleaning, because of missing corners and edges.

Resistant enclosure made of stainless steel (EN 1.4404 / AISI 316L)

High-quality silicone sealing

High strain relief

360° EMC contacting

Connection thread M 12 to M 32

No twisting of seal inserts and cables

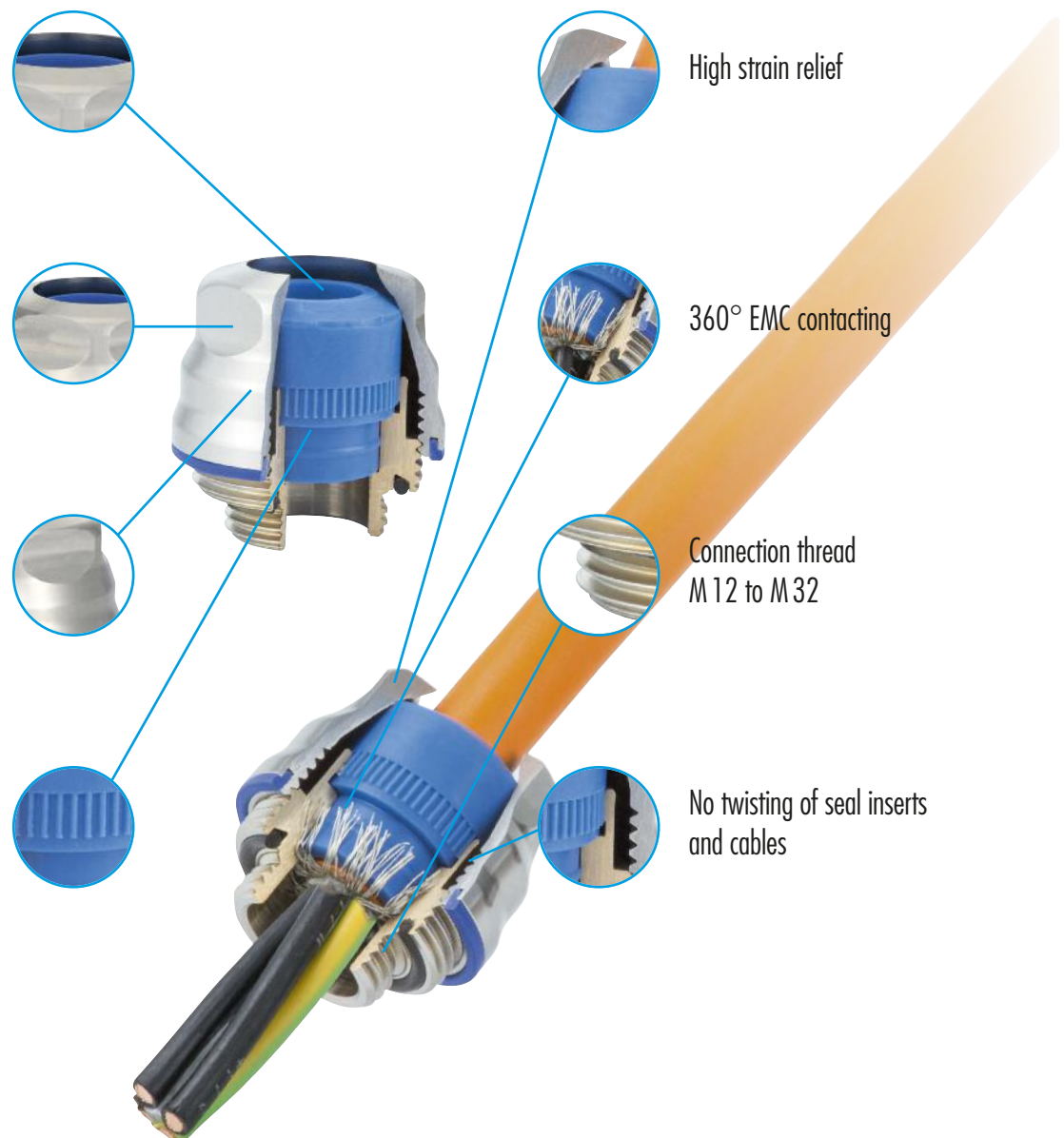

CABLE GLANDS FOR HAZARDOUS AREAS

Polyamide cable glands for hazardous areas

This cable gland, made of special formulated fibre glass reinforced polyamide has been designed for applications in electrical equipment, which require types of protection Ex e and Ex t according to the latest standards EN 60079-0, 60079-7 and 60079-31 and meets the latest approvals according to ATEX and IECEx.

- // Halogen-free
- // Protection IP 68 – 10 bar according to DIN EN 60529
- // Vibration-protected dome nut
- // Wide clamping range
- // Applicable up to +85° C (185° F)
- // Abrasion resistant marking
- // O-Ring as standard
- // Applicable in zone 1 – 2 and zone 20 – 22

HSK-K-Ex-Active

Overlapping clamping splines ensure an extremely high integrated strain-relief

Form seal for reliable sealing at protection class IP 68 up to 10 bar

HUMMEL trapezoidal thread for dependable transmission of force between dome nut and gland body



Molded O-Ring groove results in a reliable tightening between gland body and installation

Molded O-Ring groove results in a reliable tightening between gland body and installation

CABLE GLANDS FOR „HAZARDOUS AREAS“

EXIOS combats even particularly severe environments

EXIOS is at home in areas at risk of explosion, in particularly severe environments. This range of cable glands is used in refineries, chemical plants, in gas distribution and in offshore or marine applications. They meet the highest level of reliability, tension relief and sealing performance. EXIOS is available in all common connection thread types for reinforced and non-reinforced cables.

- // EXIOS Standard for reinforced cables in severe environments
- // EXIOS MZ with extra tension relief
- // EXIOS Barrier with compound cast encapsulation
- // EXIOS A2F for non-reinforced cables in explosion areas
- // Certified to IECEx and ATEX standards
- // Approved for Ex d, Ex e and Ex ta environments
- // Material: Brass, nickel-plated brass (INOX upon request)
- // Available sizes from M16 to M75





CABLE PROTECTION SYSTEMS

Reliable protection for cables

Cables and data leads are exposed to very high levels of stress in industrial applications. Heat and cold, tension and pressure, plus abrasion, all damage the leads and can lead to malfunction and production downtime. HUMMEL cable protection conduits offer reliable protection. The cable protection range is as versatile as a chameleon. The polyamide plastic series and metal protection conduits deliver the right solution for every application. A wide selection of fittings makes it easy for planners and designers to find the right solution for every challenge.

Polyamide

- // **Polyamide conduit** – the flexible polyamide cable conduit
- // **Polyamide fitting** – fittings for polyamide cable protection conduits, appropriate for all installation conditions

Metal

- // **Metal conduit** – resilient shaft conduit made of nickel-plated steel
- // **Metal fitting** – ideal for all metal protection conduits

- // **Metal conduit pro** – multi-layer version for greater demands
- // **Metal fitting pro** – fittings for metal conduits in particularly robust applications



PLASTIC CABLE GLANDS

HUMMEL HSK-K series cable glands lie in the premium segment and meet the highest demands for quality and safety. When it comes to fire protection, sealing ability and impact resistance, numerous certifications prove performance at the highest level. HUMMEL customers can rely on this.

In this chapter, you will find:

- // HSK-K: Polyamide cable glands
- // HSK-K-PVDF: Cable glands for use at high temperatures
- // HSK-K-Multi: Glands for applications with several cables
- // HSK-K-Flaka: with fitting for flat cables
- // HSK-K-Flex: offers bending protection for dynamic applications
- // HSK-W: Versions with a folding bracket for mounting with 90° cabling

In each case, HUMMEL offers different clamping areas, thread lengths, thread types and various sealing materials for different temperature ranges. The cable glands have all relevant approvals for international markets and a wide range of sectors.





Material	Polyamide VO according to UL 94
Seal	Buna-N
Protection	IP 68 – 10 bar / IP 69K (NEMA 6 – 150 PSIG) with additional O-Ring
Operating Temperature	-40 °C – 100 °C (-40 °F – 212 °F)
Colors	grey (RAL 7035), black (RAL 9005), blue (RAL 5012) for the intrinsic safety „i“



- // With additional pre-assembled O-Ring upon request
- // Suitable O-Ring on page 88
- // Other sealing materials e.g. silicone upon request
- // Other colors upon request

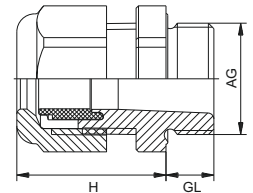

AG	∅k mm	GL mm	H mm	⌀ mm	Number grey	Number black	Number blue
M 12 x 1,5	3–6,5	8	21	15	1.209.1200.50	1.209.1201.50	1.209.1202.50
M 12 x 1,5	2–5	8	21	15	1.209.1200.51	1.209.1201.51	1.209.1202.51
M 16 x 1,5	4–8	8	22	19	1.209.1600.50	1.209.1601.50	1.209.1602.50
M 16 x 1,5	2–6	8	22	19	1.209.1600.51	1.209.1601.51	1.209.1602.51
M 16 x 1,5	5–10	8	25	22	1.219.1600.50	1.219.1601.50	1.219.1602.50
M 20 x 1,5	6–12	9	27	24	1.209.2000.50	1.209.2001.50	1.209.2002.50
M 20 x 1,5	5–9	9	27	24	1.209.2000.51	1.209.2001.51	1.209.2002.51
M 20 x 1,5	10–14	9	28	27	1.219.2000.50	1.219.2001.50	1.219.2002.50
M 25 x 1,5	13–18	11	31	30	1.219.2500.50	1.219.2501.50	1.219.2502.50
M 25 x 1,5	13–18	11	31	33	1.209.2500.50	1.209.2501.50	1.209.2502.50
M 25 x 1,5	9–16	11	31	33	1.209.2500.51	1.209.2501.51	1.209.2502.51
M 32 x 1,5	15–21	11	39	36	1.219.3200.50	1.219.3201.50	1.219.3202.50
M 32 x 1,5	18–25	11	39	42	1.209.3200.50	1.209.3201.50	1.209.3202.50
M 32 x 1,5	13–20	11	39	42	1.209.3200.51	1.209.3201.51	1.209.3202.51
M 40 x 1,5	19–27	13	47	46	1.219.4000.50	1.219.4001.50	1.219.4002.50
M 40 x 1,5	22–32	13	48	53	1.209.4000.50	1.209.4001.50	1.209.4002.50
M 40 x 1,5	20–26	13	48	53	1.209.4000.51	1.209.4001.51	1.209.4002.51
M 50 x 1,5	32–38	13	49	60	1.209.5000.50	1.209.5001.50	1.209.5002.50
M 50 x 1,5	25–31	13	49	60	1.209.5000.51	1.209.5001.51	1.209.5002.51
M 63 x 1,5	37–44	14	49	65 / 68	1.209.6300.50	1.209.6301.50	1.209.6302.50
M 63 x 1,5	29–35	14	49	65 / 68	1.209.6300.51	1.209.6301.51	1.209.6302.51

HSK-K

Metr.-elongated



Material	Polyamide VO according to UL 94
Seal	Buna-N
Protection	IP 68 – 10 bar / IP 69K (NEMA 6 – 150 PSIG) with additional O-Ring
Operating Temperature	-40 °C – 100 °C (-40 °F – 212 °F)
Colors	grey (RAL 7035), black (RAL 9005), blue (RAL 5012) for the intrinsic safety „i“



- // With additional pre-assembled O-Ring upon request
- // Suitable O-Ring on page 88
- // Other sealing materials e.g. silicone upon request
- // Other colors upon request

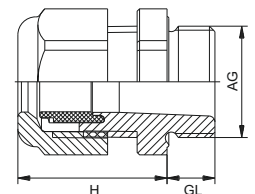

AG	\varnothing mm	GL mm	H mm	\varnothing mm	Number grey	Number black	Number blue
M 12 x 1,5	3–6,5	15	21	15	1.209.1200.30	1.209.1201.30	1.209.1202.30
M 12 x 1,5	2–5	15	21	15	1.209.1200.31	1.209.1201.31	1.209.1202.31
M 16 x 1,5	4–8	15	22	19	1.209.1600.30	1.209.1601.30	1.209.1602.30
M 16 x 1,5	2–6	15	22	19	1.209.1600.31	1.209.1601.31	1.209.1602.31
M 16 x 1,5	5–10	15	25	22	1.219.1600.30	1.219.1601.30	1.219.1602.30
M 20 x 1,5	6–12	15	27	24	1.209.2000.30	1.209.2001.30	1.209.2002.30
M 20 x 1,5	5–9	15	27	24	1.209.2000.31	1.209.2001.31	1.209.2002.31
M 20 x 1,5	10–14	15	28	27	1.219.2000.30	1.219.2001.30	1.219.2002.30
M 25 x 1,5	13–18	15	31	33	1.209.2500.30	1.209.2501.30	1.209.2502.30
M 25 x 1,5	9–16	15	31	33	1.209.2500.31	1.209.2501.31	1.209.2502.31
M 32 x 1,5	18–25	15	39	42	1.209.3200.30	1.209.3201.30	1.209.3202.30
M 32 x 1,5	13–20	15	39	42	1.209.3200.31	1.209.3201.31	1.209.3202.31
M 40 x 1,5	22–32	18	48	53	1.209.4000.30	1.209.4001.30	1.209.4002.30
M 40 x 1,5	20–26	18	48	53	1.209.4000.31	1.209.4001.31	1.209.4002.31
M 50 x 1,5	32–38	18	49	60	1.209.5000.30	1.209.5001.30	1.209.5002.30
M 50 x 1,5	25–31	18	49	60	1.209.5000.31	1.209.5001.31	1.209.5002.31
M 63 x 1,5	37–44	18	49	65/68	1.209.6300.30	1.209.6301.30	1.209.6302.30
M 63 x 1,5	29–35	18	49	65/68	1.209.6300.31	1.209.6301.31	1.209.6302.31



Material	Polyamide VO according to UL 94
Seal	Buna-N
Protection	IP 68 – 10 bar / IP 69K (NEMA 6 – 150 PSIG) with additional O-Ring
Operating Temperature	-40 °C – 100 °C (-40 °F – 212 °F)
Colors	grey (RAL 7035), black (RAL 9005), blue (RAL 5012) for the intrinsic safety „i“



- // With additional pre-assembled O-Ring upon request
- // Suitable O-Ring on page 88
- // Other sealing materials e.g. silicone upon request
- // Other colors upon request

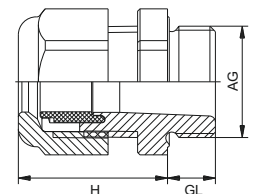

AG	$\varnothing k$ mm	GL mm	H mm	\varnothing mm	Number grey	Number black	Number blue
PG 7	3–6,5	8	21	15	1.209.0700.14	1.209.0701.14	1.209.0702.14
PG 7	2–5	8	21	15	1.209.0700.15	1.209.0701.15	1.209.0702.15
PG 9	4–8	8	22	19	1.209.0900.14	1.209.0901.14	1.209.0902.14
PG 9	2–6	8	22	19	1.209.0900.15	1.209.0901.15	1.209.0902.15
PG 11	5–10	8	25	22	1.209.1100.14	1.209.1101.14	1.209.1102.14
PG 11	3–7	8	25	22	1.209.1100.15	1.209.1101.15	1.209.1102.15
PG 13,5	6–12	9	27	24	1.209.1300.14	1.209.1301.14	1.209.1302.14
PG 13,5	5–9	9	27	24	1.209.1300.15	1.209.1301.15	1.209.1302.15
PG 16	10–14	10	28	27	1.209.1600.14	1.209.1601.14	1.209.1602.14
PG 16	7–12	10	28	27	1.209.1600.15	1.209.1601.15	1.209.1602.15
PG 21	13–18	11	31	33	1.209.2100.14	1.209.2101.14	1.209.2102.14
PG 21	9–16	11	31	33	1.209.2100.15	1.209.2101.15	1.209.2102.15
PG 29	18–25	11	39	42	1.209.2900.14	1.209.2901.14	1.209.2902.14
PG 29	13–20	11	39	42	1.209.2900.15	1.209.2901.15	1.209.2902.15
PG 36	22–32	13	48	53	1.209.3600.14	1.209.3601.14	1.209.3602.14
PG 36	20–26	13	48	53	1.209.3600.15	1.209.3601.15	1.209.3602.15
PG 42	32–38	13	49	60	1.209.4200.14	1.209.4201.14	1.209.4202.14
PG 42	25–31	13	49	60	1.209.4200.15	1.209.4201.15	1.209.4202.15
PG 48	37–44	14	49	65	1.209.4800.14	1.209.4801.14	1.209.4802.14
PG 48	29–35	14	49	65	1.209.4800.15	1.209.4801.15	1.209.4802.15

HSK-K

PG-elongated



Material	Polyamide VO according to UL 94
Seal	Buna-N
Protection	IP 68 – 10 bar / IP 69K (NEMA 6 – 150 PSIG) with additional O-Ring
Operating Temperature	-40 °C – 100 °C (-40 °F – 212 °F)
Colors	grey (RAL 7035), black (RAL 9005), blue (RAL 5012) for the intrinsic safety „i“



- // With additional pre-assembled O-Ring upon request
- // Suitable O-Ring on page 88
- // Other sealing materials e.g. silicone upon request
- // Other colors upon request

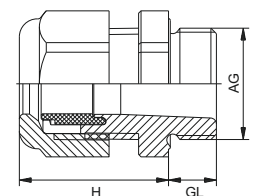

AG	∅k mm	GL mm	H mm	⌀ mm	Number grey	Number black	Number blue
PG 7	3–6,5	15	21	15	1.209.0700.60	1.209.0701.60	1.209.0702.60
PG 7	2–5	15	21	15	1.209.0700.61	1.209.0701.61	1.209.0702.61
PG 9	4–8	15	22	19	1.209.0900.60	1.209.0901.60	1.209.0902.60
PG 9	2–6	15	22	19	1.209.0900.61	1.209.0901.61	1.209.0902.61
PG 11	5–10	15	25	22	1.209.1100.60	1.209.1101.60	1.209.1102.60
PG 11	3–7	15	25	22	1.209.1100.61	1.209.1101.61	1.209.1102.61
PG 13,5	6–12	15	27	24	1.209.1300.60	1.209.1301.60	1.209.1302.60
PG 13,5	5–9	15	27	24	1.209.1300.61	1.209.1301.61	1.209.1302.61
PG 16	10–14	15	28	27	1.209.1600.60	1.209.1601.60	1.209.1602.60
PG 16	7–12	15	28	27	1.209.1600.61	1.209.1601.61	1.209.1602.61
PG 21	13–18	15	31	33	1.209.2100.60	1.209.2101.60	1.209.2102.60
PG 21	9–16	15	31	33	1.209.2100.61	1.209.2101.61	1.209.2102.61
PG 29	18–25	15	39	42	1.209.2900.60	1.209.2901.60	1.209.2902.60
PG 29	13–20	15	39	42	1.209.2900.61	1.209.2901.61	1.209.2902.61
PG 36	22–32	18	48	53	1.209.3600.60	1.209.3601.60	1.209.3602.60
PG 36	20–26	18	48	53	1.209.3600.61	1.209.3601.61	1.209.3602.61
PG 42	32–38	18	49	60	1.209.4200.60	1.209.4201.60	1.209.4202.60
PG 42	25–31	18	49	60	1.209.4200.61	1.209.4201.61	1.209.4202.61
PG 48	37–44	18	49	65	1.209.4800.60	1.209.4801.60	1.209.4802.60
PG 48	29–35	18	49	65	1.209.4800.61	1.209.4801.61	1.209.4802.61

PLASTIC CABLE GLANDS

HSK-K

NPT



Material	Polyamide VO according to UL 94
Seal	Buna-N
Protection	IP 68 – 10 bar / IP 69K (NEMA 6 – 150 PSIG) with additional O-Ring
Operating Temperature	-40 °C – 100 °C (-40 °F – 212 °F)
Colors	grey (RAL 7035), black (RAL 9005), blue (RAL 5012) for the intrinsic safety „i“



- // With additional pre-assembled O-Ring upon request
- // Suitable O-Ring on page 88
- // Other sealing materials e.g. silicone upon request
- // Other colors upon request

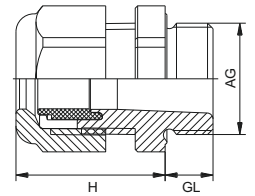

AG	\varnothing mm	GL mm	H mm	\varnothing mm	Number grey	Number black	Number blue
NPT 3/8"	4–8	15	22	19 / 22	1.209.3800.70	1.209.3801.70	1.209.3802.70
NPT 3/8"	2–6	15	22	19 / 22	1.209.3800.71	1.209.3801.71	1.209.3802.71
NPT 1/2"	6–12	13	27	24	1.209.1200.70	1.209.1201.70	1.209.1202.70
NPT 1/2"	5–9	13	27	24	1.209.1200.71	1.209.1201.71	1.209.1202.71
NPT 1/2" (16)	10–14	13	28	27	1.209.1216.70	1.209.1217.70	1.209.1218.70
NPT 1/2" (16)	7–12	13	28	27	1.209.1216.71	1.209.1217.71	1.209.1218.71
NPT 3/4"	13–18	14	31	33	1.209.3400.70	1.209.3401.70	1.209.3402.70
NPT 3/4"	9–16	14	31	33	1.209.3400.71	1.209.3401.71	1.209.3402.71
NPT 1"	18–25	19	39	42	1.209.1000.70	1.209.1001.70	1.209.1002.70
NPT 1"	13–20	19	39	42	1.209.1000.71	1.209.1001.71	1.209.1002.71
NPT 1 1/4"	18–25	16	39	42 / 46	1.209.5400.70	1.209.5401.70	1.209.5402.70
NPT 1 1/4"	13–20	16	39	42 / 46	1.209.5400.71	1.209.5401.71	1.209.5402.71
NPT 1 1/2"	22–32	20	48	53	1.209.6400.70	1.209.6401.70	1.209.6402.70
NPT 1 1/2"	20–26	20	48	53	1.209.6400.71	1.209.6401.71	1.209.6402.71

HSK-K-Multi

Metr., PG, NPT



Material	Polyamide VO according to UL 94
Seal	Elastomer
Protection	IP 65 / IP 68 with additional O-Ring
Operating Temperature	-40 °C – 100 °C (-40 °F – 212 °F)
Colors	grey (RAL 7035), black (RAL 9005)



- // With additional pre-assembled O-Ring upon request
- // Suitable O-Ring on page 88
- // Other sealing materials and colors upon request
- // Elongated threads upon request
- // Installation instructions see page 152
- // Further seal inserts on page 86 or upon request
- // The shown inserts are samples, more inserts (also customer specific) upon request

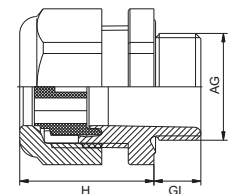

AG	GL mm	H mm	Ø mm	Number of holes x d	Number grey	Number black	Number of holes x d	Number grey	Number black
M 16 x 1,5	8	22	19	4 x 1,4	1.597.1600.50	1.597.1600.51	2 x 3	1.597.1601.50	1.597.1601.51
M 20 x 1,5	9	27	24	6 x 3	1.597.2001.50	1.597.2001.51	2 x 5	1.597.2003.50	1.597.2003.51
M 25 x 1,5	11	31	33	4 x 6	1.597.2500.50	1.597.2500.51	3 x 7	1.597.2501.50	1.597.2501.51
M 32 x 1,5	11	39	42	6 x 6,5	1.597.3200.50	1.597.3200.51	4 x 9	1.597.3201.50	1.597.3201.51
M 40 x 1,5	13	48	53	7 x 9	1.597.4001.50	1.597.4001.51	2 x 15	1.597.4003.50	1.597.4003.51
M 50 x 1,5	13	49	60		1.597.5099.50	1.597.5099.51			
M 63 x 1,5	14	49	65/68	6 x 12	1.597.6301.50	1.597.6301.51	3 x 18	1.597.6302.50	1.597.6302.51
PG 7	8	21	15		1.597.0799.00				
PG 9	8	22	19	4 x 1,4	1.597.0900.00	1.597.0900.01	2 x 3	1.597.0901.00	1.597.0901.01
PG 11	8	25	22	2 x 4	1.597.1102.00	1.597.1102.01	3 x 3	1.597.1101.00	1.597.1101.01
PG 13,5	9	27	24	3 x 4	1.597.1302.00	1.597.1302.01	2 x 5	1.597.1303.00	1.597.1303.01
PG 16	10	28	27	4 x 4	1.597.1602.00	1.597.1602.01	6 x 4	1.597.1604.00	1.597.1604.01
PG 16	10	28	27	3 x 5,6	1.597.1606.00	1.597.1606.01	2 x 6	1.597.1605.00	1.597.1605.01
PG 21	11	31	33	4 x 6	1.597.2100.00	1.597.2100.01	3 x 7	1.597.2101.00	1.597.2101.01
PG 29	11	39	42	6 x 6,5	1.597.2900.00	1.597.2900.01	4 x 9	1.597.2901.00	1.597.2901.01
PG 36	13	48	53	7 x 9	1.597.3601.00	1.597.3601.01	2 x 15	1.597.3603.00	1.597.3603.01
PG 42	13	49	60		1.597.4299.00				
PG 48	14	49	65	6 x 12	1.597.4801.00	1.597.4801.01	3 x 18	1.597.4802.00	1.597.4802.01
NPT 3/8"	15	22	19/22	4 x 1,4	1.597.3800.70	1.597.3800.71	2 x 3	1.597.3801.70	1.597.3801.71
NPT 1/2"	13	27	24	3 x 4	1.597.1202.70	1.597.1202.71	2 x 5	1.597.1203.70	1.597.1203.71
NPT 1/2" (16)	13	28	27	6 x 4	1.597.1220.70	1.597.1220.71	2 x 6	1.597.1221.70	1.597.1221.71
NPT 3/4"	14	31	33	4 x 6	1.597.3400.70	1.597.3400.71	3 x 7	1.597.3401.70	1.597.3401.71
NPT 1"	19	39	42	6 x 6,5	1.597.1000.70	1.597.1000.71	4 x 9	1.597.1001.70	1.597.1001.71
NPT 1 1/4"	16	39	42/46		1.597.5499.70	1.597.5499.71			
NPT 1 1/2"	20	48	53	5 x 9	1.597.6400.70	1.597.6400.71	7 x 9	1.597.6401.70	1.597.6401.71



Material	Polyamide VO according to UL 94
Seal	Elastomer
Protection	IP 65 / IP 68 with additional O-Ring
Operating Temperature	-40 °C – 100 °C (-40 °F – 212 °F)
Colors	grey (RAL 7035), black (RAL 9005)



- // With additional pre-assembled O-Ring upon request
- // Suitable O-Ring on page 88
- // Other sealing materials and colors upon request
- // Elongated threads upon request
- // Installation instructions see page 152
- // The shown inserts are samples, more inserts upon request

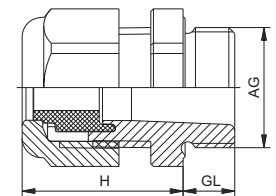

AG	GL mm	H mm	Ø mm	Dimensions w x h mm	Number grey	Number black	Dimensions w x h mm	Number grey	Number black
M 20 x 1,5	9	28	27	11,5 x 5	1.587.2016.50	1.587.2016.51	12 x 7	1.587.2017.50	1.587.2017.51
M 20 x 1,5	9	28	27	14 x 6	1.587.2018.50	1.587.2018.51			
M 25 x 1,5	11	31	33	14 x 6	1.587.2500.50	1.587.2500.51	14 x 7	1.587.2501.50	1.587.2501.51
M 32 x 1,5	11	39	42	22 x 8	1.587.3200.50	1.587.3200.51			
M 40 x 1,5	13	48	53	28,5 x 10	1.587.4000.50	1.587.4000.51	29 x 5,5	1.587.4001.50	1.587.4001.51
M 40 x 1,5	13	48	53	30,5 x 12	1.587.4002.50	1.587.4002.51	31 x 7,5	1.587.4003.50	1.587.4003.51
M 50 x 1,5	13	49	60	33,5 x 11,5	1.587.5000.50	1.587.5000.51			
M 63 x 1,5	14	49	65/68	38 x 12	1.587.6300.50	1.587.6301.51			
PG 16	10	28	27	11,5 x 5	1.587.1600.00	1.587.1600.01	12 x 7	1.587.1601.00	1.587.1601.01
PG 16	10	28	27	14 x 6	1.587.1602.00	1.587.1602.01			
PG 21	11	31	33	14 x 6	1.587.2100.00	1.587.2100.01	14 x 7	1.587.2101.00	1.587.2101.01
PG 29	11	39	42	22 x 8	1.587.2900.00	1.587.2900.01			
PG 36	13	48	53	28,5 x 10	1.587.3600.00	1.587.3600.01	29 x 5,5	1.587.3601.00	1.587.3601.01
PG 36	13	48	53	30,5 x 12	1.587.3602.00	1.587.3602.01	31 x 7,5	1.587.3603.00	1.587.3603.01
PG 42	13	49	60	33,5 x 11,5	1.587.4200.00	1.587.4200.01			
PG 48	14	49	65	38 x 12	1.587.4800.00	1.587.4800.01			
NPT 1/2" (16)	13	28	27	11,5 x 5,5	1.587.1216.70	1.587.1216.71	12 x 7	1.587.1217.70	1.587.1217.71
NPT 1/2" (16)	13	28	27	14 x 6	1.587.1218.70	1.587.1218.71			
NPT 3/4"	14	31	33	14 x 6	1.587.3400.70	1.587.3400.71			
NPT 1"	19	39	42	22 x 8	1.587.1000.70	1.587.1000.71			
NPT 1 1/4"	16	39	42/46	22 x 8	1.587.5400.70	1.587.5400.71			
NPT 1 1/2"	20	48	53	28,5 x 10	1.587.6400.70	1.587.6400.71	29 x 5,5	1.587.6401.70	1.587.6401.71
NPT 1 1/2"	20	48	53	30,5 x 12	1.587.6402.70	1.587.6402.71	31 x 7,5	1.587.6403.70	1.587.6403.71

HSK-K-PVDF

Metr.



Material	PVDF VO according to UL 94
Seal	FKM
Protection	IP 68 – 10 bar / IP 69K (NEMA 6 – 150 PSIG) with additional O-Ring
Operating Temperature	-35 °C – 150 °C (-31 °F – 302 °F)
Colors	nature



- // With additional pre-assembled O-Ring upon request
- // Suitable O-Ring on page 88
- // Other sealing materials e.g. silicone upon request
- // Other colors upon request

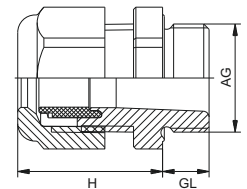

AG	∅ _k mm	GL mm	H mm	 mm	Number
M 12 x 1,5	3–6,5	8	21	15	1.299.1200.50
M 12 x 1,5	2–5	8	21	15	1.299.1200.51
M 16 x 1,5	4–8	8	22	19	1.299.1600.50
M 16 x 1,5	2–6	8	22	19	1.299.1600.51
M 20 x 1,5	6–12	9	27	24	1.299.2000.50
M 20 x 1,5	5–9	9	27	24	1.299.2000.51
M 25 x 1,5	13–18	11	31	33	1.299.2500.50
M 25 x 1,5	9–16	11	31	33	1.299.2500.51
M 32 x 1,5	18–25	11	39	42	1.299.3200.50
M 32 x 1,5	13–20	11	39	42	1.299.3200.51



Material	PVDF V0 according to UL 94
Seal	FKM
Protection	IP 68 – 10 bar / IP 69K (NEMA 6 – 150 PSIG) with additional O-Ring
Operating Temperature	-35 °C – 150 °C (-31 °F – 302 °F)
Colors	nature



- // With additional pre-assembled O-Ring upon request
- // Suitable O-Ring on page 88
- // Other sealing materials e.g. silicone upon request
- // Other colors upon request

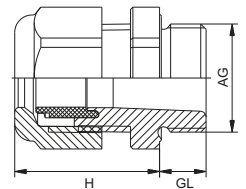

AG	∅k mm	GL mm	H mm	mm	Number
PG 7	3–6,5	8	21	15	1.299.0700.14
PG 7	2–5	8	21	15	1.299.0700.15
PG 9	4–8	8	22	19	1.299.0900.14
PG 9	2–6	8	22	19	1.299.0900.15
PG 11	5–10	8	25	22	1.299.1100.14
PG 11	3–7	8	25	22	1.299.1100.15
PG 13,5	6–12	9	27	24	1.299.1300.14
PG 13,5	5–9	9	27	24	1.299.1300.15
PG 16	10–14	10	28	27	1.299.1600.14
PG 16	7–12	10	28	27	1.299.1600.15
PG 21	13–18	11	31	33	1.299.2100.14
PG 21	9–16	11	31	33	1.299.2100.15
PG 29	18–25	11	39	42	1.299.2900.14
PG 29	13–20	11	39	42	1.299.2900.15
PG 36	22–32	13	48	53	1.299.3600.14
PG 36	20–26	13	48	53	1.299.3600.15
PG 42	32–38	13	49	60	1.299.4200.14
PG 42	25–31	13	49	60	1.299.4200.15
PG 48	37–44	14	49	65	1.299.4800.14
PG 48	29–35	14	49	65	1.299.4800.15

HSK-K-PVDF

NPT



Material	PVDF V0 nach UL 94
Seal	FKM
Protection	IP 68 – 10 bar / IP 69K (NEMA 6 – 150 PSIG) with additional O-Ring
Operating Temperature	-35 °C – 150 °C (-31 °F – 302 °F)
Colors	nature



- // With additional pre-assembled O-Ring upon request
- // Suitable O-Ring on page 88
- // Other sealing materials e.g. silicone upon request
- // Other colors upon request

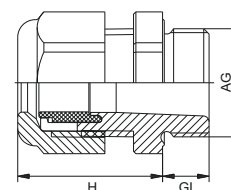

AG	∅ _k mm	GL mm	H mm	 mm	Number
NPT 3/8"	4 – 8	15	22	19 / 22	1.299.3800.70
NPT 3/8"	2 – 6	15	22	19 / 22	1.299.3800.71
NPT 1/2"	6 – 12	13	27	24	1.299.1200.70
NPT 1/2"	5 – 9	13	27	24	1.299.1200.71
NPT 1/2" (16)	10 – 14	13	28	27	1.299.1216.70
NPT 1/2" (16)	7 – 12	13	28	27	1.299.1216.71
NPT 3/4"	13 – 18	14	31	33	1.299.3400.70
NPT 3/4"	9 – 16	14	31	33	1.299.3400.71

PLASTIC CABLE GLANDS

HSK-K-Flex

Metr., Metr.-elongated



Material	Polyamide
Seal	NBR
Protection	IP 68 – 10 bar / IP 69K with additional O-Ring
Operating Temperature	-40 °C – 100 °C (-40 °F – 212 °F)
Colors	grey (RAL 7035), black (RAL 9005)

- // With additional pre-assembled O-Ring upon request
- // Suitable O-Ring on page 88
- // Other sealing materials e.g. silicone upon request
- // Other colors upon request



in black color

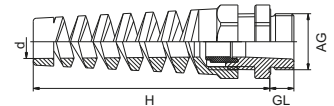

AG	Ø mm	d mm	H mm	 mm	GL mm	Number grey	Number black	GL mm	Number grey elelongated	Number black elelongated
M 12 x 1,5	3–6,5	7	54	15	8	1.293.1200.50	1.293.1201.50	15	1.293.1200.30	1.293.1201.30
M 12 x 1,5	2–5	7	54	15	8	1.293.1200.51	1.293.1201.51	15	1.293.1200.31	1.293.1201.31
M 16 x 1,5	4–8	8,5	63	19	8	1.293.1600.50	1.293.1601.50	15	1.293.1600.30	1.293.1601.30
M 16 x 1,5	2–6	8,5	63	19	8	1.293.1600.51	1.293.1601.51	15	1.293.1600.31	1.293.1601.31
M 16 x 1,5	5–10	10,5	78	22	8	1.294.1600.50	1.294.1601.50	15	1.294.1600.30	1.294.1601.30
M 16 x 1,5	3–7	10,5	78	22	8	1.294.1600.51	1.294.1601.51	15	1.294.1600.31	1.294.1601.31
M 20 x 1,5	6–12	13	90	24	9	1.293.2000.50	1.293.2001.50	15	1.293.2000.30	1.293.2001.30
M 20 x 1,5	5–9	13	90	24	9	1.293.2000.51	1.293.2001.51	15	1.293.2000.31	1.293.2001.31
M 20 x 1,5	10–14	15,5	100	27	9	1.294.2000.50	1.294.2001.50	15	1.294.2000.30	1.294.2001.30
M 20 x 1,5	7–12	15,5	100	27	9	1.294.2000.51	1.294.2001.51	15	1.294.2000.31	1.294.2001.31
M 25 x 1,5	13–18	20	114	33	11	1.293.2500.50	1.293.2501.50	15	1.293.2500.30	1.293.2501.30
M 25 x 1,5	9–16	20	114	33	11	1.293.2500.51	1.293.2501.51	15	1.293.2500.31	1.293.2501.31

HSK-K-Flex

PG, PG-elongated, NPT



Material	Polyamide
Seal	Buna-N
Protection	IP 68 – 10 bar / IP 69K with additional O-Ring
Operating Temperature	-40 °C – 100 °C
Colors	grey (RAL 7035), black (RAL 9005)



- // With additional pre-assembled O-Ring upon request
- // Suitable O-Ring on page 88
- // Other sealing materials e.g. silicone upon request
- // Other colors upon request

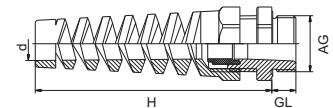

AG	∅ _k mm	d mm	H mm	mm	GL mm	Number grey	Number black	GL mm	Number grey elongated	Number black elongated
PG 7*	3–6,5	7	54	15	8	1.293.0700.14	1.293.0701.14	15	1.293.0700.60	1.293.0701.60
PG 7*	2–5	7	54	15	8	1.293.0700.15	1.293.0701.15	15	1.293.0700.61	1.293.0701.61
PG 9*	4–8	8,5	63	19	8	1.293.0900.14	1.293.0901.14	15	1.293.0900.60	1.293.0901.60
PG 9*	2–6	8,5	63	19	8	1.293.0900.15	1.293.0901.15	15	1.293.0900.61	1.293.0901.61
PG 11*	5–10	10,5	78	22	8	1.293.1100.14	1.293.1101.14	15	1.293.1100.60	1.293.1101.60
PG 11*	3–7	10,5	78	22	8	1.293.1100.15	1.293.1101.15	15	1.293.1100.61	1.293.1101.61
PG 13,5*	6–12	13	90	24	9	1.293.1300.14	1.293.1301.14	15	1.293.1300.60	1.293.1301.60
PG 13,5*	5–9	13	90	24	9	1.293.1300.15	1.293.1301.15	15	1.293.1300.61	1.293.1301.61
PG 16*	10–14	15,5	100	27	10	1.293.1600.14	1.293.1601.14	15	1.293.1600.60	1.293.1601.60
PG 16*	7–12	15,5	100	27	10	1.293.1600.15	1.293.1601.15	15	1.293.1600.61	1.293.1601.61
PG 21*	13–18	20	114	33	11	1.293.2100.14	1.293.2101.14	15	1.293.2100.60	1.293.2101.60
PG 21*	9–16	20	114	33	11	1.293.2100.15	1.293.2101.15	15	1.293.2100.61	1.293.2101.61
NPT 3/8"	4–8	8,5	63	22/19	15	1.293.3800.70	1.293.3801.70			
NPT 3/8"	2–6	8,5	63	22/19	15	1.293.3800.71	1.293.3801.71			
NPT 1/2"	6–12	13	90	24	13	1.293.1200.70	1.293.1201.70			
NPT 1/2"	5–9	13	90	24	13	1.293.1200.71	1.293.1201.71			
NPT 1/2" (16)	10–14	15,5	100	27	13	1.293.1216.70	1.293.1217.70			
NPT 1/2" (16)	7–12	15,5	100	27	13	1.293.1216.71	1.293.1217.71			
NPT 3/4"	13–18	20	114	33	14	1.293.3400.70	1.293.3401.70			
NPT 3/4"	9–16	20	114	33	14	1.293.3400.71	1.293.3401.71			

* Also available as KE-Flex with enlarged clamping range and as KR-Flex with reduced clamping range, see clamping range page 29

PLASTIC CABLE GLANDS

HSK-W

Metr.



// Other sealing materials e.g. silicone upon request
 // Other colors upon request

Material	Polyamide
Seal / O-Ring	Buna-N
Protection	IP 68
Operating Temperature	-40 °C – 100 °C (-40 °F – 212 °F)
Colors	grey (RAL 7035), black (RAL 9005)

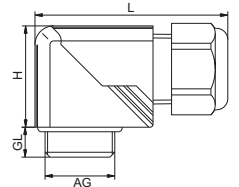

AG	Ø mm	GL mm	H mm	L mm	R mm	Ø mm	Number grey	Number black
M 16 x 1,5	4–8	8	23	45	5	19	1.313.1600.50	1.313.1601.50
M 16 x 1,5	2–6	8	23	45	5	19	1.313.1600.51	1.313.1601.51
M 20 x 1,5	6–12	9	30,5	57	7	24	1.313.2000.50	1.313.2001.50
M 20 x 1,5	5–9	9	30,5	57	7	24	1.313.2000.51	1.313.2001.51
M 25 x 1,5	13–18	11	40	73	10	33	1.313.2500.50	1.313.2501.50
M 25 x 1,5	9–16	11	40	73	10	33	1.313.2500.51	1.313.2501.51
M 32 x 1,5	18–25	11	51,5	91	14	42	1.313.3200.50	1.313.3201.50
M 32 x 1,5	13–20	11	51,5	91	14	42	1.313.3200.51	1.313.3201.51

HSK-W

NPT



// Glands not fitted with O-Rings
 // Other sealing materials e.g. silicone upon request
 // Other colors upon request

Material	Polyamide
Seal / O-Ring	Buna-N
Protection	IP 68
Operating Temperature	-40 °C – 100 °C (-40 °F – 212 °F)
Colors	grey (RAL 7035), black (RAL 9005)

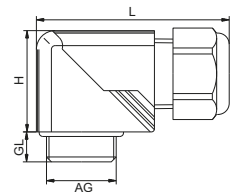

AG	Ø mm	GL mm	H mm	L mm	R mm	Ø mm	Number grey	Number black
NPT 3/8"	4–8	15	23	45	5	19	1.313.3800.70	1.313.3801.70
NPT 3/8"	2–6	15	23	45	5	19	1.313.3800.71	1.313.3801.71
NPT 1/2"	6–12	13	32,5	57	7	24	1.313.1200.70	1.313.1201.70
NPT 1/2"	5–9	13	32,5	57	7	24	1.313.1200.71	1.313.1201.71
NPT 1/2" (16)	10–14	13	31,5	59	8	27	1.313.1216.70	1.313.1217.70
NPT 1/2" (16)	7–12	13	31,5	59	8	27	1.313.1216.71	1.313.1217.71
NPT 3/4"	13–18	13	40	73	10	33	1.313.3400.70	1.313.3401.70
NPT 3/4"	9–16	13	40	73	10	33	1.313.3400.71	1.313.3401.71
NPT 1"	18–25	19	51,5	91	14	42	1.313.1000.70	1.313.1001.70
NPT 1"	13–20	19	51,5	91	14	42	1.313.1000.71	1.313.1001.71

HSK-W

PG



// Other sealing materials e.g. silicone upon request
 // Other colors upon request

Material	Polyamide
Seal / O-Ring	Buna-N
Protection	IP 68
Operating Temperature	-40 °C – 100 °C (-40 °F – 212 °F)
Colors	grey (RAL 7035), black (RAL 9005)

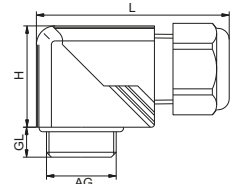

AG	\varnothing mm	GL mm	H mm	L mm	$\overset{R}{\curvearrowright}$ mm	\varnothing mm	Number grey	Number black
PG 9	4–8	8	23	45	5	19	1.313.0900.14	1.313.0901.14
PG 9	2–6	8	23	45	5	19	1.313.0900.15	1.313.0901.15
PG 11	5–10	8	27	50	6	22	1.313.1100.14	1.313.1101.14
PG 11	3–7	8	27	50	6	22	1.313.1100.15	1.313.1101.15
PG 13,5	6–12	9	30,5	57	7	24	1.313.1300.14	1.313.1301.14
PG 13,5	5–9	9	30,5	57	7	24	1.313.1300.15	1.313.1301.15
PG 16	10–14	10	32,5	59	8	27	1.313.1600.14	1.313.1601.14
PG 16	7–12	10	32,5	59	8	27	1.313.1600.15	1.313.1601.15
PG 21	13–18	11	40	73	10	33	1.313.2100.14	1.313.2101.14
PG 21	9–16	11	40	73	10	33	1.313.2100.15	1.313.2101.15
PG 29	18–25	11	51,5	91	14	42	1.313.2900.14	1.313.2901.14
PG 29	13–20	11	51,5	91	14	42	1.313.2900.15	1.313.2901.15

HSK-W rotating version

PG



// Other sealing materials e.g. silicone upon request
 // Other colors upon request

Material	Polyamide
Seal / O-Ring	Buna-N
Protection	IP 68
Operating Temperature	-40 °C – 100 °C (-40 °F – 212 °F)
Colors	grey (RAL 7035), black (RAL 9005)

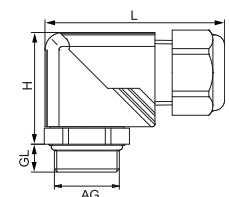

AG	\varnothing mm	GL mm	H mm	L mm	$\overset{R}{\curvearrowright}$ mm	\varnothing mm	Number grey	Number black
PG 9	4–8	8	28	45	5	19	1.317.0900.14	1.317.0901.14
PG 9	2–6	8	28	45	5	19	1.317.0900.15	1.317.0901.15
PG 11	5–10	8	32	50	6	22	1.317.1100.14	1.317.1101.14
PG 11	3–7	8	32	50	6	22	1.317.1100.15	1.317.1101.15
PG 13,5	6–12	9	35,5	57	7	24	1.317.1300.14	1.317.1301.14
PG 13,5	5–9	9	35,5	57	7	24	1.317.1300.15	1.317.1301.15
PG 16	10–14	10	38,5	59	8	27	1.317.1600.14	1.317.1601.14
PG 16	7–12	11	46	73	10	33	1.317.1600.15	1.317.1601.15
PG 21	13–18	11	46	73	10	33	1.317.2100.14	1.317.2101.14
PG 21	9–16	11	46	73	10	33	1.317.2100.15	1.317.2101.15

PLASTIC CABLE GLANDS

HSK-W-Flex

Metr., PG, NPT



Material	Polyamide
Seal / O-Ring	Buna-N
Protection	IP 68
Operating Temperature	-40 °C – 100 °C (-40 °F – 212 °F)
Colors	grey (RAL 7035), black (RAL 9005)



- // Other sealing materials e.g. silicone upon request
- // Other colors upon request

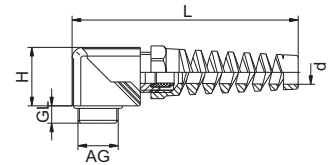

AG	Ø mm	d mm	GL mm	H mm	L mm	$\overset{R}{\curvearrowright}$ mm		Number grey	Number black
M 16 x 1,5	4–8	8,5	8	23	85	5	19	1.314.1600.50	1.314.1601.50
M 16 x 1,5	2–6	8,5	8	23	85	5	19	1.314.1600.51	1.314.1601.51
M 20 x 1,5	6–12	13	9	30,5	119	7	24	1.314.2000.50	1.314.2001.50
M 20 x 1,5	5–9	13	9	30,5	119	7	24	1.314.2000.51	1.314.2001.51
M 25 x 1,5	13–18	20	11	40	156	10	33	1.314.2500.50	1.314.2501.50
M 25 x 1,5	9–16	20	11	40	156	10	33	1.314.2500.51	1.314.2501.51
PG 9	4–8	8,5	8	23	85	5	19	1.314.0900.14	1.314.0901.14
PG 9	2–6	8,5	8	23	85	5	19	1.314.0900.15	1.314.0901.15
PG 11	5–10	10,5	8	27	103	6	22	1.314.1100.14	1.314.1101.14
PG 11	3–7	10,5	8	27	103	6	22	1.314.1100.15	1.314.1101.15
PG 13,5	6–12	13	9	30,5	119	7	24	1.314.1300.14	1.314.1301.14
PG 13,5	5–9	13	9	30,5	119	7	24	1.314.1300.15	1.314.1301.15
PG 16	10–14	15,5	10	32,5	130	8	27	1.314.1600.14	1.314.1601.14
PG 16	7–12	15,5	10	32,5	130	8	27	1.314.1600.15	1.314.1601.15
PG 21	13–18	20	11	40	156	10	33	1.314.2100.14	1.314.2101.14
PG 21	9–16	20	11	40	156	10	33	1.314.2100.15	1.314.2101.15
NPT 3/8"	4–8	8,5	15	23	85	5	19	1.314.3800.70	1.314.3801.70
NPT 3/8"	2–6	8,5	15	23	85	5	19	1.314.3800.71	1.314.3801.71
NPT 1/2"	6–12	13	13	30,5	119	7	24	1.314.1200.70	1.314.1201.70
NPT 1/2"	5–9	13	13	30,5	119	7	24	1.314.1200.71	1.314.1201.71
NPT 1/2" (16)	10–14	15,5	13	31,5	130	8	27	1.314.1216.70	1.314.1217.70
NPT 1/2" (16)	7–12	15,5	13	31,5	130	8	27	1.314.1216.71	1.314.1217.71
NPT 3/4"	13–18	20	13	40	156	10	33	1.314.3400.70	1.314.3401.70
NPT 3/4"	9–16	20	13	40	156	10	33	1.314.3400.71	1.314.3401.71

HSK-KE

PG



Material	Polyamide V0 according to UL 94
Seal	Buna-N
Protection	IP 68 – 10 bar / IP 69K (NEMA 6 – 150 PSIG) with additional O-Ring
Operating Temperature	-40 °C – 100 °C (-40 °F – 212 °F)
Colors	grey (RAL 7035), black (RAL 9005)



- // With additional pre-assembled O-Ring upon request
- // Suitable O-Ring on page 88
- // Other sealing materials and colors upon request

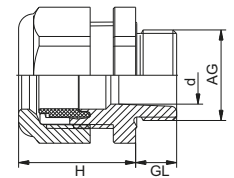

AG	Ø mm	d mm	GL mm	H mm	Ø mm	Number grey	Number black
PG 7	4–8	7	8	22	19	1.590.0700.14	1.590.0701.14
PG 7	2–6	7	8	22	19	1.590.0700.15	1.590.0701.15
PG 9	5–10	9	8	25	22	1.590.0900.14	1.590.0901.14
PG 9	3–7	9	8	25	22	1.590.0900.15	1.590.0901.15
PG 11	6–12	10,5	8	24	24	1.590.1100.14	1.590.1101.14
PG 11	5–9	10,5	8	24	24	1.590.1100.15	1.590.1101.15
PG 13,5	10–14	12,5	9	28	27	1.590.1300.14	1.590.1301.14
PG 13,5	7–12	12,5	9	28	27	1.590.1300.15	1.590.1301.15
PG 16	13–18	15	10	31	33	1.590.1600.14	1.590.1601.14
PG 16	9–16	15	10	31	33	1.590.1600.15	1.590.1601.15

HSK-KR PG



Material	Polyamide V0 according to UL 94
Seal	Buna-N
Protection	IP 68 – 10 bar / IP 69K (NEMA 6 – 150 PSIG) with additional O-Ring
Operating Temperature	-40 °C – 100 °C (-40 °F – 212 °F)
Colors	grey (RAL 7035), black (RAL 9005)



- // With additional pre-assembled O-Ring upon request
- // Suitable O-Ring on page 88
- // Other sealing materials and colors upon request

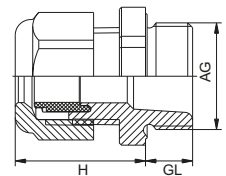

AG	∅k mm	GL mm	H mm	⌀ mm	Number grey	Number black
PG 9	3–6,5	8	21	19	1.591.0900.14	1.591.0901.14
PG 9	2–5	8	21	19	1.591.0900.15	1.591.0901.15
PG 11	4–8	8	22	22	1.591.1100.14	1.591.1101.14
PG 11	2–6	8	22	22	1.591.1100.15	1.591.1101.15
PG 13,5	5–10	9	25	24	1.591.1300.14	1.591.1301.14
PG 13,5	3–7	9	25	24	1.591.1300.15	1.591.1301.15
PG 16	6–12	10	27	27	1.591.1600.14	1.591.1601.14
PG 16	5–9	10	27	27	1.591.1600.15	1.591.1601.15
PG 21	10–14	11	28	33	1.591.2100.14	1.591.2101.14
PG 21	7–12	11	28	33	1.591.2100.15	1.591.2101.15

METAL CABLE GLANDS

Brass (nickel-plated) and stainless steel cable glands are very robust and generally suitable for industrial applications. The HSK series offers a huge range of solutions - for common, and also very unusual, applications. Uncompromising use of high-quality materials ensures the outstanding quality of HUMMEL products.

In this chapter, you will find:

- // HSK-M: Nickel-plated brass cable glands
- // HSK-INOX: Stainless steel cable glands in a range of variants
- // HSK-M-Multi: Glands for applications with several cables
- // HSK-M-Flaka: Variants for applications with flat cables
- // HSK-M-Flex: with bending protection
- // HSK-Mini: for threads smaller than M12
- // HSK-XL: Cable glands with threads from M63 to M110
- // HSK-MZ: Additional clamping for particularly high tension relief

In each case, HUMMEL offers different clamping areas, thread lengths, thread types and various sealing materials for different temperature ranges. The cable glands have all relevant approvals for international markets and a wide range of sectors.





Material	Nickel plated brass
Clamping insert	Polyamide / PVDF
Formdichtung	Buna-N / FKM
O-Ring	Buna-N / FKM
Protection	IP 68 – 10 bar / IP 69K (NEMA 6 – 150 PSIG)
Operating Temperature	-40 °C – 100 °C (-40 °F – 212 °F) (PA) -35 °C – 150 °C (-31 °F – 302 °F) (PVDF)



// Other sealing materials e.g. silicone upon request
 // Please see page 45 for size < M 12 and > M 63

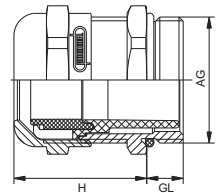

AG	∅ _k mm	GL mm	H mm	∅ _R mm	Number HSK-M -40 °C – 100 °C	Number HSK-M-PVDF -35 °C – 150 °C
M 12 x 1,5	3–6,5	6,5	19	14	1.609.1200.50	1.699.1200.50
M 12 x 1,5	2–5	6,5	19	14	1.609.1200.51	1.699.1200.51
M 16 x 1,5	4–8	6	21	17 / 19	1.609.1600.50	1.699.1600.50
M 16 x 1,5	2–6	6	21	17 / 19	1.609.1600.51	1.699.1600.51
M 16 x 1,5	5–10	6	22	20	1.609.1611.50	1.699.1611.50
M 20 x 1,5	6–12	6	23	22	1.609.2000.50	1.699.2000.50
M 20 x 1,5	5–9	6	23	22	1.609.2000.51	1.699.2000.51
M 20 x 1,5	10–14	6	24	24	1.609.2016.50	1.699.2016.50
M 25 x 1,5	13–18	7	26	30	1.609.2500.50	1.699.2500.50
M 25 x 1,5	9–16	7	26	30	1.609.2500.51	1.699.2500.51
M 32 x 1,5	18–25	8	31	40	1.609.3200.50	1.699.3200.50
M 32 x 1,5	13–20	8	31	40	1.609.3200.51	1.699.3200.51
M 32 x 1,5	15–21	8	33	36	1.609.3200.52	
M 40 x 1,5	22–32	8	37	50	1.609.4000.50	1.699.4000.50
M 40 x 1,5	20–26	8	37	50	1.609.4000.51	1.699.4000.51
M 40 x 1,5	19–27	8	33	46	1.609.4000.52	
M 50 x 1,5	32–38	9	37	57	1.609.5000.50	
M 50 x 1,5	25–31	9	37	57	1.609.5000.51	
M 63 x 1,5	37–44	10	38	64 / 68	1.609.6300.50	
M 63 x 1,5	29–35	10	38	64 / 68	1.609.6300.51	

HSK-M / HSK-M-PVDF

Metr.-elongated



Material	Nickel plated brass
Clamping insert	Polyamide / PVDF
Seal	Buna-N / FKM
O-Ring	Buna-N / FKM
Protection	IP 68 – 10 bar / IP 69K (NEMA 6 – 150 PSIG)
Operating Temperature	-40 °C – 100 °C (-40 °F – 212 °F) (PA) -35 °C – 150 °C (-31 °F – 302 °F) (PVDF)



// Other sealing materials e.g. silicone upon request
// Please see page 45 for size < M 12 and > M 63

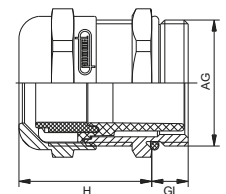

AG	Øk mm	GL mm	H mm	Ø mm	Number	
					HSK-M -40 °C – 100 °C	HSK-M-PVDF -35 °C – 150 °C
M 12 x 1,5	3–6,5	10	19	14	1.609.1200.30	1.699.1200.30
M 12 x 1,5	2–5	10	19	14	1.609.1200.31	1.699.1200.31
M 16 x 1,5	4–8	10	21	17 / 19	1.609.1600.30	1.699.1600.30
M 16 x 1,5	2–6	10	21	17 / 19	1.609.1600.31	1.699.1600.31
M 16 x 1,5	5–10	10	22	20	1.609.1611.30	1.699.1611.30
M 20 x 1,5	6–12	10	23	22	1.609.2000.30	1.699.2000.30
M 20 x 1,5	5–9	10	23	22	1.609.2000.31	1.699.2000.31
M 20 x 1,5	10–14	10	24	24	1.609.2016.30	1.699.2016.30
M 25 x 1,5	13–18	12	26	30	1.609.2500.30	1.699.2500.30
M 25 x 1,5	9–16	12	26	30	1.609.2500.31	1.699.2500.31
M 32 x 1,5	18–25	12	31	40	1.609.3200.30	1.699.3200.30
M 32 x 1,5	13–20	12	31	40	1.609.3200.31	1.699.3200.31
M 32 x 1,5	15–21	12	37	36	1.609.3200.32	
M 40 x 1,5	22–32	15	37	50	1.609.4000.30	1.699.4000.30
M 40 x 1,5	20–26	15	37	50	1.609.4000.31	1.699.4000.31
M 40 x 1,5	19–27	15	37	46	1.609.4000.32	
M 50 x 1,5	32–38	15	37	57	1.609.5000.30	
M 50 x 1,5	25–31	15	37	57	1.609.5000.31	
M 63 x 1,5	37–44	15	38	64 / 68	1.609.6300.30	
M 63 x 1,5	29–35	15	38	64 / 68	1.609.6300.31	



Material	Nickel plated brass
Clamping insert	Polyamide / PVDF
Seal	Buna-N / FKM
O-Ring	Buna-N / FKM
Protection	IP 68 – 10 bar / IP 69K (NEMA 6 – 150 PSIG)
Operating Temperature	-40 °C – 100 °C (-40 °F – 212 °F) (PA) -35 °C – 150 °C (-31 °F – 302 °F) (PVDF)



// Other sealing materials e.g. silicone upon request

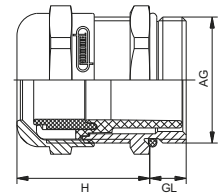

AG	Ø mm	GL mm	H mm	Ø mm	Number	
					HSK-M -40 °C – 100 °C	HSK-M-PVDF -35 °C – 150 °C
PG 7	3–6,5	5	19	14	1.609.0700.01	1.699.0700.01
PG 7	2–5	5	19	14	1.609.0700.15	1.699.0700.15
PG 9	4–8	6	21	17	1.609.0900.01	1.699.0900.01
PG 9	2–6	6	21	17	1.609.0900.15	1.699.0900.15
PG 11	5–10	6	22	20	1.609.1100.01	1.699.1100.01
PG 11	3–7	6	22	20	1.609.1100.15	1.699.1100.15
PG 13,5	6–12	6,5	24	22	1.609.1300.01	1.699.1300.01
PG 13,5	5–9	6,5	24	22	1.609.1300.15	1.699.1300.15
PG 16	10–14	6,5	23	24	1.609.1600.01	1.699.1600.01
PG 16	7–12	6,5	23	24	1.609.1600.15	1.699.1600.15
PG 21	13–18	7	24	30	1.609.2100.01	1.699.2100.01
PG 21	9–16	7	24	30	1.609.2100.15	1.699.2100.15
PG 29	18–25	8	29	40	1.609.2900.01	1.699.2900.01
PG 29	13–20	8	29	40	1.609.2900.15	1.699.2900.15
PG 36	22–32	8	35	50	1.609.3600.01	1.699.3600.01
PG 36	20–26	8	35	50	1.609.3600.15	1.699.3600.15
PG 42	32–38	9	37	57	1.609.4200.01	1.699.4200.01
PG 42	25–31	9	37	57	1.609.4200.15	1.699.4200.15
PG 48	37–44	10	38	64	1.609.4800.01	1.699.4800.01
PG 48	29–35	10	38	64	1.609.4800.15	1.699.4800.15

HSK-M / HSK-M-PVDF

PG-elongated



Material	Nickel plated brass
Clamping insert	Polyamide / PVDF
Seal	Buna-N / FKM
O-Ring	Buna-N / FKM
Protection	IP 68 – 10 bar / IP 69K (NEMA 6 – 150 PSIG)
Operating Temperature	-40 °C – 100 °C (-40 °F – 212 °F) (PA) -35 °C – 150 °C (-31 °F – 302 °F) (PVDF)



// Other sealing materials e.g. silicone upon request

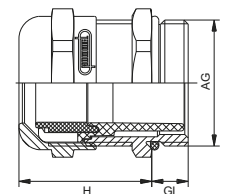

AG	Øk mm	GL mm	H mm	Ø mm	Number	
					HSK-M -40 °C – 100 °C	HSK-M-PVDF -35 °C – 150 °C
PG 7	3–6,5	10	19	14	1.609.0700.60	1.699.0700.60
PG 7	2–5	10	19	14	1.609.0700.61	1.699.0700.61
PG 9	4–8	10	21	17	1.609.0900.60	1.699.0900.60
PG 9	2–6	10	21	17	1.609.0900.61	1.699.0900.61
PG 11	5–10	10	22	20	1.609.1100.60	1.699.1100.60
PG 11	3–7	10	22	20	1.609.1100.61	1.699.1100.61
PG 13,5	6–12	10	24	22	1.609.1300.60	1.699.1300.60
PG 13,5	5–9	10	24	22	1.609.1300.61	1.699.1300.61
PG 16	10–14	10	23	24	1.609.1600.60	1.699.1600.60
PG 16	7–12	10	23	24	1.609.1600.61	1.699.1600.61
PG 21	13–18	12	24	30	1.609.2100.60	1.699.2100.60
PG 21	9–16	12	24	30	1.609.2100.61	1.699.2100.61
PG 29	18–25	12	29	40	1.609.2900.60	1.699.2900.60
PG 29	13–20	12	29	40	1.609.2900.61	1.699.2900.61
PG 36	22–32	15	35	50	1.609.3600.60	1.699.3600.60
PG 36	20–26	15	35	50	1.609.3600.61	1.699.3600.61
PG 42	32–38	15	37	57	1.609.4200.60	1.699.4200.60
PG 42	25–31	15	37	57	1.609.4200.61	1.699.4200.61
PG 48	37–44	15	38	64	1.609.4800.60	1.699.4800.60
PG 48	29–35	15	38	64	1.609.4800.61	1.699.4800.61

METAL CABLE GLANDS

HSK-M / HSK-M-PVDF NPT



Material	Nickel plated brass
Clamping insert	Polyamide / PVDF
Seal	Buna-N / FKM
O-Ring	Buna-N / FKM
Protection	IP 68 – 10 bar / IP 69K (NEMA 6 – 150 PSIG)
Operating Temperature	-40 °C – 100 °C (-40 °F – 212 °F) (PA) -35 °C – 150 °C (-31 °F – 302 °F) (PVDF)



// Other sealing materials e.g. silicone upon request

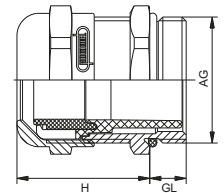

AG	∅ _k mm	GL mm	H mm	∅ _m mm	Number HSK-M -40 °C – 100 °C	Number HSK-M-PVDF -35 °C – 150 °C
NPT 3/8"	4–8	15	21	17 / 19	1.609.3800.70	1.699.3800.70
NPT 3/8"	2–6	15	21	17 / 19	1.609.3800.71	1.699.3800.71
NPT 1/2"	6–12	13	24	22 / 24	1.609.1200.70	1.699.1200.70
NPT 1/2"	5–9	13	24	22 / 24	1.609.1200.71	1.699.1200.71
NPT 3/4"	13–18	13	25	30	1.609.3400.70	1.699.3400.70
NPT 3/4"	9–16	13	25	30	1.609.3400.71	1.699.3400.71
NPT 1"	18–25	19	29	40	1.609.1000.70	
NPT 1"	13–20	19	29	40	1.609.1000.71	

HSK-M-Multi

Metr., PG, NPT



Material	Nickel plated brass
Clamping insert	Polyamide
Seal	Elastomer
O-Ring	Buna-N
Protection	IP 65 / IP 68 10 bar possible with ideal fit
Operating Temperature	-40 °C – 100 °C (-40 °F – 212 °F)



- // Other sealing materials e.g. silicone upon request
- // INOX upon request
- // Elongated threads upon request
- // Installation instructions see page 152
- // The inserts shown are samples, more seal inserts on page 86 or upon request

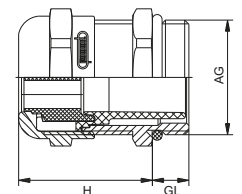

AG	GL mm	H mm	mm	Number of holes x d	Number	Number of holes x d	Number
M 12 x 1,5	6,5	19	14		1.697.1299.50		
M 16 x 1,5	6	21	17/19	4 x 1,4	1.697.1600.50	2 x 3	1.697.1601.50
M 20 x 1,5	6	23	22	6 x 3	1.697.2001.50	2 x 5	1.697.2003.50
M 25 x 1,5	7	26	30	4 x 6	1.697.2500.50	3 x 7	1.697.2501.50
M 32 x 1,5	8	31	40	6 x 6,5	1.697.3200.50	4 x 9	1.697.3201.50
M 40 x 1,5	8	37	50	7 x 9	1.697.4001.50	2 x 15	1.697.4003.50
M 50 x 1,5	9	37	57		1.697.5099.50		
M 63 x 1,5	10	38	64/68	6 x 12	1.697.6301.50	3 x 18	1.697.6302.50
PG 7	5	19	14		1.697.0799.01		
PG 9	6	21	17	4 x 1,4	1.697.0900.01	2 x 3	1.697.0901.01
PG 11	6	22	20	2 x 4	1.697.1102.01	3 x 3	1.697.1101.01
PG 13,5	6,5	24	22	3 x 4	1.697.1302.01	2 x 5	1.697.1303.01
PG 16	6,5	23	24	4 x 4	1.697.1602.01	6 x 4	1.697.1604.01
PG 16	6,5	23	24	3 x 5,6	1.697.1606.01	2 x 6	1.697.1605.01
PG 21	7	24	30	4 x 6	1.697.2100.01	3 x 7	1.697.2101.01
PG 29	8	29	40	6 x 6,5	1.697.2900.01	4 x 9	1.697.2901.01
PG 36	8	35	50	7 x 9	1.697.3601.01	2 x 15	1.697.3603.01
PG 42	9	37	57		1.697.4299.01		
PG 48	10	38	64	6 x 12	1.697.4801.01	3 x 18	1.697.4802.01
NPT 3/8"	15	21	17/19	4 x 1,4	1.697.3800.70	2 x 3	1.697.3801.70
NPT 1/2"	13	24	24	3 x 4	1.697.1202.70	2 x 5	1.697.1203.70
NPT 3/4"	13	25	30	4 x 6	1.697.3400.70	3 x 7	1.697.3401.70
NPT 1"	19	29	40	6 x 6,5	1.697.1000.70	4 x 9	1.697.1001.70



Material	Nickel plated brass
Clamping insert	Polyamide
Seal	Elastomer
O-Ring	Buna-N
Protection	IP 65 / IP 68 10 bar possible with ideal fit
Operating Temperature	-40 °C – 100 °C (-40 °F – 212 °F)



- // Other sealing materials e.g. silicone upon request
- // INOX upon request
- // Elongated threads upon request
- // Installation instructions see page 152
- // The inserts shown are samples, more inserts upon request

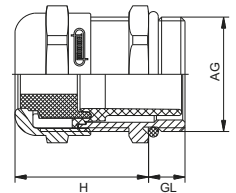

AG	GL mm	H mm	mm	w x h mm	Number	w x h mm	Number
M 20 x 1,5	6	24	24	11,5 x 5	1.688.2016.50	12 x 7	1.688.2017.50
M 20 x 1,5	6	24	24	14 x 6	1.688.2018.50		
M 25 x 1,5	7	26	30	14 x 6	1.688.2500.50	14 x 7	1.688.2501.50
M 32 x 1,5	8	31	40	22 x 8	1.688.3200.50		
M 40 x 1,5	8	37	50	28,5 x 10	1.688.4000.50	29 x 5,5	1.688.4001.50
M 40 x 1,5	8	37	50	30,5 x 12	1.688.4002.50	31 x 7,5	1.688.4003.50
M 50 x 1,5	9	37	57	33,5 x 11,5	1.688.5000.50		
M 63 x 1,5	10	38	64 / 68	38 x 12	1.688.6300.50		
PG 16	6,5	23	24	11,5 x 5	1.688.1600.01	12 x 7	1.688.1601.01
PG 16	6,5	23	24	14 x 6	1.688.1602.01		
PG 21	7	24	30	14 x 6	1.688.2100.01	14 x 7	1.688.2101.01
PG 29	8	29	40	22 x 8	1.688.2900.01		
PG 36	8	35	50	28,5 x 10	1.688.3600.01	29 x 5,5	1.688.3601.01
PG 36	8	35	50	30,5 x 12	1.688.3602.01	31 x 7,5	1.688.3603.01
PG 42	9	37	57	33,5 x 11,5	1.688.4200.01		
PG 48	10	38	64	38 x 12	1.688.4802.01		
NPT 3/4"	13	25	30	14 x 6	1.688.3400.70	14 x 7	1.688.3401.70
NPT 1"	19	29	40	22 x 8	1.688.1000.70		

HSK-M-Flex

Metr., Metr.-elongated



Material	Nickel plated brass
Steel spring	INOX 1.4310
Clamping insert	Polyamide
Seal	Buna-N
O-Ring	Buna-N
Protection	IP 68 – 10 bar / IP 69K (NEMA 6 – 150 PSIG)
Operating Temperature	-40 °C – 100 °C (-40 °F – 212 °F)



// Other sealing materials e.g. silicone upon request

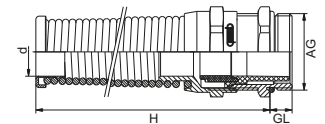

AG	Ø mm	d mm	H mm	 mm	GL mm	Number	GL mm	Number elongated
M 12 x 1,5	3–6,5	6,8	55	14	6,5	1.623.1200.50	10	1.623.1200.30
M 12 x 1,5	2–5	6,8	55	14	6,5	1.623.1200.51	10	1.623.1200.31
M 16 x 1,5	4–8	8,2	66	19	6	1.623.1600.50	10	1.623.1600.30
M 16 x 1,5	2–6	8,2	66	19	6	1.623.1600.51	10	1.623.1600.31
M 16 x 1,5	5–10	10,3	77	20	6	1.623.1611.50	10	1.623.1611.30
M 16 x 1,5	3–7	10,3	77	20	6	1.623.1611.51	10	1.623.1611.31
M 20 x 1,5	6–12	12,3	88	22	6	1.623.2000.50	10	1.623.2000.30
M 20 x 1,5	5–9	12,3	88	22	6	1.623.2000.51	10	1.623.2000.31
M 20 x 1,5	10–14	14,3	98	24	6	1.623.2016.50	10	1.623.2016.30
M 20 x 1,5	7–12	14,3	98	24	6	1.623.2016.51	10	1.623.2016.31
M 25 x 1,5	13–18	18,4	111	30	7	1.623.2500.50	12	1.623.2500.30
M 25 x 1,5	9–16	18,4	111	30	7	1.623.2500.51	12	1.623.2500.31

METAL CABLE GLANDS

HSK-M-Flex

PG, PG-elongated



Material	Nickel plated brass
Steel spring	INOX 1.4310
Clamping insert	Polyamide
Seal / O-Ring	Buna-N
Protection	IP 68 – 10 bar / IP 69K (NEMA 6 – 150 PSIG)
Operating Temperature	-40 °C – 100 °C (-40 °F – 212 °F)



// Other sealing materials e.g. silicone upon request

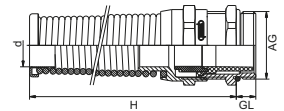

AG	Ø mm	d mm	H mm	 mm	GL mm	Number	GL mm	Number elongated
PG 7	3–6,5	6,8	55	14	5	1.623.0700.01	10	1.623.0700.60
PG 7	2–5	6,8	55	14	5	1.623.0700.15	10	1.623.0700.61
PG 9	4–8	8,2	66	17	6	1.623.0900.01	10	1.623.0900.60
PG 9	2–6	8,2	66	17	6	1.623.0900.15	10	1.623.0900.61
PG 11	5–10	10,3	77	20	6	1.623.1100.01	10	1.623.1100.60
PG 11	3–7	10,3	77	20	6	1.623.1100.15	10	1.623.1100.61
PG 13,5	6–12	12,3	88	22	6,5	1.623.1300.01	10	1.623.1300.60
PG 13,5	5–9	12,3	88	22	6,5	1.623.1300.15	10	1.623.1300.61
PG 16	10–14	14,3	98	24	6,5	1.623.1600.01	10	1.623.1600.60
PG 16	7–12	14,3	98	24	6,5	1.623.1600.15	10	1.623.1600.61
PG 21	13–18	18,4	111	30	7	1.623.2100.01	12	1.623.2100.60
PG 21	9–16	18,4	111	30	7	1.623.2100.15	12	1.623.2100.61

HSK-M-Flex

NPT



Material	Nickel plated brass
Steel spring	INOX 1.4310
Clamping insert	Polyamide
Seal / O-Ring	Buna-N
Protection	IP 68 – 10 bar / IP 69K (NEMA 6 – 150 PSIG)
Operating Temperature	-40 °C – 100 °C (-40 °F – 212 °F)



// Other sealing materials e.g. silicone upon request

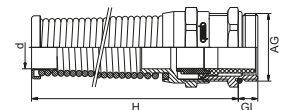

AG	\varnothing mm	d mm	GL mm	H mm	$\frac{H}{d}$ mm	Number
NPT 3/8"	4-8	8,2	15	66	17/19	1.623.3800.70
NPT 3/8"	2-6	8,2	15	66	17/19	1.623.3800.71
NPT 1/2"	6-12	12,3	13	88	22/24	1.623.1200.70
NPT 1/2"	5-9	12,3	13	88	22/24	1.623.1200.71
NPT 3/4"	13-18	18,4	13	111	33	1.623.3400.70
NPT 3/4"	9-16	18,4	13	111	33	1.623.3400.71

HSK-M-W Metr., PG



Material	Zinc die casting / Nickel plated brass
Clamping insert	Polyamide
Seal ring	Buna-N
O-Ring	Buna-N
Protection	IP 68
Operating Temperature	-40 °C – 100 °C (-40 °F – 212 °F)

// Other sealing materials e.g. silicone upon request

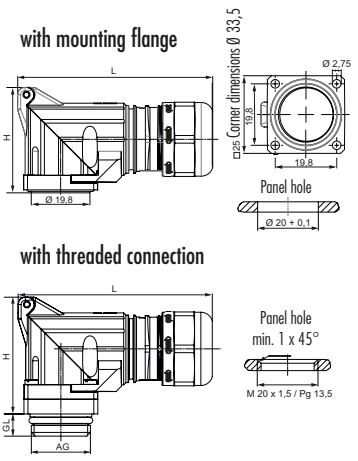

AG	\varnothing mm	GL mm	H mm	L mm	R mm		Number
with mounting flange							
	10–14		29	66	7	25	1.309.2000.50
	7–12		29	66	7	25	1.309.2000.51
with threaded connection							
M 20 x 1,5	10–14	6	37	66	7	25	1.309.2020.50
	7–12	6	37	66	7	25	1.309.2020.51
PG 13,5	10–14	6	37	66	7	25	1.309.2013.50
	7–12	6	37	66	7	25	1.309.2013.51

HSK-MZ / HSK-MZ-PVDF

Metr., Metr.-elongated



Material	Nickel plated brass
Clamping insert	Polyamide / PVDF
Seal	Buna-N / FKM
O-Ring	Buna-N / FKM
Protection	IP 68 – 10 bar / IP 69K (NEMA 6 – 150 PSIG) within the specified clamping range
Operating Temperature	-40 °C – 100 °C (-40 °F – 212 °F) (PA) -35 °C – 150 °C (-31 °F – 302 °F) (PVDF)

// Other sealing materials e.g. silicone upon request

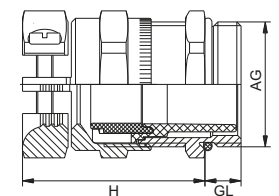

AG	Ø mm	H mm	mm	GL mm	Number		GL mm	Number	
					HSK-MZ -40 °C – 100 °C	HSK-MZ-PVDF -35 °C – 150 °C		HSK-MZ elongated -40 °C – 100 °C	
M 12 x 1,5	3–6,5	26	14	6,5	1.690.1200.50	1.669.1200.50	10	1.690.1200.30	
M 16 x 1,5	4–8	28	17/19	6	1.690.1600.50	1.669.1600.50	10	1.690.1600.30	
M 16 x 1,5	6–10	30	20	6	1.690.1611.50	1.669.1611.50	10	1.690.1611.30	
M 20 x 1,5	6–12	33	22	6	1.690.2000.50	1.669.2000.50	10	1.690.2000.30	
M 20 x 1,5	10–14	33	24	6	1.690.2016.50	1.669.2016.50	10	1.690.2016.30	
M 25 x 1,5	13–18	37	30	7	1.690.2500.50	1.669.2500.50	12	1.690.2500.30	
M 32 x 1,5	18–25	43	40	8	1.690.3200.50	1.669.3200.50	12	1.690.3200.30	
M 40 x 1,5	22–32	50	50	8	1.690.4000.50	1.669.4000.50	15	1.690.4000.30	
M 50 x 1,5	32–38	51	57	9	1.690.5000.50		15	1.690.5000.30	
M 50 x 1,5	25–31	51	57	9	1.690.5000.51		15	1.690.5000.31	
M 63 x 1,5	37–44	52	64/68	10	1.690.6300.50		15	1.690.6300.30	
M 63 x 1,5	29–35	52	64/68	10	1.690.6300.51		15	1.690.6300.31	

METAL CABLE GLANDS

HSK-MZ / HSK-MZ-PVDF

PG, PG-elongated, NPT



Material	Nickel plated brass
Clamping insert	Polyamide / PVDF
Seal	Buna-N / FKM
O-Ring	Buna-N / FKM
Protection	IP 68 – 10 bar / IP 69K (NEMA 6 – 150 PSIG)
Operating Temperature	-40 °C – 100 °C (-40 °F – 212 °F) (PA) -35 °C – 150 °C (-31 °F – 302 °F) (PVDF)

// Other sealing materials e.g. silicone upon request

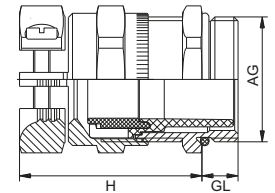

AG	∅ _k mm	H mm	 mm	GL mm	Number HSK-MZ -40 °C – 100 °C	Number HSK-MZ-PVDF -35 °C – 150 °C	GL mm	Number elongated
PG 7	3–6,5	26	14	5	1.690.0700.01	1.669.0700.01	10	1.690.0700.60
PG 9	4–8	28	17	6	1.690.0900.01	1.669.0900.01	10	1.690.0900.60
PG 11	6–10	30	20	6	1.690.1100.01	1.669.1100.01	10	1.690.1100.60
PG 13,5	6–12	33	22	6,5	1.690.1300.01	1.669.1300.01	10	1.690.1300.60
PG 16	10–14	33	24	6,5	1.690.1600.01	1.669.1600.01	10	1.690.1600.60
PG 21	13–18	37	30	7	1.690.2100.01	1.669.2100.01	12	1.690.2100.60
PG 29	18–25	43	40	8	1.690.2900.01	1.669.2900.01	12	1.690.2900.60
PG 36	22–36	50	50	8	1.690.3600.01	1.669.3600.01	15	1.690.3600.60
PG 42	32–38	51	57	9	1.690.4200.01	1.669.4200.01	15	1.690.4200.60
PG 42	25–31	51	57	9	1.690.4200.15	1.669.4200.15	15	1.690.4200.61
PG 48	37–44	52	64	10	1.690.4800.01	1.669.4800.01	15	1.690.4800.60
PG 48	29–35	51	64	10	1.690.4800.15	1.669.4800.15	15	1.690.4800.61
NPT 3/8"	4–8	28	17/19	15	1.690.3800.70	1.669.3800.70		
NPT 1/2"	7–12	33	22/24	13	1.690.1200.70	1.669.1200.70		
NPT 3/4"	13–18	37	30	13	1.690.3400.70	1.669.3400.70		
NPT 1"	18–25	43	40	19	1.690.1000.70			

HSK-Mini

Metr., PG



Material	Nickel plated brass / INOX 1.4305
Seal	Buna-N / TPE / FKM
O-Ring	Buna-N / FKM
Protection	IP 68
Operating Temperature	-20 °C – 100 °C (-4 °F – 212 °F) (Buna-N / TPE) -25 °C – 200 °C (-13 °F – 392 °F) (FKM)



HSK-Mini

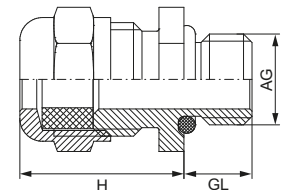

HSK-Mini EMC

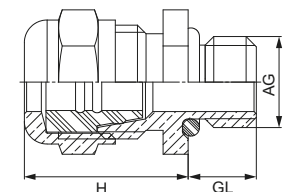

AG	\varnothing mm	GL mm	H mm	 mm	Number Buna-N/TPE	Number FKM
M 6 x 1	2-3,2	6	10	8	1.106.0601.50	1.106.0600.55
M 8 x 0,75	2-4,5	3,5	14,3	11	1.112.0801.01	
M 8 x 1,25	3-5	6	13	11	1.106.0801.50	1.106.0800.55
M 10 x 1,5	4-6	6	14	12	1.106.1001.50	1.106.1000.55
PG 7	2-4,5	3,5	14,3	11/15	1.112.0708.01	
HSK-Mini elongated						
M 8 x 1,25	3-5	10	13	11	1.106.0801.30	1.106.0800.35
M 10 x 1,5	4-6	10	14	12	1.106.1001.30	1.106.1000.35
HSK-Mini EMC						
M 8 x 1,25	3-5	6	13	11	1.119.0800.50	
M 10 x 1,5	4-6	6	14	12	1.119.1000.50	
HSK-Mini INOX						
M 8 x 1,25	3-5	6	13	11	1.129.0800.50	1.129.0800.55
M 10 x 1,5	4-6	6	14	12	1.129.1000.50	1.129.1000.55

METAL CABLE GLANDS

HSK-XL Metr.

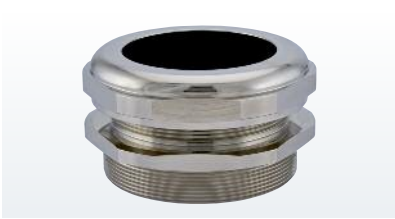

Material	Nickel plated brass
Seal	Buna-N
O-Ring	Buna-N
Protection	IP 68
Operating Temperature	-20 °C – 100 °C (-4 °F – 212 °F)

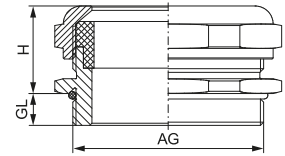

AG	Ø mm	GL mm	H mm	 mm	Number
M 63 x 1,5	48–55	10	42	75	1.106.6375.50
M 75 x 1,5	48–55	15	42	80	1.106.7500.50
M 75 x 1,5	53–60	15	42	85	1.106.7500.51
M 80 x 2	58–65	15	42	90	1.106.8000.50
M 90 x 2	63–70	15	42	100	1.106.9000.50
M 90 x 2	68–75	15	52	100	1.106.9000.51
M 100 x 2	78–85	20	52	110	1.106.1000.50
M 100 x 2	73–80	20	52	110	1.106.1000.51
M 110 x 2	83–90	20	52	120	1.106.1100.51

HSK-XL G

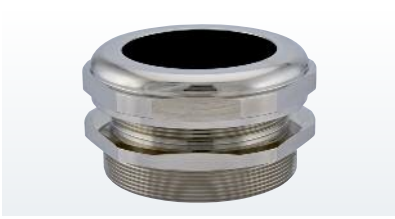

Material	Nickel plated brass
Seal	Buna-N
O-Ring	Buna-N
Protection	IP 68
Operating Temperature	-20 °C – 100 °C (-4 °F – 212 °F)

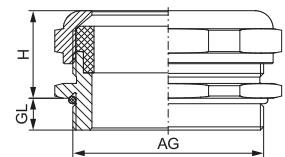

AG	Ø mm	GL mm	H mm	 mm	Number
G 2 1/2"	48–55	18	42	80	1.106.5200.01
G 2 1/2"	53–60	18	42	85	1.106.5201.01
G 3"	58–65	18	42	90/95	1.106.3000.01
G 3"	63–70	18	42	100	1.106.3001.01
G 4"	68–75	22	52	100/120	1.106.4000.01
G 4"	73–80	22	52	110/120	1.106.4001.01
G 4"	78–85	22	52	110/120	1.106.4002.01
G 4"	83–90	22	52	120	1.106.4003.01

HSK-INOX / HSK-INOX-PVDF

Metr.



Material	INOX 1.4305 / 1.4404
Clamping insert	Polyamide / PVDF
Seal	Buna-N / FKM
O-Ring	Buna-N / FKM
Protection	IP 68 – 10 bar / IP 69K (NEMA 6 – 150 PSIG)
Operating Temperature	-40 °C – 100 °C (-40 °F – 212 °F) (PA) -35 °C – 150 °C (-31 °F – 302 °F) (PVDF)



// Other sealing materials e.g. silicone upon request

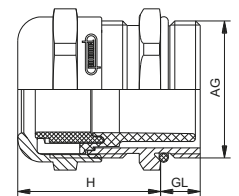

AG	Øk mm	GL mm	H mm	Ø mm	Number		Number	
					HSK-INOX 1.4305	HSK-INOX-PVDF 1.4305	HSK-INOX 1.4404	HSK-INOX-PVDF 1.4404
					-40 °C – 100 °C	-35 °C – 150 °C	-40 °C – 100 °C	-35 °C – 150 °C
M 12 x 1,5	3–6,5	6,5	19	14	1.695.1200.50	1.696.1200.50	1.675.1200.50	1.676.1200.50
M 12 x 1,5	2–5	6,5	19	14	1.695.1200.51	1.696.1200.51	1.675.1200.51	1.676.1200.51
M 16 x 1,5	5–10	6	22	22	1.695.1600.50	1.696.1600.50	1.675.1600.50	1.676.1600.50
M 16 x 1,5	3–7	6	22	22	1.695.1600.51	1.696.1600.51	1.675.1600.51	1.676.1600.51
M 20 x 1,5	10–14	6	23	24	1.695.2000.50	1.696.2000.50	1.675.2000.50	1.676.2000.50
M 20 x 1,5	7–12	6	23	24	1.695.2000.51	1.696.2000.51	1.675.2000.51	1.676.2000.51
M 25 x 1,5	13–18	7	24	30	1.695.2500.50	1.696.2500.50	1.675.2500.50	1.676.2500.50
M 25 x 1,5	9–16	7	24	30	1.695.2500.51	1.696.2500.51	1.675.2500.51	1.676.2500.51
M 32 x 1,5	18–25	8	31	41	1.695.3200.50	1.696.3200.50	1.675.3200.50	1.676.3200.50
M 32 x 1,5	13–20	8	31	41	1.695.3200.51	1.696.3200.51	1.675.3200.51	1.676.3200.51
M 40 x 1,5	22–32	8	37	50	1.695.4000.50	1.696.4000.50	1.675.4000.50	1.676.4000.50
M 40 x 1,5	20–26	8	37	50	1.695.4000.51	1.696.4000.51	1.675.4000.51	1.676.4000.51
M 50 x 1,5	32–38	9	37	60	1.695.5000.50		1.675.5000.50	
M 50 x 1,5	25–31	9	37	60	1.695.5000.51		1.675.5000.51	
M 63 x 1,5	37–44	10	38	64/68	1.695.6300.50		1.675.6300.50	
M 63 x 1,5	29–35	10	38	64/68	1.695.6300.51		1.675.6300.51	



Material	INOX 1.4305 / 1.4404
Clamping insert	Polyamide / PVDF
Seal	Buna-N / FKM
O-Ring	Buna-N / FKM
Protection	IP 68 – 10 bar / IP 69K (NEMA 6 – 150 PSIG)
Operating Temperature	-40 °C – 100 °C (-40 °F – 212 °F) (PA) -35 °C – 150 °C (-31 °F – 302 °F) (PVDF)



// Other sealing materials e.g. silicone upon request

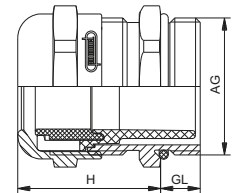

AG	Øk mm	GL mm	H mm	Ø mm	Number		Number	
					HSK-INOX 1.4305	HSK-INOX-PVDF 1.4305	HSK-INOX 1.4404	HSK-INOX-PVDF 1.4404
					-40 °C – 100 °C	-35 °C – 150 °C	-40 °C – 100 °C	-35 °C – 150 °C
PG 7	3–6,5	5	19	14	1.695.0700.01	1.696.0700.01	1.675.0700.01	1.676.0700.01
PG 7	2–5	5	19	14	1.695.0700.15	1.696.0700.15	1.675.0700.15	1.676.0700.15
PG 9	4–8	6	21	17	1.695.0900.01	1.696.0900.01	1.675.0900.01	1.676.0900.01
PG 9	2–6	6	21	17	1.695.0900.15	1.696.0900.15	1.675.0900.15	1.676.0900.15
PG 11	5–10	6	22	22	1.695.1100.01	1.696.1100.01	1.675.1100.01	1.676.1100.01
PG 11	3–7	6	22	22	1.695.1100.15	1.696.1100.15	1.675.1100.15	1.676.1100.15
PG 13,5	6–12	6,5	24	22	1.695.1300.01	1.696.1300.01	1.675.1300.01	1.676.1300.01
PG 13,5	5–9	6,5	24	22	1.695.1300.15	1.696.1300.15	1.675.1300.15	1.676.1300.15
PG 16	10–14	6,5	23	24	1.695.1600.01	1.696.1600.01	1.675.1600.01	1.676.1600.01
PG 16	7–12	6,5	23	24	1.695.1600.15	1.696.1600.15	1.675.1600.15	1.676.1600.15
PG 21	13–18	7	24	30	1.695.2100.01	1.696.2100.01	1.675.2100.01	1.676.2100.01
PG 21	9–16	7	24	30	1.695.2100.15	1.696.2100.15	1.675.2100.15	1.676.2100.15
PG 29	18–25	8	29	41	1.695.2900.01	1.696.2900.01	1.675.2900.01	1.676.2900.01
PG 29	13–20	8	29	41	1.695.2900.15	1.696.2900.15	1.675.2900.15	1.676.2900.15
PG 36	22–32	8	35	50	1.695.3600.01	1.696.3600.01	1.675.3600.01	1.676.3600.01
PG 36	20–26	8	35	50	1.695.3600.15	1.696.3600.15	1.675.3600.15	1.676.3600.15
PG 42	32–38	9	37	57	1.695.4200.01	1.696.4200.01	1.675.4200.01	1.676.4200.01
PG 42	25–31	9	37	57	1.695.4200.15	1.696.4200.15	1.675.4200.15	1.676.4200.15
PG 48	37–44	10	38	64	1.695.4800.01	1.696.4800.01	1.675.4800.01	1.676.4800.01
PG 48	29–35	10	38	64	1.695.4800.15	1.696.4800.15	1.675.4800.15	1.676.4800.15

HSK-INOX / HSK-INOX-PVDF

NPT



Material	INOX 1.4305 / 1.4404
Clamping insert	Polyamide / PVDF
Seal	Buna-N / FKM
O-Ring	Buna-N / FKM
Protection	IP 68 – 10 bar / IP 69K (NEMA 6 – 150 PSIG)
Operating Temperature	-40 °C – 100 °C (-40 °F – 212 °F) (PA) -35 °C – 150 °C (-31 °F – 302 °F) (PVDF)



- // PVDF type upon request
- // Other sealing materials e.g. silicone upon request

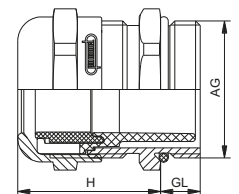

AG	Ø mm	GL mm	H mm	Ø mm	Number HSK-INOX 1.4305	Number HSK-INOX 1.4404
NPT 3/8"	4–8	15	21	17 / 19	1.695.3800.70	1.675.3800.70
NPT 3/8"	2–6	15	21	17 / 19	1.695.3800.71	1.675.3800.71
NPT 1/2"	6–12	13	24	22 / 24	1.695.1200.70	1.675.1200.70
NPT 1/2"	5–9	13	24	22 / 24	1.695.1200.71	1.675.1200.71
NPT 3/4"	13–18	13	25	30	1.695.3400.70	1.675.3400.70
NPT 3/4"	9–16	13	25	30	1.695.3400.71	1.675.3400.71
NPT 1"	18–25	19	29	41	1.695.1000.70	1.675.1000.70
NPT 1"	13–20	19	29	41	1.695.1000.71	1.675.1000.71

METAL CABLE GLANDS

WADI-A-FKM Metr.



Material	Nickel plated brass
Seal ring	FKM
O-Ring	FKM
Protection	IP 68 (NEMA 6)
Operating Temperature	-25 °C – 200 °C (-13 °F – 392 °F)

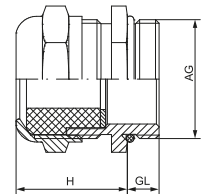

AG	∅ mm	GL mm	H mm	⌀ mm	Number
M 12 x 1,5	4–6	5	18	14	1.106.1200.58
M 16 x 1,5	7–9	5	19	18	1.106.1600.58
M 20 x 1,5	10–13	6	21	22	1.106.2000.58
M 25 x 1,5	15–18	7	23	28	1.106.2500.58
M 32 x 1,5	20–24	8	26	35	1.106.3200.58
M 40 x 1,5	27–32	8	27	45	1.106.4000.58
M 50 x 1,5	35–40	10	28	55	1.106.5000.58
M 63 x 1,5	45–52	10	36	68	1.106.6300.58

WADI-A-FKM PG



Material	Nickel plated brass
Seal ring	FKM
O-Ring	FKM
Protection	IP 68 (NEMA 6)
Operating Temperature	-25 °C – 200 °C (-13 °F – 392 °F)

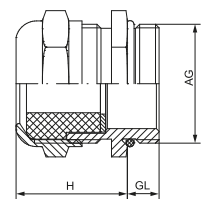

AG	∅ mm	GL mm	H mm	⌀ mm	Number
PG 7	5–7	6	16	14	1.106.0700.80
PG 9	6–8	6	17	18	1.106.0900.80
PG 9	7–10	6	17	18	1.106.0901.80
PG 11	6–8	6	20	18	1.106.1100.80
PG 11	7–10	6	20	18	1.106.1101.80
PG 11	8–12	6	20	18	1.106.1102.80
PG 13,5	11–15	6	21	24	1.106.1300.80
PG 16	11–15	6	21	24	1.106.1600.80
PG 21	15–20,5	7,5	22,5	32	1.106.2100.80
PG 29	20–27	8	24	40	1.106.2900.80
PG 36	30–35	8	29	50	1.106.3600.80
PG 42	40–45	10	31	60	1.106.4200.80
PG 48	42–49	11	33	64	1.106.4800.80

EMC CABLE GLANDS

Protecting power units and electronic components from electromagnetic influences is becoming increasingly important. Cable management and connection solutions are of particularly high importance in this regard. Only a secure, long-lasting, 360° shield connection guarantees lasting protection for technical equipment.

In this chapter, you will find:

- // HSK-M-EMC: The standard version with very good shield effectiveness
- // HSK-M-EMC-D: Simple, quick fitting with maximum EMC protection
- // PVDF variants for applications in the particularly high temperature range
- // Flex variants with integrated bending protection
- // Glands with additional tension relief (HSK-M-EMC-MZ)
- // Stainless steel variants with outstanding shielding effectiveness

In each case, HUMMEL offers different clamping areas, thread lengths, thread types and various sealing materials for different temperature ranges. The cable glands have all relevant approvals for international markets and a wide range of sectors.

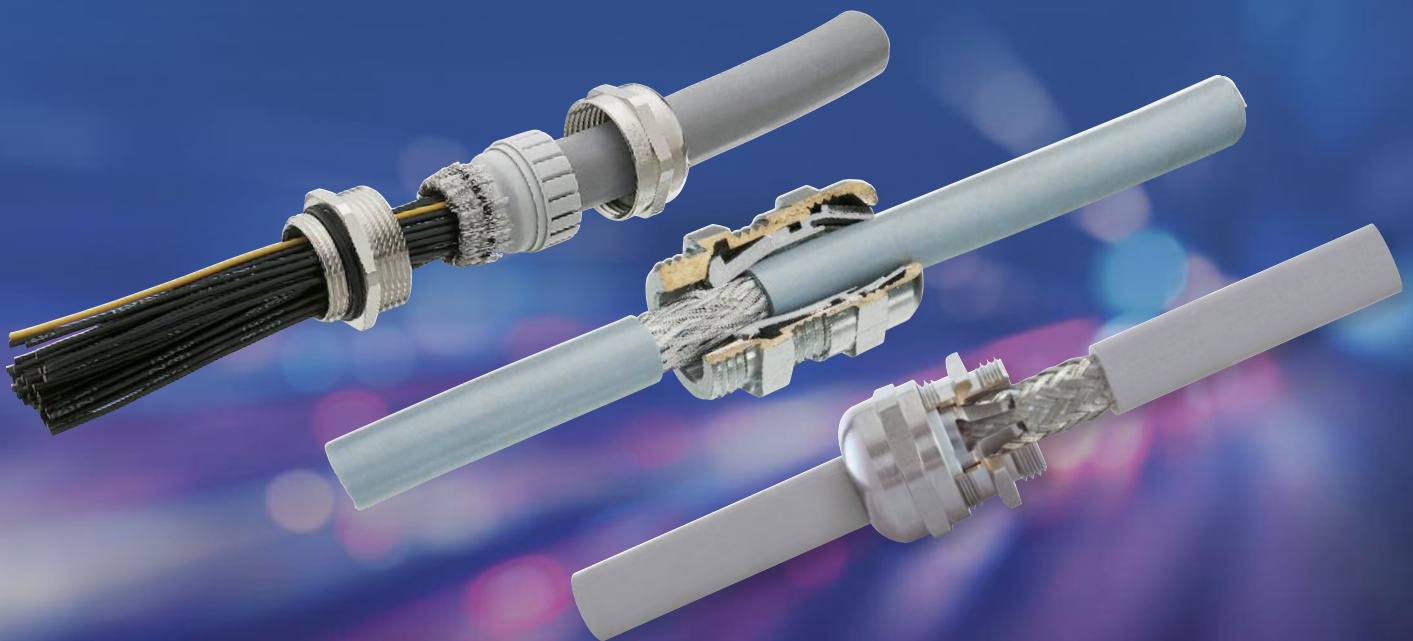

EMC CABLE GLANDS

HSK-M-EMC-D Metr., Metr.-elongated



Material	Nickel plated brass
Clamping insert	Metallized polyamide
Seal	Buna-N
O-Ring	Buna-N
Protection	IP 68 – 10 bar / IP 69K (NEMA 6 – 150 PSIG)
Operating Temperature	-40 °C – 100 °C (-40 °F – 212 °F)

// Other sealing materials e.g. silicone upon request

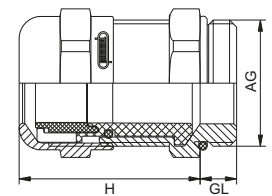

AG	∅ _k mm	H mm	∅ _R mm	GL mm	Number	GL mm	Number elongated
M 12 x 1,5	3–6,5	25	14	6,5	1.631.1200.50	10	1.631.1200.30
M 16 x 1,5	4–8	29	17/19	6	1.631.1609.50	10	1.631.1609.30
M 16 x 1,5	5–10	32	20	6	1.631.1600.50	10	1.631.1600.30
M 20 x 1,5	6–12	32,5	22	6	1.631.2013.50	10	1.631.2013.30
M 20 x 1,5	10–14	33	24	6	1.631.2000.50	10	1.631.2000.30
M 25 x 1,5	13–18	39	30	7	1.631.2500.50	12	1.631.2500.30
M 32 x 1,5	18–25	45	40	8	1.631.3200.50	12	1.631.3200.30
M 40 x 1,5	24–32	51	50	8	1.631.4000.50	15	1.631.4000.30
M 50 x 1,5	32–38	57,5	57	9	1.631.5000.50	15	1.631.5000.30
M 63 x 1,5	37–44	52	64/68	10	1.631.6300.50	15	1.631.6300.30



HSK-M-EMC-D

PG, NPT



Material	Nickel plated brass
Clamping insert	Metallized polyamide
Seal	Buna-N
O-Ring	Buna-N
Protection	IP 68 – 10 bar / IP 69K (NEMA 6 – 150 PSIG)
Operating Temperature	-40 °C – 100 °C (-40 °F – 212 °F)

// Other sealing materials e.g. silicone upon request

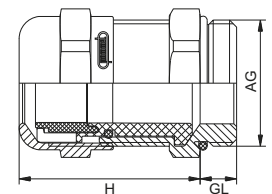

AG	∅k mm	GL mm	H mm	⌀ mm	Number
PG 7	3–6,5	5	24	14	1.631.0700.01
PG 9	4–8	6	28	17	1.631.0900.01
PG 11	5–10	6	29	20	1.631.1100.01
PG 13,5	6–12	6,5	31	22	1.631.1300.01
PG 16	10–14	6,5	32	24	1.631.1600.01
PG 21	13–18	7	38	30	1.631.2100.01
PG 29	18–25	8	43	40	1.631.2900.01
PG 36	24–32	8	48	50	1.631.3600.01
PG 42	32–38	9	45	57	1.631.4200.01
PG 48	37–44	10	46	64	1.631.4800.01
NPT 3/8"	4–8	15	29	17/19	1.631.3800.70
NPT 1/2"	6–12	13	32,5	22/24	1.631.1200.70
NPT 3/4"	13–18	13	39	30	1.631.3400.70



Material	Nickel plated brass
Clamping insert	Polyamide
Seal	Buna-N
O-Ring	Buna-N
Protection	IP 68 – 5 bar
Operating Temperature	-40 °C – 100 °C (-40 °F – 212 °F)

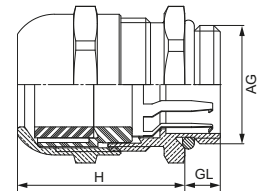

AG	\varnothing mm	GL mm	H mm	 mm	Number
M 12 x 1,5	3–6,5	6	19,4	14	1.607.1200.50
M 16 x 1,5	4,5–10	6	24,4	19	1.607.1600.50
M 20 x 1,5	6–12	6	25,4	22	1.607.2013.50
M 20 x 1,5	7,5–14	6	28,3	24	1.607.2000.50
M 25 x 1,5	9–17	7	29,3	29	1.607.2500.50
M 32 x 1,5	11–21	8	37,7	34	1.607.3200.50
M 40 x 1,5	19–28	8	40,7	44	1.607.4000.50
M 50 x 1,5	27–35	9	50,7	55	1.607.5000.50
M 63 x 1,5	34–48	10	55,7	68	1.607.6300.50

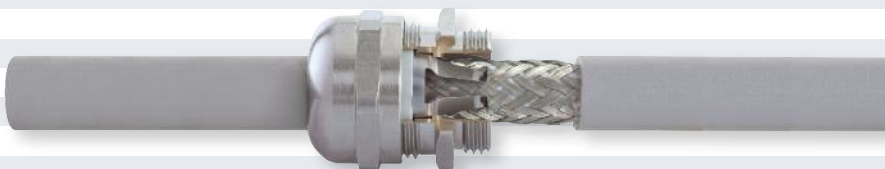

HSK-M-EMC / HSK-M-PVDF-EMC

Metr., PG-elongated



Material	Nickel plated brass
Clamping insert	Polyamide / PVDF
Seal	Buna-N / FKM
O-Ring	Buna-N / FKM
Protection	IP 68 – 10 bar / IP 69K (NEMA 6 – 150 PSIG)
Dauergebrauchstemperatur	-40 °C – 100 °C (-40 °F – 212 °F) (PA) -35 °C – 150 °C (-31 °F – 302 °F) (PVDF)



// Other sealing materials e.g. silicone upon request
 // Please see page 45 for HSK-Mini EMC M 8 and M10

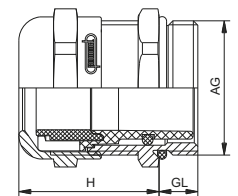

AG	∅k mm	H mm	mm	GL mm	Number HSK-M-EMC -40 °C – 100 °C	Number HSK-M-PVDF-EMC -35 °C – 150 °C	GL mm	Number HSK-M-EMC elongated -40 °C – 100 °C
M 12 x 1,5	3–6,5	19	14	6,5	1.691.1200.50	1.698.1200.50	10	1.691.1200.30
M 12 x 1,5	2–5	19	14	6,5	1.691.1200.51	1.698.1200.51	10	1.691.1200.31
M 16 x 1,5	5–10	22	20	6	1.691.1600.50	1.698.1611.50	10	1.691.1600.30
M 16 x 1,5	3–7	22	20	6	1.691.1600.51	1.698.1611.51	10	1.691.1600.31
M 20 x 1,5	10–14	24	24	6	1.691.2000.50	1.698.2000.50	10	1.691.2000.30
M 20 x 1,5	7–12	24	24	6	1.691.2000.51	1.698.2000.51	10	1.691.2000.31
M 25 x 1,5	13–18	26	30	7	1.691.2500.50	1.698.2500.50	12	1.691.2500.30
M 25 x 1,5	9–16	26	30	7	1.691.2500.51	1.698.2500.51	12	1.691.2500.31
M 32 x 1,5	18–25	31	40	8	1.691.3200.50		12	1.691.3200.30
M 32 x 1,5	13–20	31	40	8	1.691.3200.51		12	1.691.3200.31
M 32 x 1,5	15–21	33	36	8	1.691.3200.52		12	1.691.3200.32
M 40 x 1,5	22–32	37	50	8	1.691.4000.50		15	1.691.4000.30
M 40 x 1,5	20–26	37	50	8	1.691.4000.51		15	1.691.4000.31
M 40 x 1,5	19–27	33	46	8	1.691.4000.52		15	1.691.4000.32
M 50 x 1,5	32–38	37	57	9	1.691.5000.50		15	1.691.5000.30
M 50 x 1,5	25–31	37	57	9	1.691.5000.51		15	1.691.5000.31
M 63 x 1,5	37–44	38	64/68	10	1.691.6300.50		15	1.691.6300.30
M 63 x 1,5	29–35	38	64/68	10	1.691.6300.51		15	1.691.6300.31

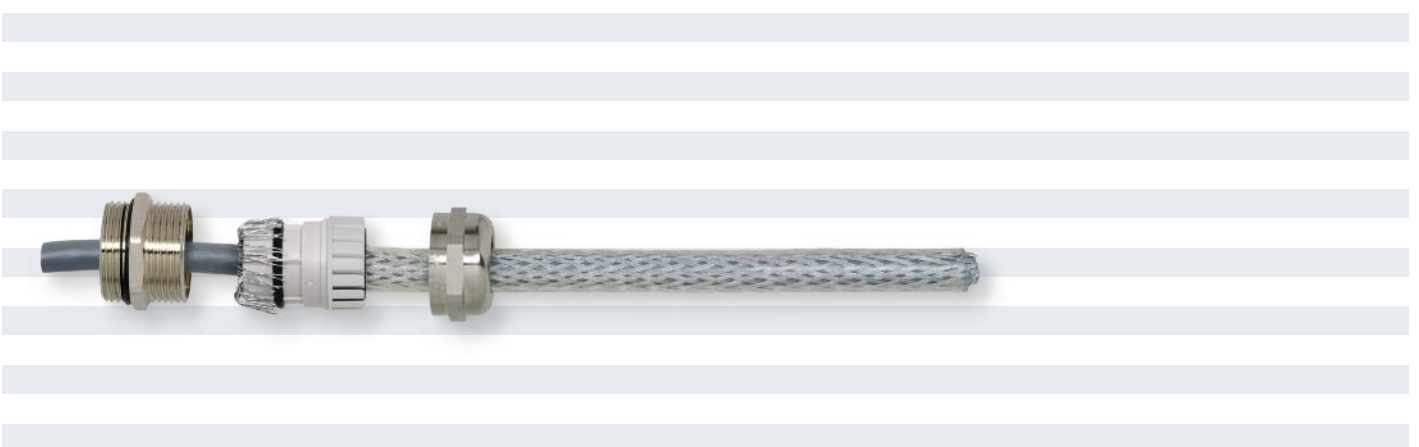

EMC CABLE GLANDS

HSK-M-EMC / HSK-M-PVDF-EMC

PG, PG-elongated, NPT



Material	Nickel plated brass
Clamping insert	Polyamide / PVDF
Seal	Buna-N / FKM
O-Ring	Buna-N / FKM
Protection	IP 68 – 10 bar / IP 69K (NEMA 6 – 150 PSIG)
Operating Temperature	-40 °C – 100 °C (-40 °F – 212 °F) (PA) -35 °C – 150 °C (-31 °F – 302 °F) (PVDF)

// Other sealing materials e.g. silicone upon request

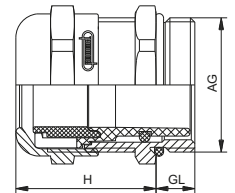

AG	\varnothing mm	H mm	\varnothing mm	GL mm	Number HSK-M-EMC -40 °C – 100 °C	Number HSK-M-PVDF-EMC -35 °C – 150 °C	GL mm	Number HSK-M-EMC elongated -40 °C – 100 °C
PG 7	3–6,5	19	14	5	1.691.0700.01	1.698.0700.01	10	1.691.0700.60
PG 7	2–5	19	14	5	1.691.0700.15	1.698.0700.15	10	1.691.0700.61
PG 9	4–8	21	17	6	1.691.0900.01	1.698.0900.01	10	1.691.0900.60
PG 9	2–6	21	17	6	1.691.0900.15	1.698.0900.15	10	1.691.0900.61
PG 11	5–10	22	20	6	1.691.1100.01	1.698.1100.01	10	1.691.1100.60
PG 11	3–7	22	20	6	1.691.1100.15	1.698.1100.15	10	1.691.1100.61
PG 13,5	6–12	24	22	6,5	1.691.1300.01	1.698.1300.01	10	1.691.1300.60
PG 13,5	5–9	24	22	6,5	1.691.1300.15	1.698.1300.15	10	1.691.1300.61
PG 16	10–14	23	24	6,5	1.691.1600.01	1.698.1600.01	10	1.691.1600.60
PG 16	7–12	23	24	6,5	1.691.1600.15	1.698.1600.15	10	1.691.1600.61
PG 21	13–18	24	30	7	1.691.2100.01	1.698.2100.01	12	1.691.2100.60
PG 21	9–16	24	30	7	1.691.2100.15	1.698.2100.15	12	1.691.2100.61
PG 29	18–25	29	40	8	1.691.2900.01	1.698.2900.01	12	1.691.2900.60
PG 29	13–20	29	40	8	1.691.2900.15	1.698.2900.15	12	1.691.2900.61
PG 36	22–32	35	50	8	1.691.3600.01	1.698.3600.01	15	1.691.3600.60
PG 36	20–26	35	50	8	1.691.3600.15	1.698.3600.15	15	1.691.3600.61
PG 42	32–38	37	57	9	1.691.4200.01		15	1.691.4200.60
PG 42	25–31	37	57	9	1.691.4200.15		15	1.691.4200.61
PG 48	37–44	38	64	10	1.691.4800.01		15	1.691.4800.60
PG 48	29–35	38	64	10	1.691.4800.15		15	1.691.4800.61
NPT 3/8"	4–8	21	17/19	15	1.691.3800.70			
NPT 3/8"	2–6	21	17/19	15	1.691.3800.71			
NPT 1/2"	6–12	24	22/24	13	1.691.1200.70			
NPT 1/2"	5–9	24	22/24	13	1.691.1200.71			
NPT 3/4"	13–18	25	30	13	1.691.3400.70			
NPT 3/4"	9–16	25	30	13	1.691.3400.71			

HSK-M-Flex-EMC

Metr., Metr.-elongated



Material	Nickel plated brass
Steel spring	INOX 1.4310
Clamping insert	Polyamide
Seal	Buna-N
O-Ring	Buna-N
Protection	IP 68 – 10 bar / IP 69K (NEMA 6 – 150 PSIG)
Operating Temperature	-40 °C – 100 °C (-40 °F – 212 °F)



// Other sealing materials e.g. silicone upon request

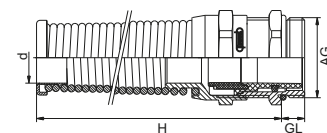

AG	Ø mm	d mm	H mm	H mm	GL mm	Number	GL mm	Number elongated
M 12 x 1,5	3–6,5	6,8	55	14	6,5	1.624.1200.50	10	1.624.1200.30
M 12 x 1,5	2–5	6,8	55	14	6,5	1.624.1200.51	10	1.624.1200.31
M 16 x 1,5	5–10	10,3	77	20	6	1.624.1600.50	10	1.624.1600.30
M 16 x 1,5	3–7	10,3	77	20	6	1.624.1600.51	10	1.624.1600.31
M 20 x 1,5	10–14	14,3	98	24	6	1.624.2000.50	10	1.624.2000.30
M 20 x 1,5	7–12	14,3	98	24	6	1.624.2000.51	10	1.624.2000.31
M 25 x 1,5	13–18	18,4	111	30	7	1.624.2500.50	12	1.624.2500.30
M 25 x 1,5	9–16	18,4	111	30	7	1.624.2500.51	12	1.624.2500.31

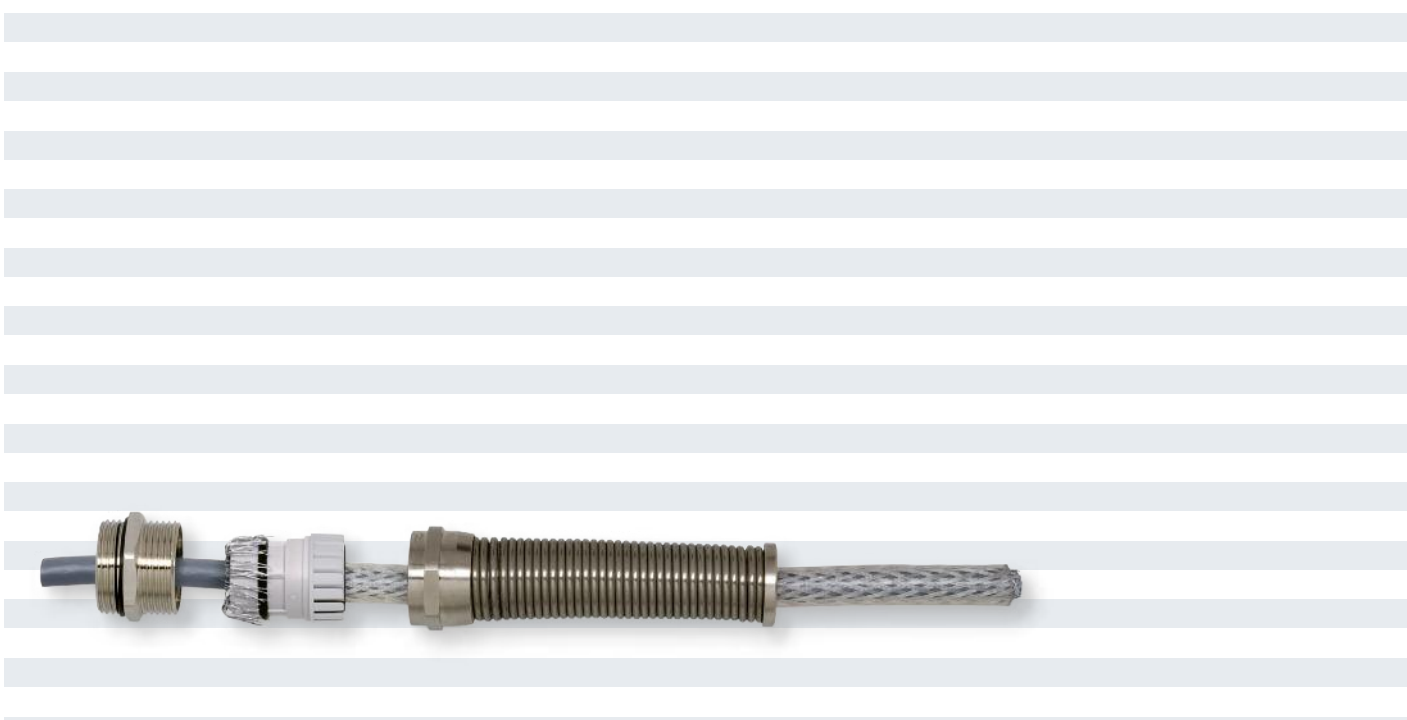



Material	Nickel plated brass
Steel spring	INOX 1.4310
Clamping insert	Polyamide
Seal	Buna-N
O-Ring	Buna-N
Protection	IP 68 – 10 bar / IP 69K (NEMA 6 – 150 PSIG)
Operating Temperature	-40 °C – 100 °C (-40 °F – 212 °F)



// Other sealing materials e.g. silicone upon request

// Also available in PVDF, -35 °C – 150 °C

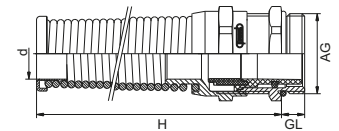

AG	∅k mm	d mm	H mm	⌀ mm	GL mm	Number	GL mm	Number elongated
PG 7	3–6,5	6,8	55	14	5	1.624.0700.01	10	1.624.0700.60
PG 7	2–5	6,8	55	14	5	1.624.0700.15	10	1.624.0700.61
PG 9	4–8	8,2	66	17	6	1.624.0900.01	10	1.624.0900.60
PG 9	2–6	8,2	66	17	6	1.624.0900.15	10	1.624.0900.61
PG 11	5–10	10,3	77	20	6	1.624.1100.01	10	1.624.1100.60
PG 11	3–7	10,3	77	20	6	1.624.1100.15	10	1.624.1100.61
PG 13,5	6–12	12,3	88	22	6,5	1.624.1300.01	10	1.624.1300.60
PG 13,5	5–9	12,3	88	22	6,5	1.624.1300.15	10	1.624.1300.61
PG 16	10–14	14,3	98	24	6,5	1.624.1600.01	10	1.624.1600.60
PG 16	7–12	14,3	98	24	6,5	1.624.1600.15	10	1.624.1600.61
PG 21	13–18	18,4	111	30	7	1.624.2100.01	12	1.624.2100.60
PG 21	9–16	18,4	111	30	7	1.624.2100.15	12	1.624.2100.61
NPT 3/8"	4–8	8,2	66	17/19	15	1.624.3800.70		
NPT 3/8" NPT	2–6	8,2	66	17/19	15	1.624.3800.71		
NPT 1/2" NPT	6–12	12,3	88	22/24	13	1.624.1200.70		
NPT 1/2" NPT	5–9	12,3	88	22/24	13	1.624.1200.71		
NPT 3/4" NPT	13–18	18,4	111	30	13	1.624.3400.70		
NPT 3/4" NPT	9–16	18,4	111	30	13	1.624.3400.71		

HSK-MZ-EMC

Metr., Metr.-elongated, PG, PG-elongated, NPT



Material	Nickel plated brass
Clamping insert	Polyamide
Seal	Buna-N
O-Ring	Buna-N
Protection	IP 68 – 10 bar / IP 69K (NEMA 6 – 150 PSIG)
Operating Temperature	-40 °C – 100 °C (-40 °F – 212 °F)

// Other sealing materials e.g. silicone upon request
 // Also available in PVDF, -35 °C – 150 °C *

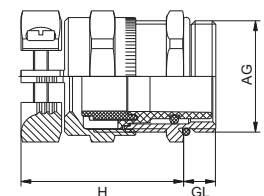

AG	∅k mm	H mm	R mm	GL mm	Number	GL mm	Number elongated
M 12 x 1,5	3–6,5	26	14	6,5	1.692.1200.50	10	1.692.1200.30
M 16 x 1,5	6–10	29	20	6	1.692.1600.50	10	1.692.1600.30
M 20 x 1,5	10–14	32	24	6	1.692.2000.50	10	1.692.2000.30
M 25 x 1,5	13–18	35	30	7	1.692.2500.50	12	1.692.2500.30
M 32 x 1,5	18–25	41	40	8	1.692.3200.50	12	1.692.3200.30
M 40 x 1,5	22–32	48	50	8	1.692.4000.50	15	1.692.4000.30
M 50 x 1,5	32–38	51	57	9	1.692.5000.50	15	1.692.5000.30
M 50 x 1,5	25–31	51	57	9	1.692.5000.51	15	1.692.5000.31
M 63 x 1,5	37–44	52	64/68	10	1.692.6300.50	15	1.692.6300.30
M 63 x 1,5	29–35	52	64/68	10	1.692.6300.51	15	1.692.6300.31
PG 7*	3–6,5	26	14	5	1.692.0700.01	10	1.692.0700.60
PG 9*	4–8	28	17	6	1.692.0900.01	10	1.692.0900.60
PG 11*	6–10	29	20	6	1.692.1100.01	10	1.692.1100.60
PG 13,5*	6–12	33	22	6,5	1.692.1300.01	10	1.692.1300.60
PG 16*	10–14	32	24	6,5	1.692.1600.01	10	1.692.1600.60
PG 21*	13–18	35	30	7	1.692.2100.01	12	1.692.2100.60
PG 29*	18–25	41	40	8	1.692.2900.01	12	1.692.2900.60
PG 36*	22–32	48	50	8	1.692.3600.01	15	1.692.3600.60
PG 42*	32–38	51	57	9	1.692.4200.01	15	1.692.4200.60
PG 42*	25–31	51	57	9	1.692.4200.15	15	1.692.4200.61
PG 48*	37–44	51	64	10	1.692.4800.01	15	1.692.4800.60
PG 48*	29–35	51	64	10	1.692.4800.15	15	1.692.4800.61
NPT 3/8"	4–8	28	17/19	15	1.692.3800.70		
NPT 1/2"	6–12	29	22/24	13	1.692.1200.70		
NPT 3/4"	13–18	35	30	13	1.692.3400.70		





Material	INOX 1.4305
Clamping insert	Polyamide
Seal	Buna-N
O-Ring	Buna-N
Protection	IP 68 – 10 bar / IP 69K (NEMA 6 – 150 PSIG)
Operating Temperature	-40 °C – 100 °C (-40 °F – 212 °F)



// INOX 1.4404 upon request

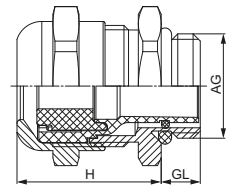

AG	∅k mm	GL mm	H mm	⌀ mm	Number
M 12 x 1,5	3–6,5	6,5	19	14	1.693.1200.50
M 12 x 1,5	2–5	6,5	19	14	1.693.1200.51
M 16 x 1,5	5–10	6	21	20	1.693.1600.50
M 16 x 1,5	3–7	6	21	20	1.693.1600.51
M 20 x 1,5	10–14	6	23	24	1.693.2000.50
M 20 x 1,5	7–12	6	23	24	1.693.2000.51
M 25 x 1,5	13–18	7	26	30	1.693.2500.50
M 25 x 1,5	9–16	7	26	30	1.693.2500.51
M 32 x 1,5	18–25	8	31	40	1.693.3200.50
M 32 x 1,5	13–20	8	31	40	1.693.3200.51
M 40 x 1,5	22–32	8	37	50	1.693.4000.50
M 40 x 1,5	20–26	8	37	50	1.693.4000.51
PG 7	3–6,5	5	19	14	1.693.0700.01
PG 7	2–5	5	19	14	1.693.0700.15
PG 9	4–8	6	21	17	1.693.0900.01
PG 9	2–6	6	21	17	1.693.0900.15
PG 11	5–10	6	22	22	1.693.1100.01
PG 11	3–7	6	22	22	1.693.1100.15
PG 13,5	6–12	6,5	24	22	1.693.1300.01
PG 13,5	5–9	6,5	24	22	1.693.1300.15
PG 16	10–14	6,5	23	24	1.693.1600.01
PG 16	7–12	6,5	23	24	1.693.1600.15
PG 21	13–18	7	24	30	1.693.2100.01
PG 21	9–16	7	24	30	1.693.2100.15
PG 29	18–25	8	29	41	1.693.2900.01
PG 29	13–20	8	29	41	1.693.2900.15
PG 36	22–32	8	35	50	1.693.3600.01
PG 36	20–26	8	35	50	1.693.3600.15

CABLE GLANDS FOR SPECIAL APPLICATIONS

With the VariaPro series, HUMMEL focusses on very special applications and the particular requirements of selected sectors. The VariaPro cable glands have been designed for very special sector requirements in each case. Their specific strengths with regard to temperature, fire protection or hygiene are certified which means they can be used without restriction in these extreme applications.

In this chapter, you will find:

- // VariaPro Rail: The cable gland with railway approval EN 45545-3
- // VariaPro Temp: Suitable for particularly low, and extremely high temperatures
- // VariaPro FKM: The acid-resistant cable gland for the process industry
- // HSK-INOX-HD: Developed for areas with a high level of hygienic requirements
- // HSK-INOX-HD-Pro: The HD cable gland with EHEDG certification

In each case, HUMMEL offers different clamping areas, thread lengths, thread types and various sealing materials for different temperature ranges. The cable glands have all relevant approvals for international markets and a wide range of sectors.



CABLE GLANDS FOR SPECIAL APPLICATIONS

VariaPro Rail Metr.



Material	Nickel plated brass
Seal	EPDM
O-Ring	EPDM
Protection	IP 68 – 10 bar within the specified clamping range
Operating Temperature	-40 °C – 100 °C (-40 °F – 212 °F)



- // DIN EN 45545-2 and DIN EN 45545-3
- // Fire resistance E30
- // Large clamping range due to reducer
- // No twisting of inserts and cables

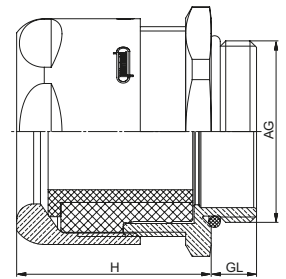

AG	\varnothing mm	GL	H mm	\varnothing mm Dome Nut	\varnothing mm Body	Number
M 20 x 1,5	7,0–14,0	6	27	22	24	1.750.2000.50*
M 20 x 1,5	10,0–14,0	6	27	22	24	1.750.2000.51
M 25 x 1,5	11,0–18,0	7	29	27	30	1.750.2500.50*
M 25 x 1,5	14,5–18,0	7	29	27	30	1.750.2500.51
M 32 x 1,5	16,0–25,0	8	34	36	40	1.750.3200.50*
M 32 x 1,5	20,5–25,0	8	34	36	40	1.750.3200.51
M 40 x 1,5	21,0–32,0	8	40	46	50	1.750.4000.50*
M 40 x 1,5	26,5–32,0	8	40	46	50	1.750.4000.51

* Versions with removable reducers

CABLE GLANDS FOR SPECIAL APPLICATIONS

VariaPro Temp

Metr.



Material	Nickel plated brass
Seal	VMQ (Silicone)
O-Ring	VMQ (Silicone)
Protection	IP 68 – 10 bar within the specified clamping range
Operating Temperature	-60 °C – 200 °C (-76 °F – 392 °F)

RoHS

EMC

- // Suitable for applications under extreme temperature conditions
- // Integrated option for EMC connection
- // Large clamping range due to reducer
- // No twisting of inserts and cables

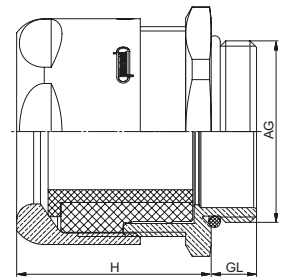

AG	\varnothing mm	GL	H mm	 mm Dome Nut	 mm Body	Number
M 20 x 1,5	7,0 – 14,0	6	27	22	24	1.751.2000.50*
M 20 x 1,5	10,0 – 14,0	6	27	22	24	1.751.2000.51
M 25 x 1,5	11,0 – 18,0	7	29	27	30	1.751.2500.50*
M 25 x 1,5	14,5 – 18,0	7	29	27	30	1.751.2500.51
M 32 x 1,5	16,0 – 25,0	8	34	36	40	1.751.3200.50*
M 32 x 1,5	20,5 – 25,0	8	34	36	40	1.751.3200.51
M 40 x 1,5	21,0 – 32,0	8	40	46	50	1.751.4000.50*
M 40 x 1,5	26,5 – 32,0	8	40	46	50	1.751.4000.51

* Versions with removable reducers

CABLE GLANDS FOR SPECIAL APPLICATIONS

VariaPro FKM

Metr.



RoHS

EMC



Material	Nickel plated brass
Seal	FKM
O-Ring	FKM
Protection	IP 68 – 10 bar within the specified clamping range
Operating Temperature	-20 °C – 180 °C (-4 °F – 356 °F)

- // High resistance against the influence of acids and chemicals
- // Integrated option for EMC connection
- // Large clamping range due to reducer
- // No twisting of inserts and cables

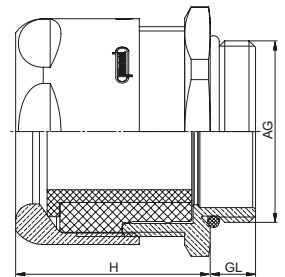

AG	\varnothing mm	GL	H mm	\varnothing mm Dome Nut	\varnothing mm Body	Number
M 20 x 1,5	7,0–14,0	6	27	22	24	1.752.2000.50*
M 20 x 1,5	10,0–14,0	6	27	22	24	1.752.2000.51
M 25 x 1,5	11,0–18,0	7	29	27	30	1.752.2500.50*
M 25 x 1,5	14,5–18,0	7	29	27	30	1.752.2500.51
M 32 x 1,5	16,0–25,0	8	34	36	40	1.752.3200.50*
M 32 x 1,5	20,5–25,0	8	34	36	40	1.752.3200.51
M 40 x 1,5	21,0–32,0	8	40	46	50	1.752.4000.50*
M 40 x 1,5	26,5–32,0	8	40	46	50	1.752.4000.51

* Versions with removable reducers

CABLE GLANDS FOR SPECIAL APPLICATIONS

HSK-INOX-HD

Metr.

EMC



Material HD-enclosure	INOX 1.4404 / AISI 316 L
Sealing HD-enclosure	VMQ (Silicone), blue (similar RAL 5017)
Protection	IP 68
Operating Temperature	-40 °C – 120 °C (-40 °F – 248 °F)

- // EMC integrated
- // VDMA Riboflavintest fulfilled and passed
- // Durability and cleanability tested and passed with compounds from ECOLAB

ideal for foam-cleaning

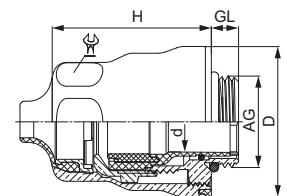

AG	∅k mm	d mm	GL mm	H mm	D mm	Wrench mm	Number
M 12 x 1,5	3,5–6,5	5,8	6	30	21	14	1.740.1202.50
M 16 x 1,5	5–10	9,3	6	34	27	18/20	1.740.1602.50
M 20 x 1,5	10–14	13,2	6	34,5	33	24	1.740.2002.50
M 25 x 1,5	13–18	17,3	7	41,5	40	27/30	1.740.2502.50

CABLE GLANDS FOR SPECIAL APPLICATIONS

HSK-INOX-HD-Pro

Metr.

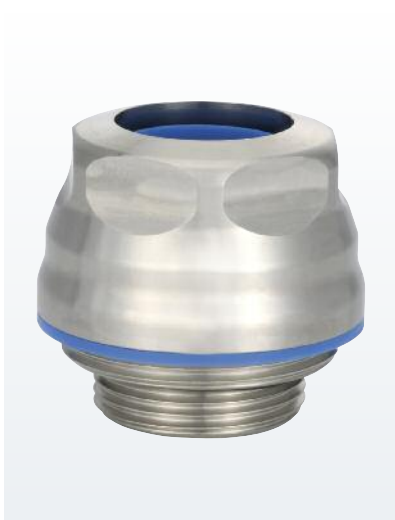

Material HD-enclosure	INOX 1.4404 / AISI 316 L
Sealing HD-enclosure	VMQ (Silicone), blue (similar RAL 5017)
Protection	IP 66, IP 68 to 10 bar, IP 69K
Operating Temperature	-40 °C – 120 °C (-40 °F – 248 °F)



- // EMC connection integrated
- // VDMA Riboflavin cleaning test passed
- // EHEDG 01 cleaning test passed
- // EHEDG certificate EL class I AUX approved

ideal for high-pressure cleaning

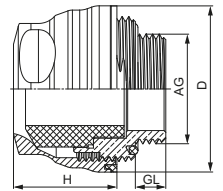

AG	∅k mm	GL mm	H mm	D mm	⌀ mm	Number
M 12 x 1,5	5–6,5	6	19	21	14	1.740.1203.50
M 16 x 1,5	7,5–10	6	20	27	19 / 21	1.740.1603.50
M 16 x 1,5	6–7,5	6	20	27	19 / 21	1.740.1603.51
M 20 x 1,5	11–13,5	6	22,5	33	24 / 27	1.740.2003.50
M 20 x 1,5	9–12	6	22,5	33	24 / 27	1.740.2003.51
M 20 x 1,5	11–13,5	6	20	28	21 / 24	1.740.2003.54
M 25 x 1,5	15–18	7	23,5	38	30	1.740.2503.50
M 25 x 1,5	14–16	7	23,5	38	30	1.740.2503.52
M 32 x 1,5	21–25	8	26,5	45	36	1.740.3203.50
M 32 x 1,5	18–21	8	26,5	45	36	1.740.3203.51

DIN CABLE GLANDS

These cable glands have been designed to meet the requirements of very special norms and standards. This means they have a different construction and function compared to the premium cable glands in the HSK series. DIN cable glands offer very special clamping areas and feature a very low construction height.

In this chapter, you will find:

- // DIN 46320: Plastic and brass cable glands
- // Z (DIN 46320): Cable glands with extra high tension relief
- // SE (DIN 46320): Cable glands with EMC connection
- // ZSE (DIN 46320): Cable glands with extra high tension relief and EMC connection

In each case, HUMMEL offers different clamping areas, thread types and various sealing materials for different temperature ranges. The cable glands have the necessary approvals and certificates.



DIN CABLE GLANDS

DIN 46320-A-FS with seal ring No. 6

PG



// Metric thread upon request
 // Please see page 89 for suitable thread seal ring

Material	Polyamide
Seal ring	Buna-N
Schutzart	IP 54, with thread seal ring IP 65
Operating Temperature	-20 °C – 80 °C (-4 °F – 176 °F)
Colors	grey (RAL 7035)

RoHS

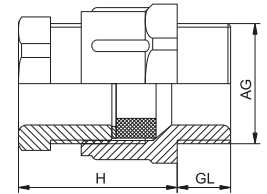

AG	\varnothing mm	GL mm	H mm	 mm	Number
PG 7	3,5–6	8	20	15 / 13	1.202.0700.11
PG 9	4,5–7	8	21	19 / 16	1.202.0900.11
PG 11	6–9	8	22	22 / 19	1.202.1100.11
PG 13,5	9–12	9	26	24 / 21	1.202.1300.11
PG 16	11–14	10	28	27 / 23	1.202.1600.11
PG 21	14–18	11	32	33 / 30	1.202.2100.11
PG 29	18–25	11	35	42 / 40	1.202.2900.11
PG 36	25–32	13	39	53 / 50	1.202.3600.11
PG 42	30–38	13	44	60 / 55	1.202.4200.11
PG 48	34–42	14	44	65 / 60	1.202.4800.11

DIN 46320-A-FS with multiperforated seal ring No. 7

PG



// Metric thread upon request
 // Please see page 89 for suitable thread seal ring

Material	Polyamide
Seal ring	Buna-N (multiperforated)
Schutzart	IP 54, with thread seal ring IP 65
Operating Temperature	-20 °C – 80 °C (-4 °F – 176 °F)
Colors	grey (RAL 7035)

RoHS

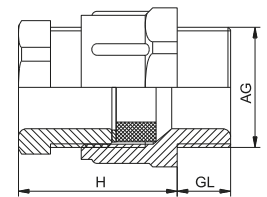

AG	\varnothing mm	GL mm	H mm	 mm	Number
PG 9	4–10	8	21	19 / 16	1.202.0901.11
PG 11	6,5–12	8	22	22 / 19	1.202.1101.11
PG 13,5	6,5–13,5	9	26	24 / 21	1.202.1301.11
PG 16	6,5–16	10	28	27 / 23	1.202.1601.11
PG 21	9–20	11	32	33 / 30	1.202.2101.11
PG 29	17–28	11	35	42 / 40	1.202.2901.11
PG 36	23–34	13	39	53 / 50	1.202.3601.11
PG 42	29–40	13	44	60 / 55	1.202.4201.11
PG 48	35–46	14	44	65 / 60	1.202.4801.11

DIN 46320-C4-Ms with seal ring No. 6

PG



- // Metric thread upon request
- // Please see page 89 for suitable thread seal ring
- // This cable gland is available with additional strain relief (see page 70 / 71) and EMC attenuation (see page 72)

Material	Nickel plated brass
Seal ring	Buna-N
Protection	IP 54, with thread seal ring IP 65
Operating Temperature	-20 °C – 80 °C (-4 °F – 176 °F)

RoHS

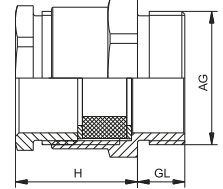

AG	∅ _k mm	GL mm	H mm	⌀ mm	Number
PG 7	6–8	5	15	14 / 13	1.101.0703.01
PG 9	8–10	6	15	17 / 15	1.101.0903.01
PG 11	10–12	6	17	20 / 18	1.101.1103.01
PG 13,5	12–14	6,5	20	22 / 20	1.101.1303.01
PG 16	14–16	6,5	22	24 / 22	1.101.1603.01
PG 21	17–19	7	24	30 / 28	1.101.2103.01
PG 29	26–28	8	26	40 / 37	1.101.2903.01
PG 36	33–35	9	30	50 / 47	1.101.3603.01
PG 42	39–41	10	34	57 / 54	1.101.4203.01
PG 48	45–47	10	37	64 / 60	1.101.4803.01

DIN 46320-C4-Ms with multiperforated seal ring No. 7

PG



- // Metric thread upon request
- // Please see page 89 for suitable thread seal ring
- // This cable gland is available with additional strain relief (see page 70 / 71) and EMC attenuation (see page 72)

Material	Nickel plated brass
Seal ring	Buna-N (multiperforated)
Protection	IP 54, with thread seal ring IP 65
Operating Temperature	-20 °C – 80 °C (-4 °F – 176 °F)

RoHS

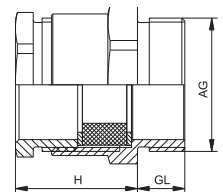

AG	∅ _k mm	GL mm	H mm	⌀ mm	Number
PG 9	4–10	6	15	17 / 15	1.101.0901.01
PG 11	6,5–12	6	17	20 / 18	1.101.1101.01
PG 13,5	6,5–13,5	6,5	20	22 / 20	1.101.1301.01
PG 16	6,5–16	6,5	22	24 / 22	1.101.1601.01
PG 21	9–20	7	24	30 / 28	1.101.2101.01
PG 29	17–28	8	26	40 / 37	1.101.2901.01
PG 36	23–34	9	30	50 / 47	1.101.3601.01
PG 42	29–40	10	34	57 / 54	1.101.4201.01
PG 48	35–46	10	37	64 / 60	1.101.4801.01

DIN CABLE GLANDS

Z (DIN 46320-C4-Ms with seal ring No. 6 with additional strain relief)

Metr.



// Please see page 89 for suitable thread seal ring

Material	Nickel plated brass
Seal ring	Buna-N
Protection	IP 54, with thread seal ring IP 65
Operating Temperature	-20 °C – 80 °C (-4 °F – 176 °F)

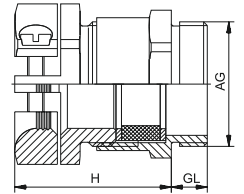

AG	\varnothing mm	GL mm	H mm	 mm	Number
M 12 x 1,5	6–8	5	22	14/16	1.105.1200.51
M 16 x 1,5	8–10	5	25	18/19	1.105.1600.51
M 20 x 1,5	10–12	6	26	22/22	1.105.2000.51
M 20 x 1,5	12–14	6	27,5	22/24	1.105.2013.51
M 20 x 1,5	13–15	6	28,5	24/26	1.105.2016.51
M 25 x 1,5	17–19	6	33	30/33	1.105.2500.51
M 32 x 1,5	26–27	6	36	39/42	1.105.3200.51
M 40 x 1,5	33–35	7	41	50/52	1.105.4000.51
M 50 x 1,5	39–41	8	45	57/59	1.105.5000.51
M 63 x 1,5	43–45	9	48	66/64	1.105.6300.51

Z (DIN 46320-C4-Ms with multiperforated seal ring No. 7 with additional strain relief)

Metr.



// Please see page 89 for suitable thread seal ring

Material	Nickel plated brass
Seal ring	Buna-N (multiperforated)
Protection	IP 54, with thread seal ring IP 65
Operating Temperature	-20 °C – 80 °C (-4 °F – 176 °F)

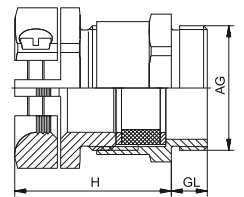

AG	\varnothing mm	GL mm	H mm	 mm	Number
M 16 x 1,5	6,5–10	5	25	18/19	1.105.1600.52
M 20 x 1,5	7,5–12	6	26	22/22	1.105.2000.52
M 20 x 1,5	8,5–13,5	6	27,5	22/24	1.105.2013.52
M 20 x 1,5	10,5–15	6	28,5	24/26	1.105.2016.52
M 25 x 1,5	13–20	6	33	30/33	1.105.2500.52
M 32 x 1,5	19–28	6	36	39/42	1.105.3200.52
M 40 x 1,5	24–34	7	41	50/52	1.105.4000.52
M 50 x 1,5	34–40	8	45	57/59	1.105.5000.52
M 63 x 1,5	39–46	9	48	66/64	1.105.6300.52

Z (DIN 46320-C4-Ms with seal ring No. 6 with additional strain relief)

PG

// Please see page 89 for suitable thread seal ring
 // Please see page 72 for the EMC version of this gland

Material	Nickel plated brass
Seal ring	Buna-N
Protection	IP 54, with thread seal ring IP 65
Operating Temperature	-20 °C – 80 °C (-4 °F – 176 °F)

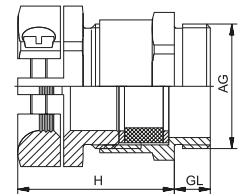
RoHS

AG	$\sqrt{\text{Ø}}$ mm	GL mm	H mm	$\sqrt{\text{Ø}}$ mm	Number Buna-N -20 °C – 80 °C
PG 7	6–8	5	22	14/16	1.105.0703.01
PG 9	8–10	6	25	17/19	1.105.0903.01
PG 11	10–12	6	26	20/22	1.105.1103.01
PG 13,5	12–14	6,5	27,5	22/24	1.105.1303.01
PG 16	14–16	6,5	28,5	24/26	1.105.1603.01
PG 21	17–19	7	33	30/33	1.105.2103.01
PG 29	26–28	8	36	40/42	1.105.2903.01
PG 36	33–35	9	41	50/52	1.105.3603.01
PG 42	39–41	10	45	57/59	1.105.4203.01
PG 48	43–45	10	48	64/64	1.105.4803.01

Z (DIN 46320-C4-Ms with multiperforated seal ring No. 7 with additional strain relief)

PG

// Please see page 89 for suitable thread seal ring
 // Please see page 72 for the EMC version of this gland

Material	Nickel plated brass
Seal ring	Buna-N (multiperforated)
Protection	IP 54, with thread seal ring IP 65
Operating Temperature	-20 °C – 80 °C (-4 °F – 176 °F)

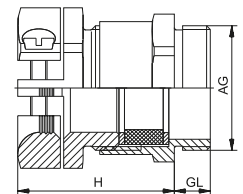
RoHS

AG	$\sqrt{\text{Ø}}$ mm	GL mm	H mm	$\sqrt{\text{Ø}}$ mm	Number
PG 9	6,5–10	6	25	17/19	1.105.0901.01
PG 11	7,5–12	6	26	20/22	1.105.1101.01
PG 13,5	8,5–13,5	6,5	27,5	22/24	1.105.1301.01
PG 16	10,5–16	6,5	28,5	24/26	1.105.1601.01
PG 21	13–20	7	33	30/33	1.105.2101.01
PG 29	19–28	8	36	40/42	1.105.2901.01
PG 36	24–34	9	41	50/52	1.105.3601.01
PG 42	34–40	10	45	57/59	1.105.4201.01
PG 48	39–46	10	48	64/64	1.105.4801.01

DIN CABLE GLANDS

SE (DIN 46320-C4 with EMC attenuation with multiperforated seal ring No. 7) PG



// Please see page 89 for suitable thread seal ring

Material	Nickel plated brass
Seal ring	Buna-N
Protection	IP 54, with thread seal ring IP 65
Operating Temperature	-20 °C – 80 °C (-4 °F – 176 °F)

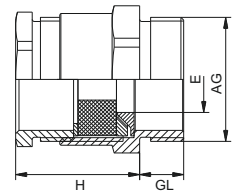

AG	\varnothing mm	GL mm	H mm	\varnothing mm	E mm	Number
PG 9	4–10	7	17	17/15	6	1.680.0906.01
PG 11	6,5–12	7	20	20/18	8	1.680.1108.01
PG 13,5	6,5–13,5	8	21	22/20	10	1.680.1310.01
PG 13,5	6,5–13,5	8	21	22/20	12	1.680.1312.01
PG 16	6,5–16	8	24	24/22	12	1.680.1612.01
PG 16	6,5–16	8	24	24/22	14	1.680.1614.01
PG 21	9–20	10	27	30/28	15	1.680.2115.01
PG 21	9–20	10	27	30/28	18	1.680.2118.01
PG 29	17–28	10	30	40/37	20	1.680.2920.01
PG 29	17–28	10	30	40/37	24	1.680.2924.01

ZSE (DIN 46320-C4 with EMC attenuation and multiperforated seal ring No. 7 with additional strain relief) PG



// Please see page 89 for suitable thread seal ring

Material	Nickel plated brass
Seal ring	Buna-N
Protection	IP 54, with thread seal ring IP 65
Operating Temperature	-20 °C – 80 °C (-4 °F – 176 °F)

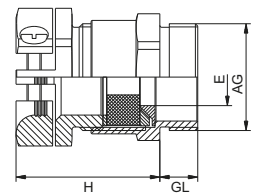

AG	\varnothing mm	GL mm	H mm	\varnothing mm	E mm	Number
PG 9	6,5–10	7	27	17/19	6	1.681.0906.01
PG 11	7,5–12	7	29	20/22	7	1.681.1107.01
PG 11	7,5–12	7	29	20/22	8	1.681.1108.01
PG 13,5	8,5–13,5	8	30	22/24	10	1.681.1310.01
PG 13,5	8,5–13,5	8	30	22/24	12	1.681.1312.01
PG 16	10,5–16	8	31	24/26	12	1.681.1612.01
PG 16	10,5–16	8	31	24/26	14	1.681.1614.01
PG 21	13–20	10	36	30/33	15	1.681.2115.01
PG 21	13–20	10	36	30/33	18	1.681.2118.01
PG 29	19–28	10	40	40/42	20	1.681.2920.01
PG 29	19–28	10	40	40/42	24	1.681.2924.01

ACCESSORIES

That finishing touch for many applications: accessories. Seemingly insignificant, but actually extremely important. For the desired functionality is often only achieved with the right accessories. That's why HUMMEL offers a huge range of accessory components which are aligned perfectly with the cable glands and have been tried and tested over many years.

In this chapter, you will find:

- // Accessories in plastic, brass and stainless steel
- // Plugs and locknuts
- // O-rings and connecting thread sealing rings
- // Various inserts (Multi, Flaka)
- // Reduction and expansion parts

The accessories come in a range of materials, sizes and thread types. HUMMEL accessories also have all relevant approvals for international markets.

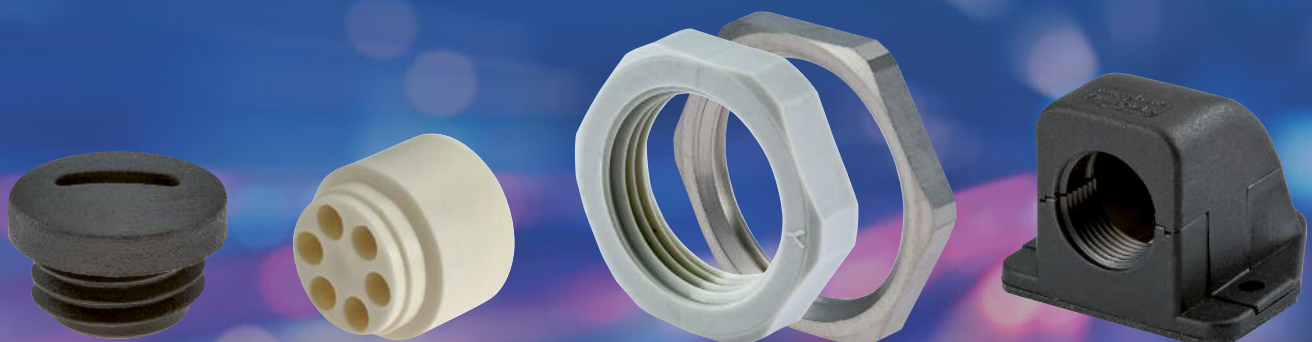

Locknut GM-FS

Metr., PG, NPT



Material	Polyamide
Operating Temperature	-40 °C – 100 °C (-40 °F – 212 °F)
Colors	grey (RAL 7035), black (RAL 9005)

// Other colors upon request

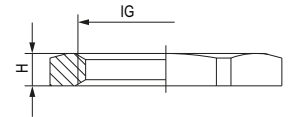

IG	H mm	 mm	Number PA grey	Number PA black
M 12 x 1,5	5	17	1.262.1200.50	1.262.1201.50
M 16 x 1,5	5	22	1.262.1600.50	1.262.1601.50
M 20 x 1,5	6	27	1.262.2000.50	1.262.2001.50
M 25 x 1,5	6,5	32	1.262.2500.50	1.262.2501.50
M 32 x 1,5	7	41	1.262.3200.50	1.262.3201.50
M 40 x 1,5	7	50	1.262.4000.50	1.262.4001.50
M 50 x 1,5	8	60	1.262.5000.50	1.262.5001.50
M 63 x 1,5	8	75	1.262.6300.50	1.262.6301.50
PG 7	5	19	1.262.0700.11	1.262.0701.11
PG 9	5	22	1.262.0900.11	1.262.0901.11
PG 11	5	24	1.262.1100.11	1.262.1101.11
PG 13,5	6	27	1.262.1300.11	1.262.1301.11
PG 16	6	30	1.262.1600.11	1.262.1601.11
PG 21	7	36	1.262.2100.11	1.262.2101.11
PG 29	7	46	1.262.2900.11	1.262.2901.11
PG 36	8	60	1.262.3600.11	1.262.3601.11
PG 42	8	65	1.262.4200.11	1.262.4201.11
PG 48	8	70	1.262.4800.11	1.262.4801.11
NPT 3/8"	7	24	1.262.3800.70	1.262.3801.70
NPT 1/2"	6	27	1.262.1200.70	1.262.1201.70
NPT 3/4"	7	32	1.262.3400.70	1.262.3401.70
NPT 1"	7	40	1.262.1000.70	1.262.1001.70

Plug V-N-FS Metr.



// Other colors upon request

Material	Polyamide
Protection	IP 54
Operating Temperature	-40 °C – 100 °C (-40 °F – 212 °F)
Colors	grey (RAL 7035), black (RAL 9005)

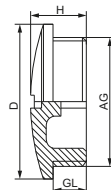

AG	GL mm	H mm	D mm	Number PA grey	Number PA black
M 12 x 1,5	6	10	15	1.251.1200.50	1.251.1201.50
M 16 x 1,5	7	11,5	20	1.251.1600.50	1.251.1601.50
M 20 x 1,5	6	9,5	25	1.251.2000.50	1.251.2001.50
M 25 x 1,5	11	15,5	30	1.251.2500.50	1.251.2501.50
M 32 x 1,5	11	16	38	1.251.3200.50	1.251.3201.50
M 40 x 1,5	13	18	46	1.251.4000.50	1.251.4001.50
M 50 x 1,5	13	18,5	56	1.251.5000.50	1.251.5001.50
M 63 x 1,5	15	19	69	1.251.6300.50	1.251.6301.50

Plug V-N-FS PG



// Other colors upon request

Material	Polyamide
Protection	IP 54
Operating Temperature	-40 °C – 100 °C (-40 °F – 212 °F)
Colors	grey (RAL 7035), black (RAL 9005)

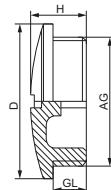

AG	GL mm	H mm	D mm	Number PA grey	Number PA black
PG 7	6	8	15	1.251.0700.11	1.251.0701.11
PG 9	6	9	19	1.251.0900.11	1.251.0901.11
PG 11	6	9	22	1.251.1100.11	1.251.1101.11
PG 13,5	6	9,5	25	1.251.1300.11	1.251.1301.11
PG 16	6	9,5	27	1.251.1600.11	1.251.1601.11
PG 21	8	11	33	1.251.2100.11	1.251.2101.11
PG 29	8	12	44	1.251.2900.11	1.251.2901.11
PG 36	10	15	55	1.251.3600.11	1.251.3601.11
PG 42	10	16	62	1.251.4200.11	1.251.4201.11
PG 48	12	16	69	1.251.4800.11	1.251.4801.11

Plug V-NE / V-NE-SD

Metr.



// Suitable O-Rings on page 88

Material	Polyamid, fiber reinforced
Operating Temperature	-20 °C – 80 °C (-4 °F – 176 °F)
O-Ring	Buna-N
Colors	black (RAL 9005)
Protection	IP 54 (V-NE) IP 68 – 10 bar / IP 69K (V-NE-SD)

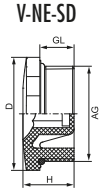
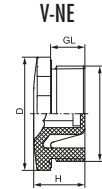

AG	GL mm	H mm	D mm	mm	mm	Number V-NE without O-Ring	Number V-NE-SD
M 12 x 1,5	8,5	13	16,5	15	6	1.255.1201.50	1.256.1201.50
M 16 x 1,5	8,5	13	20,5	19	8	1.255.1601.50	1.256.1601.50
M 20 x 1,5	9	14,5	25,5	24	8	1.255.2001.50	1.256.2001.50
M 25 x 1,5	10,5	16	30,5	28	8	1.255.2501.50	1.256.2501.50
M 32 x 1,5	11,5	17,5	38	36	8	1.255.3201.50	1.256.3201.50
M 40 x 1,5	11,5	18	48	46	8	1.255.4001.50	1.256.4001.50
M 50 x 1,5	13,5	20	60	55	8	1.255.5001.50	1.256.5001.50
M 63 x 1,5	14,5	21	75	70	8	1.255.6301.50	1.256.6301.50

Plug V-NE / V-NE-SD

PG



// Suitable O-Rings on page 88

Material	Polyamid, fiber reinforced
Operating Temperature	-20 °C – 80 °C (-4 °F – 176 °F)
O-Ring	Buna-N
Colors	black (RAL 9005)
Protection	IP 54 (V-NE) IP 68 – 10 bar / IP 69K (V-NE-SD)

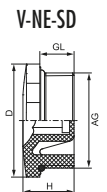
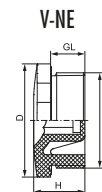

AG	GL mm	H mm	D mm	mm	mm	Number V-NE without O-Ring	Number V-NE-SD
PG 7	8,5	13	16,5	15	6	1.255.0701.11	1.256.0701.11
PG 9	8,5	13	20,5	19	8	1.255.0901.11	1.256.0901.11
PG 11	9	14,5	25,5	24	8	1.255.1101.11	1.256.1101.11
PG 13,5	9	14,5	25,5	24	8	1.255.1301.11	1.256.1301.11
PG 16	10,5	16	30,5	28	8	1.255.1601.11	1.256.1601.11
PG 21	11,5	17,5	38	36	8	1.255.2101.11	1.256.2101.11
PG 29	11,5	18	48	46	8	1.255.2901.11	1.256.2901.11
PG 36	13,5	20	60	55	8	1.255.3601.11	1.256.3601.11
PG 42	13,5	20	65	60	8	1.255.4201.11	1.256.4201.11
PG 48	14,5	21	75	70	8	1.255.4801.11	1.256.4801.11

Unthreaded sealing plug DS

Metr.



// For through holes or threaded holes

Material	Elastomer
Protection	IP 54
Operating Temperature	-20 °C – 80 °C (-4 °F – 176 °F)

RoHS

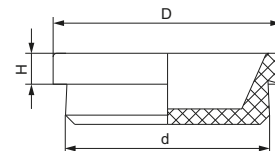

d mm	D mm	H mm	Number
12	17	5	1.250.1201.50
16	20	5	1.250.1601.50
20	25	5	1.250.2001.50
25	30	5	1.250.2501.50
32	37	5	1.250.3201.50
40	45	5	1.250.4001.50
50	56	5	1.250.5001.50
63	70	5	1.250.6301.50

Threaded sealing plug WN

Metr.



Material	Polyethylene
Protection	IP 54
Operating Temperature	-20 °C – 80 °C (-4 °F – 176 °F)

M
RoHS

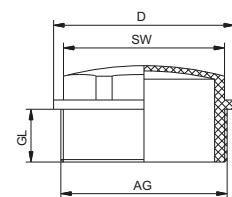

AG	GL mm	D mm	⌀ mm	Number
M 16 x 1,5	9	19,8	15	1.282.1600.50
M 20 x 1,5	12	24	19	1.282.2000.50
M 25 x 1,5	12	29,5	24	1.282.2500.50
M 32 x 1,5	14	37,5	30	1.282.3200.50
M 40 x 1,5	14	45,8	37	1.282.4000.50
M 50 x 1,5	18	55,8	46	1.282.5000.50
M 63 x 1,5	20	68,8	56	1.282.6300.50

Plug HSK-V Metr., PG, NPT



Material	Polyamide
Operating Temperature	-40 °C – 100 °C (-40 °F – 212 °F)
Colors	black (RAL 9005)



// Plugs for cable glands (HSK series)

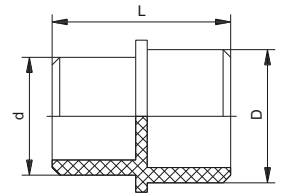

Fits the following sizes		D mm	d mm	L mm	Number
M 12 x 1,5	PG 7	6	4,5	15	1.280.0007.00
M 16 x 1,5	PG 9	7,5	5,5	17	1.280.0009.00
M 16 x 1,5/11	PG 11	9,5	6,5	19	1.280.0011.00
M 20 x 1,5	PG 13,5	11,5	8,5	19	1.280.0013.00
M 20 x 1,5/16	PG 16	13,5	11,5	19,5	1.280.0016.00
M 25 x 1,5	PG 21	17,5	15,5	23,5	1.280.0021.00
M 32 x 1,5	PG 29	24	19	26	1.280.0029.00
M 40 x 1,5	PG 36	31	25	28	1.280.0036.00
M 50 x 1,5	PG 42	37	30	28	1.280.0042.00
M 63 x 1,5	PG 48	43	34	28	1.280.0048.00

Adapter R-FS

Metr., PG



Material	Polyamide
Operating Temperature	-40 °C – 80 °C (-40 °F – 176 °F)
Colors	grey (RAL 7035)



Type A

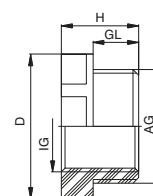

Type B

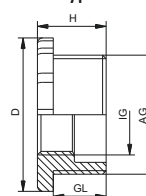

Type C

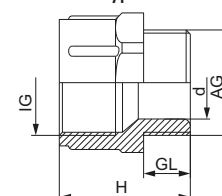

AG	IG	Type	GL mm	H mm	D mm	d mm		Number
M 16 x 1,5	M 12 x 1,5	A	9	16	24		22	1.272.1612.50
M 20 x 1,5	M 16 x 1,5	A	9	16	27		24	1.272.2016.50
M 25 x 1,5	M 20 x 1,5	A	10	17	32		29	1.272.2520.50
M 32 x 1,5	M 25 x 1,5	A	12	19	40		36	1.272.3225.50
M 40 x 1,5	M 32 x 1,5	A	12	19	51		46	1.272.4032.50
M 50 x 1,5	M 40 x 1,5	A	14	21	61		55	1.272.5040.50
M 63 x 1,5	M 50 x 1,5	A	15	22	75		65	1.272.6350.50
PG 13,5	PG 9	B	8	12	27			1.272.1309.11
PG 16	PG 9	B	10	13	29			1.272.1609.11
PG 16	PG 11	B	10	13	29			1.272.1611.11
PG 21	PG 13,5	B	11	13,5	36			1.272.2113.11
PG 21	PG 16	B	11	13,5	36			1.272.2116.11
PG 29	PG 21	B	11	13,5	46			1.272.2921.11
PG 36	PG 29	B	11	15	58			1.272.3629.11
Reducing intermediate connector								
PG 9	PG 7	C	8	14		19	15	1.236.0907.11
PG 11	PG 9	C	8	18		22,5	19	1.236.1109.11
PG 13,5	PG 11	C	9	21		25,5	22	1.236.1311.11
PG 16	PG 13,5	C	10	25		28,5	24	1.236.1613.11

Plastic

Metal

EMC

Special applications, DIN

Accessories

Ex

EMC-Ex

Ex Accessories

EXIOS

Adapter R-M-PA

Metr., PG



Material	Polyamide
Operating Temperature	-40 °C – 100 °C (-40 °F – 212 °F)
Colors	black (RAL 9005)

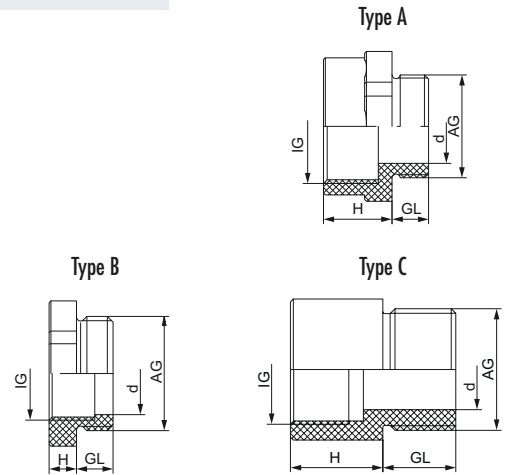

AG	IG	Typ	GL mm	H mm	d mm	 mm	Number
M 16 x 1,5	M 12 x 1,5	B	8	6	10	20	1.273.1612.50
M 20 x 1,5	M 16 x 1,5	B	8	6	13,5	25	1.273.2016.50
M 25 x 1,5	M 20 x 1,5	B	8	6	18	29	1.273.2520.50
M 32 x 1,5	M 25 x 1,5	B	10	6	23	36	1.273.3225.50
M 40 x 1,5	M 32 x 1,5	C	15	5	30		1.273.4032.50
M 50 x 1,5	M 40 x 1,5	C	15	5	38		1.273.5040.50
M 63 x 1,5	M 50 x 1,5	C	15	5	48		1.273.6350.50
M 25 x 1,5	PG 13,5	B	8	6	18	29	1.273.2513.50
M 25 x 1,5	PG 16	A	8	14	18	29	1.273.2516.50
M 32 x 1,5	PG 21	A	10	15	25	36	1.273.3221.50
M 40 x 1,5	PG 29	A	10	15	33	45	1.273.4029.50
M 50 x 1,5	PG 36	A	12	17	43	55	1.273.5036.50
M 63 x 1,5	PG 42	C	15	5	52		1.273.6342.50
PG 9	M 12 x 1,5	C	15	19	8,5		1.273.0912.11
PG 11	M 16 x 1,5	C	15	19	11,5		1.273.1116.11
PG 13,5	M 16 x 1,5	B	8	6	14	25	1.273.1316.11
PG 16	M 20 x 1,5	A	8	13	16	27	1.273.1620.11
PG 21	M 25 x 1,5	C	15	19	20,5		1.273.2125.11
PG 29	M 32 x 1,5	C	15	19	28		1.273.2932.11
PG 36	M 40 x 1,5	C	15	5	38		1.273.3640.11
PG 42	M 40 x 1,5	C	15	5	38		1.273.4240.11
PG 48	M 50 x 1,5	C	15	5	38		1.273.4850.11

Adapter E-M-PA, K-FS

Metr., PG



Material	Polyamide (Type A / Type B), Polypropylene (Type C)
Operating Temperature	-20 °C – 80 °C (-4 °F – 176 °F)
Colors	K-FS grey (RAL 7035), E-M-PA black (RAL 9005)

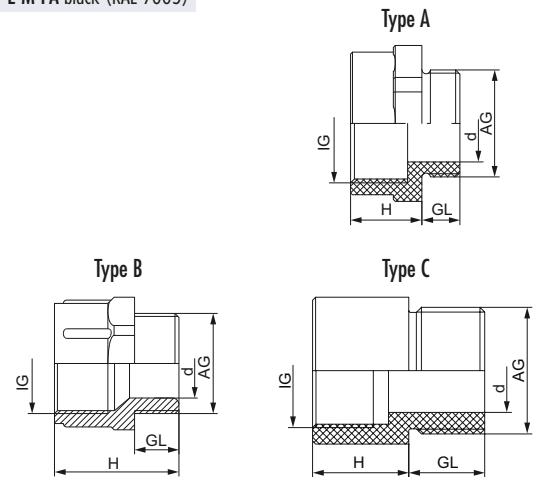

AG	IG	Typ	GL mm	H mm	d mm	 mm	Number grey	Number black
M 12 x 1,5	M 16 x 1,5	A	8	12	6,5	21		1.239.1216.50
M 16 x 1,5	M 20 x 1,5	A	8	13	9	25		1.239.1620.50
M 20 x 1,5	M 25 x 1,5	A	8	15	14	30		1.239.2025.50
M 25 x 1,5	M 32 x 1,5	C	15	15	16,5			1.239.2532.50
M 32 x 1,5	M 40 x 1,5	C	15	19,5	23			1.239.3240.50
M 40 x 1,5	M 50 x 1,5	C	15	19,5	30			1.239.4050.50
M 50 x 1,5	M 63 x 1,5	C	15	20	39			1.239.5063.50
M 12 x 1,5	PG 7	A	8	12	6,5	17		1.239.1207.50
M 16 x 1,5	PG 9	C	1	19	8,5			1.239.1609.50
M 20 x 1,5	PG 13,5	A	8	13	14	25		1.239.2013.50
M 63 x 1,5	PG 48	C	15	20	51			1.239.6348.50
PG 7	M 12 x 1,5	C	15	19	6			1.239.0712.11
PG 9	M 16 x 1,5	A	8	12	9	21		1.239.0916.11
PG 11	M 20 x 1,5	C	15	19	11,5			1.239.1120.11
PG 13,5	M 20 x 1,5	A	8	13	14	25		1.239.1320.11
PG 16	M 25 x 1,5	A	8	15	16	30		1.239.1625.11
PG 21	M 32 x 1,5	A	8	15	21	37		1.239.2132.11
PG 29	M 40 x 1,5	A	10	17	30	45		1.239.2940.11
PG 36	M 50 x 1,5	C	15	19,5	37			1.239.3650.11
PG 42	M 50 x 1,5	C	15	19,5	43			1.239.4250.11
PG 48	M 63 x 1,5	C	15	20	48			1.239.4863.11
PG 11	PG 13,5	B	8	15	12,5	24	1.233.1113.11	
PG 13,5	PG 16	B	9	16	15	27	1.233.1316.11	
PG 16	PG 21	B	10	19	16	32	1.233.1621.11	
PG 21	PG 29	B	11	21	22,5	42	1.233.2129.11	

Plastic

Metal

EMC

Special applications, DIN

Accessories

Ex

EMC-Ex

Ex Accessories

EXIOS

90° Snap Elbow

Metr., PG, NPT



Material	Polyamide
O-Ring	Buna-N
Protection	IP 68 (NEMA 6)
Operating Temperature	-20 °C – 80 °C (-4 °F – 176 °F)
Colors	grey (RAL 7035), black (RAL 9005)

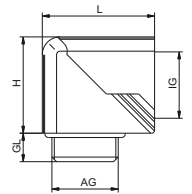

AG	IG	GL mm	H mm	L mm	$\overset{R}{\curvearrowright}$ mm		Number grey	Number black
M 16 x 1,5	M 16 x 1,5	8	23	28,5	5	19	1.316.1600.50	1.316.1601.50
M 20 x 1,5	M 20 x 1,5	9	30,5	35	7	24	1.316.2000.50	1.316.2001.50
M 25 x 1,5	M 25 x 1,5	11	40	49	10	33	1.316.2500.50	1.316.2501.50
PG 9	M 16 x 1,5	8	23	28,5	5	19	1.316.0900.11	1.316.0901.11
PG 13,5	M 20 x 1,5	9	30,5	35	7	24	1.316.1300.11	1.316.1301.11
PG 21	M 25 x 1,5	11	40	49	10	33	1.316.2100.11	1.316.2101.11
M 16 x 1,5	PG 9	8	23	28,5	5	19	1.315.1600.50	1.315.1601.50
M 20 x 1,5	PG 13,5	9	30,5	35	7	24	1.315.2000.50	1.315.2001.50
M 25 x 1,5	PG 21	11	40	49	10	33	1.315.2500.50	1.315.2501.50
M 32 x 1,5	PG 29	11	51,5	60	14	42	1.315.3200.50	1.315.3201.50
PG 9	PG 9	8	23	28,5	5	19	1.315.0900.11	1.315.0901.11
PG 11	PG 11	8	27	31,5	6	22	1.315.1100.11	1.315.1101.11
PG 13,5	PG 13,5	9	30,5	35	7	24	1.315.1300.11	1.315.1301.11
PG 16	PG 16	10	32,5	37,5	8	27	1.315.1600.11	1.315.1601.11
PG 21	PG 21	11	40	49	10	33	1.315.2100.11	1.315.2101.11
PG 29	PG 29	11	51,5	60	14	42	1.315.2900.11	1.315.2901.11
NPT 3/8"	PG 9	15	23	28,5	5	19	1.315.3800.70	1.315.3801.70
NPT 1/2"	PG 13,5	13	30,5	35	7	24	1.315.1200.70	1.315.1201.70
NPT 3/4"	PG 21	13	40	49	10	33	1.315.3400.70	1.315.3401.70
NPT 1"	PG 29	19	51,5	60	14	42	1.315.1000.70	1.315.1001.70

Breather drain KS

Metr.



Material	Polyamide
Protection	IP 54
Operating Temperature	-40 °C – 100 °C (-40 °F – 212 °F)
Colors	grey (RAL 7035), black (RAL 9005)

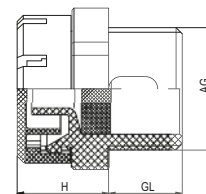

AG	GL mm	H mm	mm	Number grey	Number black
M 25 x 1,5	15	21,5	30	1.213.2500.50	1.213.2501.50

Locknut for breather drain GM-KS

Metr.



Material	Polyamide
Operating Temperature	-40 °C – 100 °C (-40 °F – 212 °F)
Colors	grey (RAL 7035), black (RAL 9005)

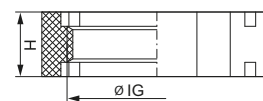

AG	H mm	mm	Number grey	Number black
M 25 x1,5	9	30	1.263.2500.50	1.263.2501.50

Foldable flange elbow KF-G Metr., PG

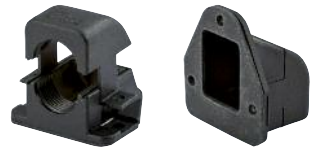

Material	Polyamide
Seal	Buna-N
Protection	IP 54
Operating Temperature	-40 °C – 110 °C (-40 °F – 230 °F)
Colors	grey (RAL 7011), black (RAL 9005)



Type 1

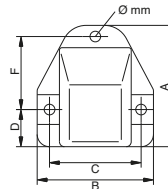

Type 2

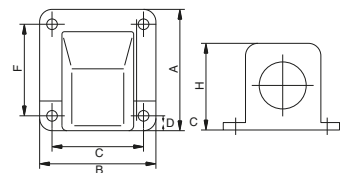

Size	Type	Ø mm	A mm	B mm	C mm	D mm	F mm	H mm	Number grey	Number black
M 16 x 1,5	1	4,3	49	47	37	15,5	29	35	1.312.1600.50	1.312.1601.50
M 20 x 1,5	1	4,5	49	47	37	15,5	29	35	1.312.2000.50	1.312.2001.50
M 25 x 1,5	1	6,0	69	65	51,5	21,5	41,5	44	1.312.2500.50	1.312.2501.50
M 32 x 1,5	2	6,5	90	78	64,5	9,5	64,5	55	1.312.3200.50	1.312.3201.50
M 40 x 1,5	2	6,5	99	94	79,5	10,5	79,5	66	1.312.4000.50	1.312.4001.50
M 50 x 1,5	2	6,5	116	101	87,5	12,5	87,5	76	1.312.5000.50	1.312.5001.50
PG 11	1	4,3	49	47	37	15,5	29	35	1.312.1100.11	1.312.1101.11
PG 16	1	4,3	49	47	37	15,5	29	35	1.312.1600.11	1.312.1601.11
PG 21	1	6,0	69	65	51,5	21,5	41,5	44	1.312.2100.11	1.312.2101.11
PG 29	2	6,5	90	78	64,5	9,5	64,5	55	1.312.2900.11	1.312.2901.11
PG 36	2	6,5	99	94	79,5	10,5	79,5	66	1.312.3600.11	1.312.3601.11
PG 48	2	6,5	116	101	87,5	12,5	87,5	76	1.312.4800.11	1.312.4801.11

Flange elbow FW-T

PG

RoHS



Material	Polyamide
O-Ring	Buna-N
Protection	IP 65
Operating Temperature	-20 °C – 95 °C (- 4 °F – 203 °F)
Colors	grey (RAL 7011)

// Metric threads with O-Ring thread seal available

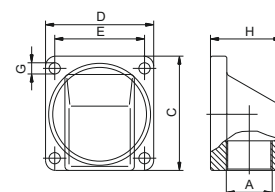

A	C mm	D mm	E mm	G mm	H mm	Number
PG 9	50	45	37	4,3	29	1.306.0900.14
PG 11	50	45	37	4,3	29	1.306.1100.14
PG 13,5	56	53	44	5,5	35	1.306.1300.14
PG 16	56	53	44	5,5	35	1.306.1600.14
PG 21	68	68	55,5	5,5	43	1.306.2100.14
PG 29	74	70	60	5,5	52	1.306.2900.14
PG 36	93	88	72	6,5	68	1.306.3600.14

Plastic

Metal

EMC

Special applications, DIN

Accessories

Ex

EMC-Ex

Ex Accessories

EXIOS

Multiple cable insertion HSK-ME

Metr., PG, NPT



Material	Elastomer
Operating Temperature	-40 °C – 100 °C (-40 °F – 212 °F)

RoHS

- // Installation instructions see page 152
- // The shown inserts are samples, more inserts upon request

! The inserts are exclusively capable for the glands of the HSK series

Slit version

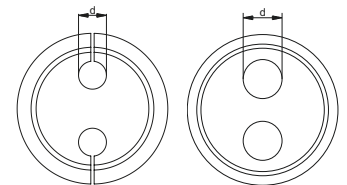

Fits the following sizes			Number of holes x d	Number	Number of holes x d	Number	Number without holes
M 12 x 1,5	PG 7 / KR PG 9		1,5*	1.089.0712.19			1.089.0799.19
M 16 x 1,5	PG 9 / KE PG 7 / KR PG 11	NPT 3/8"	4 x 1,4	1.089.0900.19	2 x 3	1.089.0901.19	1.089.0999.19
			5 x 1,6	1.089.0902.19	10 x 1,4	1.089.0904.19	
			4 x 2,3	1.089.0908.19	2 x 2*	1.089.0916.19	
M 16 x 1,5/11	PG 11 / KE PG 9 / KR PG 13,5		2 x 3	1.089.1100.19	3 x 3	1.089.1101.19	1.089.1199.19
			2 x 4	1.089.1102.19	3 x 1,5	1.089.1103.19	
M 20 x 1,5	PG 13,5 / KE PG 11 / KR PG 16	NPT 1/2"	3 x 2	1.089.1300.19	6 x 3	1.089.1301.19	1.089.1399.19
			3 x 4	1.089.1302.19	2 x 5	1.089.1303.19	
			3 x 3	1.089.1304.19	1 x 5*	1.089.1312.19	
M 20 x 1,5/16	PG 16 / KE PG 13,5 / KR PG 21	NPT 1/2" (16)	4 x 4	1.089.1602.19	5 x 4	1.089.1603.19	1.089.1699.19
			6 x 4	1.089.1604.19	2 x 6	1.089.1605.19	
			6 x 3	1.089.1607.19	3 x 4	1.089.1601.19	
			4 x 5	1.089.1611.19	2 x 4,5	1.089.1614.19	
M 25 x 1,5	PG 21 / KE PG 16	NPT 3/4"	4 x 6	1.089.2100.19	3 x 7	1.089.2101.19	1.089.2199.19
			2 x 8	1.089.2102.19	4 x 5	1.089.2103.19	
			3 x 5,2	1.089.2106.19	1 x 5,8*	1.089.2113.19	
M 32 x 1,5	PG 29	NPT 1" / NPT 1 1/4"	6 x 6,5	1.089.2900.19	4 x 9	1.089.2901.19	1.089.2999.19
			2 x 6	1.089.2905.19			
M 40 x 1,5	PG 36	NPT 1 1/2"	5 x 9	1.089.3600.19	7 x 9	1.089.3601.19	1.089.3699.19
			6 x 8	1.089.3602.19	2 x 15	1.089.3603.19	
M 50 x 1,5	PG 42		3 x 14*	1.089.4203.19	2 x 17	1.089.4205.19	1.089.4299.19
M 63 x 1,5	PG 48		8 x 10	1.089.4800.19	6 x 12	1.089.4801.19	1.089.4899.19

* Slit version to accommodate terminated cable

Flat cable insertion HSK-Flaka

Metr., PG, NPT



Material Elastomer

RoHS

Operating Temperature -40 °C – 100 °C (-40 °F – 212 °F)

- // Installation instructions see page 152
- // The shown inserts are samples, more inserts upon request

! The inserts are exclusively capable for the glands of the HSK series

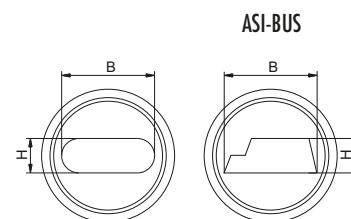

Fits the following sizes			w x h mm	Number	w x h mm	Number
M 20 x 1,5	PG 13,5	NPT 1/2"	(ASI-BUS) 10,4 x 4,2	1.091.1300.19		
M 20 x 1,5/16	PG 16 / KE PG 13,5 / KR PG 21	NPT 1/2" (16)	14 x 6	1.091.1600.19	11,5 x 5	1.091.1601.19
M 20 x 1,5/16	PG 16 / KE PG 13,5 / KR PG 21	NPT 1/2" (16)	12 x 7	1.091.1602.19		
M 25 x 1,5	PG 21 / KE PG 16	NPT 3/4"	14 x 6	1.091.2100.19	14 x 7	1.091.2101.19
M 32 x 1,5	PG 29	NPT 1" / 1 1/4"	22 x 8	1.091.2900.19		
M 40 x 1,5	PG 36	NPT 1 1/2"	28,5 x 10	1.091.3600.19	29 x 5,5	1.091.3601.19
M 50 x 1,5	PG 42		33,5 x 11,5	1.091.4200.19		
M 63 x 1,5	PG 48		38 x 12	1.091.4800.19		

Plastic

Metal

EMC

Special applications, DIN

Accessories

Ex

EMC-Ex

Ex Accessories

EXIOS

O-Ring

Metr., PG, NPT

RoHS



O-Ring Buna-N

Material	Buna-N
Operating Temperature	-30 °C – 120 °C (-22 °F – 248 °F)

O-Ring FKM

Material	FKM
Operating Temperature	-40 °C – 200 °C (-40 °F – 392 °F)

O-Ring VMQ

Material	VMQ (Silicone)
Operating Temperature	-60 °C – 250 °C (-76 °F – 482 °F)

// O-Ring for HSK-K

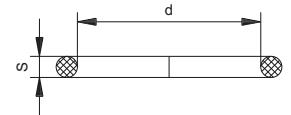

Fits the following sizes	d mm	S mm	Number Buna-N	Number FKM	Number VMQ
M 12 x 1,5	10	1,5	1.321.1200.57	1.321.1200.58	1.321.1200.59
M 16 x 1,5	12	1,5	1.321.1600.57	1.321.1600.58	1.321.1600.59
M 20 x 1,5	17	1,8	1.321.2000.57	1.321.2000.58	1.321.2000.59
M 25 x 1,5	23	2	1.321.2500.57	1.321.2500.58	1.321.2500.59
M 32 x 1,5	30	2,5	1.321.3200.57	1.321.3200.58	1.321.3200.59
M 40 x 1,5	35	2	1.321.4000.57	1.321.4000.58	1.321.4000.59
M 50 x 1,5	43	2	1.321.5000.57	1.321.5000.58	1.321.5000.59
M 63 x 1,5	55	2	1.321.6300.57	1.321.6300.58	1.321.6300.59
PG 7	10	1,5	1.321.0700.17	1.321.0700.21	1.321.0700.22
PG 9	12	1,5	1.321.0900.17	1.321.0900.21	1.321.0900.22
PG 11	16	1,5	1.321.1100.17	1.321.1100.21	1.321.1100.22
PG 13,5	17	1,8	1.321.1300.17	1.321.1300.21	1.321.1300.22
PG 16	18	1,5	1.321.1600.17	1.321.1600.21	1.321.1600.22
PG 21	26	2	1.321.2100.17	1.321.2100.21	1.321.2100.22
PG 29	33	2	1.321.2900.17	1.321.2900.21	1.321.2900.22
PG 36	43	2	1.321.3600.17	1.321.3600.21	1.321.3600.22
PG 42	50	2	1.321.4200.17	1.321.4200.21	1.321.4200.22
PG 48	55	2	1.321.4800.17	1.321.4800.21	1.321.4800.22
NPT 3/8"	13	2	1.321.3800.77	1.321.3800.78	1.321.3800.79
NPT 1/2"	19	1,8	1.321.1200.77	1.321.1200.78	1.321.1200.79
NPT 3/4"	23	2,5	1.321.3400.77	1.321.3400.78	1.321.3400.79
NPT 1"	30	2,5	1.321.1000.77	1.321.1000.78	1.321.1000.79
NPT 1 1/4"	38	2,5	1.321.5400.77	1.321.5400.78	1.321.5400.79
NPT 1 1/2"	45	2,5	1.321.6400.77	1.321.6400.78	1.321.6400.79

Thread Seal Ring

Metr.

RoHS



// GFK thread seal see page 149

Thread Seal Ring PE

Material	Polyethylene
Operating Temperature	-30 °C – 70 °C (-22 °F – 158 °F)

Thread Seal Ring HD

Material	Fiber-reinforced plastic
Operating Temperature	-40 °C – 300 °C (-40 °F – 572 °F)

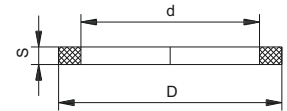

Fits the following sizes	d mm	D mm	S mm	Number Polyethylene	Number Fiber-reinforced plastic
M 12 x 1,5	12	16	2	1.325.1200.59	1.325.1200.50
M 16 x 1,5	16	20	2	1.325.1600.59	1.325.1600.50
M 20 x 1,5	20	25	2	1.325.2000.59	1.325.2000.50
M 25 x 1,5	25	31	2	1.325.2500.59	1.325.2500.50
M 32 x 1,5	32	38	2	1.325.3200.59	1.325.3200.50
M 40 x 1,5	40	52,7	2	1.325.4000.59	1.325.4000.50
M 50 x 1,5	50	58	2	1.325.5000.59	1.325.5000.50
M 63 x 1,5	63	72	2	1.325.6300.59	1.325.6300.50

Thread Seal Ring

PG

RoHS

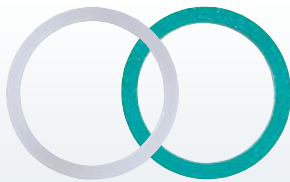

Thread Seal Ring PE

Material	Polyethylene
Operating Temperature	-30 °C – 70 °C (-22 °F – 158 °F)

Thread Seal Ring HD

Material	Fiber-reinforced plastic
Operating Temperature	-40 °C – 300 °C (-40 °F – 572 °F)

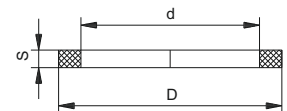

Fits the following sizes	d mm	D mm	S Polyethylene mm	S Fiber-reinforced plastic mm	Number Polyethylene	Number Fiber-reinforced plastic
PG 7	12,5	16,5	2	1,5	1.325.0700.19	1.325.0700.20
PG 9	15,2	19	2	1,5	1.325.0900.19	1.325.0900.20
PG 11	18,6	22,5	2	1,5	1.325.1100.19	1.325.1100.20
PG 13,5	20,4	25	2	1,5	1.325.1300.19	1.325.1300.20
PG 16	22,5	27	2	1,5	1.325.1600.19	1.325.1600.20
PG 21	28,3	33,5	2	2	1.325.2100.19	1.325.2100.20
PG 29	37	43,5	2	2	1.325.2900.19	1.325.2900.20
PG 36	47	55	2	2	1.325.3600.19	1.325.3600.20
PG 42	54	63	2	2	1.325.4200.19	1.325.4200.20
PG 48	59,3	69	2	2	1.325.4800.19	1.325.4800.20

Locknut GM-Ms Metr., PG, G



Material Nickel plated brass

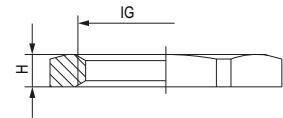

IG	H mm	mm	Number	IG	H mm	mm	Number	IG	H mm	mm	Number
M 12 x 1,5	2,8	15	1.161.1200.50	M 100 x 2	11	115	1.161.1000.50	PG 42	5,0	60	1.161.4200.01
M 16 x 1,5	2,8	19	1.161.1600.50	M 110 x 2	11	125	1.161.1100.50	PG 48	5,5	64	1.161.4800.01
M 20 x 1,5	3,0	23	1.161.2000.50	PG 7	2,8	15	1.161.0700.01	G 2 1/2"	7	80	1.106.5200.99
M 25 x 1,5	3,5	29	1.161.2500.50	PG 9	2,8	18	1.161.0900.01	G 3"	8	95	1.106.3000.99
M 32 x 1,5	4,0	36	1.161.3200.50	PG 11	3,0	21	1.161.1100.01	G 4"	11	125	1.106.4000.99
M 40 x 1,5	4,5	45	1.161.4000.50	PG 13,5	3,0	23	1.161.1300.01				
M 50 x 1,5	5,5	55	1.161.5000.50	PG16	3,0	26	1.161.1600.01				
M 63 x 1,5	6,0	70	1.161.6300.50	PG 21	3,5	32	1.161.2100.01				
M 75 x 1,5	8,0	85	1.161.7500.50	PG 29	4,0	41	1.161.2900.01				
M 80 x 2	8,0	90	1.161.8000.50	PG 36	5,0	51	1.161.3600.01				
M 90 x 2	8,0	100	1.161.9000.50								

Locknut GM-EMC Metr., PG



Material Nickel plated brass

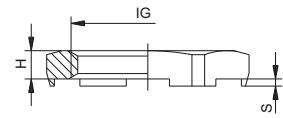

IG	H mm	mm	S mm	Number	IG	H mm	mm	S mm	Number
M 12 x 1,5	2,8	15	0,7	1.167.1200.50	PG 7	2,8	15	0,7	1.167.0700.01
M 16 x 1,5	2,8	19	0,7	1.167.1600.50	PG 9	2,8	18	0,7	1.167.0900.01
M 20 x 1,5	3,0	24	0,7	1.167.2000.50	PG 11	3,0	21	0,7	1.167.1100.01
M 25 x 1,5	3,5	30	0,7	1.167.2500.50	PG 13,5	3,0	23	0,7	1.167.1300.01
M 32 x 1,5	4,5	36	0,7	1.167.3200.50	PG 16	3,0	26	0,7	1.167.1600.01
M 40 x 1,5	5,0	46	0,7	1.167.4000.50	PG 21	3,5	32	0,7	1.167.2100.01
M 50 x 1,5	5,0	60	0,7	1.167.5000.50	PG 29	4,0	41	0,7	1.167.2900.01
M 63 x 1,5	6,0	70	0,7	1.167.6300.50	PG 36	5,0	51	0,7	1.167.3600.01
					PG 42	5,0	60	0,7	1.167.4200.01
					PG 48	5,5	64	0,7	1.167.4800.01

Plug V-N-Ms

Metr., PG



Material	Nickel plated brass
Protection	IP 54

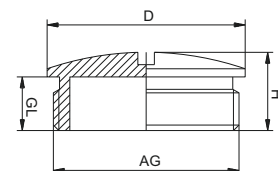

AG	GL mm	H mm	D mm	Number
M 12 x 1,5	5	7,5	14	1.052.1200.50
M 16 x 1,5	5	9,0	18	1.052.1600.50
M 20 x 1,5	6,5	9,5	22	1.052.2000.50
M 25 x 1,5	7	11,0	28	1.052.2500.50
M 32 x 1,5	8	12,0	35	1.052.3200.50
M 40 x 1,5	8,5	13,0	44	1.052.4000.50
M 50 x 1,5	9	15,0	54	1.052.5000.50
M 63 x 1,5	10	16,0	67	1.052.6300.50

AG	GL mm	H mm	D mm	Number
PG 7	5	8	14	1.052.0700.01
PG 9	6	9	17	1.052.0900.01
PG 11	6	9	20	1.052.1100.01
PG 13,5	6,5	9,5	22	1.052.1300.01
PG 16	6,5	9,5	24	1.052.1600.01
PG 21	7	11	30	1.052.2100.01
PG 29	8	12	39	1.052.2900.01
PG 36	9	15	50	1.052.3600.01
PG 42	10	16	57	1.052.4200.01
PG 48	10	16	64	1.052.4800.01

Plug V-N-Ms-SD

Metr., PG

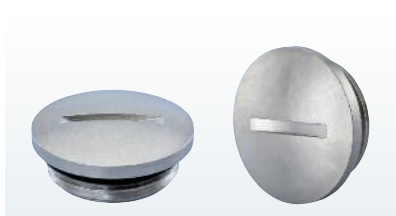

// Other O-Ring materials upon request

Material	Nickel plated brass
O-Ring	Buna-N
Protection	IP 68
Operating Temperature	-40 °C – 80 °C 40 °F – 176 °F)

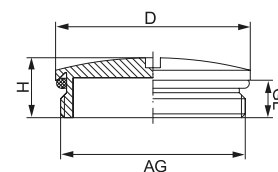

AG	GL mm	H mm	D mm	Number
M 12 x 1,5	6,5	9,5	14	1.052.1201.50
M 16 x 1,5	6	9	20	1.052.1601.50
M 20 x 1,5	6,5	9,5	24	1.052.2001.50
M 25 x 1,5	7	11	28	1.052.2501.50
M 32 x 1,5	8	12,5	35	1.052.3201.50
M 40 x 1,5	8	12	45	1.052.4001.50
M 50 x 1,5	9	15	55	1.052.5001.50
M 63 x 1,5	10	16	68	1.052.6301.50

AG	GL mm	H mm	D mm	Number
PG 7	4,8	8	14	1.052.0701.01
PG 9	5,5	9	17	1.052.0901.01
PG 11	5,5	9	20	1.052.1101.01
PG 13,5	6	9,5	22	1.052.1301.01
PG 16	6	9,5	24	1.052.1601.01
PG 21	6,5	11	30	1.052.2101.01
PG 29	7,5	12	39	1.052.2901.01
PG 36	9	15	50	1.052.3601.01
PG 42	10	16	57	1.052.4201.01
PG 48	10	16	64	1.052.4801.01

Plug V-NE-Ms Metr.



// Other O-Ring materials upon request

Material	Nickel plated brass
V-NE-Ms	
Protection	IP 54
V-NE-Ms-SD / V-NE-Ms-SD-FKM	
Protection	IP 68 – 10 bar / IP 69K
O-Ring / Operating Temperature	Buna-N / -20 °C – 95 °C (-4 °F – 203 °F) FKM / -20 °C – 180 °C (-4 °F – 356 °F)

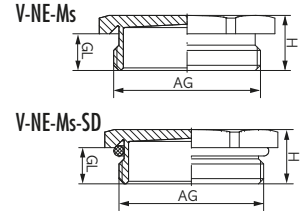

AG	GL mm	H mm	mm	Number V-NE-Ms without O-Ring	Number V-NE-Ms-SD -20 °C – 95 °C	Number V-NE-Ms-SD-FKM -20 °C – 180 °C
M 12 x 1,5	6,5	9,5	14	1.155.1200.50	1.156.1200.50	1.157.1200.50
M 16 x 1,5	6	9	19	1.155.1600.50	1.156.1600.50	1.157.1600.50
M 20 x 1,5	6	9,5	22	1.155.2000.50	1.156.2000.50	1.157.2000.50
M 25 x 1,5	7	10,5	30	1.155.2500.50	1.156.2500.50	1.157.2500.50
M 32 x 1,5	8	12,5	41	1.155.3200.50	1.156.3200.50	1.157.3200.50
M 40 x 1,5	8	13	46	1.155.4000.50	1.156.4000.50	1.157.4000.50
M 50 x 1,5	9	15	55	1.155.5000.50	1.156.5000.50	1.157.5000.50
M 63 x 1,5	10	16,5	70	1.155.6300.50	1.156.6300.50	1.157.6300.50

Plug V-NE-Ms PG



// Other O-Ring materials upon request

Material	Nickel plated brass
V-NE-Ms	
Protection	IP 54
V-NE-Ms-SD / V-NE-Ms-SD-FKM	
Protection	IP 68 – 10 bar / IP 69K
O-Ring / Operating Temperature	Buna-N / -20 °C – 95 °C (-4 °F – 203 °F) FKM / -20 °C – 180 °C (-4 °F – 356 °F)

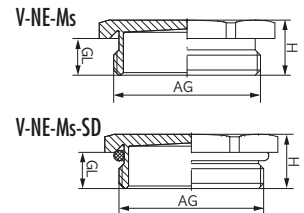

AG	GL mm	H mm	mm	Number V-NE-Ms without O-Ring	Number V-NE-Ms-SD -20 °C – 95 °C	Number V-NE-Ms-SD-FKM -20 °C – 180 °C
PG 7	5	8	14	1.155.0700.01	1.156.0700.01	1.157.0700.01
PG 9	6	9	17	1.155.0900.01	1.156.0900.01	1.157.0900.01
PG 11	6	9,5	20	1.155.1100.01	1.156.1100.01	1.157.1100.01
PG 13,5	6,5	10	22	1.155.1300.01	1.156.1300.01	1.157.1300.01
PG 16	6,5	10	24	1.155.1600.01	1.156.1600.01	1.157.1600.01
PG 21	7	10,5	30	1.155.2100.01	1.156.2100.01	1.157.2100.01
PG 29	8	12,5	41	1.155.2900.01	1.156.2900.01	1.157.2900.01
PG 36	8	13	50	1.155.3600.01	1.156.3600.01	1.157.3600.01
PG 42	9	15	58	1.155.4200.01	1.156.4200.01	1.157.4200.01
PG 48	10	16,5	65	1.155.4800.01	1.156.4800.01	1.157.4800.01

Adapter R-H

Metr., PG



Material

Nickel plated brass



RoHS

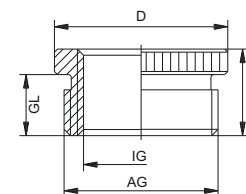

AG	IG	GL mm	H mm	D mm	Number
M 16 x 1,5	M 12 x 1,5	6,0	8,5	18	1.076.1612.50
M 20 x 1,5	M 12 x 1,5	6,5	9,0	24	1.076.2012.50
M 20 x 1,5	M 16 x 1,5	6,5	9,0	24	1.076.2016.50
M 25 x 1,5	M 16 x 1,5	7,0	10,0	30	1.076.2516.50
M 25 x 1,5	M 20 x 1,5	7,0	10,0	30	1.076.2520.50
M 32 x 1,5	M 20 x 1,5	8,0	11,5	39	1.076.3220.50
M 32 x 1,5	M 25 x 1,5	8,0	11,5	39	1.076.3225.50
M 40 x 1,5	M 25 x 1,5	8,0	11,5	43	1.076.4025.50
M 40 x 1,5	M 32 x 1,5	9,0	12,5	43	1.076.4032.50
M 50 x 1,5	M 32 x 1,5	10,0	14,0	57	1.076.5032.50
M 50 x 1,5	M 40 x 1,5	10,0	14,0	57	1.076.5040.50
M 63 x 1,5	M 40 x 1,5	10,0	14,0	64	1.076.6340.50
M 63 x 1,5	M 50 x 1,5	10,0	14,0	64	1.076.6350.50
PG 9	PG 7	6	8,5	17	1.071.0907.01
PG 11	PG 7	6	8,5	20	1.071.1107.01
PG 11	PG 9	6	8,5	20	1.071.1109.01
PG 13,5	PG 9	6,5	9	22	1.071.1309.01
PG 13,5	PG 11	6,5	9	22	1.071.1311.01
PG 16	PG 9	6,5	9,5	24	1.071.1609.01
PG 16	PG 11	6,5	9,5	24	1.071.1611.01
PG 16	PG 13,5	6,5	9,5	24	1.071.1613.01
PG 21	PG 11	7	10	30	1.071.2111.01
PG 21	PG 13,5	7	10	30	1.071.2113.01
PG 21	PG 16	7	10	30	1.071.2116.01
PG 29	PG 16	8	11,5	39	1.071.2916.01
PG 29	PG 21	8	11,5	39	1.071.2921.01
PG 36	PG 21	9	12,5	50	1.071.3621.01
PG 36	PG 29	9	12,5	50	1.071.3629.01
PG 42	PG 29	10	14	57	1.071.4229.01
PG 42	PG 36	10	14	57	1.071.4236.01
PG 48	PG 36	10	14	64	1.071.4836.01
PG 48	PG 42	10	14	64	1.071.4842.01

Adapter RSD-Ms Metr.



// Other O-Ring materials upon request

Material	Nickel plated brass
O-Ring	Buna-N
Operating Temperature	-40 °C – 100 °C (-40 °F – 212 °F)

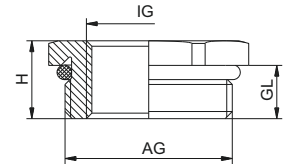

AG	IG	GL mm	H mm	mm	Number
M 16 x 1,5	M 12 x 1,5	5	8	17	1.077.1612.50
M 20 x 1,5	M 12 x 1,5	6	9	22	1.077.2012.50
M 20 x 1,5	M 16 x 1,5	6	9	22	1.077.2016.50
M 25 x 1,5	M 16 x 1,5	7	10	29	1.077.2516.50
M 25 x 1,5	M 20 x 1,5	7	10	29	1.077.2520.50
M 32 x 1,5	M 16 x 1,5	8	11	34	1.077.3216.50
M 32 x 1,5	M 20 x 1,5	8	11	34	1.077.3220.50
M 32 x 1,5	M 25 x 1,5	8	11	34	1.077.3225.50
M 40 x 1,5	M 20 x 1,5	8	12	43	1.077.4020.50
M 40 x 1,5	M 25 x 1,5	8	12	43	1.077.4025.50
M 40 x 1,5	M 32 x 1,5	8	12	43	1.077.4032.50

AG	IG	GL mm	H mm	mm	Number
M 50 x 1,5	M 25 x 1,5	9	13	55	1.077.5025.50
M 50 x 1,5	M 32 x 1,5	9	13	55	1.077.5032.50
M 50 x 1,5	M 40 x 1,5	9	13	55	1.077.5040.50
M 63 x 1,5	M 32 x 1,5	10	14	65	1.077.6332.50
M 63 x 1,5	M 40 x 1,5	10	14	65	1.077.6340.50
M 63 x 1,5	M 50 x 1,5	10	14	65	1.077.6350.50

Adapter RSD-Ms PG



// Other O-Ring materials upon request

Material	Nickel plated brass
O-Ring	Buna-N
Operating Temperature	-40 °C – 100 °C (-40 °F – 212 °F)

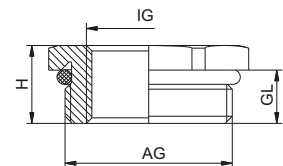

AG	IG	GL mm	H mm	mm	Number
PG 9	PG 7	6	8,8	17	1.077.0907.01
PG 11	PG 7	6	9	20	1.077.1107.01
PG 11	PG 9	6	9	20	1.077.1109.01
PG 13,5	PG 9	6,5	9,5	22	1.077.1309.01
PG 13,5	PG 11	6,5	9,5	22	1.077.1311.01
PG 16	PG 9	6,5	9,5	24	1.077.1609.01
PG 16	PG 11	6,5	9,5	24	1.077.1611.01
PG 16	PG 13,5	6,5	9,5	24	1.077.1613.01
PG 21	PG 11	7	10,3	30	1.077.2111.01
PG 21	PG 13,5	7	10,3	30	1.077.2113.01
PG 21	PG 16	7	10,3	30	1.077.2116.01

AG	IG	GL mm	H mm	mm	Number
PG 29	PG 16	8	11,5	40	1.077.2916.01
PG 29	PG 21	8	11,5	40	1.077.2921.01
PG 36	PG 21	9	12,5	50	1.077.3621.01
PG 36	PG 29	9	12,5	50	1.077.3629.01
PG 42	PG 29	10	13,5	57	1.077.4229.01
PG 42	PG 36	10	13,5	57	1.077.4236.01
PG 48	PG 36	10	13,5	64	1.077.4836.01
PG 48	PG 42	10	13,5	64	1.077.4842.01

Adapter RE-Ms

Metr., PG



Material: Nickel plated brass

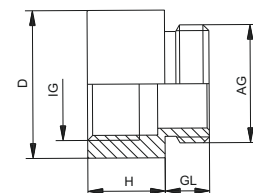

AG	IG	GL mm	H mm	D mm	Number
M 16 x 1,5	PG 9	6	10,5	20	1.039.1609.01
M 20 x 1,5	PG 11	6,5	12,5	22	1.039.2011.01
M 20 x 1,5	PG 13,5	6,5	12,5	22	1.039.2013.01
M 20 x 1,5	PG 16	6,5	12,5	24	1.039.2016.01
M 25 x 1,5	PG 16	6,5	12,5	28	1.039.2516.01
M 25 x 1,5	PG 21	6,5	14,5	30	1.039.2521.01
M 32 x 1,5	PG 29	7	16	39	1.039.3229.01

AG	IG	GL mm	H mm	D mm	Number
PG 9	M 16 x 1,5	6	10,5	20	1.039.0916.01
PG 11	M 20 x 1,5	6,5	12,5	22	1.039.1120.01
PG 13,5	M 20 x 1,5	6,5	12,5	22	1.039.1320.01
PG 16	M 25 x 1,5	6,5	14,5	27	1.039.1625.01

Adapter RE-Ms

Metr., PG



Material: Nickel plated brass

O-Ring: Buna-N

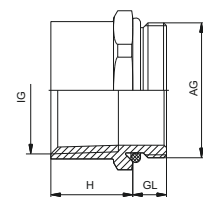

AG	IG	GL mm	H mm	mm	Number
M 16 x 1,5	NPT 1/2"	6	17	24	1.171.1612.50
M 20 x 1,5	NPT 1/2"	6	17	24	1.171.2012.50
M 25 x 1,5	NPT 1/2"	7	8	30	1.171.2512.50
M 25 x 1,5	NPT 3/4"	7	19	30	1.171.2534.50
M 32 x 1,5	NPT 1"	8	25	40	1.171.3210.50
M 32 x 1,5	NPT 1 1/4"	8	25	46	1.171.3254.50

AG	IG	GL mm	H mm	mm	Number
PG 11	NPT 1/2"	6	16,7	24	1.171.1112.01
PG 13,5	NPT 1/2"	6,5	17	24	1.171.1312.01
PG 16	NPT 1/2"	6,5	16,5	24	1.171.1612.01
PG 21	NPT 1/2"	7	8	30	1.171.2112.01
PG 21	NPT 3/4"	7	17	30	1.171.2134.01
PG 29	NPT 1"	8	12	40	1.171.2910.01

Adapter E-Ms

Metr.



Material

Nickel plated brass

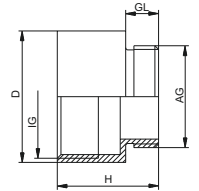

AG	IG	GL mm	H mm	D mm	Number
M 12 x 1,5	M 16 x 1,5	5	15	18	1.033.1216.50
M 16 x 1,5	M 20 x 1,5	6	17,5	22	1.033.1620.50
M 20 x 1,5	M 25 x 1,5	6,5	19	27	1.033.2025.50
M 25 x 1,5	M 32 x 1,5	6,5	21	34	1.033.2532.50
M 32 x 1,5	M 40 x 1,5	7	23	42	1.033.3240.50
M 40 x 1,5	M 50 x 1,5	9	31	53	1.033.4050.50
M 50 x 1,5	M 63 x 1,5	9	31	66	1.033.5063.50

Adapter E-Ms

PG



Material

Nickel plated brass

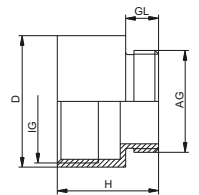

AG	IG	GL mm	H mm	D mm	Number
PG 7	PG 9	5	15	17	1.033.0709.01
PG 9	PG 11	6	16,5	20	1.033.0911.01
PG 9	PG 13,5	6	17,5	22	1.033.0913.01
PG 11	PG 13,5	6	17,5	22	1.033.1113.01
PG 11	PG 16	6	18,5	24	1.033.1116.01
PG 11	PG 21	6	20,5	30	1.033.1121.01
PG 13,5	PG 16	6,5	19	24	1.033.1316.01
PG 13,5	PG 21	6,5	21	30	1.033.1321.01
PG 16	PG 21	6,5	21	30	1.033.1621.01
PG 16	PG 29	6,5	22,5	39	1.033.1629.01
PG 21	PG 29	7	23	39	1.033.2129.01

Compression clamp KLE

Metr.



Material Nickel plated brass

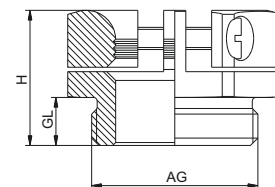

AG	Ø mm	GL mm	H mm	Ø mm	Number
M 12 x 1,5	5-7,5	5,5	15,0	16	1.143.1200.50
M 16 x 1,5	7-10	6,0	16,0	19	1.143.1600.50
M 20 x 1,5	10-14	6,5	18,0	24	1.143.2000.50
M 25 x 1,5	12-21,5	8,0	21,0	34	1.143.2500.50
M 32 x 1,5	16-27	8,0	22,0	42	1.143.3200.50
M 40 x 1,5	22-33	9,5	25,5	52	1.143.4000.50

Compression clamp KLE

PG

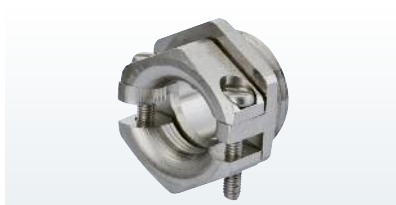

Material Nickel plated brass

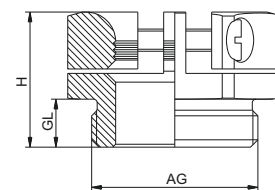

AG	Ø mm	GL mm	H mm	Ø mm	Number
PG 7	5,5-8	5,5	14,8	16	1.143.0700.01
PG 9	6,5-10	6	16,6	19	1.143.0900.01
PG 11	7,5-12	6	17,3	22	1.143.1100.01
PG 13,5	8,5-14	6,5	17,8	24	1.143.1300.01
PG 16	9,5-16	6,5	18,3	26	1.143.1600.01
PG 21	12-21	7,5	20,8	33	1.143.2100.01
PG 29	19-30	8	21,8	42	1.143.2900.01
PG 36	25-37	9,5	25,3	52	1.143.3600.01
PG 42	31-43	10	26,3	59	1.143.4200.01
PG 48	35-48	11	27,3	64	1.143.4800.01

Flange elbow FW-ZN Metr.



Material	Zinc die casting
O-Ring	Buna-N
Protection	IP 65
Operating Temperature	-20 °C – 95 °C (-4 °F – 203 °F)

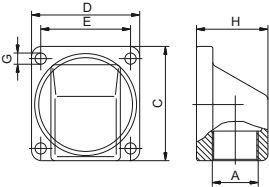

A	C mm	D mm	E mm	G mm	H mm	Number
M 20 x 1,5	56	53	44	5,5	35	1.306.2000.50
M 25 x 1,5	65	63	54	5,5	42	1.306.2500.50
M 32 x 1,5	75	71	60	5,5	52	1.306.3200.50
M 50 x 1,5	93	89	72	6,5	69	1.306.5000.50
M 63 x 1,5	114	96	84	6,5	74	1.306.6300.50

Flange elbow FW-ZN PG

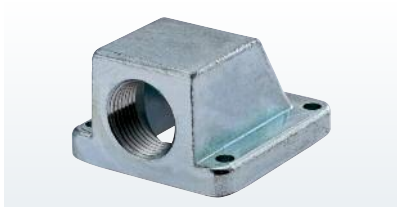

Material	Zinc die casting
O-Ring	Buna-N
Protection	IP 65
Operating Temperature	-20 °C – 95 °C (-4 °F – 203 °F)

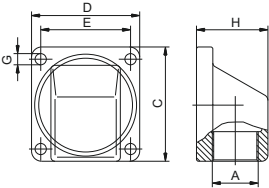

A	C mm	D mm	E mm	G mm	H mm	Number
PG 9	50	45	37	4,3	30	1.306.0900.05
PG 11	50	45	37	4,3	30	1.306.1100.05
PG 13,5	56	53	44	5,5	35	1.306.1300.05
PG 16	56	53	44	5,5	35	1.306.1600.05
PG 21	65	63	54	5,5	42	1.306.2100.05
PG 29	74	70	60	5,5	52	1.306.2900.05
PG 36	94	89	72	6,5	69	1.306.3600.05
PG 42	114	96	84	6,5	74	1.306.4200.05
PG 48	114	96	84	6,5	74	1.306.4800.05

Locknut GM-INOX

Metr.



Material

INOX 1.4305



- // Other sizes upon request
- // INOX 1.4404 upon request

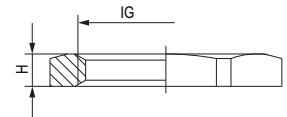

IG	H mm	 mm	Number
M 12 x 1,5	2,8	15	1.161.1200.58
M 16 x 1,5	2,8	19	1.161.1600.58
M 20 x 1,5	3	24	1.161.2000.58
M 25 x 1,5	3,5	30	1.161.2500.58
M 32 x 1,5	3,5	36	1.161.3200.58
M 40 x 1,5	5	46	1.161.4000.58
M 50 x 1,5	5	57	1.161.5000.58
M 63 x 1,5	6	70	1.161.6300.58

Locknut GM-INOX

PG



Material

INOX 1.4305



- // Other sizes upon request
- // INOX 1.4404 upon request

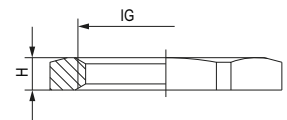

IG	H mm	 mm	Number
PG 7	2,8	17	1.161.0700.08
PG 9	2,8	22	1.161.0900.08
PG 11	3	22	1.161.1100.08
PG 13,5	3	24	1.161.1300.08
PG 16	3	27	1.161.1600.08
PG 21	3,5	32	1.161.2100.08
PG 29	4	41	1.161.2900.08
PG 36	5	50	1.161.3600.08

Plug V-INOX Metr.



Material	INOX 1.4305
O-Ring	Buna-N /FKM /VMQ
Protection	IP 68 – 10 bar /IP 69K (NEMA 6 – 150 PSIG)
Operating Temperature	-20 °C – 95 °C (-4 °F – 203 °F) (Buna-N), -20 °C – 180 °C (-4 °F – 356 °F) (FKM), -60 °C – 180 °C (-76 °F – 356 °F) (VMQ)

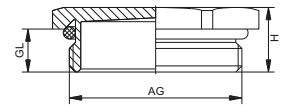

AG	GL mm	H mm	⌀ mm	Number V-INOX-NBR -20 °C – 95 °C	Number V-INOX-FKM -20 °C – 180 °C	Number V-INOX-VMQ -60 °C – 180 °C
M 12 x 1,5	6,5	9,5	14	1.152.1200.50	1.153.1200.50	1.154.1200.50
M 16 x 1,5	6	9	19	1.152.1600.50	1.153.1600.50	1.154.1600.50
M 20 x 1,5	6	9,5	22	1.152.2000.50	1.153.2000.50	1.154.2000.50
M 25 x 1,5	7	10,5	30	1.152.2500.50	1.153.2500.50	1.154.2500.50
M 32 x 1,5	8	12,5	41	1.152.3200.50	1.153.3200.50	1.154.3200.50
M 40 x 1,5	8	13	46	1.152.4000.50	1.153.4000.50	1.154.4000.50

Plug V-INOX PG



Material	INOX 1.4305
O-Ring	Buna-N /FKM /VMQ
Protection	IP 68 – 10 bar /IP 69K (NEMA 6 – 150 PSIG)
Operating Temperature	-20 °C – 95 °C (-4 °F – 203 °F) (Buna-N), -20 °C – 180 °C (-4 °F – 356 °F) (FKM), -60 °C – 180 °C (-76 °F – 356 °F) (VMQ)

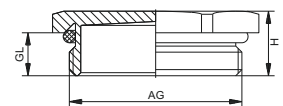

AG	GL mm	H mm	⌀ mm	Number V-INOX-NBR -20 °C – 95 °C	Number V-INOX-FKM -20 °C – 180 °C	Number V-INOX-VMQ -60 °C – 180 °C
PG 7	5	8	14	1.152.0700.01	1.153.0700.01	1.154.0700.01
PG 9	6	9	17	1.152.0900.01	1.153.0900.01	1.154.0900.01
PG 11	6	9,5	20	1.152.1100.01	1.153.1100.01	1.154.1100.01
PG 13,5	6,5	10	22	1.152.1300.01	1.153.1300.01	1.154.1300.01
PG 16	6,5	10	24	1.152.1600.01	1.153.1600.01	1.154.1600.01
PG 21	7	10,5	30	1.152.2100.01	1.153.2100.01	1.154.2100.01
PG 29	8	12,5	41	1.152.2900.01	1.153.2900.01	1.154.2900.01
PG 36	8	13	50	1.152.3600.01	1.153.3600.01	1.154.3600.01

Adapter RS-INOX / RSD-INOX

Metr.



Material	INOX 1.4305
O-Ring	Buna-N
Operating Temperature	-20 °C – 95 °C (-4 °F – 203 °F)



// Other O-Ring materials upon request

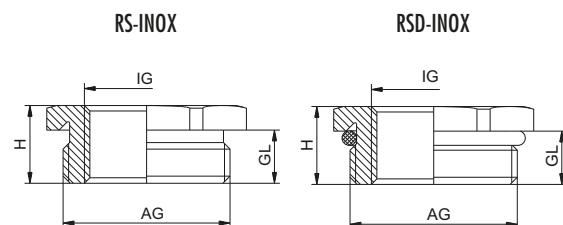

AG	IG	GL mm	H mm	mm	Number RS-INOX without O-Ring	Number RSD-INOX
M 16 x 1,5	M 12 x 1,5	6	9	19	1.094.1612.50	1.097.1612.50
M 20 x 1,5	M 12 x 1,5	6	9,5	22	1.094.2012.50	1.097.2012.50
M 20 x 1,5	M 16 x 1,5	6	9,5	22	1.094.2016.50	1.097.2016.50
M 25 x 1,5	M 16 x 1,5	7	10,5	30	1.094.2516.50	1.097.2516.50
M 25 x 1,5	M 20 x 1,5	7	10,5	30	1.094.2520.50	1.097.2520.50
M 32 x 1,5	M 16 x 1,5	8	12,5	41	1.094.3216.50	1.097.3216.50
M 32 x 1,5	M 20 x 1,5	8	12,5	41	1.094.3220.50	1.097.3220.50
M 32 x 1,5	M 25 x 1,5	8	12,5	41	1.094.3225.50	1.097.3225.50
M 40 x 1,5	M 20 x 1,5	8	13	46	1.094.4020.50	1.097.4020.50
M 40 x 1,5	M 25 x 1,5	8	13	46	1.094.4025.50	1.097.4025.50
M 40 x 1,5	M 32 x 1,5	8	13	46	1.094.4032.50	1.097.4032.50
M 50 x 1,5	M 25 x 1,5	9	15	55	1.094.5025.50	1.097.5025.50
M 50 x 1,5	M 32 x 1,5	9	15	55	1.094.5032.50	1.097.5032.50
M 50 x 1,5	M 40 x 1,5	9	15	55	1.094.5040.50	1.097.5040.50
M 63 x 1,5	M 32 x 1,5	10	16,5	65	1.094.6332.50	1.097.6332.50
M 63 x 1,5	M 40 x 1,5	10	16,5	65	1.094.6340.50	1.097.6340.50
M 63 x 1,5	M 50 x 1,5	10	16,5	65	1.094.6350.50	1.097.6350.50

Plastic

Metal

EMC

Special applications, DIN

Accessories

Ex

EMC-Ex

Ex Accessories

EXIOS

Adapter RS-INOX / RSD-INOX

PG



Material	INOX 1.4305
O-Ring	Buna-N
Operating Temperature	-20 °C – 95 °C (-4 °F – 203 °F)



// Other O-Ring materials upon request

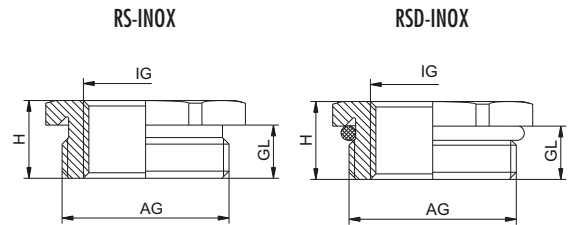

AG	IG	GL mm	H mm	 mm	Number RS-INOX without O-Ring	Number RSD-INOX
PG 9	PG 7	6	8,8	17	1.094.0907.01	1.097.0907.01
PG 11	PG 7	6	9	22	1.094.1107.01	1.097.1107.01
PG 11	PG 9	6	9	22	1.094.1109.01	1.097.1109.01
PG 13,5	PG 9	6,5	9,5	22	1.094.1309.01	1.097.1309.01
PG 13,5	PG 11	6,5	9,5	22	1.094.1311.01	1.097.1311.01
PG 16	PG 9	6,5	9,5	24	1.094.1609.01	1.097.1609.01
PG 16	PG 11	6,5	9,5	24	1.094.1611.01	1.097.1611.01
PG 16	PG 13,5	6,5	9,5	24	1.094.1613.01	1.097.1613.01
PG 21	PG 11	7	10,3	30	1.094.2111.01	1.097.2111.01
PG 21	PG 13,5	7	10,3	30	1.094.2113.01	1.097.2113.01
PG 21	PG 16	7	10,3	30	1.094.2116.01	1.097.2116.01
PG 29	PG 16	8	11,5	41	1.094.2916.01	1.097.2916.01
PG 29	PG 21	8	11,5	41	1.094.2921.01	1.097.2921.01
PG 36	PG 21	9	12,5	50	1.094.3621.01	1.097.3621.01
PG 36	PG 29	9	12,5	50	1.094.3629.01	1.097.3629.01
PG 42	PG 29	10	13,5	60	1.094.4229.01	1.097.4229.01
PG 42	PG 36	10	13,5	60	1.094.4236.01	1.097.4236.01
PG 48	PG 36	10	13,5	65	1.094.4836.01	1.097.4836.01
PG 48	PG 42	10	13,5	65	1.094.4842.01	1.097.4842.01

Ex CABLE GLANDS



HUMMEL offers a wide range of cable glands for explosion protection areas. This includes cable glands for ignition protection types Ex d and Ex e. For areas where “Increased Safety” (Ex e) is prescribed, HUMMEL offers plastic and metal cable glands, also with multi or flat cable inserts. Cable glands for ignition type Ex d meet the requirements for “Pressure-tight Encapsulation”. This prevents transfer of an explosion in the housing interior to the exterior.

In this chapter, you will find:

- // HSK-K-Ex-Active, the plastic cable gland for ex-areas
- // Ex e metal cable glands with various inserts
- // Ex d metal cable glands for pressure-tight encapsulation

HUMMEL has many years of experience in handling components for explosion-protection areas. This is why we have a sophisticated range of explosion area products in a range of materials and designs.



Ex e PLASTIC CABLE GLANDS

HSK-K-Ex-Active

Metr.



Material	Polyamide, fiber reinforced
Seal	Buna-N
O-Ring	Buna-N
Protection	IP 68 – 10 bar within the specified clamping range
Operating Temperature	-20 °C – 85 °C (-4 °F – 185 °F)
Colors	black (RAL 9005) / blue-black (RAL 5012)

// FKM and VMQ O-Ring upon request



II 2G Ex eb IIC Gb
II 1D Ex ta IIIC Da

Class I Div 2 Groups A, B, C, D
Class II Div 1 Groups E, F, G

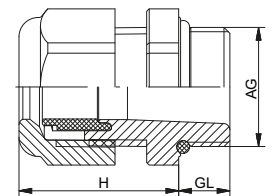

AG	\varnothing mm	H mm	\varnothing mm	GL mm	Number black	Number blue-black	GL mm	Number black elongated	Number blue-black elongated
M 12 x 1,5	3–6,5	21	15	8	1.292.1201.50	1.292.1202.50	15	1.292.1201.30	1.292.1202.30
M 12 x 1,5	2–5	21	15	8	1.292.1201.51	1.292.1202.51	15	1.292.1201.31	1.292.1202.31
M 16 x 1,5	4–8	22	19	8	1.292.1601.50	1.292.1602.50	15	1.292.1601.30	1.292.1602.30
M 16 x 1,5	3–6	22	19	8	1.292.1601.51	1.292.1602.51	15	1.292.1601.31	1.292.1602.31
M 16 x 1,5	5–10	25	22	8	1.292.1611.50	1.292.1612.50	15	1.292.1611.30	1.292.1612.30
M 16 x 1,5	3–7	25	22	8	1.292.1611.51	1.292.1612.51	15	1.292.1611.31	1.292.1612.31
M 20 x 1,5	6–12	27	24	9	1.292.2001.50	1.292.2002.50	15	1.292.2001.30	1.292.2002.30
M 20 x 1,5	5–9	27	24	9	1.292.2001.51	1.292.2002.51	15	1.292.2001.31	1.292.2002.31
M 20 x 1,5	10–14	28	27	9	1.292.2016.50	1.292.2017.50	15	1.292.2016.30	1.292.2017.30
M 20 x 1,5	7–12	28	27	9	1.292.2016.51	1.292.2017.51	15	1.292.2016.31	1.292.2017.31
M 25 x 1,5	13–18	31	33	11	1.292.2501.50	1.292.2502.50	15	1.292.2501.30	1.292.2502.30
M 25 x 1,5	9–16	31	33	11	1.292.2501.51	1.292.2502.51	15	1.292.2501.31	1.292.2502.31
M 32 x 1,5	18–25	39	42	11	1.292.3201.50	1.292.3202.50	15	1.292.3201.30	1.292.3202.30
M 32 x 1,5	13–20	39	42	11	1.292.3201.51	1.292.3202.51	15	1.292.3201.31	1.292.3202.31
M 40 x 1,5	22–32	48	53	13	1.292.4001.50	1.292.4002.50	18	1.292.4001.30	1.292.4002.30
M 40 x 1,5	20–26	48	53	13	1.292.4001.51	1.292.4002.51	18	1.292.4001.31	1.292.4002.31
M 50 x 1,5	32–38	49	60	13	1.292.5001.50	1.292.5002.50	18	1.292.5001.30	1.292.5002.30
M 50 x 1,5	25–31	49	60	13	1.292.5001.51	1.292.5002.51	18	1.292.5001.31	1.292.5002.31
M 63 x 1,5	37–44	49	65/68	14	1.292.6301.50	1.292.6302.50	18	1.292.6301.30	1.292.6302.30
M 63 x 1,5	29–35	49	65/68	14	1.292.6301.51	1.292.6302.51	18	1.292.6301.31	1.292.6302.31

HSK-K-Ex-Active

NPT



Material	Polyamide, fiber reinforced
Seal	Buna-N
O-Ring	Buna-N
Protection	IP 68 – 10 bar within the specified clamping range
Operating Temperature	-20 °C – 85 °C (-4 °F – 185 °F)
Colors	black (RAL 9005) / blue-black (RAL 5012)

// FKM and VMQ O-Ring upon request



II 2G Ex eb IIC Gb
II 1D Ex ta IIIC Da

Class I Div 2 Groups A, B, C, D
Class II Div 1 Groups E, F, G

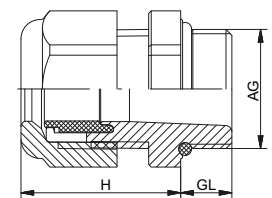

AG	∅k mm	GL mm	H mm	⌀ mm	Number black	Number blue-black
NPT 3/8"	4–8	15	22	19 / 22	1.292.3801.70	1.292.3802.70
NPT 3/8"	3–6	15	22	19 / 22	1.292.3801.71	1.292.3802.71
NPT 1/2"	6–12	13	27	24	1.292.1201.70	1.292.1202.70
NPT 1/2"	5–9	13	27	24	1.292.1201.71	1.292.1202.71
NPT 1/2" (16)	10–14	13	28	27	1.292.1216.70	1.292.1217.70
NPT 1/2" (16)	7–12	13	28	27	1.292.1216.71	1.292.1217.71
NPT 3/4"	13–18	14	31	33	1.292.3401.70	1.292.3402.70
NPT 3/4"	9–16	14	31	33	1.292.3401.71	1.292.3402.71
NPT 1"	18–25	19	39	42	1.292.1001.70	1.292.1002.70
NPT 1"	13–20	19	39	42	1.292.1001.71	1.292.1002.71
NPT 1 1/4"	18–25	16	39	42 / 46	1.292.5401.70	1.292.5402.70
NPT 1 1/4"	13–20	16	39	42 / 46	1.292.5401.71	1.292.5402.71
NPT 1 1/2"	22–32	20	48	53	1.292.6401.70	1.292.6402.70
NPT 1 1/2"	20–26	20	48	53	1.292.6401.71	1.292.6402.71

Ex e PLASTIC CABLE GLANDS

HSK-K-Multi-Ex-Active

Metr., NPT



Material	Polyamide, fiber reinforced
Seal	Elastomer
O-Ring	Buna-N
Protection	IP 68 – 10 bar within the specified clamping range
Operating Temperature	-20 °C – 85 °C (-4 °F – 185 °F)
Colors	black (RAL 9005) / blue-black (RAL 5012)

- // FKM and VMQ O-Ring upon request
- // The inserts shown are samples, more inserts upon request

Installation Instructions: Cable diameter should not be less than 20% of hole diameter and the difference between cable diameter and hole should never exceed 1 mm (.04").



II 2G Ex eb IIC Gb
II 1D Ex ta IIIC Da

Class I Div 2 Groups A, B, C, D
Class II Div 1 Groups E, F, G

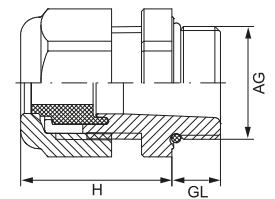

AG	GL mm	H mm	mm	Number of holes x d	Number black	Number blue-black	Number of holes x d	Number black	Number blue-black
M 16 x 1,5	8	22	19	4 x 1,4	1.581.1600.51	1.581.1600.52	2 x 3	1.581.1601.51	1.581.1601.52
M 20 x 1,5	9	27	24	6 x 3	1.581.2001.51	1.581.2001.52	2 x 5	1.581.2003.51	1.581.2003.52
M 25 x 1,5	11	31	33	4 x 6	1.581.2500.51	1.581.2500.52	3 x 7	1.581.2501.51	1.581.2501.52
M 32 x 1,5	11	39	42	6 x 6,5	1.581.3200.51	1.581.3200.52	4 x 9	1.581.3201.51	1.581.3201.52
M 40 x 1,5	13	48	53	7 x 9	1.581.4001.51	1.581.4001.52	2 x 15	1.581.4003.51	1.581.4003.52
M 50 x 1,5	13	49	60		1.581.5099.51	1.581.5099.52			
M 63 x 1,5	14	49	65/68	6 x 12	1.581.6301.51	1.581.6301.52	3 x 18	1.581.6302.51	1.581.6302.52
NPT 3/8"	15	22	19/22	4 x 1,4	1.581.3800.71	1.581.3800.72	2 x 3	1.581.3801.71	1.581.3801.72
NPT 1/2"	13	27	24	3 x 4	1.581.1202.71	1.581.1202.72	2 x 5	1.581.1203.71	1.581.1203.72
NPT 1/2" (16)	13	28	27	6 x 4	1.581.1220.71	1.581.1220.72	2 x 6	1.581.1221.71	1.581.1221.72
NPT 3/4"	14	31	33	4 x 6	1.581.3400.71	1.581.3400.72	3 x 7	1.581.3401.71	1.581.3401.72
NPT 1"	19	39	42	6 x 6,5	1.581.1000.71	1.581.1000.72	4 x 9	1.581.1001.71	1.581.1001.72
NPT 1 1/4"	16	39	42/46		1.581.5499.71	1.581.5499.72			
NPT 1 1/2"	20	48	53	5 x 9	1.581.6400.71	1.581.6400.72	7 x 9	1.581.6401.71	1.581.6401.72

HSK-K-Flaka-Ex-Active

Metr., NPT



Material	Polyamide, fiber reinforced
Seal	Elastomer
O-Ring	Buna-N
Protection	IP 68 – 10 bar within the specified clamping range
Operating Temperature	-20 °C – 85 °C (-4 °F – 185 °F)
Colors	black (RAL 9005) / blue-black (RAL 5012)

- // FKM and VMQ O-Ring upon request
- // The inserts shown are samples, more inserts upon request

Installation Instructions: The clamping range of the cable used may not deviate from the manufacturer-specified minimum values by more than 1 mm in length and 1 mm in width. The geometries of the cable and the insert hole must be compatible (semicircular or straight at the sides).



II 2G Ex eb IIC Gb
II 1D Ex ta IIIC Da

Class I Div 2 Groups A, B, C, D
Class II Div 1 Groups E, F, G

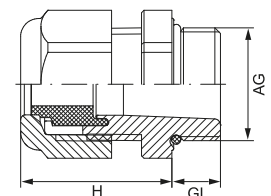

AG	mm	H	mm	Ø	mm	Dimensions	Number	Number	Dimensions	Number	Number
						w x h	black	blue-black	w x h	black	blue-black
						mm			mm		
M 20 x 1,5	9	28	27			12 x 7	1.582.2017.51	1.582.2017.52	14 x 6	1.582.2018.51	1.582.2018.52
M 25 x 1,5	11	31	33			14 x 6	1.582.2500.51	1.582.2500.52	14,5 x 7,2	1.582.2501.51	1.582.2501.52
M 32 x 1,5	11	39	42			22 x 8	1.582.3200.51	1.582.3200.52			
M 40 x 1,5	13	48	53			28,5 x 10	1.582.4000.51	1.582.4000.52	29 x 5,5	1.582.4001.51	1.582.4001.52
M 40 x 1,5	13	48	53			30,5 x 12	1.582.4002.51	1.582.4002.52	31 x 7,5	1.582.4003.51	1.582.4003.52
M 50 x 1,5	13	49	60			33,5 x 11,5	1.582.5000.51	1.582.5000.52			
NPT 1/2" (16)	13	28	27			12 x 7	1.582.1217.71	1.582.1217.72	14x 6	1.582.1218.71	1.582.1218.72
NPT 3/4"	14	31	33			14 x 6	1.582.3400.71	1.582.3400.72			
NPT 1"	19	39	42			22 x 8	1.582.1000.71	1.582.1000.72			
NPT 1 1/4"	16	39	42/46			22 x 8	1.582.5400.71	1.582.5400.72			
NPT 1 1/2"	16	48	53			28,5 x 10	1.582.6400.71	1.582.6400.72	29 x 5,5	1.582.6401.71	1.582.6401.72
NPT 1 1/2"	20	48	53			30,5 x 12	1.582.6402.71	1.582.6402.72	31 x 7,5	1.582.6403.71	1.582.6403.72

Ex e PLASTIC CABLE GLANDS

HSK-K-MZ-Ex Metr.



Material	Polyamide-AL
Seal	Buna-N
O-Ring	Buna-N
Protection	IP 68 – 10 bar / IP 69K (NEMA 6 – 150 PSIG)
Operating Temperature	-20 °C – 70 °C (-4 °F – 158 °F)



II 2G 1D

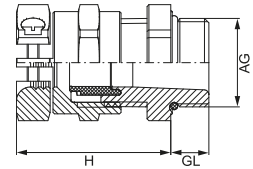

AG	\varnothing mm	GL mm	H mm	 mm	Number
M 16 x 1,5	4–8	15	29	19	1.215.1601.50
M 20 x 1,5	7–12	15	35,5	24	1.215.2001.50
M 25 x 1,5	13–18	11	41	33	1.215.2501.50
M 32 x 1,5	18–25	11	49	42	1.215.3201.50
M 40 x 1,5	22–32	13	58	53	1.215.4001.50
M 50 x 1,5	32–38	13	61,5	60	1.215.5001.50
M 63 x 1,5	37–44	14	62	65 / 68	1.215.6301.50

HSK-K-MZ-Ex

PG



Material	Polyamide-AL
Seal	Buna-N
O-Ring	Buna-N
Protection	IP 68 – 10 bar / IP 69K (NEMA 6 – 150 PSIG)
Operating Temperature	-20 °C – 70 °C (-4 °F – 158 °F)

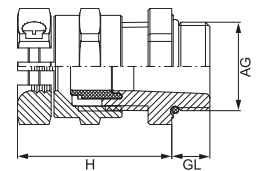

AG	\varnothing mm	GL mm	H mm	 mm	Number
PG 9	4–8	15	29	19	1.215.0901.14
PG 11	6–10	15	32,5	22	1.215.1101.14
PG 13,5	7–12	15	35,5	24	1.215.1301.14
PG 16	10–14	10	37,5	27	1.215.1601.14
PG 21	13–18	11	41	33	1.215.2101.14
PG 29	18–25	11	49	42	1.215.2901.14
PG 36	22–32	13	58	53	1.215.3601.14
PG 42	32–38	13	61,5	60	1.215.4201.14
PG 48	37–44	14	62	65	1.215.4801.14

Plastic
Metal
EMC
Special applications, DIN
Accessories
Ex
EMC-Ex
Ex Accessories
EXIOS

Ex e METAL CABLE GLANDS

HSK-M-Ex / HSK-M-PVDF-Ex

Metr.



Material	Nickel plated brass
Clamping insert	Polyamide / PVDF
Seal	Buna-N / FKM
O-Ring	Buna-N / FKM
Protection	IP 68 – 10 bar / IP 69K (NEMA 6 – 150 PSIG)
Operating Temperature	-20 °C – 95 °C (-4 °F – 203 °F) (PA) -60 °C – 95 °C (-76 °F – 203 °F) (PA) / -20 °C – 130 °C (-4 °F – 266 °F) (PVDF)

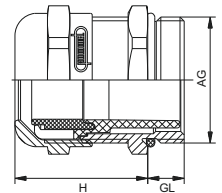

AG	\varnothing mm	GL mm	H mm	\varnothing mm	Number HSK-M-Ex -20 °C – 95 °C	Number HSK-M-Ex -60 °C – 95 °C	Number HSK-M-PVDF-Ex -20 °C – 130 °C
M 12 x 1,5	3–6,5	6,5	19	14	1.610.1200.50	1.640.1200.50	1.660.1200.50
M 12 x 1,5	2–5	6,5	19	14	1.610.1200.51	1.640.1200.51	1.660.1200.51
M 16 x 1,5	4–8	6	21	17 / 19	1.610.1600.50	1.640.1600.50	1.660.1600.50
M 16 x 1,5	2–6	6	21	17 / 19	1.610.1600.51	1.640.1600.51	1.660.1600.51
M 16 x 1,5	6–10	6	22	20	1.610.1611.50	1.640.1611.50	1.660.1611.50
M 16 x 1,5	3–7	6	22	20	1.610.1611.51	1.640.1611.51	1.660.1611.51
M 20 x 1,5	7–12	6	23	22	1.610.2000.50	1.640.2000.50	1.660.2000.50
M 20 x 1,5	5–9	6	23	22	1.610.2000.51	1.640.2000.51	1.660.2000.51
M 20 x 1,5	10–14	6	24	24	1.610.2016.50	1.640.2016.50	1.660.2016.50
M 20 x 1,5	7–12	6	24	24	1.610.2016.51	1.640.2016.51	1.660.2016.51
M 25 x 1,5	14–18	7	26	30	1.610.2500.50	1.640.2500.50	1.660.2500.50
M 25 x 1,5	10–16	7	26	30	1.610.2500.51	1.640.2500.51	1.660.2500.51
M 32 x 1,5	20–25	8	31	40	1.610.3200.50	1.640.3200.50	1.660.3200.50
M 32 x 1,5	13–20	8	31	40	1.610.3200.51	1.640.3200.51	1.660.3200.51
M 40 x 1,5	22–32	8	37	50	1.610.4000.50	1.640.4000.50	1.660.4000.50
M 40 x 1,5	20–26	8	37	50	1.610.4000.51	1.640.4000.51	1.660.4000.51
M 50 x 1,5	32–38	9	37	57	1.610.5000.50	1.640.5000.50	
M 50 x 1,5	25–31	9	37	57	1.610.5000.51	1.640.5000.51	
M 63 x 1,5	37–44	10	38	64 / 68	1.610.6300.50	1.640.6300.50	
M 63 x 1,5	29–35	10	38	64 / 68	1.610.6300.51	1.640.6300.51	

HSK-M-Ex / HSK-M-PVDF-Ex

Metr.-elongated



Material	Nickel plated brass
Clamping insert	Polyamide / PVDF
Seal	Buna-N / FKM
O-Ring	Buna-N / FKM
Protection	IP 68 – 10 bar / IP 69K (NEMA 6 – 150 PSIG)
Operating Temperature	-20 °C – 95 °C (-4 °F – 203 °F) (PA) -60 °C – 95 °C (-76 °F – 203 °F) (PA) / -20 °C – 130 °C (-4 °F – 266 °F) (PVDF)

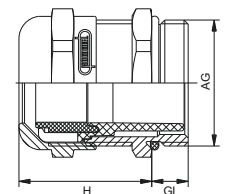

AG	∅k mm	GL mm	H mm	⌀ mm	Number HSK-M-Ex -20 °C – 95 °C	Number HSK-M-Ex -60 °C – 95 °C	Number HSK-M-PVDF-Ex -20 °C – 130 °C
M 12 x 1,5	3–6,5	10	19	14	1.610.1200.30	1.640.1200.30	1.660.1200.30
M 12 x 1,5	2–5	10	19	14	1.610.1200.31	1.640.1200.31	1.660.1200.31
M 16 x 1,5	4–8	10	21	17 / 19	1.610.1600.30	1.640.1600.30	1.660.1600.30
M 16 x 1,5	2–6	10	21	17 / 19	1.610.1600.31	1.640.1600.31	1.660.1600.31
M 16 x 1,5	6–10	10	22	20	1.610.1611.30	1.640.1611.30	1.660.1611.30
M 16 x 1,5	3–7	10	22	20	1.610.1611.31	1.640.1611.31	1.660.1611.31
M 20 x 1,5	7–12	10	23	22	1.610.2000.30	1.640.2000.30	1.660.2000.30
M 20 x 1,5	5–9	10	23	22	1.610.2000.31	1.640.2000.31	1.660.2000.31
M 20 x 1,5	10–14	10	24	24	1.610.2016.30	1.640.2016.30	1.660.2016.30
M 20 x 1,5	7–12	10	24	24	1.610.2016.31	1.640.2016.31	1.660.2016.31
M 25 x 1,5	14–18	12	26	30	1.610.2500.30	1.640.2500.30	1.660.2500.30
M 25 x 1,5	10–16	12	26	30	1.610.2500.31	1.640.2500.31	1.660.2500.31
M 32 x 1,5	20–25	12	31	40	1.610.3200.30	1.640.3200.30	1.660.3200.30
M 32 x 1,5	13–20	12	31	40	1.610.3200.31	1.640.3200.31	1.660.3200.31
M 40 x 1,5	22–32	15	37	50	1.610.4000.30	1.640.4000.30	1.660.4000.30
M 40 x 1,5	20–26	15	37	50	1.610.4000.31	1.640.4000.31	1.660.4000.31
M 50 x 1,5	32–38	15	37	57	1.610.5000.30	1.640.5000.30	
M 50 x 1,5	25–31	15	37	57	1.610.5000.31	1.640.5000.31	
M 63 x 1,5	37–44	15	38	64 / 68	1.610.6300.30	1.640.6300.30	
M 63 x 1,5	29–35	15	38	64 / 68	1.610.6300.31	1.640.6300.31	

Ex e METAL CABLE GLANDS

HSK-M-Ex / HSK-M-PVDF-Ex

PG, NPT



Material	Nickel plated brass
Clamping insert	Polyamide / PVDF
Seal	Buna-N / FKM
O-Ring	Buna-N / FKM
Protection	IP 68 – 10 bar / IP 69K (NEMA 6 – 150 PSIG)
Operating Temperature	-20 °C – 95 °C (-4 °F – 203 °F) (PA) -60 °C – 95 °C (-76 °F – 203 °F) (PA) / -20 °C – 130 °C (-4 °F – 266 °F) (PVDF)

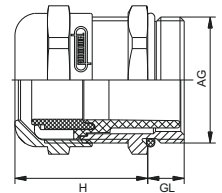

AG	\varnothing mm	GL mm	H mm	\varnothing mm	Number HSK-M-Ex -20 °C – 95 °C	Number HSK-M-Ex -60 °C – 95 °C	Number HSK-M-PVDF-Ex -20 °C – 130 °C
PG 7	3–6,5	5	19	14	1.610.0700.01	1.640.0700.01	1.660.0700.01
PG 7	2–5	5	19	14	1.610.0700.15	1.640.0700.15	1.660.0700.15
PG 9	4–8	6	21	17	1.610.0900.01	1.640.0900.01	1.660.0900.01
PG 9	2–6	6	21	17	1.610.0900.15	1.640.0900.15	1.660.0900.15
PG 11	6–10	6	22	20	1.610.1100.01	1.640.1100.01	1.660.1100.01
PG 11	3–7	6	22	20	1.610.1100.15	1.640.1100.15	1.660.1100.15
PG 13,5	7–12	6,5	24	22	1.610.1300.01	1.640.1300.01	1.660.1300.01
PG 13,5	5–9	6,5	24	22	1.610.1300.15	1.640.1300.15	1.660.1300.15
PG 16	10–14	6,5	23	24	1.610.1600.01	1.640.1600.01	1.660.1600.01
PG 16	7–12	6,5	23	24	1.610.1600.15	1.640.1600.15	1.660.1600.15
PG 21	14–18	7	24	30	1.610.2100.01	1.640.2100.01	1.660.2100.01
PG 21	10–16	7	24	30	1.610.2100.15	1.640.2100.15	1.660.2100.15
PG 29	20–25	8	29	40	1.610.2900.01	1.640.2900.01	1.660.2900.01
PG 29	13–20	8	29	40	1.610.2900.15	1.640.2900.15	1.660.2900.15
PG 36	22–32	8	35	50	1.610.3600.01	1.640.3600.01	1.660.3600.01
PG 36	20–26	8	35	50	1.610.3600.15	1.640.3600.15	1.660.3600.15
PG 42	32–38	9	37	57	1.610.4200.01	1.640.4200.01	1.660.4200.01
PG 42	25–31	9	37	57	1.610.4200.15	1.640.4200.15	1.660.4200.15
PG 48	37–44	10	38	64	1.610.4800.01	1.640.4800.01	1.660.4800.01
PG 48	29–35	10	38	64	1.610.4800.15	1.640.4800.15	1.660.4800.15
NPT 3/8"	4–8	15	21	17 / 19	1.610.3800.70	1.640.3800.70	1.660.3800.70
NPT 3/8"	2–6	15	21	17 / 19	1.610.3800.71	1.640.3800.71	1.660.3800.71
NPT 1/2"	7–12	13	24	22 / 24	1.610.1200.70	1.640.1200.70	1.660.1200.70
NPT 1/2"	5–9	13	24	22 / 24	1.610.1200.71	1.640.1200.71	1.660.1200.71
NPT 3/4"	14–18	13	25	30	1.610.3400.70	1.640.3400.70	1.660.3400.70
NPT 3/4"	10–16	13	25	30	1.610.3400.71	1.640.3400.71	1.660.3400.71
NPT 1"	20–25	19	29	40	1.610.1000.70	1.640.1000.70	1.660.1000.70
NPT 1"	13–20	19	29	40	1.610.1000.71	1.640.1000.71	1.660.1000.71

HSK-M-Ex / HSK-M-PVDF-Ex

PG-elongated



Material	Messing vernickelt
Clamping insert	Polyamide / PVDF
Seal	Buna-N / FKM
O-Ring	Buna-N / FKM
Protection	IP 68 – 10 bar / IP 69K (NEMA 6 – 150 PSIG)
Operating Temperature	-20 °C – 95 °C (-4 °F – 203 °F) (PA) -60 °C – 95 °C (-76 °F – 203 °F) (PA) / -20 °C – 130 °C (-4 °F – 266 °F) (PVDF)

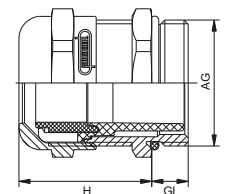

AG	\varnothing mm	GL mm	H mm	\varnothing mm	Number HSK-M-Ex -20 °C – 95 °C	Number HSK-M-Ex -60 °C – 95 °C	Number HSK-M-PVDF-Ex -20 °C – 130 °C
PG 7	3–6,5	10	19	14	1.610.0700.60	1.640.0700.60	1.660.0700.60
PG 7	2–5	10	19	14	1.610.0700.61	1.640.0700.61	1.660.0700.61
PG 9	4–8	10	21	17	1.610.0900.60	1.640.0900.60	1.660.0900.60
PG 9	2–6	10	21	17	1.610.0900.61	1.640.0900.61	1.660.0900.61
PG 11	6–10	10	22	20	1.610.1100.60	1.640.1100.60	1.660.1100.60
PG 11	3–7	10	22	20	1.610.1100.61	1.640.1100.61	1.660.1100.61
PG 13,5	7–12	10	24	22	1.610.1300.60	1.640.1300.60	1.660.1300.60
PG 13,5	5–9	10	24	22	1.610.1300.61	1.640.1300.61	1.660.1300.61
PG 16	10–14	10	23	24	1.610.1600.60	1.640.1600.60	1.660.1600.60
PG 16	7–12	10	23	24	1.610.1600.61	1.640.1600.61	1.660.1600.61
PG 21	14–18	12	24	30	1.610.2100.60	1.640.2100.60	1.660.2100.60
PG 21	10–16	12	24	30	1.610.2100.61	1.640.2100.61	1.660.2100.61
PG 29	20–25	12	29	40	1.610.2900.60	1.640.2900.60	1.660.2900.60
PG 29	13–20	12	29	40	1.610.2900.61	1.640.2900.61	1.660.2900.61
PG 36	22–32	15	35	50	1.610.3600.60	1.640.3600.60	1.660.3600.60
PG 36	20–26	15	35	50	1.610.3600.61	1.640.3600.61	1.660.3600.61
PG 42	32–38	15	37	57	1.610.4200.60	1.640.4200.60	1.660.4200.60
PG 42	25–31	15	37	57	1.610.4200.61	1.640.4200.61	1.660.4200.61
PG 48	37–44	15	38	64	1.610.4800.60	1.640.4800.60	1.660.4800.60
PG 48	29–35	15	38	64	1.610.4800.61	1.640.4800.61	1.660.4800.61

Ex e METAL CABLE GLANDS

HSK-M-Multi-Ex

Metr., PG, NPT



Material	Nickel plated brass
Clamping insert	Polyamide
Seal	Elastomer
O-Ring	Buna-N
Protection	IP 68
Operating Temperature	-20 °C – 95 °C (-4 °F – 203 °F)

- // INOX upon request
- // The inserts shown are samples, more inserts upon request

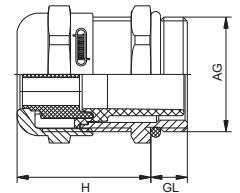

AG	GL mm	H mm	⌀ mm	Number of holes x d	Number	Number of holes x d	Number
M 16 x 1,5	6	21	17/19	4 x 1,4	1.687.1600.50	2 x 3	1.687.1601.50
M 20 x 1,5	6	23	22	6 x 3	1.687.2001.50	2 x 5	1.687.2003.50
M 25 x 1,5	7	26	30	4 x 6	1.687.2500.50	3 x 7	1.687.2501.50
M 32 x 1,5	8	31	40	6 x 6,5	1.687.3200.50	4 x 9	1.687.3201.50
M 40 x 1,5	8	37	50	7 x 9	1.687.4001.50	2 x 15	1.687.4003.50
M 50 x 1,5	9	37	57				1.687.5099.50
M 63 x 1,5	10	38	64/68	6 x 12	1.687.6301.50	3 x 18	1.687.6302.50
PG 9	6	21	17	4 x 1,4	1.687.0900.01	2 x 3	1.687.0901.01
PG 11	6	22	20	2 x 4	1.687.1102.01	3 x 3	1.687.1101.01
PG 13,5	6,5	24	22	3 x 4	1.687.1302.01	2 x 5	1.687.1303.01
PG 16	6,5	23	24	4 x 4	1.687.1602.01	6 x 4	1.687.1604.01
PG 16	6,5	23	24	3 x 5,6	1.687.1606.01	2 x 6	1.687.1605.01
PG 21	7	24	30	4 x 6	1.687.2100.01	3 x 7	1.687.2101.01
PG 29	8	29	40	6 x 6,5	1.687.2900.01	4 x 9	1.687.2901.01
PG 36	8	35	50	7 x 9	1.687.3601.01	2 x 15	1.687.3603.01
PG 48	10	38	64	6 x 12	1.687.4801.01	3 x 18	1.687.4802.01
NPT 3/8"	15	21	17/19	4 x 1,4	1.687.3800.70	2 x 3	1.687.3801.70
NPT 1/2"	13	24	24	3 x 4	1.687.1220.70	2 x 5	1.687.1203.70
NPT 3/4"	13	25	30	4 x 6	1.687.3400.70	3 x 7	1.687.3401.70
NPT 1"	19	29	40	6 x 6,5	1.687.1000.70	4 x 9	1.687.1001.70

HSK-M-Flaka-Ex

Metr., PG, NPT



Material	Nickel plated brass
Clamping insert	Polyamide
Seal	Elastomer
O-Ring	Buna-N
Operating Temperature	-20 °C – 95 °C (-4 °F – 203 °F)



II 2G 1D

- // INOX upon request
- // The inserts shown are samples, more inserts upon request

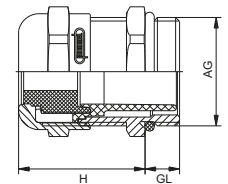

AG	GL mm	H mm	mm	w x h mm	Number	w x h mm	Number
M 20 x 1,5	6	24	24	12 x 7	1.689.2017.50	14 x 6	1.689.2018.50
M 25 x 1,5	7	26	30	14 x 6	1.689.2500.50	14 x 7	1.689.2501.50
M 32 x 1,5	8	31	40	22 x 8	1.689.3200.50		
M 40 x 1,5	8	37	50	28,5 x 10	1.689.4000.50	29 x 5,5	1.689.4001.50
M 40 x 1,5	8	37	50	30,5 x 12	1.689.4002.50	31 x 7,5	1.689.4003.50
M 50 x 1,5	9	37	57	33,5 x 11,5	1.689.5000.50		
M 63 x 1,5	10	38	64/68	38 x 12	1.689.6300.50		
PG 16	6,5	23	24	12 x 7	1.689.1601.01	14 x 6	1.689.1602.01
PG 21	7	24	30	14 x 6	1.689.2100.01	14 x 7	1.689.2101.01
PG 29	8	29	40	22 x 8	1.689.2900.01		
PG 36	8	35	50	28,5 x 10	1.689.3600.01	29 x 5,5	1.689.3601.01
PG 36	8	35	50	30,5 x 12	1.689.3602.01	31 x 7,5	1.689.3603.01
PG 42	9	37	57	33,5 x 11,5	1.689.4200.01		
PG 48	10	38	64	38 x 12	1.689.4802.01		
NPT 3/4"	13	25	30	14 x 6	1.689.3400.70	14 x 7	1.689.3401.70
NPT 1"	19	29	40	22 x 8	1.689.1000.70		

Ex e METAL CABLE GLANDS

HSK-MZ-Ex / HSK-MZ-PVDF-Ex

Metr., PG, NPT



Material	Nickel plated brass
Clamping insert	Polyamide / PVDF
Seal	Buna-N / FKM
O-Ring	Buna-N / FKM
Protection	IP 68 – 10 bar / IP 69K (NEMA 6 – 150 PSIG)
Operating Temperature	-20 °C – 95 °C (-4 °F – 203 °F) -60 °C – 95 °C (-76 °F – 203 °F) / -20 °C – 130 °C (-4 °F – 266 °F) (PVDF)

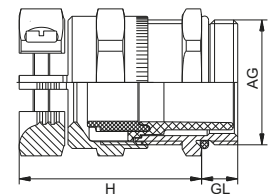

AG mm	∅ mm	GL mm	H mm	HSK-MZ-Ex	Number HSK-MZ-Ex -20 °C – 95 °C	Number HSK-MZ-PVDF-Ex -60 °C – 95 °C	Number -20 °C – 130 °C
M 12 x 1,5	3–6,5	6,5	26	14	1.611.1200.50	1.641.1200.50	1.661.1200.50
M 16 x 1,5	4–8	6	28	19	1.611.1600.50	1.641.1600.50	1.661.1600.50
M 16 x 1,5	6–10	6	30	20	1.611.1611.50	1.641.1611.50	1.661.1611.50
M 20 x 1,5	7–12	6	33	22	1.611.2000.50	1.641.2000.50	1.661.2000.50
M 20 x 1,5	10–14	6	33	24	1.611.2016.50	1.641.2016.50	1.661.2016.50
M 25 x 1,5	14–18	7	37	30	1.611.2500.50	1.641.2500.50	1.661.2500.50
M 32 x 1,5	20–25	8	43	40	1.611.3200.50	1.641.3200.50	1.661.3200.50
M 40 x 1,5	24–32	8	50	50	1.611.4000.50	1.641.4000.50	1.661.4000.50
M 50 x 1,5	32–38	9	51	57	1.611.5000.50	1.641.5000.50	
M 63 x 1,5	37–44	10	52	64 / 68	1.611.6300.50	1.641.6300.50	
PG 7	3–6,5	5	26	14	1.611.0700.01	1.641.0700.01	1.661.0700.01
PG 9	4–8	6	28	17	1.611.0900.01	1.641.0900.01	1.661.0900.01
PG 11	6–10	6	30	20	1.611.1100.01	1.641.1100.01	1.661.1100.01
PG 13,5	7–12	6	33	22	1.611.1300.01	1.641.1300.01	1.661.1300.01
PG 16	10–14	6	33	24	1.611.1600.01	1.641.1600.01	1.661.1600.01
PG 21	13–18	7	37	30	1.611.2100.01	1.641.2100.01	1.661.2100.01
PG 29	20–25	8	43	40	1.611.2900.01	1.641.2900.01	1.661.2900.01
PG 36	24–32	8	50	50	1.611.3600.01	1.641.3600.01	1.661.3600.01
PG 42	32–38	9	51	57	1.611.4200.01	1.641.4200.01	1.661.4200.01
PG 48	37–44	10	52	64	1.611.4800.01	1.641.4800.01	1.661.4800.01
NPT 3/8"	4–8	15	28	17 / 19	1.611.3800.70	1.641.3800.70	1.661.3800.70
NPT 1/2"	7–12	13	33	22 / 24	1.611.1200.70	1.641.1200.70	1.661.1200.70
NPT 3/4"	13–18	13	37	30	1.611.3400.70	1.641.3400.70	1.661.3400.70
NPT 1"	20–25	19	43	40	1.611.1000.70	1.641.1000.70	

HSK-INOX-Ex / HSK-INOX-PVDF-Ex

Metr., PG



Material	INOX 1.4305
Clamping insert	Polyamid / PVDF
Seal	NBR / FKM
O-Ring	NBR / FKM
Protection	IP 68 – 10 bar / IP 69K
Operating Temperature	-20 °C – 95 °C (-4 °F – 203 °F) -60 °C – 95 °C (-76 °F – 203 °F) / -20 °C – 130 °C (-4 °F – 266 °F) (PVDF)

// INOX 1.4404 upon request

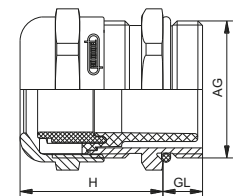

AG	∅ _k mm	GL mm	H mm	 mm	Number HSK-INOX-Ex -20 °C – 95 °C	Number HSK-INOX-Ex -60 °C – 95 °C	Number HSK-INOX-PVDF-Ex -20 °C – 130 °C
M 12 x 1,5	3–6,5	6,5	19	14	1.612.1200.50	1.642.1200.50	1.662.1200.50
M 12 x 1,5	2–5	6,5	19	14	1.612.1200.51	1.642.1200.51	1.662.1200.51
M 16 x 1,5	5–10	6	22	22	1.612.1600.50	1.642.1600.50	1.662.1600.50
M 16 x 1,5	3–7	6	22	22	1.612.1600.51	1.642.1600.51	1.662.1600.51
M 20 x 1,5	10–14	6	23	24	1.612.2000.50	1.642.2000.50	1.662.2000.50
M 20 x 1,5	7–12	6	23	24	1.612.2000.51	1.642.2000.51	1.662.2000.51
M 25 x 1,5	13–18	7	24	30	1.612.2500.50	1.642.2500.50	1.662.2500.50
M 25 x 1,5	9–16	7	24	30	1.612.2500.51	1.642.2500.51	1.662.2500.51
M 32 x 1,5	20–25	8	29	41	1.612.3200.50	1.642.3200.50	1.662.3200.50
M 32 x 1,5	13–20	8	29	41	1.612.3200.51	1.642.3200.51	1.662.3200.51
M 40 x 1,5	22–32	8	35	50	1.612.4000.50	1.642.4000.50	1.662.4000.50
M 40 x 1,5	20–26	8	35	50	1.612.4000.51	1.642.4000.51	1.662.4000.51
PG 7	3–6,5	5	19	14	1.612.0700.01	1.642.0700.01	1.662.0700.01
PG 7	2–5	5	19	14	1.612.0700.15	1.642.0700.15	1.662.0700.15
PG 9	4–8	6	21	17	1.612.0900.01	1.642.0900.01	1.662.0900.01
PG 9	2–6	6	21	17	1.612.0900.15	1.642.0900.15	1.662.0900.15
PG 11	5–10	6	22	22	1.612.1100.01	1.642.1100.01	1.662.1100.01
PG 11	3–7	6	22	22	1.612.1100.15	1.642.1100.15	1.662.1100.15
PG 13,5	7–12	6	24	22	1.612.1300.01	1.642.1300.01	1.662.1300.01
PG 13,5	5–9	6	24	22	1.612.1300.15	1.642.1300.15	1.662.1300.15
PG 16	10–14	6	23	24	1.612.1600.01	1.642.1600.01	1.662.1600.01
PG 16	7–12	6	23	24	1.612.1600.15	1.642.1600.15	1.662.1600.15
PG 21	13–18	7	24	30	1.612.2100.01	1.642.2100.01	1.662.2100.01
PG 21	9–16	7	24	30	1.612.2100.15	1.642.2100.15	1.662.2100.15
PG 29	20–25	8	29	41	1.612.2900.01	1.642.2900.01	1.662.2900.01
PG 29	13–20	8	29	41	1.612.2900.15	1.642.2900.15	1.662.2900.15
PG 36	22–32	8	35	50	1.612.3600.01	1.642.3600.01	1.662.3600.01
PG 36	20–26	8	35	50	1.612.3600.15	1.642.3600.15	1.662.3600.15

Plastic
Metal
EMC
Special applications, DIN
Accessories
Ex
EMC-Ex
Ex Accessories
EXIOS

Ex d METAL CABLE GLANDS

HSK-M-Ex d / HSK-M-PVDF-Ex d Metr.



Material	Nickel plated brass
Clamping insert	Polyamide / PVDF
Seal / O-Ring	FKM
Protection	IP 68 – 10 bar / IP 69K (NEMA 6 – 150 PSIG)
Operating Temperature	-60 °C – 105 °C (-76 °F – 221 °F) (PA) -20 °C – 130 °C (-4 °F – 266 °F) (PVDF)



II 2G 1D Ex d IIC

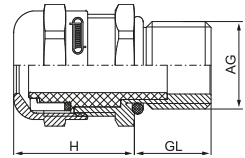

AG	\varnothing mm	GL mm	H mm	\varnothing mm	Number HSK-M-Ex d -60 °C – 105 °C	Number HSK-M-PVDF-Ex d -20 °C – 130 °C
M 12 x 1,5	3–6,5	16	18,7	14	1.622.1200.50	1.634.1200.50
M 12 x 1,5	2–5	16	18,7	14	1.622.1200.51	1.634.1200.51
M 16 x 1,5	5–10	16	22	20	1.622.1600.50	1.634.1600.50
M 16 x 1,5	3–7	16	22	20	1.622.1600.51	1.634.1600.51
M 20 x 1,5	10–14	16	25	24	1.622.2000.50	1.634.2000.50
M 20 x 1,5	7–12	16	25	24	1.622.2000.51	1.634.2000.51
M 25 x 1,5	13–18	16	26,5	30	1.622.2500.50	1.634.2500.50
M 25 x 1,5	9–16	16	26,5	30	1.622.2500.51	1.634.2500.51
M 32 x 1,5	18–25	16	32	40	1.622.3200.50	1.634.3200.50
M 32 x 1,5	14–20	16	32	40	1.622.3200.51	1.634.3200.51
M 40 x 1,5	22–32	16	38,5	50	1.622.4000.50	1.634.4000.50
M 40 x 1,5	20–26	16	38,5	50	1.622.4000.51	1.634.4000.51

HSK-M-Ex d / HSK-M-PVDF-Ex d NPT



Material	Nickel plated brass
Clamping insert	Polyamide / PVDF
Seal	FKM
Protection	IP 68 – 10 bar / IP 69K (NEMA 6 – 150 PSIG)
Operating Temperature	-60 °C – 105 °C (-76 °F – 221 °F) (PA) -20 °C – 130 °C (-4 °F – 266 °F) (PVDF)



II 2G 1D Ex d IIC

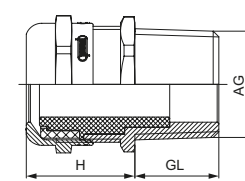

AG	\varnothing mm	GL mm	H mm	\varnothing mm	Number HSK-M-Ex d -60 °C – 105 °C	Number HSK-M-PVDF-Ex d -20 °C – 130 °C
NPT 3/8"	5–10	16	22	20	1.622.3800.70	1.634.3800.70
NPT 3/8"	3–7	16	22	20	1.622.3800.71	1.634.3800.71
NPT 1/2"	10–14	20	25	24	1.622.1200.70	1.634.1200.70
NPT 1/2"	7–12	20	25	24	1.622.1200.71	1.634.1200.71
NPT 3/4"	13–18	20,5	26,5	30	1.622.3400.70	1.634.3400.70
NPT 3/4"	9–16	20,5	26,5	30	1.622.3400.71	1.634.3400.71
NPT 1"	18–25	25	32	40	1.622.1000.70	1.634.1000.70
NPT 1"	14–20	25	32	40	1.622.1000.71	1.634.1000.71
NPT 1 1/4"	22–32	26	38,5	50	1.622.5400.70	1.634.5400.70
NPT 1 1/4"	20–26	26	38,5	50	1.622.5400.71	1.634.5400.71
NPT 1 1/2"	22–32	26,5	38,5	50	1.622.6400.70	1.634.6400.70
NPT 1 1/2"	20–26	26,5	38,5	50	1.622.6400.71	1.634.6400.71

HSK-MZ-Ex d

Metr.



Material	Nickel plated brass
Clamping insert	Polyamide
Seal / O-Ring	FKM
Protection	IP 68 – 10 bar / IP 69K (NEMA 6 – 150 PSIG)
Operating Temperature	-60 °C – 105 °C (-76 °F – 221 °F)

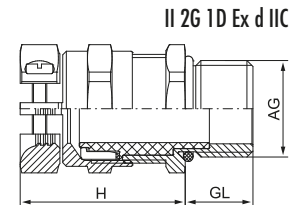

AG	\varnothing mm	GL mm	H mm	\varnothing mm	Number HSK-MZ-Ex d -60 °C – 105 °C
M 12 x 1,5	3–6,5	16	26	14	1.628.1200.50
M 16 x 1,5	5–10	16	30,2	20	1.628.1600.50
M 20 x 1,5	10–14	16	34	24	1.628.2000.50
M 25 x 1,5	13–18	16	37,8	30	1.628.2500.50
M 32 x 1,5	18–25	16	44	40	1.628.3200.50
M 40 x 1,5	22–32	16	51,5	50	1.628.4000.50

HSK-MZ-Ex d

NPT



Material	Nickel plated brass
Clamping insert	Polyamide
Seal	FKM
Protection	IP 68 – 10 bar / IP 69K (NEMA 6 – 150 PSIG)
Operating Temperature	-60 °C – 105 °C (-76 °F – 221 °F)

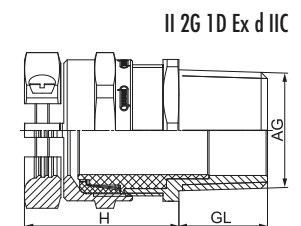

AG	\varnothing mm	GL mm	H mm	\varnothing mm	Number HSK-MZ-Ex d -60 °C – 105 °C
NPT 3/8"	5–10	16	30	20	1.628.3800.70
NPT 1/2"	10–14	20	33,6	24	1.628.1200.70
NPT 3/4"	13–18	20,5	37,8	30	1.628.3400.70
NPT 1"	18–25	25	44	40	1.628.1000.70
NPT 1 1/4"	22–32	26	51,5	50	1.628.5400.70
NPT 1 1/2"	22–32	26,5	51,5	50	1.628.6400.70

Ex d METAL CABLE GLANDS

HSK-INOX-Ex d / HSK-INOX-PVDF-Ex d

Metr.



Material	INOX 1.4404
Clamping insert	Polyamide / PVDF
Seal / O-Ring	FKM
Protection	IP 68 – 10 bar / IP 69K (NEMA 6 – 150 PSIG)
Operating Temperature	-60 °C – 105 °C (-76 °F – 221 °F) (PA) -20 °C – 130 °C (-4 °F – 266 °F) (PVDF)



II 2G 1D Ex d IIC

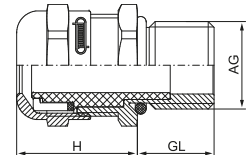

AG	\varnothing mm	GL mm	H mm	\varnothing mm	Number HSK-INOX-Ex d -60 °C – 105 °C	Number HSK-INOX-PVDF-Ex d -20 °C – 130 °C
M 12 x 1,5	3–6,5	16	19	14	1.632.1200.50	1.633.1200.50
M 12 x 1,5	2–5	16	19	14	1.632.1200.51	1.633.1200.51
M 16 x 1,5	5–10	16	22	20	1.632.1600.50	1.633.1600.50
M 16 x 1,5	3–7	16	22	20	1.632.1600.51	1.633.1600.51
M 20 x 1,5	10–14	16	25	24	1.632.2000.50	1.633.2000.50
M 20 x 1,5	7–12	16	25	24	1.632.2000.51	1.633.2000.51
M 25 x 1,5	13–18	16	26,5	30	1.632.2500.50	1.633.2500.50
M 25 x 1,5	9–16	16	26,5	30	1.632.2500.51	1.633.2500.51
M 32 x 1,5	18–25	16	32	40	1.632.3200.50	1.633.3200.50
M 32 x 1,5	14–20	16	32	40	1.632.3200.51	1.633.3200.51
M 40 x 1,5	22–32	16	38,5	50	1.632.4000.50	1.633.4000.50
M 40 x 1,5	20–26	16	38,5	50	1.632.4000.51	1.633.4000.51

HSK-INOX-Ex d / HSK-INOX-PVDF-Ex d

NPT



Material	INOX 1.4404
Clamping insert	Polyamide / PVDF
Seal	FKM
Protection	IP 68 – 10 bar / IP 69K (NEMA 6 – 150 PSIG)
Operating Temperature	-60 °C – 105 °C (-76 °F – 221 °F) (PA) -20 °C – 130 °C (-4 °F – 266 °F) (PVDF)



II 2G 1D Ex d IIC

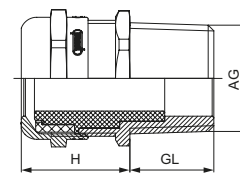

AG	\varnothing mm	GL mm	H mm	\varnothing mm	Number HSK-INOX-Ex d -60 °C – 105 °C	Number HSK-INOX-PVDF-Ex d -20 °C – 130 °C
NPT 3/8"	5–10	16	22	20	1.632.3800.70	1.633.3800.70
NPT 3/8"	3–7	16	22	20	1.632.3800.71	1.633.3800.71
NPT 1/2"	10–14	20	25	24	1.632.1200.70	1.633.1200.70
NPT 1/2"	7–12	20	25	24	1.632.1200.71	1.633.1200.71
NPT 3/4"	13–18	20,5	26,5	30	1.632.3400.70	1.633.3400.70
NPT 3/4"	9–16	20,5	26,5	30	1.632.3400.71	1.633.3400.71

EMC-Ex e CABLE GLANDS



Safe EMC protection plus explosion area approval: This is what EMC Ex e cable glands deliver. HUMMEL also offers a range of designs for particular requirements here too. These include cable glands for high-temperature applications, designs for very easy fitting and also stainless steel versions.

In this chapter, you will find:

- // HSK-M-EMC-Ex: Cable glands with excellent shielding properties
- // HSK-M-EMC-D-Ex: Fast, easy fitting, combined with maximum EMC protection
- // HSK-M-PVDF-EMC-Ex: High-temperature cable glands with EMC connection and explosion protection
- // HSK-INOX-EMC-Ex: Stainless steel cable glands
- // HSK-MZ-EMC-Ex: Glands with a high level of tension-relief, EMC and explosion protection

HUMMEL has many years of experience in handling components for explosion-protection areas. This is why we have a sophisticated range of explosion area products in a range of materials and designs.

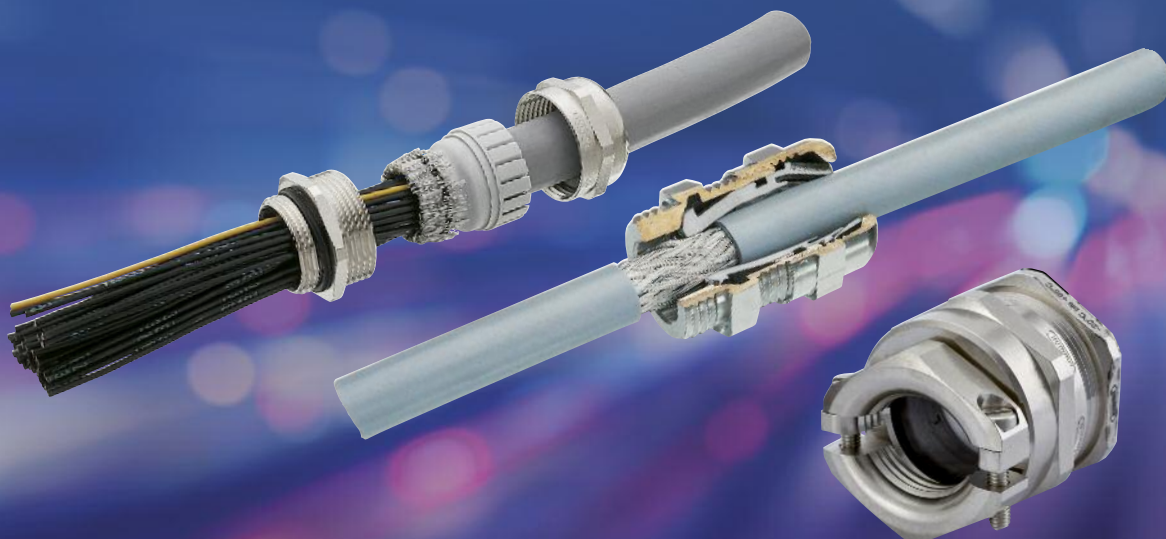

EMC-Ex e CABLE GLANDS

HSK-M-EMC-D-Ex Metr.



Material	Nickel plated brass
Clamping insert	Metallized Polyamide
Seal / O-Ring	Buna-N
Protection	IP 68 – 10 bar / IP 69K (NEMA 6 – 150 PSIG)
Operating Temperature	-20 °C – 95 °C (-4 °F – 203 °F) -60 °C – 95 °C (-76 °F – 203 °F)

AG	\varnothing mm	GL mm	H mm	\varnothing mm	Number HSK-M-EMC-D-Ex -20 °C – 95 °C	Number HSK-M-EMC-D-Ex -60 °C – 95 °C
M 16 x 1,5	5–10	6	29	20	1.636.1600.50	1.637.1600.50
M 20 x 1,5	10–14	6	31	24	1.636.2000.50	1.637.2000.50
M 25 x 1,5	13–18	7	38	30	1.636.2500.50	1.637.2500.50
M 32 x 1,5	18–25	8	43	40	1.636.3200.50	1.637.3200.50
M 40 x 1,5	24–32	8	51	50	1.636.4000.50	1.637.4000.50

HSK-M-EMC-D-Ex Metr.-elongated



Material	Nickel plated brass
Clamping insert	Metallized Polyamide
Seal / O-Ring	Buna-N
Protection	IP 68 – 10 bar / IP 69K (NEMA 6 – 150 PSIG)
Operating Temperature	-20 °C – 95 °C (-4 °F – 203 °F) -60 °C – 95 °C (-76 °F – 203 °F)

AG	\varnothing mm	GL mm	H mm	\varnothing mm	Number HSK-M-EMC-D-Ex -20 °C – 95 °C	Number HSK-M-EMC-D-Ex -60 °C – 95 °C
M 16 x 1,5	5–10	10	29	20	1.636.1600.30	1.637.1600.30
M 20 x 1,5	10–14	10	31	24	1.636.2000.30	1.637.2000.30
M 25 x 1,5	13–18	12	38	30	1.636.2500.30	1.637.2500.30
M 32 x 1,5	18–25	12	43	40	1.636.3200.30	1.637.3200.30
M 40 x 1,5	24–32	15	51	50	1.636.4000.30	1.637.4000.30

HSK-M-EMC-D-Ex

PG



Material	Nickel plated brass
Clamping insert	Metallized Polyamide
Seal	Buna-N
O-Ring	NBR
Protection	IP 68 – 10 bar / IP 69K (NEMA 6 – 150 PSIG)
Operating Temperature	-20 °C – 95 °C (-4 °F – 203 °F) -60 °C – 95 °C (-76 °F – 203 °F)

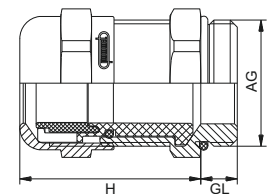

AG	\varnothing mm	GL mm	H mm	\varnothing mm	Number HSK-M-EMC-D-Ex -20 °C – 95 °C	Number HSK-M-EMC-D-Ex -60 °C – 95 °C
PG 11	5–10	6	29	20	1.636.1100.01	1.637.1100.01
PG 13,5	7–12	6,5	31	22	1.636.1300.01	1.637.1300.01
PG 16	10–14	6,5	32	24	1.636.1600.01	1.637.1600.01
PG 21	13–18	7	38	30	1.636.2100.01	1.637.2100.01
PG 29	18–25	8	43	40	1.636.2900.01	1.637.2900.01
PG 36	22–32	8	48	50	1.636.3600.01	1.637.3600.01

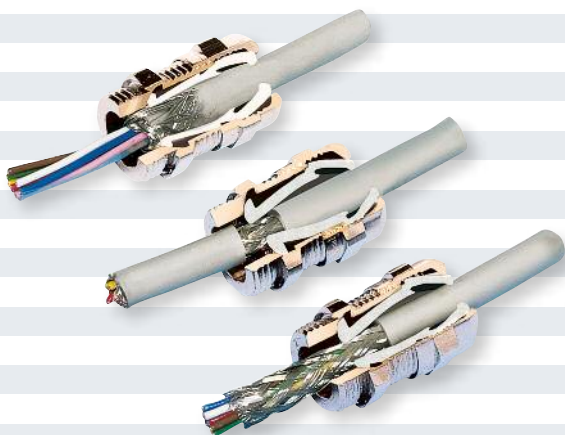

EMC-Ex e CABLE GLANDS

HSK-M-EMC-Ex Metr.



Material	Nickel plated brass
Clamping insert	Polyamide
Seal	Buna-N
O-Ring	Buna-N
Protection	IP 68 – 10 bar / IP 69K (NEMA 6 – 150 PSIG)
Operating Temperature	-20 °C – 95 °C (-4 °F – 203 °F) -60 °C – 95 °C (-76 °F – 203 °F)

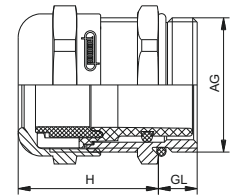

AG	\varnothing mm	GL mm	H mm	\varnothing mm	Number HSK-M-EMC-Ex -20 °C – 95 °C	Number HSK-M-EMC-Ex -60 °C – 95 °C
M 12 x 1,5	3–6,5	6,5	19	14	1.616.1200.50	1.646.1200.50
M 12 x 1,5	2–5	6,5	19	14	1.616.1200.51	1.646.1200.51
M 16 x 1,5	6–10	6	22	20	1.616.1600.50	1.646.1600.50
M 16 x 1,5	3–7	6	22	20	1.616.1600.51	1.646.1600.51
M 20 x 1,5	10–14	6	23	24	1.616.2000.50	1.646.2000.50
M 20 x 1,5	7–12	6	23	24	1.616.2000.51	1.646.2000.51
M 25 x 1,5	14–18	7	24	30	1.616.2500.50	1.646.2500.50
M 25 x 1,5	10–16	7	24	30	1.616.2500.51	1.646.2500.51
M 32 x 1,5	20–25	8	31	40	1.616.3200.50	1.646.3200.50
M 32 x 1,5	13–20	8	31	40	1.616.3200.51	1.646.3200.51
M 40 x 1,5	22–32	8	37	50	1.616.4000.50	1.646.4000.50
M 40 x 1,5	20–26	8	37	50	1.616.4000.51	1.646.4000.51
M 50 x 1,5	32–38	9	37	57	1.616.5000.50	1.646.5000.50
M 50 x 1,5	25–31	9	37	57	1.616.5000.51	1.646.5000.51
M 63 x 1,5	37–44	10	38	64/68	1.616.6300.50	1.646.6300.50
M 63 x 1,5	29–35	10	38	64/68	1.616.6300.51	1.646.6300.51

HSK-M-EMC-Ex / HSK-M-EMC-PVDF-Ex

PG, NPT



Material	Nickel plated brass
Clamping insert	Polyamide / PVDF
Seal	Buna-N / FKM
O-Ring	Buna-N / FKM
Protection	IP 68 – 10 bar / IP 69K (NEMA 6 – 150 PSIG)
Operating Temperature	-20 °C – 95 °C (-4 °F – 203 °F) -60 °C – 95 °C (-76 °F – 203 °F) / -20 °C – 130 °C (-4 °F – 266 °F) (PVDF)

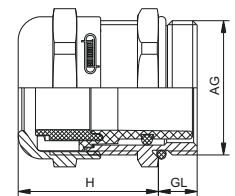

AG	∅ _k mm	GL mm	H mm	⌀ mm	Number HSK-M-EMC-Ex -20 °C – 95 °C	Number HSK-M-EMC-Ex -60 °C – 95 °C	Number HSK-M-PVDF-EMC-Ex -20 °C – 130 °C
PG 7	3–6,5	5	19	14	1.616.0700.01	1.646.0700.01	1.666.0700.01
PG 7	2–5	5	19	14	1.616.0700.15	1.646.0700.15	1.666.0700.15
PG 9	4–8	6	21	17	1.616.0900.01	1.646.0900.01	1.666.0900.01
PG 9	2–6	6	21	17	1.616.0900.15	1.646.0900.15	1.666.0900.15
PG 11	6–10	6	22	20	1.616.1100.01	1.646.1100.01	1.666.1100.01
PG 11	3–7	6	22	20	1.616.1100.15	1.646.1100.15	1.666.1100.15
PG 13,5	7–12	6,5	24	22	1.616.1300.01	1.646.1300.01	1.666.1300.01
PG 13,5	5–9	6,5	24	22	1.616.1300.15	1.646.1300.15	1.666.1300.15
PG 16	10–14	6,5	23	24	1.616.1600.01	1.646.1600.01	1.666.1600.01
PG 16	7–12	6,5	23	24	1.616.1600.15	1.646.1600.15	1.666.1600.15
PG 21	14–18	7	24	30	1.616.2100.01	1.646.2100.01	1.666.2100.01
PG 21	10–16	7	24	30	1.616.2100.15	1.646.2100.15	1.666.2100.15
PG 29	20–25	8	29	40	1.616.2900.01	1.646.2900.01	1.666.2900.01
PG 29	13–20	8	29	40	1.616.2900.15	1.646.2900.15	1.666.2900.15
PG 36	22–32	8	35	50	1.616.3600.01	1.646.3600.01	1.666.3600.01
PG 36	20–26	8	35	50	1.616.3600.15	1.646.3600.15	1.666.3600.15
PG 42	32–38	9	37	57	1.616.4200.01	1.646.4200.01	1.666.4200.01
PG 42	25–31	9	37	57	1.616.4200.15	1.646.4200.15	1.666.4200.15
PG 48	37–44	10	38	64	1.616.4800.01	1.646.4800.01	1.666.4800.01
PG 48	29–35	10	38	64	1.616.4800.15	1.646.4800.15	1.666.4800.15
NPT 3/8"	4–8	15	21	17/19	1.616.3800.70	1.646.3800.70	1.666.3800.70
NPT 3/8"	2–6	15	21	17/19	1.616.3800.71	1.646.3800.71	1.666.3800.71
NPT 1/2"	7–12	13	24	22/24	1.616.1200.70	1.646.1200.70	1.666.1200.70
NPT 1/2"	5–9	13	24	22/24	1.616.1200.71	1.646.1200.71	1.666.1200.71
NPT 3/4"	14–18	13	25	30	1.616.3400.70	1.646.3400.70	1.666.3400.70
NPT 3/4"	10–16	13	25	30	1.616.3400.71	1.646.3400.71	1.666.3400.71

EMC-Ex e CABLE GLANDS

HSK-MZ-EMC-Ex Metr.



Material	Nickel plated brass
Clamping insert	Polyamide
Seal	Buna-N
O-Ring	Buna-N
Protection	IP 68 – 10 bar / IP 69K (NEMA 6 – 150 PSIG)
Operating Temperature	-20 °C – 95 °C (-4 °F – 203 °F) -60 °C – 95 °C (-76 °F – 203 °F)

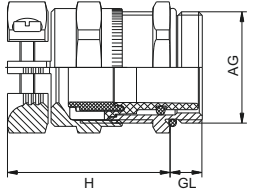

AG	\varnothing mm	GL mm	H mm	 mm	Number HSK-M-EMC-Ex -20 °C – 95 °C	Number HSK-M-EMC-Ex -60 °C – 95 °C
M 12 x 1,5	3–6,5	6,5	26	14	1.617.1200.50	1.647.1200.50
M 16 x 1,5	6–10	6	29	20	1.617.1600.50	1.647.1600.50
M 20 x 1,5	10–14	6	32	24	1.617.2000.50	1.647.2000.50
M 25 x 1,5	14–18	7	35	30	1.617.2500.50	1.647.2500.50
M 32 x 1,5	20–25	8	41	40	1.617.3200.50	1.647.3200.50
M 40 x 1,5	24–32	8	48	50	1.617.4000.50	1.647.4000.50
M 50 x 1,5	32–38	9	51	57	1.617.5000.50	1.647.5000.50
M 50 x 1,5	28–31	9	51	57	1.617.5000.51	1.647.5000.51
M 63 x 1,5	37–44	10	52	68	1.617.6300.50	1.647.6300.50
M 63 x 1,5	32–35	10	52	68	1.617.6300.51	1.647.6300.51



HSK-MZ-EMC-Ex / HSK-MZ-EMC-PVDF-Ex

PG, NPT



Material	Nickel plated brass
Clamping insert	Polyamide / PVDF
Seal	Buna-N
O-Ring	Buna-N
Protection	IP 68 – 10 bar / IP 69K (NEMA 6 – 150 PSIG)
Operating Temperature	-20 °C – 95 °C (-4 °F – 203 °F) -60 °C – 95 °C (-76 °F – 203 °F)

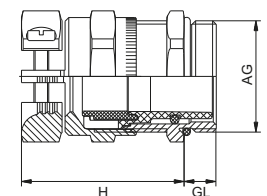

AG	Ø mm	GL mm	H mm	Ø mm	Number		
					HSK-MZ-EMC-Ex -20 °C – 95 °C	HSK-MZ-EMC-Ex -60 °C – 95 °C	HSK-MZ-PVDF-EMC-Ex -20 °C – 130 °C
PG 7	3–6,5	5	26	14	1.617.0700.01	1.647.0700.01	1.667.0700.01
PG 9	4–8	6	28	17	1.617.0900.01	1.647.0900.01	1.667.0900.01
PG 11	6–10	6	29	20	1.617.1100.01	1.647.1100.01	1.667.1100.01
PG 13,5	7–12	6,5	33	22	1.617.1300.01	1.647.1300.01	1.667.1300.01
PG 16	10–14	6,5	32	24	1.617.1600.01	1.647.1600.01	1.667.1600.01
PG 21	13–18	7	35	30	1.617.2100.01	1.647.2100.01	1.667.2100.01
PG 29	20–25	8	41	40	1.617.2900.01	1.647.2900.01	1.667.2900.01
PG 36	24–32	8	48	50	1.617.3600.01	1.647.3600.01	1.667.3600.01
PG 42	32–38	9	51	57	1.617.4200.01	1.647.4200.01	1.667.4200.01
PG 42	28–31	9	51	57	1.617.4200.15	1.647.4200.15	1.667.4200.15
PG 48	37–44	10	51	64	1.617.4800.01	1.647.4800.01	1.667.4800.01
PG 48	32–35	10	51	64	1.617.4800.15	1.647.4800.15	1.667.4800.15
NPT 3/8"	4–8	15	27	17/19	1.617.3800.70	1.647.3800.70	1.667.3800.70
NPT 1/2"	7–12	13	31	22/24	1.617.1200.70	1.647.1200.70	1.667.1200.70
NPT 3/4"	13–18	13	36	30	1.617.3400.70	1.647.3400.70	1.667.3400.70

Plastic
Metal
EMC
Special applications, DIN
Accessories
Ex
EMC-Ex
Ex Accessories
EXIOS

HSK-INOX-EMC-Ex

Metr.



Material	INOX 1.4305
Clamping insert	Polyamide
Seal	Buna-N
O-Ring	Buna-N
Protection	IP 68 – 10 bar / IP 69K (NEMA 6 – 150 PSIG)
Operating Temperature	-60 °C – 95 °C (-76 °F – 203 °F)

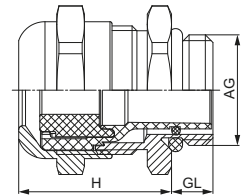

AG	Øk mm	GL mm	H mm	ØR mm	Number
M 12 x 1,5	3–6,5	6,5	19	14	1.673.1200.50
M 12 x 1,5	2–5	6,5	19	14	1.673.1200.51
M 16 x 1,5	5–10	6	21	20	1.673.1600.50
M 16 x 1,5	3–7	6	21	20	1.673.1600.51
M 20 x 1,5	10–14	6	23	24	1.673.2000.50
M 20 x 1,5	7–12	6	23	24	1.673.2000.51
M 25 x 1,5	13–18	7	26	30	1.673.2500.50
M 25 x 1,5	9–16	7	26	30	1.673.2500.51
M 32 x 1,5	18–25	8	31	41	1.673.3200.50
M 32 x 1,5	13–20	8	31	41	1.673.3200.51
M 40 x 1,5	22–32	8	37	50	1.673.4000.50
M 40 x 1,5	20–26	8	37	50	1.673.4000.51
PG 7	3–6,5	5	19	14	1.673.0700.01
PG 7	2–5	5	19	14	1.673.0700.15
PG 9	4–8	6	21	17	1.673.0900.01
PG 9	2–6	6	21	17	1.673.0900.15
PG 11	5–10	6	22	22	1.673.1100.01
PG 11	3–7	6	22	22	1.673.1100.15
PG 13,5	7–12	6,5	24	22	1.673.1300.01
PG 13,5	5–9	6,5	24	22	1.673.1300.15
PG 16	10–14	6,5	23	24	1.673.1600.01
PG 16	7–12	6,5	23	24	1.673.1600.15
PG 21	13–18	7	24	30	1.673.2100.01
PG 21	9–16	7	24	30	1.673.2100.15
PG 29	18–25	8	29	41	1.673.2900.01
PG 29	13–20	8	29	41	1.673.2900.15
PG 36	22–32	8	35	50	1.673.3600.01
PG 36	20–26	8	35	50	1.673.3600.15

Ex ACCESSORIES



Cable glands for explosion protection areas also demand accessories specifically designed for those areas. HUMMEL has a wide range of accessories specially developed for this sector. These accessories meet all the requirements for ex-areas and are backed up by all the necessary certification and approvals.

In this chapter, you will find:

- // Accessories in plastic, brass and stainless steel
- // Plugs with explosion area approval
- // Reduction fittings in a wide range of different sizes

The accessories come in a range of materials, sizes and thread types.



Plug V-Ex Metr.



Material	Polyamide, fiber reinforced
O-Ring	Buna-N
Protection	IP 68 – 10 bar / IP 69K (NEMA 6 – 150 PSIG)
Operating Temperature	-20 °C – 95 °C (-4 °F – 203 °F)
Colors	black (RAL 9005)

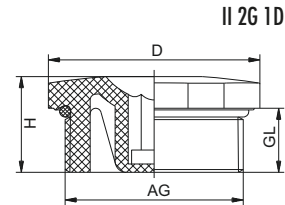

AG	GL mm	H mm	D mm			Number
M 12 x 1,5	8,5	13	16,5	15	6	1.297.1201.50
M 16 x 1,5	8,5	13	20,5	19	8	1.297.1601.50
M 20 x 1,5	9	14,5	25,5	24	8	1.297.2001.50
M 25 x 1,5	10,5	16	30,5	28	8	1.297.2501.50
M 32 x 1,5	11,5	17,5	38	36	8	1.297.3201.50
M 40 x 1,5	11,5	18	48	46	8	1.297.4001.50
M 50 x 1,5	13,5	20	60	55	8	1.297.5001.50
M 63 x 1,5	14,5	21	75	70	8	1.297.6301.50

Plug V-Ex PG

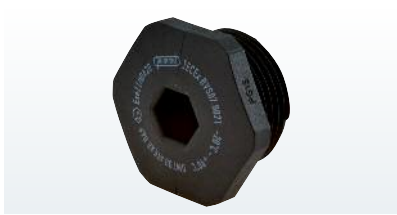

Material	Polyamide, fiber reinforced
O-Ring	Buna-N
Protection	IP 68 – 10 bar / IP 69K (NEMA 6 – 150 PSIG)
Operating Temperature	-20 °C – 95 °C (-4 °F – 203 °F)
Colors	black (RAL 9005)

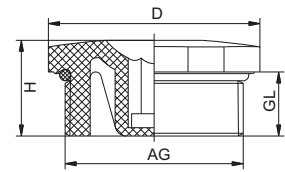

AG	GL mm	H mm	D mm			Number
PG 7	8,5	13	16,5	15	6	1.297.0701.11
PG 9	8,5	13	20,5	19	8	1.297.0901.11
PG 11	9	14,5	25,5	24	8	1.297.1101.11
PG 13,5	9	14,5	25,5	24	8	1.297.1301.11
PG 16	10,5	16	30,5	28	8	1.297.1601.11
PG 21	11,5	17,5	38	36	8	1.297.2101.11
PG 29	11,5	18	48	46	8	1.297.2901.11
PG 36	13,5	20	60	55	8	1.297.3601.11
PG 42	13,5	20	65	60	8	1.297.4201.11
PG 48	14,5	21	75	70	8	1.297.4801.11

Plug HSK-V-Ex

Metr., PG, NPT



Material	Elastomer
Operating Temperature	-40 °C – 95 °C (-40 °F – 203 °F)
Colors	black (RAL 9005)

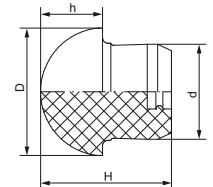

Fits the following sizes			D mm	d mm	H mm	h mm	Number
PG 7	M 12 x 1,5		9,5	6,3	11,5	4,5	1.296.0701.11
PG 9	M 16 x 1,5	NPT 3/8"	11	7,8	13,5	5,5	1.296.0901.11
PG 11	M 16 x 1,5		13,5	9,8	14,5	5,5	1.296.1101.11
PG 13,5	M 20 x 1,5	NPT 1/2"	16	11,8	18	8	1.296.1301.11
PG 16	M 20 x 1,5	NPT 1/2"/16	18,5	13,8	19	9	1.296.1601.11
PG 21	M 25 x 1,5	NPT 3/4"	22	17,8	22	11	1.296.2101.11
PG 29	M 32 x 1,5	NPT 1" NPT 1 1/4"	29	25	25	10	1.296.2901.11
PG 36	M 40 x 1,5	NPT 1 1/2"	38	32	28	11	1.296.3601.11
PG 42	M 50 x 1,5		43	38	30	12	1.296.4201.11
PG 48	M 63 x 1,5		49	44	30	12	1.296.4801.11

Plug HSK-V-Ex MZ version

Metr., PG, NPT



Material	Elastomer
Operating Temperature	-40 °C – 95 °C (-40 °F – 203 °F)
Colors	black (RAL 9005)

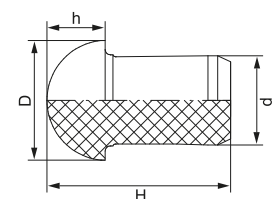

// This plug is suitable in all HSK glands with additional strain relief

Fits the following sizes			D mm	d mm	H mm	h mm	Number
PG 7	M 12 x 1,5		9,5	6,3	18	4,5	1.296.0701.61
PG 9	M 16 x 1,5	NPT 3/8"	11	7,8	20,5	5,5	1.296.0901.61
PG 11	M 16 x 1,5		13,5	9,8	22	5,5	1.296.1101.61
PG 13,5	M 20 x 1,5	NPT 1/2"	16	11,8	26,5	8	1.296.1301.61
PG 16	M 20 x 1,5	NPT 1/2"/16	18,5	13,8	28,4	9	1.296.1601.61
PG 21	M 25 x 1,5	NPT 3/4"	22	17,8	32	11	1.296.2101.61
PG 29	M 32 x 1,5	NPT 1" NPT 1 1/4"	29	25	35,5	10	1.296.2901.61
PG 36	M 40 x 1,5	NPT 1 1/2"	38	32	39	11	1.296.3601.61

Plug V-Ms-Ex / V-Ms-FKM-Ex / V-Ms-VMQ-Ex Metr.



Material	Nickel plated brass
Protection	IP 68 – 10 bar / IP 69K (NEMA 6 – 150 PSIG)
V-Ms-Ex O-Ring	Buna-N
V-Ms-FKM-Ex O-Ring	FKM
V-Ms-VMQ-Ex O-Ring	VMQ
Operating Temperature	-20 °C – 95 °C (-4 °F – 203 °F) (Buna-N) -20 °C – 180 °C (-4 °F – 356 °F) (FKM) / -60 °C – 180 °C (-76 °F – 356 °F) (VMQ)



II 2G 1D

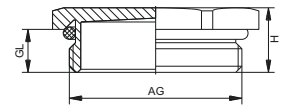

AG	GL mm	H mm		Number V-Ms-Ex -20 °C – 95 °C	Number V-Ms-FKM-Ex -20 °C – 180 °C	Number V-Ms-VMQ-Ex -60 °C – 180 °C
M 12 x 1,5	6,5	9,5	14	1.197.1200.50	1.198.1200.50	1.199.1200.50
M 16 x 1,5	6	9	19	1.197.1600.50	1.198.1600.50	1.199.1600.50
M 20 x 1,5	6	9,5	22	1.197.2000.50	1.198.2000.50	1.199.2000.50
M 25 x 1,5	7	10,5	30	1.197.2500.50	1.198.2500.50	1.199.2500.50
M 32 x 1,5	8	12,5	41	1.197.3200.50	1.198.3200.50	1.199.3200.50
M 40 x 1,5	8	13	46	1.197.4000.50	1.198.4000.50	1.199.4000.50
M 50 x 1,5	9	15	55	1.197.5000.50	1.198.5000.50	1.199.5000.50
M 63 x 1,5	10	16,5	70	1.197.6300.50	1.198.6300.50	1.199.6300.50

Plug V-Ms-Ex / V-Ms-FKM-Ex / V-Ms-VMQ-Ex PG



Material	Nickel plated brass
Protection	IP 68 – 10 bar / IP 69K (NEMA 6 – 150 PSIG)
V-Ms-Ex O-Ring	Buna-N
V-Ms-FKM-Ex O-Ring	FKM
V-Ms-VMQ-Ex O-Ring	VMQ
Operating Temperature	-20 °C – 95 °C (-4 °F – 203 °F) (Buna-N) -20 °C – 180 °C (-4 °F – 356 °F) (FKM) / -60 °C – 180 °C (-76 °F – 356 °F) (VMQ)



II 2G 1D

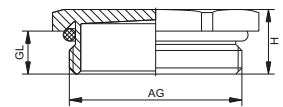

AG	GL mm	H mm		Number V-Ms-Ex -20 °C – 95 °C	Number V-Ms-FKM-Ex -20 °C – 180 °C	Number V-Ms-VMQ-Ex -60 °C – 180 °C
PG 7	5	8	14	1.197.0700.01	1.198.0700.01	1.199.0700.01
PG 9	6	9	17	1.197.0900.01	1.198.0900.01	1.199.0900.01
PG 11	6	9,5	20	1.197.1100.01	1.198.1100.01	1.199.1100.01
PG 13,5	6,5	10	22	1.197.1300.01	1.198.1300.01	1.199.1300.01
PG 16	6,5	10	24	1.197.1600.01	1.198.1600.01	1.199.1600.01
PG 21	7	10,5	30	1.197.2100.01	1.198.2100.01	1.199.2100.01
PG 29	8	12,5	41	1.197.2900.01	1.198.2900.01	1.199.2900.01
PG 36	8	13	50	1.197.3600.01	1.198.3600.01	1.199.3600.01
PG 42	9	15	58	1.197.4200.01	1.198.4200.01	1.199.4200.01
PG 48	10	16,5	65	1.197.4800.01	1.198.4800.01	1.199.4800.01

Adapter RSD-MS-Ex

Metr.



Material	Nickel plated brass
O-Ring	Buna-N / VMQ
Protection	IP 68 – 10 bar / IP 69K (NEMA 6 – 150 PSIG)
Operating Temperature	-20 °C – 95 °C (-4 °F – 203 °F) (Buna-N) -60 °C – 180 °C (-76 °F – 356 °F) (VMQ)

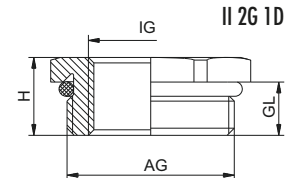

AG	IG	GL mm	H mm	Number NBR -20 °C – 95 °C	Number VMQ -60 °C – 180 °C
M 16 x 1,5	M 12 x 1,5	5	17	1.078.1612.50	1.079.1612.50
M 20 x 1,5	M 12 x 1,5	6	22	1.078.2012.50	1.079.2012.50
M 20 x 1,5	M 16 x 1,5	6	22	1.078.2016.50	1.079.2016.50
M 25 x 1,5	M 16 x 1,5	7	29	1.078.2516.50	1.079.2516.50
M 25 x 1,5	M 20 x 1,5	7	29	1.078.2520.50	1.079.2520.50
M 32 x 1,5	M 16 x 1,5	8	34	1.078.3216.50	1.079.3216.50
M 32 x 1,5	M 20 x 1,5	8	34	1.078.3220.50	1.079.3220.50
M 32 x 1,5	M 25 x 1,5	8	34	1.078.3225.50	1.079.3225.50
M 40 x 1,5	M 20 x 1,5	8	43	1.078.4020.50	1.079.4020.50
M 40 x 1,5	M 25 x 1,5	8	43	1.078.4025.50	1.079.4025.50
M 40 x 1,5	M 32 x 1,5	8	43	1.078.4032.50	1.079.4032.50
M 50 x 1,5	M 25 x 1,5	9	55	1.078.5025.50	1.079.5025.50

AG	IG	GL mm	H mm	Number NBR -20 °C – 95 °C	Number VMQ -60 °C – 180 °C
M 50 x 1,5	M 32 x 1,5	9	55	1.078.5032.50	1.079.5032.50
M 50 x 1,5	M 40 x 1,5	9	55	1.078.5040.50	1.079.5040.50
M 63 x 1,5	M 32 x 1,5	10	65	1.078.6332.50	1.079.6332.50
M 63 x 1,5	M 40 x 1,5	10	65	1.078.6340.50	1.079.6340.50
M 63 x 1,5	M 50 x 1,5	10	65	1.078.6350.50	1.079.6350.50

Adapter RSD-MS-Ex

PG



Material	Nickel plated brass
O-Ring	Buna-N / VMQ
Protection	IP 68 – 10 bar / IP 69K (NEMA 6 – 150 PSIG)
Operating Temperature	-20 °C – 95 °C (-4 °F – 203 °F) (Buna-N) -60 °C – 180 °C (-76 °F – 356 °F) (VMQ)

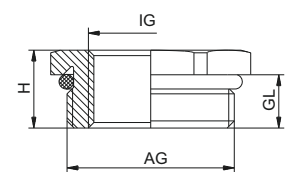

AG	IG	GL mm	H mm	H mm	Number NBR -20 °C – 95 °C	Number VMQ -60 °C – 180 °C
PG 9	PG 7	6	8,8	17	1.078.0907.01	1.079.0907.01
PG 11	PG 7	6	9	20	1.078.1107.01	1.079.1107.01
PG 11	PG 9	6	9	20	1.078.1109.01	1.079.1109.01
PG 13,5	PG 9	6,5	9,5	22	1.078.1309.01	1.079.1309.01
PG 16	PG 9	6,5	9,5	24	1.078.1609.01	1.079.1609.01
PG 16	PG 11	6,5	9,5	24	1.078.1611.01	1.079.1611.01
PG 16	PG 13,5	6,5	9,5	24	1.078.1613.01	1.079.1613.01
PG 21	PG 11	7	10,3	30	1.078.2111.01	1.079.2111.01
PG 21	PG 13,5	7	10,3	30	1.078.2113.01	1.079.2113.01
PG 21	PG 16	7	10,3	30	1.078.2116.01	1.079.2116.01
PG 29	PG 16	8	11,5	40	1.078.2916.01	1.079.2916.01
PG 29	PG 21	8	11,5	40	1.078.2921.01	1.079.2921.01

AG	IG	GL mm	H mm	H mm	Number NBR -20 °C – 95 °C	Number VMQ -60 °C – 180 °C
PG 36	PG 21	9	12,5	50	1.078.3621.01	1.079.3621.01
PG 36	PG 29	9	12,5	50	1.078.3629.01	1.079.3629.01
PG 42	PG 29	10	13,5	57	1.078.4229.01	1.079.4229.01
PG 42	PG 36	10	13,5	57	1.078.4236.01	1.079.4236.01
PG 48	PG 36	10	13,5	64	1.078.4836.01	1.079.4836.01
PG 48	PG 42	10	13,5	64	1.078.4842.01	1.079.4842.01

Plug V-Ms-Ex d Metr., NPT



Material	Nickel plated brass
O-Ring	Buna-N /FKM /VMQ
Protection	IP 68 – 10 bar /IP 69K (NEMA 6 – 150 PSIG)
Operating Temperature	-20 °C – 95 °C (-4 °F – 203 °F) (Buna-N) -20 °C – 180 °C (-4 °F – 356 °F) (FKM) / -60 °C – 180 °C (-76 °F – 356 °F) (VMQ)



II 2G 1D

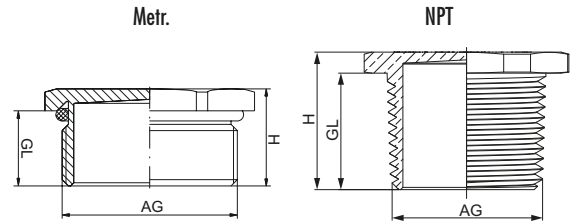

AG	GL mm	H mm	mm	Number without O-Ring	Number Buna-N -20 °C – 95 °C	Number FKM -20 °C – 180 °C	Number VMQ -60 °C – 180 °C
M 12 x 1,5	16	21	14		1.875.1200.50	1.876.1200.50	1.877.1200.50
M 16 x 1,5	16	20	19		1.875.1600.50	1.876.1600.50	1.877.1600.50
M 20 x 1,5	16	19,5	22		1.875.2000.50	1.876.2000.50	1.877.2000.50
M 25 x 1,5	16	19,5	30		1.875.2500.50	1.876.2500.50	1.877.2500.50
M 32 x 1,5	16	20,5	41		1.875.3200.50	1.876.3200.50	1.877.3200.50
M 40 x 1,5	16	21	46		1.875.4000.50	1.876.4000.50	1.877.4000.50
M 50 x 1,5	16	22	55		1.875.5000.50	1.876.5000.50	1.877.5000.50
M 63 x 1,5	16	22,5	70		1.875.6300.50	1.876.6300.50	1.877.6300.50
NPT 3/8"	16	20	16	1.877.3800.70			
NPT 1/2"	20	23,5	24	1.877.1200.70			
NPT 3/4"	20,5	24	30	1.877.3400.70			
NPT 1"	25	29,5	41	1.877.1000.70			
NPT 1 1/4"	26	31	46	1.877.5400.70			
NPT 1 1/2"	26,5	32,5	55	1.877.6400.70			

Adapter RSD-MS-Ex d

Metr.

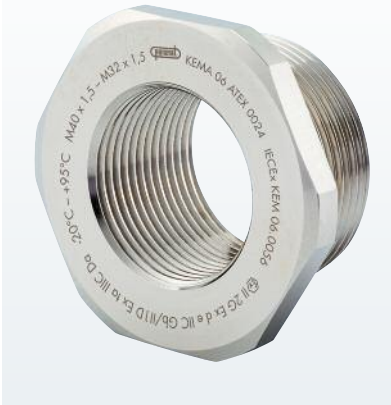

Material	Nickel plated brass
O-Ring	Buna-N / FKM
Protection	IP 68 – 10 bar / IP 69K (NEMA 6 – 150 PSIG)
Operating Temperature	-20 °C – 95 °C (-4 °F – 203 °F) (Buna-N) -60 °C – 180 °C (-76 °F – 356 °F) (VMQ)



II 2G 1D Ex d IIC

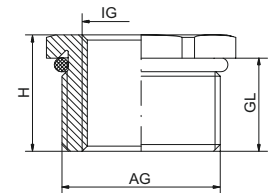

AG	IG	GL mm	H mm	mm	Number Buna-N -20 °C – 95 °C	Number VMQ -60 °C – 180 °C
M 16 x 1,5	M 12 x 1,5	16	19	19	1.878.1612.50	1.879.1612.50
M 20 x 1,5	M 12 x 1,5	16	19,5	22	1.878.2012.50	1.879.2012.50
M 20 x 1,5	M 16 x 1,5	16	19,5	22	1.878.2016.50	1.879.2016.50
M 25 x 1,5	M 16 x 1,5	16	19,5	30	1.878.2516.50	1.879.2516.50
M 25 x 1,5	M 20 x 1,5	16	19,5	30	1.878.2520.50	1.879.2520.50
M 32 x 1,5	M 16 x 1,5	16	20,5	41	1.878.3216.50	1.879.3216.50
M 32 x 1,5	M 20 x 1,5	16	20,5	41	1.878.3220.50	1.879.3220.50
M 32 x 1,5	M 25 x 1,5	16	20,5	41	1.878.3225.50	1.879.3225.50
M 40 x 1,5	M 20 x 1,5	16	21	46	1.878.4020.50	1.879.4020.50
M 40 x 1,5	M 25 x 1,5	16	21	46	1.878.4025.50	1.879.4025.50
M 40 x 1,5	M 32 x 1,5	16	21	46	1.878.4032.50	1.879.4032.50
M 50 x 1,5	M 25 x 1,5	16	21	55	1.878.5025.50	1.879.5025.50
M 50 x 1,5	M 32 x 1,5	16	21	55	1.878.5032.50	1.879.5032.50

Plastic

Metal

EMC

Special applications, DIN

Accessories

Ex

EMC-Ex

Ex Accessories

EXIOS

Plug V-INOX-Ex Metr.



Material	INOX 1.4305
Protection	IP 68 – 10 bar / IP 69K (NEMA 6 – 150 PSIG)
V-INOX-Ex O-Ring	Buna-N
V-INOX-FKM-Ex O-Ring	FKM
V-INOX-VMQ-Ex O-Ring	VMQ
Operating Temperature	-20 °C – 95 °C (-4 °F – 203 °F) (Buna-N) -20 °C – 180 °C (-4 °F – 356 °F) (FKM) / -60 °C – 180 °C (-76 °F – 356 °F) (VMQ)



II 2G 1D

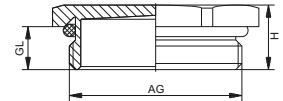

AG	GL mm	H mm	⌀ mm	Number V-INOX-Ex -20 °C – 95 °C	Number V-INOX-FKM-Ex -20 °C – 180 °C	Number V-INOX-VMQ-Ex -60 °C – 180 °C
M 12 x 1,5	6,5	9,5	14	1.192.1200.50	1.193.1200.50	1.194.1200.50
M 16 x 1,5	6	9	19	1.192.1600.50	1.193.1600.50	1.194.1600.50
M 20 x 1,5	6	9,5	22	1.192.2000.50	1.193.2000.50	1.194.2000.50
M 25 x 1,5	7	10,5	30	1.192.2500.50	1.193.2500.50	1.194.2500.50
M 32 x 1,5	8	12,5	41	1.192.3200.50	1.193.3200.50	1.194.3200.50
M 40 x 1,5	8	13	46	1.192.4000.50	1.193.4000.50	1.194.4000.50
M 50 x 1,5	9	15	55	1.192.5000.50	1.193.5000.50	1.194.5000.50
M 63 x 1,5	10	16,5	70	1.192.6300.50	1.193.6300.50	1.194.6300.50

Plug V-INOX-Ex PG



Material	INOX 1.4305
Protection	IP 68 – 10 bar / IP 69K (NEMA 6 – 150 PSIG)
V-INOX-Ex O-Ring	Buna-N
V-INOX-FKM-Ex O-Ring	FKM
V-INOX-VMQ-Ex O-Ring	VMQ
Operating Temperature	-20 °C – 95 °C (-4 °F – 203 °F) (Buna-N) -20 °C – 180 °C (-4 °F – 356 °F) (FKM) / -60 °C – 180 °C (-76 °F – 356 °F) (VMQ)



II 2G 1D

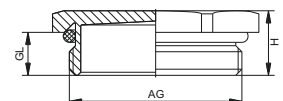

AG	GL mm	H mm	⌀ mm	Number V-INOX-Ex -20 °C – 95 °C	Number V-INOX-FKM-Ex -20 °C – 180 °C	Number V-INOX-VMQ-Ex -60 °C – 180 °C
PG 7	5	8	14	1.192.0700.01	1.193.0700.01	1.194.0700.01
PG 9	6	9	17	1.192.0900.01	1.193.0900.01	1.194.0900.01
PG 11	6	9,5	20	1.192.1100.01	1.193.1100.01	1.194.1100.01
PG 13,5	6,5	10	22	1.192.1300.01	1.193.1300.01	1.194.1300.01
PG 16	6,5	10	24	1.192.1600.01	1.193.1600.01	1.194.1600.01
PG 21	7	10,5	30	1.192.2100.01	1.193.2100.01	1.194.2100.01
PG 29	8	12,5	41	1.192.2900.01	1.193.2900.01	1.194.2900.01
PG 36	8	13	50	1.192.3600.01	1.193.3600.01	1.194.3600.01
PG 42	9	15	58	1.192.4200.01	1.193.4200.01	1.194.4200.01
PG 48	10	16,5	65	1.192.4800.01	1.193.4800.01	1.194.4800.01

Plug RSD-INOX-Ex

Metr.

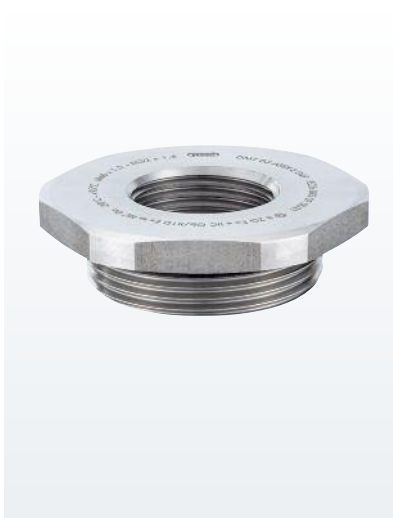

Material	INOX 1.4305
O-Ring	Buna-N / VMQ
Protection	IP 68 – 10 bar / IP 69K (NEMA 6 – 150 PSIG)
Operating Temperature	-20 °C – 95 °C (-4 °F – 203 °F) (Buna-N) -60 °C – 180 °C (-76 °F – 356 °F) (VMQ)

ATEX Ex

II 2G 1D

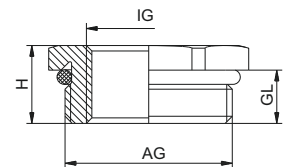

AG	IG	GL mm			Number	
					Buna-N -20 °C – 95 °C	VMQ -60 °C – 180 °C
M 16 x 1,5	M 12 x 1,5	5	19		1.098.1612.50	1.099.1612.50
M 20 x 1,5	M 12 x 1,5	6	22		1.098.2012.50	1.099.2012.50
M 20 x 1,5	M 16 x 1,5	6	22		1.098.2016.50	1.099.2016.50
M 25 x 1,5	M 16 x 1,5	7	30		1.098.2516.50	1.099.2516.50
M 25 x 1,5	M 20 x 1,5	7	30		1.098.2520.50	1.099.2520.50
M 32 x 1,5	M 16 x 1,5	8	41		1.098.3216.50	1.099.3216.50
M 32 x 1,5	M 20 x 1,5	8	41		1.098.3220.50	1.099.3220.50
M 32 x 1,5	M 25 x 1,5	8	41		1.098.3225.50	1.099.3225.50
M 40 x 1,5	M 20 x 1,5	8	46		1.098.4020.50	1.099.4020.50
M 40 x 1,5	M 25 x 1,5	8	46		1.098.4025.50	1.099.4025.50
M 40 x 1,5	M 32 x 1,5	8	46		1.098.4032.50	1.099.4032.50
M 50 x 1,5	M 25 x 1,5	9	55		1.098.5025.50	1.099.5025.50
M 50 x 1,5	M 32 x 1,5	9	55		1.098.5032.50	1.099.5032.50
M 63 x 1,5	M 32 x 1,5	10	65		1.098.6332.50	1.099.6332.50
M 63 x 1,5	M 50 x 1,5	10	65		1.098.6350.50	1.099.6350.50

Plastic

Metal

EMC

Special applications, DIN

Accessories

Ex

EMC-Ex

Ex Accessories

EXIOS

Plug RSD-INOX-Ex PG

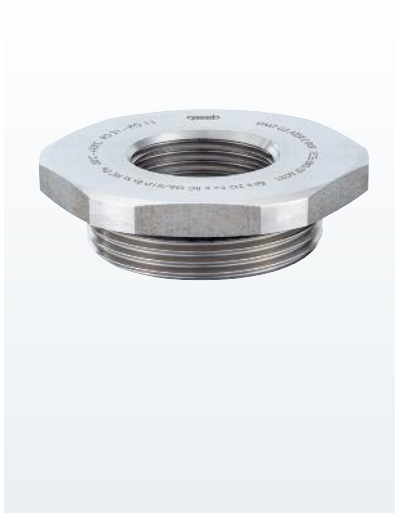

Material	INOX 1.4305
O-Ring	Buna-N / VMQ
Protection	IP 68 – 10 bar / IP 69K (NEMA 6 – 150 PSIG)
Operating Temperature	-20 °C – 95 °C (-4 °F – 203 °F) (Buna-N) -60 °C – 180 °C (-76 °F – 356 °F) (VMQ)

II 2G 1D

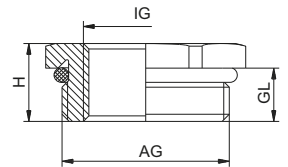

AG	IG	GL mm	H mm	⌀ mm	Number Buna-N -20 °C – 95 °C	Number VMQ -60 °C – 180 °C
PG 9	PG 7	6	8,8	17	1.098.0907.01	1.099.0907.01
PG 11	PG 7	6	9	20	1.098.1107.01	1.099.1107.01
PG 11	PG 9	6	9	20	1.098.1109.01	1.099.1109.01
PG 13,5	PG 9	6,5	9,5	22	1.098.1309.01	1.099.1309.01
PG 13,5	PG 11	6,5	9,5	22	1.098.1311.01	1.099.1311.01
PG 16	PG 9	6,5	9,5	24	1.098.1609.01	1.099.1609.01
PG 16	PG 11	6,5	9,5	24	1.098.1611.01	1.099.1611.01
PG 16	PG 13,5	6,5	9,5	24	1.098.1613.01	1.099.1613.01
PG 21	PG 11	7	10,3	30	1.098.2111.01	1.099.2111.01
PG 21	PG 13,5	7	10,3	30	1.098.2113.01	1.099.2113.01
PG 21	PG 16	7	10,3	30	1.098.2116.01	1.099.2116.01
PG 29	PG 16	8	11,5	40	1.098.2916.01	1.099.2916.01
PG 29	PG 21	8	11,5	40	1.098.2921.01	1.099.2921.01
PG 36	PG 21	9	12,5	50	1.098.3621.01	1.099.3621.01
PG 36	PG 29	9	12,5	50	1.098.3629.01	1.099.3629.01
PG 42	PG 29	10	13,5	57	1.098.4229.01	1.099.4229.01
PG 42	PG 36	10	13,5	57	1.098.4236.01	1.099.4236.01
PG 48	PG 36	10	13,5	64	1.098.4836.01	1.099.4836.01
PG 48	PG 42	10	13,5	64	1.098.4842.01	1.099.4842.01

Plug V-INOX-Ex d

Metr., NPT



Material	INOX 1.4404
O-Ring	Buna-N /FKM /VMQ
Protection	IP 68 – 10 bar /IP 69K (NEMA 6 – 150 PSIG)
Operating Temperature	-20 °C – 95 °C (-4 °F – 203 °F) (Buna-N) -20 °C – 180 °C (-4 °F – 356 °F) (FKM) / -60 °C – 180 °C (-76 °F – 356 °F) (VMQ)



II 2G 1D Ex d IIC

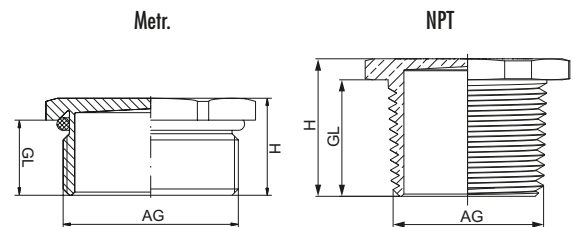

AG	GL mm	H mm		Number without O-Ring self sealing	Number Buna-N -20 °C – 95 °C	Number FKM -20 °C – 180 °C	Number VMQ -60 °C – 180 °C
M 12 x 1,5	16	19	14		1.895.1200.50	1.896.1200.50	1.897.1200.50
M 16 x 1,5	16	19	19		1.895.1600.50	1.896.1600.50	1.897.1600.50
M 20 x 1,5	16	19,5	22		1.895.2000.50	1.896.2000.50	1.897.2000.50
M 25 x 1,5	16	19,5	30		1.895.2500.50	1.896.2500.50	1.897.2500.50
M 32 x 1,5	16	20,5	41		1.895.3200.50	1.896.3200.50	1.897.3200.50
M 40 x 1,5	16	21	46		1.895.4000.50	1.896.4000.50	1.897.4000.50
M 50 x 1,5	16	22	55		1.895.5000.50	1.896.5000.50	1.897.5000.50
M 63 x 1,5	16	22,5	70		1.895.6300.50	1.896.6300.50	1.897.6300.50
NPT 3/8"	16	20	19	1.897.3800.70			
NPT 1/2"	20	23,5	24	1.897.1200.70			
NPT 3/4"	20,5	24	30	1.897.3400.70			
NPT 1"	25	29,5	41	1.897.1000.70			
NPT 1 1/4"	26	31	46	1.897.5400.70			
NPT 1 1/2"	26,5	32,5	55	1.897.6400.70			

Adapter RSD-INOX-Ex d Metr.

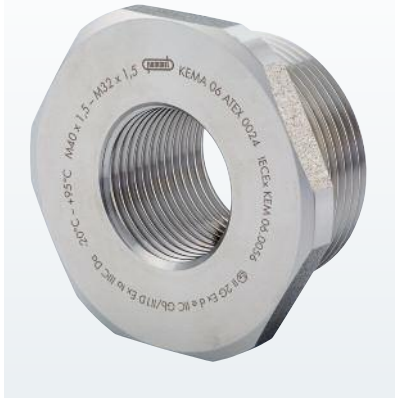

Material	INOX 1.4404
O-Ring	Buna-N / FKM
Protection	IP 68 – 10 bar / IP 69K (NEMA 6 – 150 PSIG)
Operating Temperature	-20 °C – 95 °C (-4 °F – 203 °F) (Buna-N) -60 °C – 180 °C (-76 °F – 356 °F) (VMQ)



II 2G 1D Ex d IIC

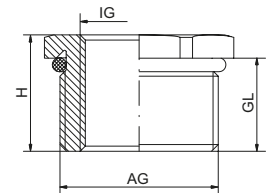

AG	IG	GL mm	H mm	 mm	Number Buna-N -20 °C – 95 °C	Number VMQ -60 °C – 180 °C
M 16 x 1,5	M 12 x 1,5	16	19	19	1.898.1612.50	1.899.1612.50
M 20 x 1,5	M 12 x 1,5	16	19,5	22	1.898.2012.50	1.899.2012.50
M 20 x 1,5	M 16 x 1,5	16	19,5	22	1.898.2016.50	1.899.2016.50
M 25 x 1,5	M 16 x 1,5	16	19,5	30	1.898.2516.50	1.899.2516.50
M 25 x 1,5	M 20 x 1,5	16	19,5	30	1.898.2520.50	1.899.2520.50
M 32 x 1,5	M 16 x 1,5	16	20,5	41	1.898.3216.50	1.899.3216.50
M 32 x 1,5	M 20 x 1,5	16	20,5	41	1.898.3220.50	1.899.3220.50
M 32 x 1,5	M 25 x 1,5	16	20,5	41	1.898.3225.50	1.899.3225.50
M 40 x 1,5	M 20 x 1,5	16	21	46	1.898.4020.50	1.899.4020.50
M 40 x 1,5	M 25 x 1,5	16	21	46	1.898.4025.50	1.899.4025.50
M 40 x 1,5	M 32 x 1,5	16	21	46	1.898.4032.50	1.899.4032.50

EXIOS CABLE GLANDS FOR „HAZARDOUS AREAS“



Cable glands for all popular threads, used in electrical equipment and hazardous areas in Group I, II and III applications. The Ex d, Ex e and / or Ex ta certified cable glands have been designed for all explosion proof areas which are in need of high standards, reliability, strain relief and water proof requirements, e.g. marine, offshore, gas conveying machinery, refineries and chemical industry.

- // **EXIOS⁺ STANDARD** The innovative HUMMEL high-end cable gland for armoured cables in hazardous areas including the latest IECEx and ATEX certifications, for the use in Ex e, Ex d and Ex ta areas
- // **EXIOS⁺ MZ** High-end cable gland with extra strain relief and zero torsion or armour and wires. For armoured cables in hazardous areas including the latest IECEx and ATEX certifications, for the use in Ex e, Ex d and Ex ta areas.
- // **EXIOS⁺ BARRIER** High-end cable gland for armoured cables in hazardous areas uses a barrier compound sealing. Including the latest IECEx and ATEX certifications, for the use in Ex e, Ex d and Ex ta areas.
- // **EXIOS⁺ A2F** For non-armoured cables for the use in Ex e and Ex d areas
- // Accessories



EXIOS CABLE GLANDS FOR „HAZARDOUS AREAS“

EXIOS⁺ STANDARD

Metr., NPT



Material	Brass
Seal	Silicone, VMQ
Clamping insert	PA 6
Armouring	Metallic Armour or Screen
Protection	IP 66, 67 and 68 (5 bar)
Operating Temperature	-60°C – 105°C (-76°F – 221°F)

// INOX upon request

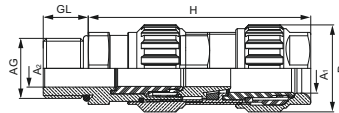

BVS 10 ATEX E 062 X

II 2G Ex de IIC Gb
II 1D Ex ta IIIC Da

IECEx BVS 10.0078X

RU C-DE.AA87.B.01078

TÜV 12.0321X

12.2557737X

AG	Size	A1 mm	A2 mm	GL mm	H max. mm	Ø mm	D mm	Armouring Ø mm			Number
								Clamping ring 1	Clamping ring 2	Clamping ring optional	
M 16 x1,5	20-1	6-12	3-8,1	16	69,5	22	27	0-0,7	0,7-1,25		1.605.1600.50
M 20 x1,5	20-1	6-12	3-8,1	16	69,5	22	27	0-0,7	0,7-1,25		1.605.2000.50
M 20 x1,5	20-2	9-16	6-12	16	74,3	24	29	0-0,7	0,7-1,25		1.605.2000.51
M 20 x1,5	20-3	12,5-20,5	9-14	16	80,5	30	35	0-0,7	0,7-1,4		1.605.2000.52
M 25 x1,5	20-3	12,5-20,5	9-14	16	80,5	30	35	0-0,7	0,7-1,4		1.605.2500.51
M 25 x1,5	25	16,9-26	12,5-20,5	16	91	36	42	0-0,7	0,9-1,6	0,7-1,4	1.605.2500.50
M 32 x1,5	32	22-33	16,9-26	16	96	46	52	0-0,7	1,3-2,0	0,7-1,4	1.605.3200.50
M 40 x1,5	40	28-41	22-33	16	107	55	64	0-0,7	1,3-2,0	0,7-1,4	1.605.4000.50
M 50 x1,5	50	36-52,6	28,9-44,4	16	131,5	65	73	0-1,0	1,5-2,5	1,0-2,0	1.605.5000.50
M 63 x1,5	63	46-65,3	39,9-56,3	16	144,5	80	90	0-1,0	1,5-2,5	1,0-2,0	1.605.6300.50
M 75 x1,5	75	57-78	50,5-68,2	16	154	95	107	0-1,0	1,5-2,5	1,0-2,0	1.605.7500.50
NPT 3/8"	20-1	6-12	3-8,1	16	69,5	22	27	0-0,7	0,7-1,25		1.605.3800.70
NPT 1/2"	20-2	9-16	6-12	20	74,3	24	29	0-0,7	0,7-1,25		1.605.1200.70
NPT 1/2"	20-3	12,5-20,5	9-14	20	80,5	30	35	0-0,7	0,7-1,4		1.605.1200.71
NPT 3/4"	25	16,9-26	12,5-20,5	20,5	91	36	42	0-0,7	0,9-1,6	0,7-1,4	1.605.3400.70
NPT 1"	32	22-33	16,9-26	25	96	46	52	0-0,7	1,3-2,0	0,7-1,4	1.605.1000.70
NPT 1 1/4"	40	28-41	22-33	26	107	55	64	0-0,7	1,3-2,0	0,7-1,4	1.605.5400.70
NPT 1 1/2"	40	28-41	22-33	26,5	107	55	64	0-0,7	1,3-2,0	0,7-1,4	1.605.6400.70
NPT 2"	50	36-52,6	28,9-44,4	27	131,5	65	73	0-1,0	1,5-2,5	1,0-2,0	1.605.2000.70
NPT 2 1/2"	63	46-65,3	39,9-56,3	40	144,5	80	90	0-1,0	1,5-2,5	1,0-2,0	1.605.5200.70
NPT 3"	75	57-78	50,5-68,2	41,5	154	95	107	0-1,0	1,5-2,5	1,0-2,0	1.605.3000.70

EXIOS CABLE GLANDS FOR „HAZARDOUS AREAS“

EXIOS⁺ STANDARD

Metr., NPT



Material	Nickel plated brass
Seal	Silicone, VMQ
Clamping insert	PA 6
Armouring	Metallic Armour or Screen
Protection	IP 66, 67 and 68 (5 bar)
Operating Temperature	-60°C – 105°C (-76°F – 221°F)

// INOX upon request

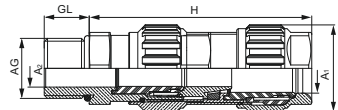

AG	Size	∅k A1 mm	∅k A2 mm	GL mm	H max. mm	∅ mm	D mm	Armouring ∅ mm			Number
								Clamping ring 1	Clamping ring 2	Clamping ring optional	
M 16 x1,5	20-1	6-12	3-8,1	16	69,5	22	27	0-0,7	0,7-1,25		1.605.1603.50
M 20 x1,5	20-1	6-12	3-8,1	16	69,5	22	27	0-0,7	0,7-1,25		1.605.2003.50
M 20 x1,5	20-2	9-16	6-12	16	74,3	24	29	0-0,7	0,7-1,25		1.605.2003.51
M 20 x1,5	20-3	12,5-20,5	9-14	16	80,5	30	35	0-0,7	0,7-1,4		1.605.2003.52
M 25 x1,5	20-3	12,5-20,5	9-14	16	80,5	30	35	0-0,7	0,7-1,4		1.605.2503.51
M 25 x1,5	25	16,9-26	12,5-20,5	16	91	36	42	0-0,7	0,9-1,6	0,7-1,4	1.605.2503.50
M 32 x1,5	32	22-33	16,9-26	16	96	46	52	0-0,7	1,3-2,0	0,7-1,4	1.605.3203.50
M 40 x1,5	40	28-41	22-33	16	107	55	64	0-0,7	1,3-2,0	0,7-1,4	1.605.4003.50
M 50 x1,5	50	36-52,6	28,9-44,4	16	131,5	65	73	0-1,0	1,5-2,5	1,0-2,0	1.605.5003.50
M 63 x1,5	63	46-65,3	39,9-56,3	16	144,5	80	90	0-1,0	1,5-2,5	1,0-2,0	1.605.6303.50
M 75 x1,5	75	57-78	50,5-68,2	16	154	95	107	0-1,0	1,5-2,5	1,0-2,0	1.605.7503.50
NPT 3/8"	20-1	6-12	3-8,1	16	69,5	22	27	0-0,7	0,7-1,25		1.605.3803.70
NPT 1/2"	20-2	9-16	6-12	20	74,3	24	29	0-0,7	0,7-1,25		1.605.1203.70
NPT 1/2"	20-3	12,5-20,5	9-14	20	80,5	30	35	0-0,7	0,7-1,4		1.605.1203.71
NPT 3/4"	25	16,9-26	12,5-20,5	20,5	91	36	42	0-0,7	0,9-1,6	0,7-1,4	1.605.3403.70
NPT 1"	32	22-33	16,9-26	25	96	46	52	0-0,7	1,3-2,0	0,7-1,4	1.605.1003.70
NPT 1 1/4"	40	28-41	22-33	26	107	55	64	0-0,7	1,3-2,0	0,7-1,4	1.605.5403.70
NPT 1 1/2"	40	28-41	22-33	26,5	107	55	64	0-0,7	1,3-2,0	0,7-1,4	1.605.6403.70
NPT 2"	50	36-52,6	28,9-44,4	27	131,5	65	73	0-1,0	1,5-2,5	1,0-2,0	1.605.2003.70
NPT 2 1/2"	63	46-65,3	39,9-56,3	40	144,5	80	90	0-1,0	1,5-2,5	1,0-2,0	1.605.5203.70
NPT 3"	75	57-78	50,5-68,2	41,5	154	95	107	0-1,0	1,5-2,5	1,0-2,0	1.605.3003.70

Plastic

Metal

EMC

Special applications, DIN

Accessories

Ex

EMC-Ex

Ex Accessories

EXIOS

EXIOS CABLE GLANDS FOR „HAZARDOUS AREAS“

EXIOS⁺MZ

Metr., NPT



Material	Brass
Seal	Silicone, VMQ
Clamping insert	PA 6
Armouring	Metallic Armour or Screen
Protection	IP 66, 67 and 68 (5 bar)
Operating Temperature	-60°C – 105°C (-76°F – 221°F)

// INOX upon request



ATEX^{Ex} BVS 10 ATEX E 062 X

Ex II 2G Ex de IIC Gb
II 1D Ex ta IIIC Da

IECEx IECEx BVS 10.0078X

EAC RU C-DE.AA87.B.01078

CS 12.2557737X

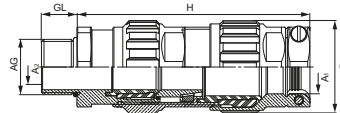

AG	Size	A1 mm	A2 mm	GL mm	H max. mm	R mm	D mm	Armouring Ø mm			Number
								Clamping ring 1	Clamping ring 2	Clamping ring optional	
M 16 x1,5	20-1	6-11	3-8,1	16	79	22	27	0-0,7	0,7-1,25		1.675.1600.50
M 20 x1,5	20-1	6-11	3-8,1	16	79	22	27	0-0,7	0,7-1,25		1.675.2000.50
M 20 x1,5	20-2	9-13	6-12	16	83,8	24	29	0-0,7	0,7-1,25		1.675.2000.51
M 20 x1,5	20-3	12,5-17,5	9-14	16	91,5	30	35	0-0,7	0,7-1,4		1.675.2000.52
M 25 x1,5	20-3	12,5-17,5	9-14	16	91,5	30	35	0-0,7	0,7-1,4		1.675.2500.51
M 25 x1,5	25	16,9-24	12,5-20,5	16	105,7	36	42	0-0,7	0,9-1,6	0,7-1,4	1.675.2500.50
M 32 x1,5	32	22-32,5	16,9-26	16	107	46	52	0-0,7	1,3-2,0	0,7-1,4	1.675.3200.50
M 40 x1,5	40	28-41	22-33	16	120	55	64	0-0,7	1,3-2,0	0,7-1,4	1.675.4000.50
M 50 x1,5	50	36-39,5	28,9-44,4	16	144,5	65	73	0-1,0	1,5-2,5	1,0-2,0	1.675.5000.50
M 63 x1,5	63	46-64	39,9-56,3	16	157,5	80	90	0-1,0	1,5-2,5	1,0-2,0	1.675.6300.50
M 75 x1,5	75	57-78	50,5-68,2	16	167	95	107	0-1,0	1,5-2,5	1,0-2,0	1.675.7500.50
NPT 3/8"	20-1	6-11	3-8,1	16	79	22	27	0-0,7	0,7-1,25		1.675.3800.70
NPT 1/2"	20-2	9-13	6-12	20	83,8	24	29	0-0,7	0,7-1,25		1.675.1200.70
NPT 1/2"	20-3	12,5-17,5	9-14	20	91,5	30	35	0-0,7	0,7-1,4		1.675.1200.71
NPT 3/4"	25	16,9-24	12,5-20,5	20,5	105,7	36	42	0-0,7	0,9-1,6	0,7-1,4	1.675.3400.70
NPT 1"	32	22-32,5	16,9-26	25	107	46	52	0-0,7	1,3-2,0	0,7-1,4	1.675.1000.70
NPT 1 1/4"	40	28-39,5	22-33	26	120	55	64	0-0,7	1,3-2,0	0,7-1,4	1.675.5400.70
NPT 1 1/2"	40	28-39,5	22-33	26,5	120	55	64	0-0,7	1,3-2,0	0,7-1,4	1.675.6400.70
NPT 2"	50	36-49	28,9-44,4	27	144,5	65	73	0-1,0	1,5-2,5	1,0-2,0	1.675.2000.70
NPT 2 1/2"	63	46-64	39,9-56,3	40	157,5	80	90	0-1,0	1,5-2,5	1,0-2,0	1.675.5200.70
NPT 3"	75	57-78	50,5-68,2	41,5	167	95	107	0-1,0	1,5-2,5	1,0-2,0	1.675.3000.70

EXIOS CABLE GLANDS FOR „HAZARDOUS AREAS“

EXIOS⁺MZ

Metr., NPT



Material	Nickel plated brass
Seal	Silicone, VMQ
Clamping insert	PA 6
Armouring	Metallic Armour or Screen
Protection	IP 66, 67 and 68 (5 bar)
Operating Temperature	-60°C – 105°C (-76°F – 221°F)

// INOX upon request



ATEX_{Ex} BVS 10 ATEX E 062 X

Ex II 2G Ex de IIC Gb
II 1D Ex ta IIIC Da

IECEx IECEx BVS 10.0078X

EAC RU C-DE.AA87.B.01078

SP 12.2557737X

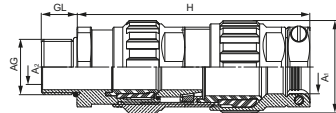

AG	Size	∅A1 mm	∅A2 mm	GL mm	H max. mm	R mm	D mm	Armouring Ø mm			Number
								Clamping ring 1	Clamping ring 2	Clamping ring optional	
M 16 x1,5	20-1	6-11	3-8,1	16	79	22	27	0-0,7	0,7-1,25		1.675.1603.50
M 20 x1,5	20-1	6-11	3-8,1	16	79	22	27	0-0,7	0,7-1,25		1.675.2003.50
M 20 x1,5	20-2	9-13	6-12	16	83,8	24	29	0-0,7	0,7-1,25		1.675.2003.51
M 20 x1,5	20-3	12,5-17,5	9-14	16	91,5	30	35	0-0,7	0,7-1,4		1.675.2003.52
M 25 x1,5	20-3	12,5-17,5	9-14	16	91,5	30	35	0-0,7	0,7-1,4		1.675.2503.51
M 25 x1,5	25	16,9-24	12,5-20,5	16	105,7	36	42	0-0,7	0,9-1,6	0,7-1,4	1.675.2503.50
M 32 x1,5	32	22-32,5	16,9-26	16	107	46	52	0-0,7	1,3-2,0	0,7-1,4	1.675.3203.50
M 40 x1,5	40	28-41	22-33	16	120	55	64	0-0,7	1,3-2,0	0,7-1,4	1.675.4003.50
M 50 x1,5	50	36-39,5	28,9-44,4	16	144,5	65	73	0-1,0	1,5-2,5	1,0-2,0	1.675.5003.50
M 63 x1,5	63	46-64	39,9-56,3	16	157,5	80	90	0-1,0	1,5-2,5	1,0-2,0	1.675.6303.50
M 75 x1,5	75	57-78	50,5-68,2	16	167	95	107	0-1,0	1,5-2,5	1,0-2,0	1.675.7503.50
NPT 3/8"	20-1	6-11	3-8,1	16	79	22	27	0-0,7	0,7-1,25		1.675.3803.70
NPT 1/2"	20-2	9-13	6-12	20	83,8	24	29	0-0,7	0,7-1,25		1.675.1203.70
NPT 1/2"	20-3	12,5-17,5	9-14	20	91,5	30	35	0-0,7	0,7-1,4		1.675.1203.71
NPT 3/4"	25	16,9-24	12,5-20,5	20,5	105,7	36	42	0-0,7	0,9-1,6	0,7-1,4	1.675.3403.70
NPT 1"	32	22-32,5	16,9-26	25	107	46	52	0-0,7	1,3-2,0	0,7-1,4	1.675.1003.70
NPT 1 1/4"	40	28-39,5	22-33	26	120	55	64	0-0,7	1,3-2,0	0,7-1,4	1.675.5403.70
NPT 1 1/2"	40	28-39,5	22-33	26,5	120	55	64	0-0,7	1,3-2,0	0,7-1,4	1.675.6403.70
NPT 2"	50	36-49	28,9-44,4	27	144,5	65	73	0-1,0	1,5-2,5	1,0-2,0	1.675.2003.70
NPT 2 1/2"	63	46-64	39,9-56,3	40	157,5	80	90	0-1,0	1,5-2,5	1,0-2,0	1.675.5203.70
NPT 3"	75	57-78	50,5-68,2	41,5	167	95	107	0-1,0	1,5-2,5	1,0-2,0	1.675.3003.70

EXIOS CABLE GLANDS FOR „HAZARDOUS AREAS“

EXIOS⁺ BARRIER

Metr., NPT



Material	Brass
Seal	Silicone, VMQ
Clamping insert	PA 6
Armouring	Metallic Armour or Screen
Compound	Two-component epoxy compound
Protection	IP 66, 67 and 68 (5 bar)
Operating Temperature	-60 °C – 85 °C (-76 °F – 185 °F)

// INOX upon request

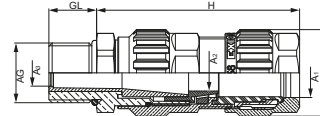

ATEX^{Ex} Sira 11 ATEX 1110 X

I M2 Ex de I Mb IIC Gb
I M2 Ex ta I IIIC Da

IECEx SIR 11.0044X

RU C-DE.AA87.B.01078

TÜV 12.0175X

12.2557737X

AG	Size	A1 mm	A2 mm	A3 mm	GL mm	H max. mm	mm	D mm	Max. No. cores	Armouring Ø mm		Number
										Clamping ring 1	Clamping ring 2	
M 16 x1,5	20-1	6-12	8,2	7,9	16	68,5	22	27	8	0-0,7	0,7-1,25	1.606.1600.50
M 20 x1,5	20-1	6-12	8,2	7,9	16	68,5	22	27	8	0-0,7	0,7-1,25	1.606.2000.51
M 20 x1,5	20-2	9-16	12	8,8	16	74,3	24	29	10	0-0,7	0,7-1,25	1.606.2000.51
M 20 x1,5	20-3	12,5-20,5	14	11,5	16	80,5	30	35	15	0-0,7	0,7-1,4	1.606.2000.52
M 25 x1,5	20-3	12,5-20,5	14	11,5	16	80,5	30	35	15	0-0,7	0,7-1,4	1.606.2500.51
M 25 x1,5	25	16,9-26	20	16,4	16	91	36	42	25	0-0,7	0,9-1,6	1.606.2500.50
M 32 x1,5	32	22-32,5	26	21,4	16	96	46	52	45	0-0,7	1,3-2,0	1.606.3200.50
M 40 x1,5	40	28-41	33,2	27,6	16	107	55	64	70	0-0,7	1,3-2,0	1.606.4000.50
M 50 x1,5	50	36-52,6	44,2	37,5	16	131,5	65	73	85	0-1,0	1,5-2,5	1.606.5000.50
M 63 x1,5	63	46-65,3	56,2	47,3	16	144,5	80	90	120	0-1,0	1,5-2,5	1.606.6300.50
M 75 x1,5	75	57-78	68,2	58,0	16	154	95	107	150	0-1,0	1,5-2,5	1.606.7500.50
NPT 3/8"	20-1	6-12	8,2	7,9	16	64	22	27	8	0-0,7	0,7-1,25	1.606.3800.70
NPT 1/2"	20-2	9-12	12	8,8	20	68	24	29	10	0-0,7	0,7-1,25	1.606.1200.70
NPT 1/2"	20-3	12,5-20,5	14	11,5	20	73	30	35	15	0-0,7	0,7-1,4	1.606.1200.71
NPT 3/4"	25	16,9-26	20	16,4	20,5	81,3	36	42	25	0-0,7	0,9-1,6	1.606.3400.70
NPT 1"	32	22-32,5	26	21,4	25	85,5	46	52	45	0-0,7	1,3-2,0	1.606.1000.70
NPT 1 1/4"	40	28-41	33,2	27,6	26	94,4	55	64	70	0-0,7	1,3-2,0	1.606.5400.70
NPT 1 1/2"	40	28-41	33,2	27,6	26,5	94,4	55	64	70	0-0,7	1,3-2,0	1.606.6400.70
NPT 2"	50	36-52,6	44,2	37,5	27	116,3	65	73	85	0-1,0	1,5-2,5	1.606.2000.70
NPT 2 1/2"	63	46-65,3	56,2	47,3	40	127,6	80	90	120	0-1,0	1,5-2,5	1.606.5200.70
NPT 3"	75	57-78	68,2	58,0	41,5	136,5	95	107	150	0-1,0	1,5-2,5	1.606.3000.70

EXIOS CABLE GLANDS FOR „HAZARDOUS AREAS“

EXIOS⁺ BARRIER

Metr., NPT



Material	Nickel plated brass
Seal	Silicone, VMQ
Clamping insert	PA 6
Armouring	Metallic Armour or Screen
Compound	Two-component epoxy compound
Protection	IP 66, 67 and 68 (5 bar)
Operating Temperature	-60 °C – 85 °C (-76 °F – 185 °F)

// INOX upon request

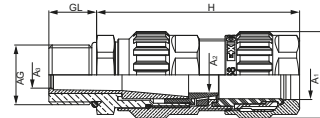

AG	Size	∅ A1 mm	∅ A2 mm	∅ A3 mm	GL mm	H max. mm	mm	D mm	Max. No. cores	Armouring ∅ mm		Number
										Clamping ring 1	Clamping ring 2	
M 16 x1,5	20-1	6-12	8,2	7,9	16	68,5	22	27	8	0-0,7	0,7-1,25	1.606.1603.50
M 20 x1,5	20-1	6-12	8,2	7,9	16	68,5	22	27	8	0-0,7	0,7-1,25	1.606.2003.50
M 20 x1,5	20-2	9-16	12	8,8	16	74,3	24	29	10	0-0,7	0,7-1,25	1.606.2003.51
M 20 x1,5	20-3	12,5-20,5	14	11,5	16	80,5	30	35	15	0-0,7	0,7-1,4	1.606.2003.52
M 25 x1,5	20-3	12,5-20,5	14	11,5	16	80,5	30	35	15	0-0,7	0,7-1,4	1.606.2503.51
M 25 x1,5	25	16,9-26	20	16,4	16	91	36	42	25	0-0,7	0,9-1,6	1.606.2503.50
M 32 x1,5	32	22-32,5	26	21,4	16	96	46	52	45	0-0,7	1,3-2,0	1.606.3203.50
M 40 x1,5	40	28-41	33,2	27,6	16	107	55	64	70	0-0,7	1,3-2,0	1.606.4003.50
M 50 x1,5	50	36-52,6	44,2	37,5	16	131,5	65	73	85	0-1,0	1,5-2,5	1.606.5003.50
M 63 x1,5	63	46-65,3	56,2	47,3	16	144,5	80	90	120	0-1,0	1,5-2,5	1.606.6303.50
M 75 x1,5	75	57-78	68,2	58,0	16	154	95	107	150	0-1,0	1,5-2,5	1.606.7503.50
NPT 3/8"	20-1	6-12	8,2	7,9	16	64	22	27	8	0-0,7	0,7-1,25	1.606.3803.70
NPT 1/2"	20-2	9-12	12	8,8	20	68	24	29	10	0-0,7	0,7-1,25	1.606.1203.70
NPT 1/2"	20-3	12,5-20,5	14	11,5	20	73	30	35	15	0-0,7	0,7-1,4	1.606.1203.71
NPT 3/4"	25	16,9-26	20	16,4	20,5	81,3	36	42	25	0-0,7	0,9-1,6	1.606.3403.70
NPT 1"	32	22-32,5	26	21,4	25	85,5	46	52	45	0-0,7	1,3-2,0	1.606.1003.70
NPT 1 1/4"	40	28-41	33,2	27,6	26	94,4	55	64	70	0-0,7	1,3-2,0	1.606.5403.70
NPT 1 1/2"	40	28-41	33,2	27,6	26,5	94,4	55	64	70	0-0,7	1,3-2,0	1.606.6403.70
NPT 2"	50	36-52,6	44,2	37,5	27	116,3	65	73	85	0-1,0	1,5-2,5	1.606.2003.70
NPT 2 1/2"	63	46-65,3	56,2	47,3	40	127,6	80	90	120	0-1,0	1,5-2,5	1.606.5203.70
NPT 3"	75	57-78	68,2	58,0	41,5	136,5	95	107	150	0-1,0	1,5-2,5	1.606.3003.70

EXIOS CABLE GLANDS FOR „HAZARDOUS AREAS“

EXIOS⁺A2F

Metr., NPT



Material	Brass
Seal	Silicone, VMQ
Clamping insert	PA 6
Protection	IP 66, 67 and 68 (5 bar)
Operating Temperature	-60 °C – 105 °C (-76 °F – 221 °F)

// INOX upon request

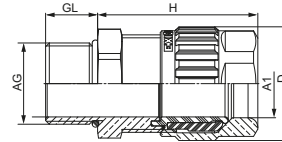

AG	Size	∅k A1 mm	GL mm	H max. mm	∅ mm	D mm	Number	Number Nickel plated brass
M 16 x 1,5	20-1	6-12	16	36,5	22	27	1.608.1600.50	1.608.1603.50
M 20 x 1,5	20-1	6-12	16	36,5	22	27	1.608.2000.50	1.608.2003.50
M 20 x 1,5	20-2	9-16	16	41	24	29	1.608.2000.51	1.608.2003.51
M 25 x 1,5	20-3	12,5-20,5	16	48	30	35	1.608.2500.50	1.608.2503.50
M 32 x 1,5	25	16,9-26	16	48,5	36	42	1.608.3200.50	1.608.3203.50
M 40 x 1,5	32	22-33	16	54	46	52	1.608.4000.50	1.608.4003.50
M 50 x 1,5	40	28-41	16	60	55	64	1.608.5000.50	1.608.5003.50
M 63 x 1,5	50	40-52,6	16	67	65	73	1.608.6300.50	1.608.6303.50
M 75 x 1,5	63	51-65,3	16	72	80	90	1.608.7500.50	1.608.7503.50
NPT 3/8"	20-1	6-12	16	35,6	22	27	1.608.3800.70	1.608.3803.70
NPT 1/2"	20-1	6-12	20	35,6	22/24	27	1.608.1200.70	1.608.1203.70
NPT 1/2"	20-2	9-16	20	39,7	24	29	1.608.1200.71	1.608.1203.71
NPT 3/4"	20-3	12,5-20,5	20,5	47,5	30	35	1.608.3400.70	1.608.3403.70
NPT 1"	25	16,9-26	25	47,8	36	42	1.608.1000.70	1.608.1003.70
NPT 1 1/4"	32	22-33	26	51,1	46	52	1.608.5400.70	1.608.5403.70
NPT 1 1/2"	40	28-41	26,5	56,8	55	64	1.608.6400.70	1.608.6403.70
NPT 2"	50	40-52,6	27	65,4	65	73	1.608.2000.70	1.608.2003.70
NPT 2 1/2"	63	51-61	40	70,3	80	90	1.608.5200.70	1.608.5203.70
NPT 3"	75	62-78	41,5	76,2	95	107	1.608.3000.70	1.608.3003.70

Thread Seal Ring

Metr., NPT



GFK thread seal

Material Fiber reinforced Nylon

Operating Temperature -60 °C – 105 °C (-76 °F – 221 °F)

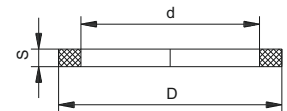

Fits the following sizes	D	d	S	Number
M 16	24	16,1	1,5	1.326.1600.50
M 20	28,5	20,5	1,5	1.326.2000.50
M 25	36,5	25,5	1,6	1.326.2500.50
M 32	42,5	32,5	1,6	1.326.3200.50
M 40	51,5	40	1,5	1.326.4000.50
M 50	61,5	51	1,6	1.326.5000.50
M 63	76	63,5	1,6	1.326.6300.50
M 75	87,5	75,5	1,8	1.326.7500.50

Fits the following sizes	D	d	S	Number
3/8"	25,5	17,5	1,5	1.326.3800.70
1/2"	30	22	1,5	1.326.1200.70
3/4"	33,5	26,5	1,5	1.326.3400.70
1"	42,5	34	1,6	1.326.1000.70
1 1/4"	52	42,5	1,6	1.326.5400.70
1 1/2"	58,7	50	1,5	1.326.6400.70
2"	69,5	60,8	1,6	1.326.2000.70
2 1/2"	83	73,8	1,5	1.326.5200.70
3"	114,5	91,5	1,8	1.326.3000.70

PVC Shroud



Material PVC

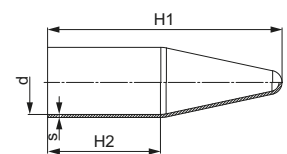

Fits the following sizes	H1 mm	H2 mm	d mm	Number
20 – 1	115	60	26	1.802.2000.50
20 – 2	125	70	28	1.802.2000.51
20 – 3	130	65	34	1.802.2000.52
25	160	90	42	1.802.2500.50
32	165	95	51	1.802.3200.50
40	200	110	63	1.802.4000.50
50	210	115	72	1.802.5000.50
63	245	140	88	1.802.6300.50
75	245	140	108	1.802.7500.50

Earthtag Metr., NPT



Material Brass

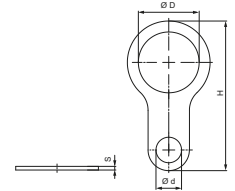

Size	D	d	s	H	Number
M 16	16	6,5	1,5	50,5	1.022.1600.50
M 20	21	7	1,5	54	1.022.2000.50
M 25	25,5	10,5	1,5	61,5	1.022.2500.50
M 32	33,5	12,5	1,5	77	1.022.3200.50
M 40	40,5	13,5	1,5	86,5	1.022.4000.50
M 50	51	13,5	1,5	111	1.022.5000.50
M 63	64	1,5	1,5	128,5	1.022.6300.50
M 75	75,5	13	1,5	138	1.022.7500.50

Size	D	d	s	H	Number
1/2"	21,5	7	1,6	53,5	1.022.1200.70
3/4"	27	10,5	1,6	61,5	1.022.3400.70
1"	35	12,5	1,6	73	1.022.1000.70
1 1/4"	43,5	13,5	1,6	87	1.022.5400.70
1 1/2"	51	12,5	1,6	112	1.022.6400.70
2"	61	13,5	1,6	125,5	1.022.2000.70
2 1/2"	76	13,5	1,6	138	1.022.5200.70

Serrated Washer Metr., NPT



Material INOX 1.4401

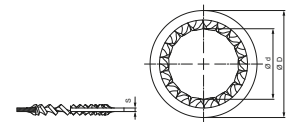

Size	D	d	s	Number
M 16	26,5	17	1,5	1.329.1600.50
M 20	33,5	21,5	1,5	1.329.2000.50
M 25	39	26	1,5	1.329.2500.50
M 32	48	30,5	1,5	1.329.3200.50
M 40	59,5	40,5	1,5	1.329.4000.50
M 50	71	51,5	1,5	1.329.5000.50
M 63	87	64	1,5	1.329.6300.50
M 75	102,5	76,5	1,5	1.329.7500.50

Size	D	d	s	Number
3/8"	30	19,5	1,5	1.329.3800.70
1/2"	39	23,5	1,5	1.329.1200.70
3/4"	42	29,5	1,5	1.329.3400.70
1"	49,5	35	1,5	1.329.1000.70
1 1/4"	59,5	44	1,5	1.329.5400.70
1 1/2"	71	51,5	1,5	1.329.6400.70
2"	86,6	61,5	1,5	1.329.2000.70
2 1/2"	102,5	76,5	1,5	1.329.5200.70

Approvals for HSK Strain Relief Fittings* / Licence Number 40042698, 40012033, 40042701

Page	Article	Number	Temperature Range	Approval G (Gas)	Approval D (Dust)	EC-Type Examination Certificate
133	RSD-MS-Ex	1.078.*	-20 °C–95 °C	x	x	DMT 03 ATEX E 049
133	RSD-MS-Ex	1.079.*	-60 °C–180 °C	x	x	DMT 03 ATEX E 049
137	RSD-INOX-Ex	1.098.*	-20 °C–180 °C	x	x	DMT 03 ATEX E 049
137	RSD-INOX-Ex	1.099.*	-60 °C–180 °C	x	x	DMT 03 ATEX E 049
136	V-INOX-Ex	1.192.*	-20 °C–95 °C	x	x	DMT 03 ATEX E 049
136	V-INOX-FKM-Ex	1.193.*	-20 °C–180 °C	x	x	DMT 03 ATEX E 049
136	V-INOX-VMQ-Ex	1.194.*	-60 °C–180 °C	x	x	DMT 03 ATEX E 049
132	V-MS-Ex	1.197.*	-20 °C–95 °C	x	x	DMT 03 ATEX E 049
132	V-MS-FKM-Ex	1.198.*	-20 °C–180 °C	x	x	DMT 03 ATEX E 049
132	V-MS-VMQ-Ex	1.199.*	-60 °C–180 °C	x	x	DMT 03 ATEX E 049
108	HSK-K-MZ-Ex	1.215.*	-20 °C–70 °C	x	x	KEMA 99 ATEX 6971 X
104-105	HSK-K-Ex-Active	1.292.*	-20 °C–85 °C	x	x	BVS 14 ATEX E 025 X
131	HSK-V-Ex / HSK-V-Ex Mz	1.296.*	-20 °C–95 °C	x	x	BVS 03 ATEX E 298 X
130	V-Ex	1.297.*	-20 °C–90 °C	x	x	DMT 03 ATEX E 049
142-143	EXIOS Standard	1.605.*	-60 °C–105 °C	x	x	BVS 10 ATEX E 062 X
146-147	EXIOS Barrier	1.606.*	-60 °C–85 °C	x	x	Sira 11 ATEX 1110 X
148	EXIOS AZF	1.608.*	-60 °C–105 °C	x	x	DEKRA 12 ATEX 0139 X
110-113, 124-125	HSK-M-Ex / EMC-Ex	1.610.* / 1.616.*	-20 °C–95 °C	x	x	DMT 03 ATEX E 051 X
116, 126-127	HSK-MZ-Ex / EMC-Ex	1.611.* / 1.617.*	-20 °C–95 °C	x	x	DMT 03 ATEX E 051 X
117	HSK-INOX-Ex	1.612.*	-20 °C–95 °C	x	x	DMT 03 ATEX E 051 X
118	HSK-M-Ex d	1.622.*	-60 °C–105 °C	x	x	KEMA 99 ATEX 6968 X
119	HSK-MZ-Ex d	1.628.*	-60 °C–105 °C	x	x	KEMA 99 ATEX 6968 X
120	HSK-INOX-Ex d	1.632.*	-60 °C–105 °C	x	x	KEMA 99 ATEX 6968 X
120	HSK-INOX-PVDF-Ex d	1.633.*	-20 °C–130 °C	x	x	KEMA 99 ATEX 6968 X
118	HSK-M-PVDF-Ex d	1.634.*	-20 °C–130 °C	x	x	KEMA 99 ATEX 6968 X
122-123	HSK-M-EMC-D-Ex	1.636.*	-20 °C–95 °C	x	x	DMT 03 ATEX E 051 X
122-123	HSK-M-EMC-D-Ex	1.637.*	-60 °C–95 °C	x	x	KEMA 99 ATEX 6971 X
110-113, 124-125	HSK-M-Ex / EMC-Ex	1.640.* / 1.646.*	-60 °C–95 °C	x	x	KEMA 99 ATEX 6971 X
126-127	HSK-MZ-EMC-Ex	1.647.*	-60 °C–95 °C	x	x	KEMA 99 ATEX 6971 X
117	HSK-INOX-Ex	1.642.*	-60 °C–95 °C	x	x	KEMA 99 ATEX 6971 X
110-113	HSK-M-PVDF-Ex	1.660.*	-20 °C–130 °C	x	x	KEMA 99 ATEX 6971 X
116	HSK-MZ-PVDF-Ex	1.661.*	-20 °C–130 °C	x	x	KEMA 99 ATEX 6971 X
117	HSK-INOX-PVDF-Ex	1.662.*	-20 °C–130 °C	x	x	KEMA 99 ATEX 6971 X
125	HSK-M-EMC-PVDF-Ex	1.666.*	-20 °C–130 °C	x	x	KEMA 99 ATEX 6971 X
127	HSK-MZ-EMC-PVDF-Ex	1.667.*	-20 °C–130 °C	x	x	KEMA 99 ATEX 6971 X
114	HSK-M-Multi-Ex	1.687.*	-20 °C–95 °C	x	x	DMT 03 ATEX E 051 X
115	HSK-M-Flaka-Ex	1.689.*	-20 °C–95 °C	x	x	DMT 03 ATEX E 051 X
134, 139	V-MS-Ex d / INOX-Ex d	1.875.* / 1.895.*	-20 °C–95 °C	x	x	KEMA 06 ATEX 0024
134, 139	V-MS-Ex d / INOX-FKM-Ex d	1.876.* / 1.896.*	-20 °C–180 °C	x	x	KEMA 06 ATEX 0024
134, 139	V-MS-Ex d / INOX-VMQ-Ex d	1.877.* / 1.897.*	-60 °C–180 °C	x	x	KEMA 06 ATEX 0024
135, 140	RSD-MS-Ex d / INOX-Ex d	1.878.* / 1.898.*	-20 °C–95 °C	x	x	KEMA 06 ATEX 0024
135, 140	RSD-MS-Ex d / INOX-Ex d	1.879.* / 1.899.*	-60 °C–180 °C	x	x	KEMA 06 ATEX 0024

International Protection, EN 60529

1. Code		2. Code	Penetration of water											
Protection against human access to hazardous parts	Protection of equipment against penetration of solid foreign objects		IP x0	IP x1	IP x2	IP x3	IP x4	IP x5	IP x6	IP x7	IP x8			
Non-protected	Non-protected	IP 0x	IP 00											
Protected against access to hazardous parts with the back of the hand	Protected against solid foreign objects larger in diameter than 50 mm	IP 1x	IP 10	IP 11	IP 12									
Protected against access to hazardous parts with a finger	Protected against solid foreign object larger in diameter than 12,5 mm	IP 2x	IP 20	IP 21	IP 22	IP 23								
Protected against access to hazardous parts with a tool larger in diameter than 25 mm	Protected against solid foreign objects larger in diameter than 2,5 mm	IP 3x	IP 30	IP 31	IP 32	IP 33	IP 34							
Protected against access to hazardous parts with a wire larger in diameter than 1,0 mm	Protected against solid foreign objects larger in diameter than 1 mm	IP 4x	IP 40	IP 41	IP 42	IP 43	IP 44							
Protected against access to hazardous parts with a wire larger in diameter than 1,0 mm	Prevents penetration of dust sufficient to cause damage inside the equipment	IP 5x	IP 50				IP 54	IP 55						
Protected against access to hazardous parts with a wire larger in diameter than 1,0 mm	Dust proof	IP 6x	IP 60					IP 65	IP 66	IP 67	IP 68			

Product Material Abbreviations

CR	Chloroprene rubber
FKM	Fluorelastomer
Ms	Nickel plated brass
NBR	Buna-N
PA	Polyamide
PE	Polyethylene
PP	Polypropylene
PVC	Polyvinylchloride
PVDF	Polyvinylidenfluoride
VMQ	Silicone

Installation Instructions

Multi hole inserts: Cable diameter should not be less than 20 % of hole diameter and the difference between cable diameter and hole should never exceed 1 mm (.04").

Flat cable inserts: The clamping range of the cable used may not deviate from the manufacturer-specified minimum values by more than 1 mm in length and 1 mm in width. The geometries of the cable and the insert hole must be compatible (semicircular or straight at the sides).

Fire protection classes according UL94:

V0: burning stops within 10 seconds, drips of particles allowed as long as they are not inflamed, maximum afterglow 30 seconds
 V1: burning stops within 30 seconds, drips of particles allowed as long as they are not inflamed, maximum afterglow 60 seconds
 V2: burning stops within 30 seconds, drips of flaming particles are allowed

Metric ISO Thread Specifications

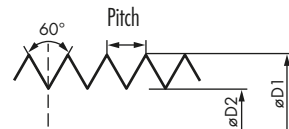

Size	Pitch mm	Outside-Ø D1 mm	Inside-Ø D2 mm	Through hole mm
M 12 x 1,5	1,5	12	10,38	12,2
M 16 x 1,5	1,5	16	14,38	16,2
M 20 x 1,5	1,5	20	18,38	20,2
M 25 x 1,5	1,5	25	23,38	25,2
M 32 x 1,5	1,5	32	30,38	32,2
M 40 x 1,5	1,5	40	38,38	40,2
M 50 x 1,5	1,5	50	48,38	50,2
M 63 x 1,5	1,5	63	61,38	63,2

PG Thread Specifications

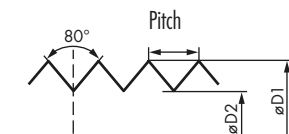

Size	Pitch mm	Outside-Ø D1 mm	Inside-Ø D2 mm	Through hole mm
PG 7	1,270	12,5	11,28	12,7
PG 9	1,410	15,2	13,86	15,4
PG 11	1,410	18,6	17,26	18,8
PG 13,5	1,410	20,4	19,06	20,7
PG 16	1,410	22,5	21,16	22,8
PG 21	1,588	28,3	26,78	28,6
PG 29	1,588	37,0	35,48	37,4
PG 36	1,588	47,0	45,48	47,5
PG 42	1,588	54,0	52,48	54,5
PG 48	1,588	59,3	57,78	59,8

NPT Thread Specifications

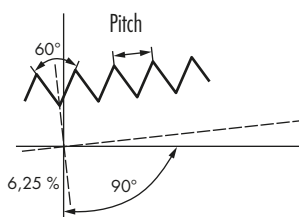

Size	Pitch mm	Outside-Ø mm	Number of pitches n
1/4" NPT	1,411	13,716	18
3/8" NPT	1,411	17,145	18
1/2" NPT	1,814	21,336	14
3/4" NPT	1,814	26,67	14
1" NPT	2,208	33,4	11 1/2
1 1/4" NPT	2,208	42,164	11 1/2
1 1/2" NPT	2,208	48,26	11 1/2
2" NPT	2,208	60,325	11 1/2
2 1/2" NPT	3,175	73,025	8
3" NPT	3,175	88,9	8
3 1/2" NPT	3,175	101,6	8

British G Thread Specifications

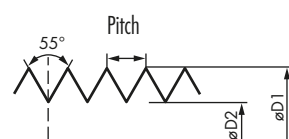

Size	Pitch mm	Outside-Ø D1 mm	Inside-Ø D2 mm	Through hole mm
G 1/4"	1,337	13,157	11,445	13,4
G 3/8"	1,337	16,662	14,950	17,0
G 1/2"	1,814	20,955	18,631	21,3
G 5/8"	1,814	26,441	24,117	26,8
G 1"	2,309	33,249	30,291	33,7
G 1 1/4"	2,309	41,910	38,952	42,4
G 1 1/2"	2,309	47,803	44,845	48,3
G 2"	2,309	59,614	56,656	60,2
G 2 1/2"	2,309	75,184	72,226	75,7
G 3"	2,309	87,884	84,926	88,5
G 3 1/2"	2,309	100,330	97,372	101,0
G 4"	2,309	113,030	110,072	114,0

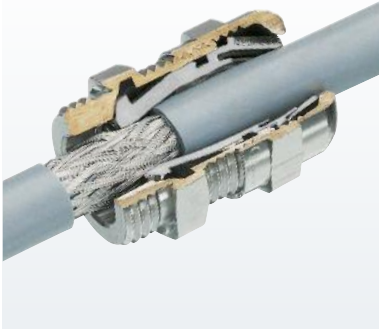

Option 1 – Feed-through of cable and shield (braided or foil)

- // Expose shield approximately 7/16" (10 mm)
- // Insert cable into fitting until the shield reaches the contact position
- // Tighten dome nut



Option 2 – Feed-through of shield (braided or foil)

- // Remove cable jacket to expose the shield as required
- // Insert cable into fitting until the shield reaches the contact position
- // Tighten dome nut



Option 3 – Termination of the braided shield in the fitting

- // Strip cable jacket and braided shield to different lengths
- // For small diameter cables fold the braided shield back over the cable jacket
- // Insert cable into fitting until the shield reaches the contact position
- // Tighten dome nut

HSK-M-EMC



Step 1

- // Strip cable
- // Expose braided shield



Step 2

- // Feed cable through dome nut and clamping insert
- // Fold braided shield over clamping insert
- // Make sure that braided shield overlaps the O-Ring by 3/32" (2 mm)



Step 3

- // Push clamping insert into body and tighten dome nut
- // Assemble into housing
- // Finished!

Numerical Index

Productnumber	Description	Page	Productnumber	Description	Page	Productnumber	Description	Page
1.022	Earthtag	150	1.251	V-N-FS	75	1.633	HSK-INOX-PVDF-Ex d	120
1.033	E-Ms	96	1.255	V-NE	76	1.634	HSK-M-PVDF-Ex d	118
1.039	RE-Ms	95	1.256	V-NE-SD	76	1.636	HSK-M-EMC-D-Ex	122-123
1.052	V-N-Ms	91	1.262	GM-FS	74	1.637	HSK-M-EMC-D-Ex	122-123
1.052	V-N-Ms-SD	91	1.263	GM-KS	83	1.640	HSK-M-Ex	110-113
1.071	R-H	93	1.272	R-FS	79	1.641	HSK-MZ-Ex	116
1.076	R-H	93	1.273	R-M-PA	80	1.642	HSK-INOX-Ex	117
1.077	RSD-Ms	94	1.280	HSK-V	78	1.646	HSK-M-EMC-Ex	124-125
1.078	RSD-Ms-Ex	133	1.282	WN	77	1.647	HSK-MZ-EMC-Ex	126-127
1.079	RSD-Ms-Ex	133	1.292	HSK-K-Ex-Active	104-105	1.660	HSK-M-PVDF-Ex	110-113
1.089	HSK-ME	86	1.293	HSK-K-Flex	24-25	1.661	HSK-MZ-PVDF-Ex	116
1.091	HSK-Flaka	87	1.294	HSK-K-Flex	24	1.662	HSK-INOX-PVDF-Ex	117
1.094	RS-INOX	101-102	1.296	HSK-V-Ex	131	1.666	HSK-M-EMC-PVDF-Ex	125
1.097	RSD-INOX	101-102	1.296	HSK-V-Ex MZ version	131	1.667	HSK-MZ-EMC-PVDF-Ex	127
1.098	RSD-INOX-Ex	137-138	1.297	V-Ex	130	1.669	HSK-MZ-PVDF	43-44
1.099	RSD-INOX-Ex	137-138	1.299	HSK-K-PVDF	21-23	1.673	HSK-INOX-EMC-Ex	128
1.101	DIN 46320-C4-Ms	69	1.306	FW-T	85	1.675	HSK-INOX	47-49
1.105	Z	70-71	1.306	FW-ZN	98	1.676	HSK-INOX-PVDF	47-48
1.106	GM-Ms	90	1.309	HSK-M-W	42	1.680	SE	72
1.106	HSK-Mini	45	1.312	KF-G	84	1.681	ZSE	72
1.106	HSK-XL	46	1.313	HSK-W	26-27	1.687	HSK-M-Multi-Ex	114
1.106	WADI-A-FKM	50	1.314	HSK-W-Flex	28	1.688	HSK-M-Flaka	38
1.112	HSK-Mini	45	1.315	90° Snap Elbow	82	1.689	HSK-M-Flaka-Ex	115
1.119	HSK-Mini-EMC	45	1.316	90° Snap Elbow	82	1.690	HSK-MZ	43-44
1.129	HSK-Mini-INOX	45	1.317	HSK-W rotating version	27	1.691	HSK-M-EMC	55-56
1.143	KLE	97	1.321	O-Ringe	88	1.692	HSK-MZ-EMC	59
1.152	V-INOX-NBR	100	1.325	Thread Seal Ring	89	1.693	HSK-INOX-EMC	60
1.153	V-INOX-FKM	100	1.326	Thread Seal Ring	149	1.695	HSK-INOX	47-48
1.154	V-INOX-VMQ	100	1.329	Serrated Washer	150	1.696	HSK-INOX-PVDF	47-48
1.155	V-NE-Ms	92	1.581	HSK-K-Multi-Ex-Active	106	1.697	HSK-M-Multi	37
1.156	V-NE-Ms-SD	92	1.582	HSK-K-Flaka-Ex-Active	107	1.698	HSK-M-PVDF-EMC	55-56
1.157	V-NE-Ms-SD-FKM	92	1.587	HSK-K-Flaka	20	1.699	HSK-M-PVDF	32-36
1.161	GM-Ms	90	1.590	HSK-KE	29	1.675	EXIOS MZ	144-145
1.161	GM-INOX	99	1.591	HSK-KR	30	1.740	HSK-INOX-HD	65
1.167	GM-EMC	90	1.597	HSK-K-Multi	19	1.740	HSK-INOX-HD-Pro	66
1.171	RE-Ms	95	1.605	EXIOS Standard	142-143	1.750	VariaPro Rail	62
1.192	V-INOX-Ex	136	1.606	EXIOS Barrier	146-147	1.751	VariaPro Temp	63
1.193	V-INOX-Ex	136	1.607	METRICA-M-EMC-E	54	1.752	VariaPro FKM	64
1.194	V-INOX-Ex	136	1.608	EXIOS A2F	148	1.802	PVC Shroud	149
1.197	V-Ms-Ex	132	1.609	HSK-M	32-36	1.875	V-Ms-Ex d	134
1.198	V-Ms-FKM-Ex	132	1.610	HSK-M-Ex	110-113	1.876	V-Ms-Ex d	134
1.199	V-Ms-VMQ-Ex	132	1.611	HSK-MZ-Ex	116	1.877	V-Ms-Ex d	134
1.202	DIN 46320-A-FS	68	1.612	HSK-INOX-Ex	117	1.878	RSD-Ms-Ex d	135
1.209	HSK-K	14-18	1.616	HSK-M-EMC-Ex	124-125	1.879	RSD-Ms-Ex d	135
1.213	KS	83	1.617	HSK-MZ-EMC-Ex	126-127	1.895	V-INOX-Ex d	139
1.215	HSK-K-MZ-Ex	108	1.622	HSK-M-Ex-d	118	1.896	V-INOX-Ex d	139
1.219	HSK-K	14-15	1.623	HSK-M-Flex	39-41	1.897	V-INOX-Ex d	139
1.233	K-FS	81	1.624	HSK-M-Flex-EMC	57-58	1.898	RSD-INOX-Ex d	140
1.236	R-FS	79	1.628	HSK-MZ-Ex d	119	1.899	RSD-INOX-Ex d	140
1.239	E-M-PA	81	1.631	HSK-M-EMC-D	52-53			
1.250	DS	77	1.632	HSK-INOX-Ex d	120			

Alphabetical Index

Productnumber	Description	Page	Productnumber	Description	Page	Productnumber	Description	Page
1.315	90° Snap Elbow	82	1.637	HSK-M-EMC-D-Ex	122-123	1.273	R-M-PA	80
1.316	90° Snap Elbow	82	1.616	HSK-M-EMC-Ex	124-125	1.039	RE-Ms	95
1.202	DIN 46320-A-FS	68	1.646	HSK-M-EMC-Ex	124-125	1.171	RE-Ms	95
1.101	DIN 46320-C4-Ms	69	1.666	HSK-M-EMC-PVDF-Ex	125	1.094	RS-INOX	101-102
1.250	DS	77	1.610	HSK-M-Ex	110-113	1.097	RSD-INOX	101-102
1.239	E-M-PA	81	1.640	HSK-M-Ex	110-113	1.098	RSD-INOX-Ex	137-138
1.033	E-Ms	96	1.622	HSK-M-Ex-d	118	1.099	RSD-INOX-Ex	137-138
1.022	Earthtag	150	1.688	HSK-M-Flaka	38	1.898	RSD-INOX-Ex d	140
1.608	EXIOS AZF	148	1.689	HSK-M-Flaka-Ex	115	1.899	RSD-INOX-Ex d	140
1.606	EXIOS Barrier	146-147	1.623	HSK-M-Flex	39-41	1.077	RSD-Ms	94
1.625	EXIOS MZ	144-145	1.624	HSK-M-Flex-EMC	57-58	1.078	RSD-Ms-Ex	133
1.605	EXIOS Standard	142-143	1.697	HSK-M-Multi	37	1.079	RSD-Ms-Ex	133
1.306	FW-T	85	1.687	HSK-M-Multi-Ex	114	1.878	RSD-Ms-Ex d	135
1.306	FW-ZN	98	1.699	HSK-M-PVDF	32-36	1.879	RSD-Ms-Ex d	135
1.167	GM-EMC	90	1.698	HSK-M-PVDF-EMC	55-56	1.680	SE	72
1.262	GM-FS	74	1.660	HSK-M-PVDF-Ex	110-113	1.329	Serrated Washer	150
1.161	GM-INOX	99	1.634	HSK-M-PVDF-Ex d	118	1.325	Thread Seal Ring	89
1.263	GM-KS	83	1.309	HSK-M-W	42	1.326	Thread Seal Ring	149
1.106	GM-Ms	90	1.089	HSK-ME	86	1.297	V-Ex	130
1.161	GM-Ms	90	1.106	HSK-Mini	45	1.192	V-INOX-Ex	136
1.091	HSK-Flaka	87	1.112	HSK-Mini	45	1.193	V-INOX-Ex	136
1.675	HSK-INOX	47-49	1.119	HSK-Mini-EMC	45	1.194	V-INOX-Ex	136
1.695	HSK-INOX	47-48	1.129	HSK-Mini-INOX	45	1.895	V-INOX-Ex d	139
1.693	HSK-INOX-EMC	60	1.690	HSK-MZ	43-44	1.896	V-INOX-Ex d	139
1.673	HSK-INOX-EMC-Ex	128	1.692	HSK-MZ-EMC	59	1.897	V-INOX-Ex d	139
1.612	HSK-INOX-Ex	117	1.617	HSK-MZ-EMC-Ex	126-127	1.153	V-INOX-FKM	100
1.642	HSK-INOX-Ex	117	1.647	HSK-MZ-EMC-Ex	126-127	1.152	V-INOX-NBR	100
1.632	HSK-INOX-Ex d	120	1.667	HSK-MZ-EMC-PVDF-Ex	127	1.154	V-INOX-VMQ	100
1.740	HSK-INOX-HD	65	1.611	HSK-MZ-Ex	116	1.197	V-Ms-Ex	132
1.740	HSK-INOX-HD-Pro	66	1.641	HSK-MZ-Ex	116	1.875	V-Ms-Ex d	134
1.676	HSK-INOX-PVDF	47-48	1.628	HSK-MZ-Ex d	119	1.876	V-Ms-Ex d	134
1.696	HSK-INOX-PVDF	47-48	1.669	HSK-MZ-PVDF	43-44	1.877	V-Ms-Ex d	134
1.662	HSK-INOX-PVDF-Ex	117	1.661	HSK-MZ-PVDF-Ex	116	1.198	V-Ms-FKM-Ex	132
1.633	HSK-INOX-PVDF-Ex d	120	1.280	HSK-V	78	1.199	V-Ms-VMQ-Ex	132
1.209	HSK-K	14-18	1.296	HSK-V-Ex	131	1.251	V-N-FS	75
1.219	HSK-K	14-15	1.296	HSK-V-Ex MZ version	131	1.052	V-N-Ms	91
1.292	HSK-K-Ex-Active	104-105	1.313	HSK-W	26-27	1.052	V-N-Ms-SD	91
1.587	HSK-K-Flaka	20	1.317	HSK-W rotating version	27	1.255	V-NE	76
1.582	HSK-K-Flaka-Ex-Active	107	1.314	HSK-W-Flex	28	1.155	V-NE-Ms	92
1.293	HSK-K-Flex	24-25	1.106	HSK-XL	46	1.156	V-NE-Ms-SD	92
1.294	HSK-K-Flex	24	1.233	K-FS	81	1.157	V-NE-Ms-SD-FKM	92
1.597	HSK-K-Multi	19	1.312	KF-G	84	1.256	V-NE-SD	76
1.581	HSK-K-Multi-Ex-Active	106	1.143	KLE	97	1.752	VariaPro FKM	64
1.215	HSK-K-MZ-Ex	108	1.213	KS	83	1.750	VariaPro Rail	62
1.299	HSK-K-PVDF	21-23	1.607	METRICA-M-EMC-E	54	1.751	VariaPro Temp	63
1.590	HSK-KE	29	1.321	O-Ringe	88	1.106	WADI-A-FKM	50
1.591	HSK-KR	30	1.802	PVC Shroud	149	1.282	WN	77
1.609	HSK-M	32-36	1.236	R-FS	79	1.105	Z	70-71
1.691	HSK-M-EMC	55-56	1.272	R-FS	79	1.681	ZSE	72
1.631	HSK-M-EMC-D	52-53	1.071	R-H	93			
1.636	HSK-M-EMC-D-Ex	122-123	1.076	R-H	93			



LIMITED LIABILITY / IMPRINT

Limited Liability

Products, design, colors and dimensions are subject to change without prior notice. We reserve the right to make technical improvements on all our products, currently ordered or for future orders. It is the users responsibility to verify all dimensions and technical data. HUMMEL AG will assume no liability regarding information provided to the user by published literature or inside technical staff, its distributors and outside sales personnel. Errors in the catalog can occur and shall not create any liability whatsoever for HUMMEL AG. All information provided by HUMMEL AG is without guarantee and must be verified by the user.

Imprint

Graphic & Layout:

HUMMEL AG, Marketing & Communications, Lise-Meitner-Str. 2, 79211 Denzlingen, Germany, Tel. +49 (0) 76 66 / 9 11 10-0, Fax +49 (0) 76 66 / 9 11 10-20, info@hummel.com

Printer:

Druckerei Furtwängler GmbH, 79211 Denzlingen, Germany, Tel. +49 (0) 76 66 / 13 31. Printed on recycled paper in February 2019.







Europe

HUMMEL France

HUMMEL CONNECTEURS SAS

ZI - Rue de l'Acqueline
51800 Sainte Ménéhould / France

Tel. +33 (0) 3 89 / 55 37 20
Fax +33 (0) 3 89 / 53 80 27
E-Mail info.fr@hummel.com
www.hummel.com

HUMMEL UK

HUMMEL UK Limited

Office 3, Momentum House
Enterprise Way, Lowton St Marys,
Warrington, Cheshire, WA3 2BP
United Kingdom

Tel. +44 (0) 19 42 / 60 56 95
Fax +44 (0) 19 42 / 26 93 24
E-Mail info.uk@hummel.com
www.hummel.com

HUMMEL Italy

HUMMEL S.r.l.

Via Enrico Fermi 61
10091 Alpignano (Torino) / Italy

Tel. +39 (0) 11 / 9 68 26 38
Fax +39 (0) 11 / 9 78 55 50
E-Mail info.it@hummel.com
www.hummel.com

HUMMEL Poland

HUMMEL Sales Office Poland

Al. 23 Stycznia 26 lok. 20
86-300 Grudziadz / Poland

Tel. +48 (0) 6 62 / 38 27 99
Fax +48 (0) 56 / 6 43 00 11
E-Mail info.pl@hummel.com
www.hummel.com

HUMMEL Russia

OOO HUMMEL

Ul. Retschnikov 21, Strojenije 1
115142 Moskau / Russia

Tel. +7 (0) 4 99 / 7 82 40 68
Fax +7 (0) 4 99 / 6 14 67 40
E-Mail info.ru@hummel.com
www.hummel-russia.ru

HUMMEL Scandinavia

HUMMEL Connector Systems AB

Tel. +46 (0) 73 / 8 00 12 00
E-Mail info.se@hummel.com
www.hummel.com

Asia

HUMMEL China

HUMMEL Connector Systems (Shanghai) Co., Ltd.

Room 1701 Central Plaza
No.227 Huang Pi (N) Road
200003 Shanghai / P.R. China

Tel. +86 (0) 21 / 63 75 85 51
Fax +86 (0) 21 / 63 75 85 53
E-Mail info.hcs.cn@hummel.com
www.hummel.com

HUMMEL India

HUMMEL Connector Systems Price Limited

307, Surya Kiran Building
19 Kasturba Gandhi Marg
New Delhi - 110001 / India

Tel. +91 (0) 11 / 43 00 75-21 / -23
Fax +91 (0) 11 / 43 00 75-22
E-Mail info.in@hummel.com
www.hummel.com

HUMMEL South Korea

HUMMEL AG KOREA Co., Ltd.

#628 Ssangyong Platinum River
659, Olympic-ro, Gangdong-gu
Seoul, 05248 / Korea

Tel. +82 (0) 2 / 4 70 27 62
Fax +82 (0) 2 / 4 70 27 63
E-Mail info.kr@hummel.com
www.hummel.com

South America

HUMMEL Brazil

HUMMEL Connector Systems Ltda.

Rua Derville Gabriel Pereira, 280
Barro Preto - Centro Empresarial Tatui I
CEP 18280-614 - Tatui / SP / Brazil

Tel. +55 (0) 15 / 33 22 70 00
Fax +55 (0) 15 / 33 22 70 26
E-Mail vendas@hummel.com.br
www.hummel.com.br



HUMMEL INTERNATIONAL



ELECTRIC COMPONENTS

Cable Glands

Polyamide-, Brass- and Stainless steel,
EMC-connections, Protection Ex e, Ex d, Ex ta



Circular Connectors

M 8 to M 40, INOX, TWILOCK, Industrial Ethernet,
Power, Signal, Hybrid-Connector, Moulded Cordsets



Conduit Systems

Corrugated Conduit Systems, Conduit Cable Glands, Angled Systems,
combined Cable Glands, Accessories



Cable Assembly

Moulded Signal- and Power Circular Connectors,
Servo Cables, Cable Sets



www.hummel.com



HUMMEL AG
Lise-Meitner-Straße 2
79211 Denzlingen
Germany
www.hummel.com

Tel. +49 (0) 76 66 / 9 11 10-0
Fax +49 (0) 76 66 / 9 11 10-20
E-Mail info@hummel.com



X-ON Electronics

Largest Supplier of Electrical and Electronic Components

Click to view similar products for [Cable Glands, Strain Reliefs & Cord Grips](#) category:

Click to view products by [Hummel](#) manufacturer:

Other Similar products are found below :

[1218](#) [1300980012](#) [1300980105](#) [DBZM-6828](#) [1498](#) [915](#) [300623](#) [5632NM](#) [1124](#) [1151](#) [561-MP6P4WH](#) [5534M](#) [5525](#) [9000005073](#) [5315817](#)
[N16 025 0112 1](#) [N16 020 0112 1](#) [M6106](#) [7422](#) [NG-9516 Gasket](#) [N16 016 0112 1](#) [NG-9514 Gasket](#) [52006151](#) [2704](#) [BM4940L](#) [BM4950L](#)
[1.209.1218.70](#) [1.209.2101.14](#) [1.209.2901.14](#) [1.209.6400.70](#) [1.209.6400.71](#) [1.262.4200.11](#) [52015760](#) [52103150](#) [53119073](#) [54115405](#)
[52004120](#) [APGPG36BA](#) [1300990004](#) [G-INS-PG9-M68N-PNES-BK](#) [G-INS-M16-T68N-PNES-BK](#) [G-INS-M20-M68N-PNES-BK](#) [G-INS-](#)
[M25-S68N-NNES-S](#) [1.089.0902.19](#) [1.089.0904.19](#) [1.089.0999.19](#) [1.089.1102.19](#) [1.251.2900.11](#) [1.251.3601.11](#) [1.251.4000.50](#)