

参 数 表

350mA 系列高压高频二极管采用高可靠性的台面结构及扩散工艺，环氧树脂真空灌注密闭封装。

350mA Series High voltage rectifier diode adopts high reliable mesa structure and diffusion craftwork, epoxy resin molded in a compact structure.

▼ 产品特点 Feature

- ❖ 雪崩电压击穿保护特性 Avalanche Characteristic
- ❖ 优异的抗浪涌电流冲击特性 Excellent surge current resistance
- ❖ 高速开关响应特性 High speed switch response characteristics
- ❖ 采用新型环氧树脂真空封装技术，表面具有抗腐蚀性
Epoxy resin molded in vacuum, have anticorrosion in the surface
- ❖ 工作结温 -50°C — $+175^{\circ}\text{C}$ Tj: 50°C — $+175^{\circ}\text{C}$
- ❖ 特殊耐高温性能芯片，可承受严酷恶劣的使用条件
Special high temperature resistant chip that can withstand harsh working conditions.

▼ 产品 2D 图示

Graphical Representation



▼ 外形尺寸图示 Outline Drawings

(单位：毫米 mm)

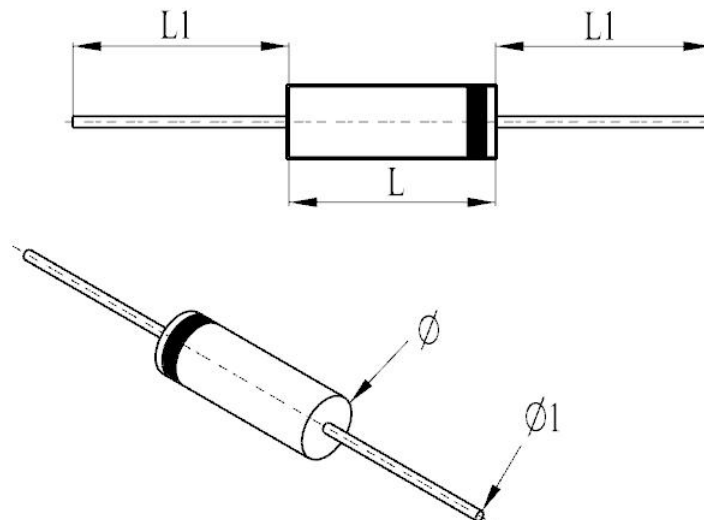

▼ 电气特性和绝对最大额定值
Electrical Characteristics and Absolute Maximum Ratings 4 ~ 60KV 350mA Trr=80~500nS

型号 NO.	反向工作 峰值电压 (Vrwm) KV	正向平均 整流电流 (If) mA	反向电流 @ Vrwm (Ir)		正向最大 峰值电压 (Vf) V	重复冲击 电流(Ifrm) A	反向恢复 时间 (Trr) nS	尺寸 (mm)
			25°C	100°C				
			μA	μA				
2CL9KV-350mA	9	350	2.0	20.0	10	25	--	Φ4.5*15/Φ7.5*22
2CL10KV-350mA	10	350	2.0	20.0	11	25	--	Φ4.5*15/Φ7.5*22
2CL12KV-350mA	12	350	2.0	20.0	13	25	--	Φ4.5*15/Φ7.5*22
2CL15KV-350mA	15	350	2.0	20.0	16	25	--	Φ4.5*15/Φ7.5*22
2CL18KV-350mA	18	350	2.0	20.0	20	25	--	Φ8*25/Φ8*40
2CL20KV-350mA	20	350	2.0	20.0	24	25	--	Φ8*25/Φ8*40
2CL30KV-350mA	30	350	2.0	20.0	35	25	--	Φ8*40/Φ8*60
2CL40KV-350mA	40	350	2.0	20.0	52	25	--	Φ8*40/Φ8*60
2CL50KV-350mA	50	350	2.0	20.0	58	25	--	Φ8*60/Φ8*80
2CL60KV-350mA	60	350	2.0	20.0	65	25	--	Φ8*80/80*8*8
2CLG8KV-350mA	8	350	2.0	20.0	16	20	100	Φ4.5*15
2CLG10KV-350mA	10	350	2.0	20.0	18	20	100	Φ4.5*15
2CLG12KV-350mA	12	350	2.0	20.0	22	20	100	Φ4.5*15
2CLG15KV-350mA	15	350	2.0	20.0	26	20	100	Φ4.5*15
2CLG18KV-350mA	18	350	2.0	20.0	30	20	100	Φ4.5*15
2CLG20KV-350mA	20	350	2.0	20.0	35	20	100	Φ4.5*15
2CLG30KV-350mA	30	350	2.0	20.0	45	20	100	Φ4.5*15/Φ8*40
2CLG35KV-350mA	35	350	2.0	20.0	50	20	100	Φ8*40/Φ8*60

2CLG40KV-350mA	40	350	2.0	20.0	58	20	100	Φ8*60/Φ8*80
2CLG50KV-350mA	50	350	2.0	20.0	65	20	100	Φ8*60/Φ8*80
2CLG60KV-350mA	60	350	2.0	20.0	95	20	100	Φ8*80/80*8*8

X-ON Electronics

Largest Supplier of Electrical and Electronic Components

Click to view similar products for [Diodes - General Purpose, Power, Switching category](#):

Click to view products by [HVDIODE manufacturer](#):

Other Similar products are found below :

[MCL4151-TR3](#) [MMBD3004S-13-F](#) [RD0306T-H](#) [RGP30G-E373](#) [BAQ333-TR](#) [BAQ335-TR](#) [BAQ33-GS18](#) [BAS1602VH6327XT](#) [BAV17-TR](#) [BAV19-TR](#) [BAV301-TR](#) [BAW27-TAP](#) [NSVBAV23CLT1G](#) [NTE525](#) [1SS181-TP](#) [1SS184-TP](#) [1SS193,LF](#) [1SS193-TP](#) [1SS400CST2RA](#) [SBAV99LT3G](#) [SDAA13](#) [LL4448-GS18](#) [SHN2D02FUTW1T1G](#) [LS4150GS18](#) [LS4151GS08](#) [SMMBD7000LT3G](#) [1N4449](#) [1N4934-E3/73](#) [APT100DL60HJ](#) [RFUH20TB3S](#) [RGP30G-E354](#) [RGP30M-E3/73](#) [D291S45T](#) [MCL4151-TR](#) [BAS 16-02L E6327](#) [BAS 16-02V H6327](#) [BAS 21U E6327](#) [BAS 28 E6327](#) [BAS33-TAP](#) [BAS 70-02V H6327](#) [BAV300-TR](#) [BAV303-TR3](#) [BAW27-TR](#) [BAW56DWQ-7-F](#) [BAW56M3T5G](#) [BAW75-TAP](#) [BAW76-TR](#) [MM230L-CAA](#) [MMSD914-TP](#) [IDW40E65D1](#)