

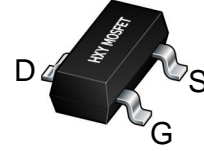

Description

The BSS215PH6327XTSA1 uses advanced trench technology to provide excellent $R_{DS(ON)}$, low gate charge and operation with gate voltages as low as 1.8V. This device is suitable for use as a load switch or in PWM applications.



SOT-23

General Features

$$V_{DS} = -20V, I_D = -2.3A$$

$$R_{DS(ON)} < 115m\Omega @ V_{GS} = -4.5V$$

$$R_{DS(ON)} < 152m\Omega @ V_{GS} = -2.5V$$

Application

PWM applications

Load switch

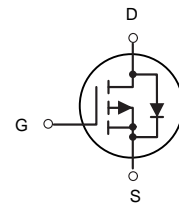

P-Channel MOSFET

Package Marking and Ordering Information

| Product ID | Pack | Brand | Qty(PCS) |
|-------------------|--------|------------|----------|
| BSS215PH6327XTSA1 | SOT-23 | HXY MOSFET | 3000 |

Absolute Maximum Ratings (TA=25°C unless otherwise noted)

| Symbol | Parameter | Limit | Unit |
|-----------------|--|------------|------|
| V_{DS} | Drain-Source Voltage | -20 | V |
| V_{GS} | Gate-Source Voltage | ± 12 | V |
| I_D | Drain Current-Continuous | -2.3 | A |
| I_{DM} | Drain Current-Pulsed (Note 1) | -10 | A |
| P_D | Maximum Power Dissipation | 0.7 | W |
| T_J, T_{STG} | Operating Junction and Storage Temperature Range | -55 To 150 | °C |
| $R_{\theta JA}$ | Thermal Resistance, Junction-to-Ambient (Note 2) | 178 | °C/W |



Electrical Characteristics ($T_A=25^{\circ}\text{C}$ unless otherwise noted)

| Parameter | Symbol | Condition | Min | Typ | Max | Unit |
|---|--------------|---|------|------|-----------|------------|
| Off Characteristics | | | | | | |
| Drain-Source Breakdown Voltage | BV_{DSS} | $V_{GS}=0V, I_D=-250\mu A$ | -20 | | - | V |
| Zero Gate Voltage Drain Current | I_{DSS} | $V_{DS}=-20V, V_{GS}=0V$ | - | - | -1 | μA |
| Gate-Body Leakage Current | I_{GSS} | $V_{GS}=\pm 12V, V_{DS}=0V$ | - | - | ± 100 | nA |
| On Characteristics (Note 3) | | | | | | |
| Gate Threshold Voltage | $V_{GS(th)}$ | $V_{DS}=V_{GS}, I_D=-250\mu A$ | -0.4 | -0.7 | -1 | V |
| Drain-Source On-State Resistance | $R_{DS(on)}$ | $V_{GS}=-4.5V, I_D=-2A$ | | 95 | 115 | m Ω |
| | | $V_{GS}=-2.5V, I_D=-1.8A$ | | 125 | 152 | m Ω |
| Forward Transconductance | g_{FS} | $V_{DS}=-5V, I_D=-2A$ | 4 | - | - | S |
| Dynamic Characteristics (Note4) | | | | | | |
| Input Capacitance | C_{iss} | $V_{DS}=-10V, V_{GS}=0V,$ $F=1.0\text{MHz}$ | - | 285 | - | PF |
| Output Capacitance | C_{oss} | | - | 58 | - | PF |
| Reverse Transfer Capacitance | C_{rss} | | - | 32 | - | PF |
| Switching Characteristics (Note 4) | | | | | | |
| Turn-on Delay Time | $t_{d(on)}$ | $V_{DD}=-10V, R_L=5\Omega$ $V_{GS}=-4.5V, R_{GEN}=3\Omega$ | - | 9.8 | - | nS |
| Turn-on Rise Time | t_r | | - | 4.9 | - | nS |
| Turn-Off Delay Time | $t_{d(off)}$ | | - | 20.5 | - | nS |
| Turn-Off Fall Time | t_f | | - | 7 | - | nS |
| Total Gate Charge | Q_g | $V_{DS}=-10V, I_D=-2A,$ $V_{GS}=-4.5V$ | - | 2.9 | - | nC |
| Gate-Source Charge | Q_{gs} | | - | 0.45 | - | nC |
| Gate-Drain Charge | Q_{gd} | | - | 0.75 | - | nC |
| Drain-Source Diode Characteristics | | | | | | |
| Diode Forward Voltage (Note 3) | V_{SD} | $V_{GS}=0V, I_S=-2A$ | - | - | -1.2 | V |
| Diode Forward Current (Note 2) | I_S | | - | - | -2.0 | A |

Notes:

1. Repetitive Rating: Pulse width limited by maximum junction temperature.
2. Surface Mounted on FR4 Board, $t \leq 10$ sec.
3. Pulse Test: Pulse Width $\leq 300\mu s$, Duty Cycle $\leq 2\%$.
4. Guaranteed by design, not subject to production



Typical Electrical and Thermal Characteristics

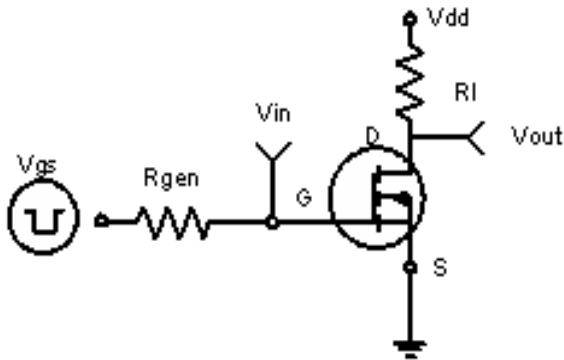

Figure 1: Switching Test Circuit

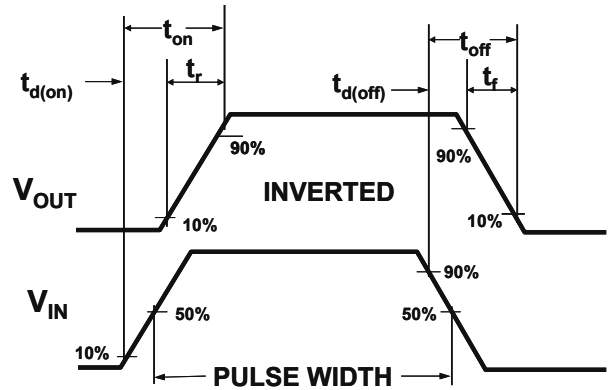

Figure 2: Switching Waveforms

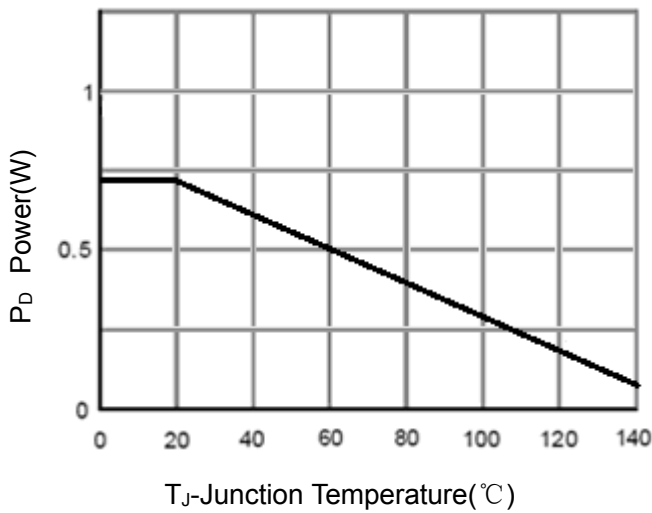

Figure 3 Power Dissipation

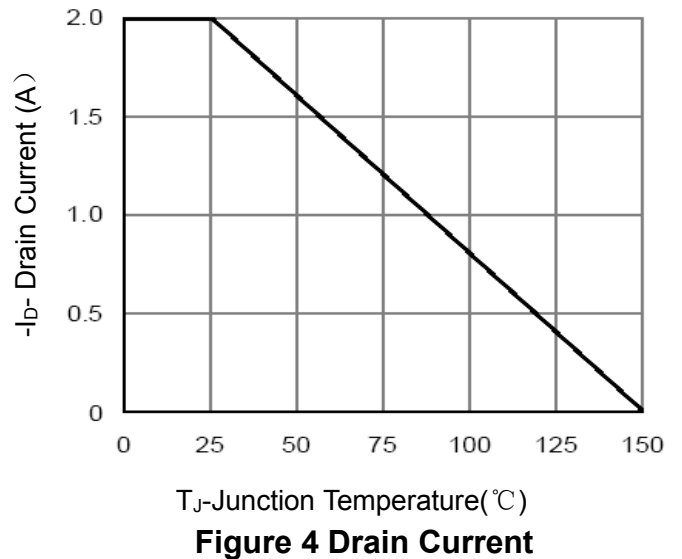

Figure 4 Drain Current

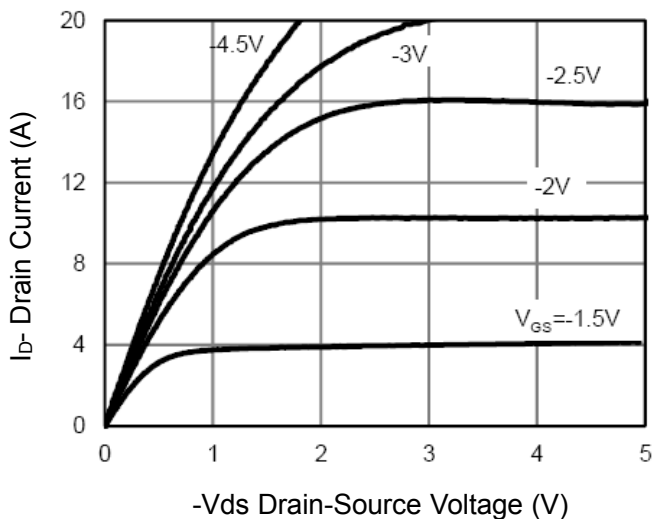

Figure 5 Output Characteristics

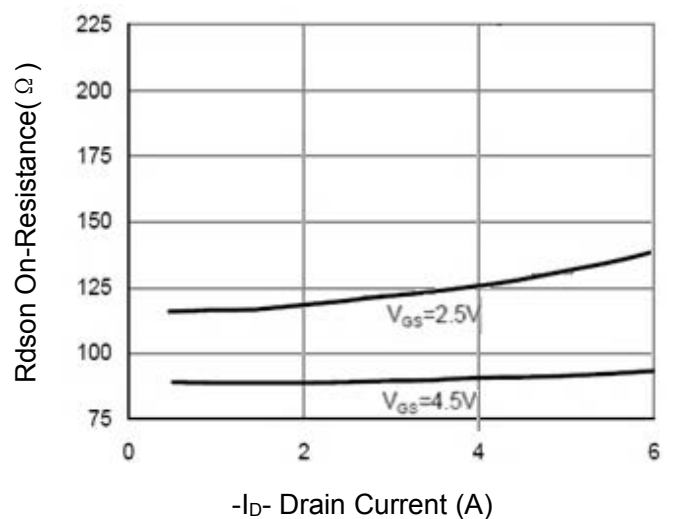

Figure 6 Drain-Source On-Resistance

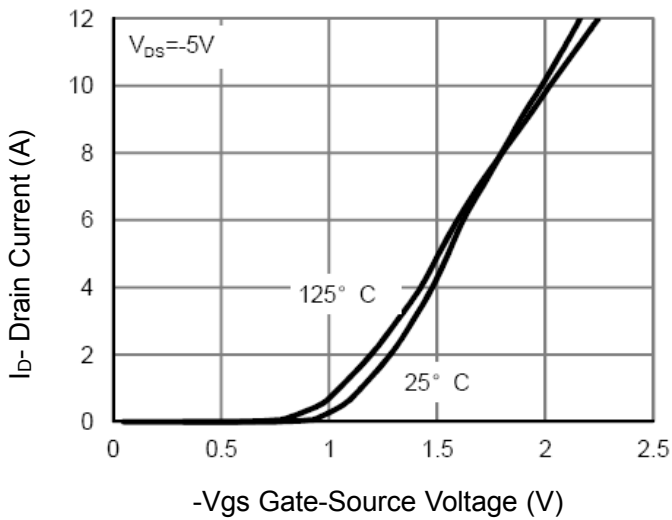

Figure 7 Transfer Characteristics

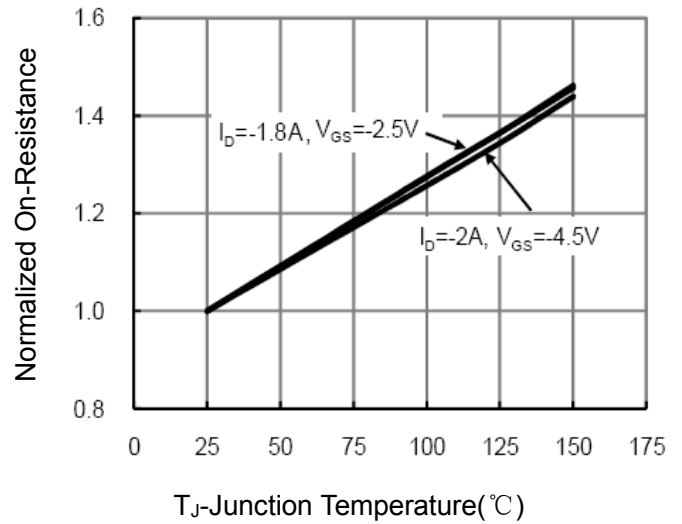

Figure 8 Drain-Source On-Resistance

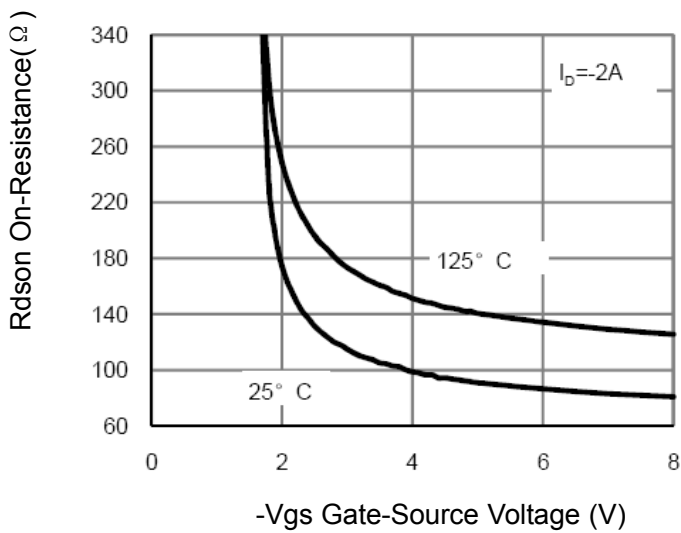

Figure 9 Rdson vs Vgs

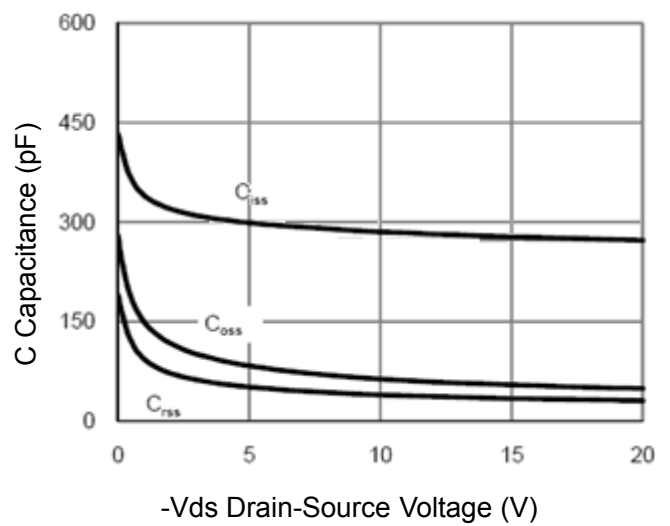

Figure 10 Capacitance vs Vds

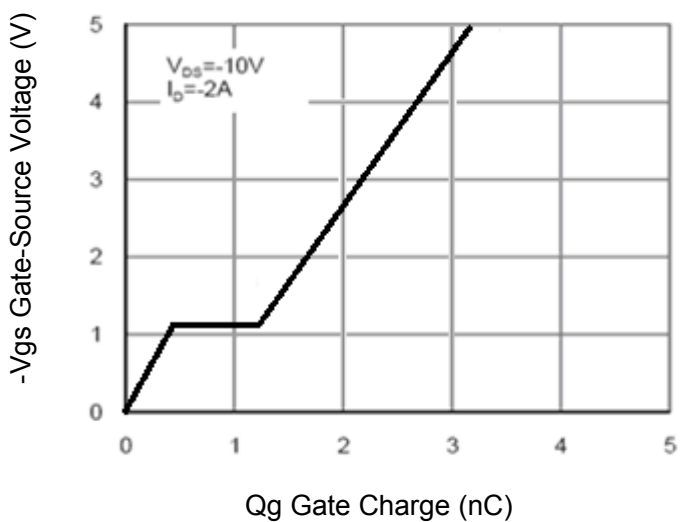

Figure 11 Gate Charge

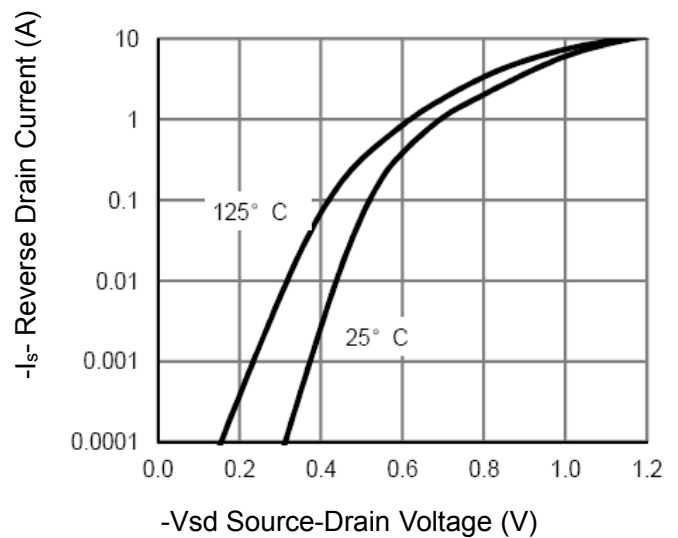

Figure 12 Source- Drain Diode Forward

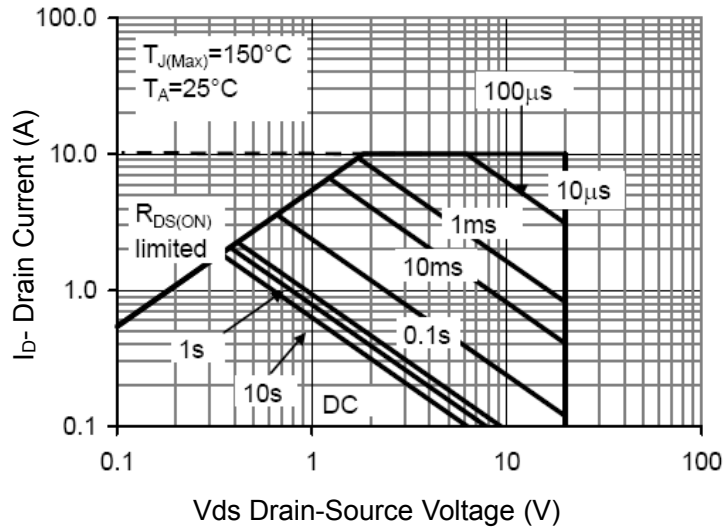

Figure 13 Safe Operation Area

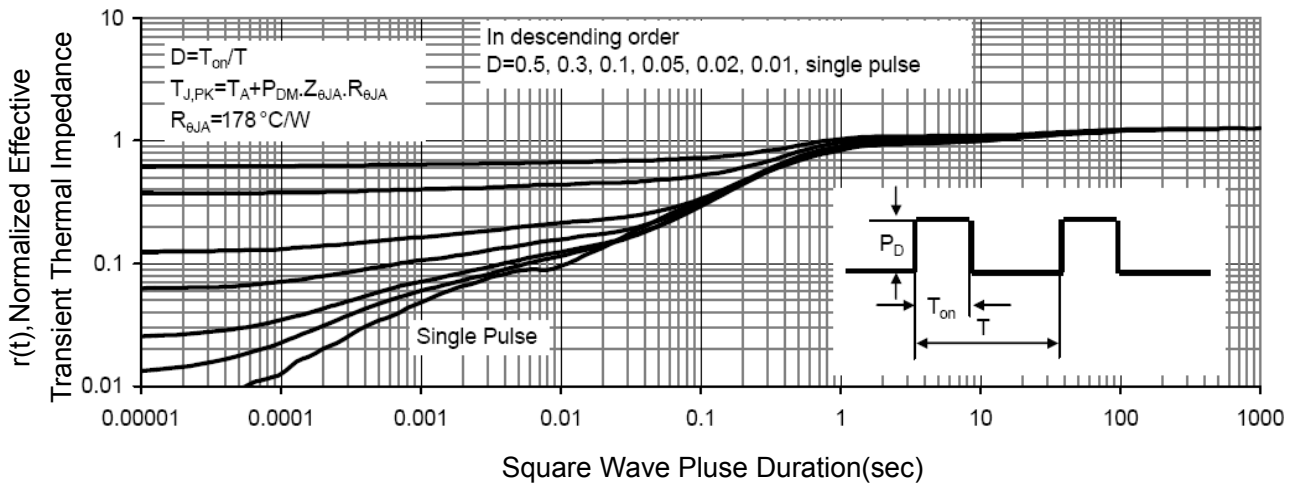
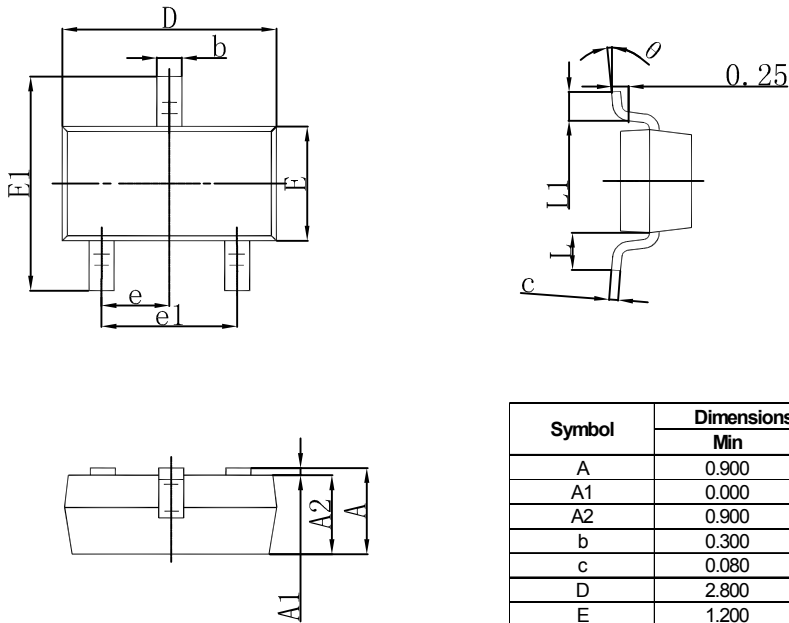

Figure 14 Normalized Maximum Transient Thermal Impedance



SOT-23 Package Outline Dimensions



| Symbol | Dimensions In Millimeters | | Dimensions In Inches | |
|--------|---------------------------|-------|----------------------|-------|
| | Min | Max | Min | Max |
| A | 0.900 | 1.150 | 0.035 | 0.045 |
| A1 | 0.000 | 0.100 | 0.000 | 0.004 |
| A2 | 0.900 | 1.050 | 0.035 | 0.041 |
| b | 0.300 | 0.500 | 0.012 | 0.020 |
| c | 0.080 | 0.150 | 0.003 | 0.006 |
| D | 2.800 | 3.000 | 0.110 | 0.118 |
| E | 1.200 | 1.400 | 0.047 | 0.055 |
| E1 | 2.250 | 2.550 | 0.089 | 0.100 |
| e | 0.950 TYP | | 0.037 TYP | |
| e1 | 1.800 | 2.000 | 0.071 | 0.079 |
| L | 0.550 REF | | 0.022 REF | |
| L1 | 0.300 | 0.500 | 0.012 | 0.020 |
| theta | 0° | 8° | 0° | 8° |

SOT-23 Suggested Pad Layout

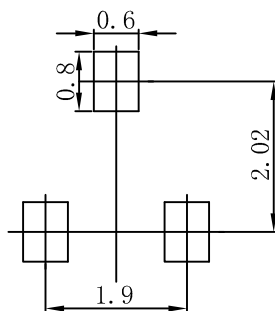

- Note:
1. Controlling dimension: in millimeters.
 2. General tolerance: ± 0.05 mm.
 3. The pad layout is for reference purposes only.



Attention

- Any and all HUA XUAN YANG ELECTRONICS products described or contained herein do not have specifications that can handle applications that require extremely high levels of reliability, such as life-support systems, aircraft's control systems, or other applications whose failure can be reasonably expected to result in serious physical and/or material damage. Consult with your HUA XUAN YANG ELECTRONICS representative nearest you before using any HUA XUAN YANG ELECTRONICS products described or contained herein in such applications.
- HUA XUAN YANG ELECTRONICS assumes no responsibility for equipment failures that result from using products at values that exceed, even momentarily, rated values (such as maximum ratings, operating condition ranges, or other parameters) listed in products specifications of any and all HUA XUAN YANG ELECTRONICS products described or contained herein.
- Specifications of any and all HUA XUAN YANG ELECTRONICS products described or contained herein stipulate the performance, characteristics, and functions of the described products in the independent state, and are not guarantees of the performance, characteristics, and functions of the described products as mounted in the customer's products or equipment. To verify symptoms and states that cannot be evaluated in an independent device, the customer should always evaluate and test devices mounted in the customer's products or equipment.
- HUA XUAN YANG ELECTRONICS CO.,LTD. strives to supply high-quality high-reliability products. However, any and all semiconductor products fail with some probability. It is possible that these probabilistic failures could give rise to accidents or events that could endanger human lives, that could give rise to smoke or fire, or that could cause damage to other property. When designing equipment, adopt safety measures so that these kinds of accidents or events cannot occur. Such measures include but are not limited to protective circuits and error prevention circuits for safe design, redundant design, and structural design.
- In the event that any or all HUA XUAN YANG ELECTRONICS products(including technical data, services) described or contained herein are controlled under any of applicable local export control laws and regulations, such products must not be exported without obtaining the export license from the authorities concerned in accordance with the above law.
- No part of this publication may be reproduced or transmitted in any form or by any means, electronic or mechanical, including photocopying and recording, or any information storage or retrieval system, or otherwise, without the prior written permission of HUA XUAN YANG ELECTRONICS CO.,LTD.
- Information (including circuit diagrams and circuit parameters) herein is for example only ; it is not guaranteed for volume production. HUA XUAN YANG ELECTRONICS believes information herein is accurate and reliable, but no guarantees are made or implied regarding its use or any infringements of intellectual property rights or other rights of third parties.
- Any and all information described or contained herein are subject to change without notice due to product/technology improvement, etc. When designing equipment, refer to the "Delivery Specification" for the HUA XUAN YANG ELECTRONICS product that you intend to use.

X-ON Electronics

Largest Supplier of Electrical and Electronic Components

Click to view similar products for [MOSFET](#) category:

Click to view products by [HXY MOS](#) manufacturer:

Other Similar products are found below :

[IRFD120](#) [JANTX2N5237](#) [BUK455-60A/B](#) [MIC4420CM-TR](#) [VN1206L](#) [NDP4060](#) [SI4482DY](#) [IPS70R2K0CEAKMA1](#) [SQD23N06-31L-GE3](#)
[TK16J60W,S1VQ\(O](#) [2SK2614\(TE16L1,Q\)](#) [DMN1017UCP3-7](#) [DMN1053UCP4-7](#) [SQJ469EP-T1-GE3](#) [NTE2384](#) [DMC2700UDMQ-7](#)
[DMN2080UCB4-7](#) [DMN61D9UWQ-13](#) [US6M2GTR](#) [DMN31D5UDJ-7](#) [DMP22D4UFO-7B](#) [DMN1006UCA6-7](#) [DMN16M9UCA6-7](#)
[STF5N65M6](#) [IRF40H233XTMA1](#) [STU5N65M6](#) [DMN6022SSD-13](#) [DMN13M9UCA6-7](#) [DMTH10H4M6SPS-13](#) [DMN2990UFB-7B](#)
[IPB80P04P405ATMA2](#) [2N7002W-G](#) [MCAC30N06Y-TP](#) [MCQ7328-TP](#) [BXP7N65D](#) [BXP4N65F](#) [AOL1454G](#) [WMJ80N60C4](#) [BXP2N20L](#)
[BXP2N65D](#) [BXT1150N10J](#) [BXT1700P06M](#) [TSM60NB380CP](#) [ROG](#) [RQ7L055BGTCR](#) [DMNH15H110SK3-13](#) [SLF10N65ABV2](#)
[BSO203SP](#) [BSO211P](#) [IPA60R230P6](#) [IPA60R460CE](#)