



## Description

HACS712ELCTR is a high-performance Hall effect current sensor that can more effectively measure AC(alternating current)or DC (direct current) current, and is widely used in industrial, consumer, and communication equipment.

The HACS712ELCTR series internally integrates a highly accurate and low-noise linear Hall circuit and a low impedance main current loop conductor. When the sampled current flows through the main current loop, the magnetic field it generates induces a corresponding electrical signal on the Hall circuit, which is then processed by the signal processing circuit to output a voltage signal, making the product output strictly proportional to the measured current value.

The linear Hall circuit is manufactured using advanced BCDMOS process, which includes a high sensitivity Hall sensor, a preamplifier for the Hall signal, a high precision Hall temperature compensation unit, an oscillator, a dynamic offset elimination circuit, and an output module for the amplifier. In the absence of a magnetic field, the static output of the current sensor is 50% VCC. Under a power supply voltage of 5V, the sensor's static output can linearly change between 0.2~4.8V with the magnetic field, with a linearity of up to 0.4%.

The dynamic offset elimination circuit integrated inside the HACS712ELCTR ensures that the sensitivity of the sensor is not affected by external pressure and IC packaging stress. The HACS712ELCTR is available in SOP-8 package, with an operating temperature range of -40~150°C, and complies with RoHS standards.

## Features

- Working voltage:4.5V~5.5V
- Static common mode output point:50%VCC
- Wide measuring range:5A/20A/30A
- Isolation voltage:2500V
- High bandwidth:120kHz
- Output response time:4μs(typical value)
- Stability within operating range:  
1.5% @ 25°C~150°C; 1% @-40°C~25°C
- Low-noise analog signal path
- Strong anti-interference ability
- Strong resistance to mechanical stress,  
magnetic field parameters are not shifted  
by external pressure
- ESD(HBM):5kV
- Operating temperature:-40°C~150°C
- Proportional output, bidirectional current

## Application scope

- Inverter current detection
- Motor phase current detection  
(motor control)
- Photovoltaic inverter
- Battery Load Testing System
- Current Transformer
- Switching Power Supply
- Overload Protection Device



## Order Information

Product Model	Package Type	Packing	Packing Qty
HACS712ELCTR-05B-T	SOP-8	Tape	3000PCS/Reel
HACS712ELCTR-20A-T	SOP-8	Tape	3000PCS/Reel
HACS712ELCTR-30A-T	SOP-8	Tape	3000PCS/Reel

## Functional Block Diagram

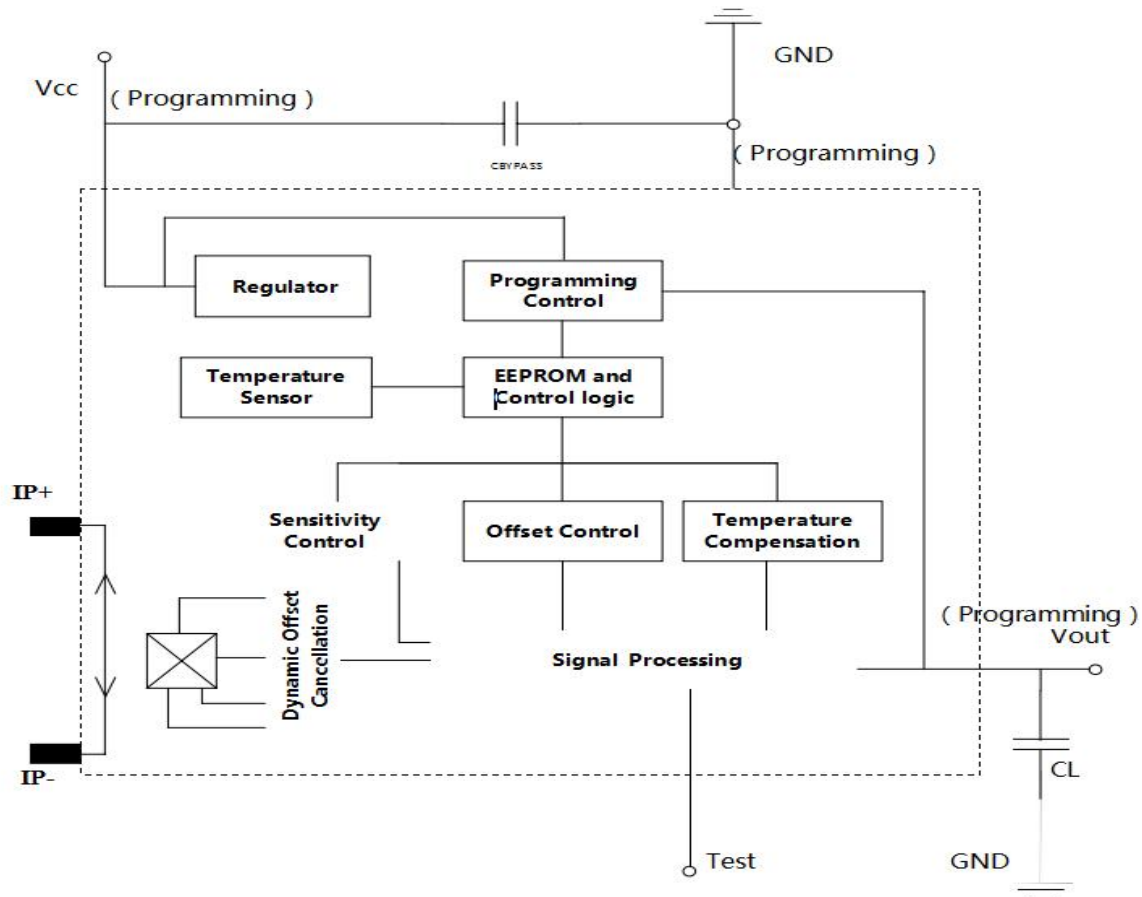

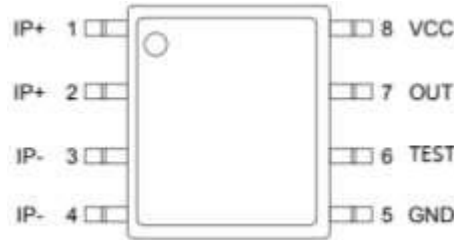

## Pin Information

Name	Number	Function	Name	Number	Function
IP+	1	Positive current input terminal	GND	5	Ground/Programming Pin
IP+	2	Positive current input terminal	TEST	6	Factory Testing/Floating
IP-	3	Negative current input terminal	OUT	7	Signal Output/Programming Pin
IP-	4	Negative current input terminal	VCC	8	Power Supply/Programming Pin

## Limiting Parameter

Using the device beyond its limiting parameters may cause instability of the chip's functions, and prolonged exposure to such conditions may damage the chip.

Symbol	Parameter	Min	Max	Unit
VCC	Power supply voltage	-	6	V
VOUT	Output voltage	-	VCC-0.5	V
IOUT(source)	Output current source	-	80	mA
IOUT(sink)	Output current sink	-	40	mA
TA	Working Environment Temperature	-40	150	°C
TS	Storage Temperature	-65	170	°C
TJ	Maximum Junction Temperature	-	165	°C
Endurance	EEPROM Programming cycle number	200	-	cycle
Transient surge current at current sampling terminal	IP1pulse100ms		100	A

## Electrostatic Discharge(ESD) parameters

Symbol	Execution Standard	Max	Unit	
VESD	Human Body Model (HBM)	JEDECJS-001-2017	5	kV



## Electrical parameters

Symbol	Parameter	Test conditions	Min	Typ	Max	Unit
VCC	Operating voltage		4.5	5	5.5	V
ICC	Operating current	TA=25°C, Output NoLoad	9	11.18	13	mA
BW	Built-in bandwidth	Smallsignal: -3dB, CL=1nF, TA=25°C		120		KHz
TPO	Power-on time	TA=25°C, CL=1nF, Sensitivity 2mV/G, ConstantMagneticField 400Gs		100		us
TTC	Positive current input terminal Temperature-compensated power-on time	TA=150°C, CL=1nF, Sensitivity 2mV/G, Constant Magnetic Field:400 Gs		300		us
VUVLOH	Undervoltage lockout threshold	TA=25°C, Voltagerises, Devicestarts operating.		4.1		V
VUVLOL		TA=25°C, Voltagedrops, Devicestops operating.		3.8		V
VPORH	Reset voltage	TA=25°C, VCC rises.		4.1		V
VPORL		TA=25°C, VCC drops.		3.8		V
tPORR	Power-on reset release time	TA=25°C, VCC rises.		10		us
ISCLP	Maximum current source			80		mA
ISCLN	Maximum sink current			40		mA
VOL	Analog output saturation low level	RL>=4.7K		0.5		V
VOH	Analog output saturation high level	RL>=4.7K	VCC-0.3		4.97	V



Symbol	Parameter	Test conditions	Min	Typ	Max	Unit
CL	Output load capacitance	VOUT to GND		0.5	1	nF
RL	Output load resistance	VOUT to GND		10		K
		VOUT to VCC		10		K
ROUT	Output resistance			9		
tR	Rise time	TA=25°C, constant magnetic field 400Gs, CL=1nF, sensitivity 2mV/Gs		5.5		us
TPD	Transmission delay	TA=25°C, constant magnetic field 400Gs, CL=1nF, sensitivity 2mV/Gs		4.5		us
TRESP	Response time	TA=25°C, constant magnetic field 400Gs, CL=1nF, sensitivity 2mV/Gs		4	5	us
VN	Noise	TA=25°C, CL=1nF, sensitivity 2mV/Gs, BWf=Bwi.		14.1		mVp-p
RP	Main Current End Resistance			1.5	1.8	m
Elin	Linear Error	TA=25°C, CL=1nF, sensitivity 2mV/Gs, BWf=Bwi		0.4		%
Voq	Quiescent Point	TA=25°C, CL=1nF, sensitivity 2mV/Gs, BWf=Bwi	2.485	2.500	2.515	V



## Accuracy parameter

### HACS712ELCTR-05B-T

Parameter	Symbol	Conditions	Min	Typ	Max	Unit
Current range	IP			±5		A
Zero Current Output Temperature Coefficient	VOUT(Q)			0.26		mV/°C
Total Output Error	ETOT		-3.0		3.0	%
Output Noise	VNOISE(PP)			46		mV
Sensitivity	Sens	Full Current Range	180	185	190	mV/A
Sensitivity Temperature Coefficient	Sens	TA=150°C, TA=-40°C relative to 25°C		0		%/°C

### HACS712ELCTR-20A-T

Parameter	Symbol	Conditions	Min	Typ	Max	Unit
Current range	IP			±20		A
Zero Current Output Temperature Coefficient	VOUT(Q)			0.26		mV/°C
Total Output Error	ETOT		-3.0		3.0	%
Output Noise	VNOISE(PP)			30		mV
Sensitivity	Sens	Full Current Range	96	100	104	mV/A
Sensitivity Temperature Coefficient	Sens	TA=150°C, TA=-40°C relative to 25°C		0		%/°C

### HACS712ELCTR-30A-T

Parameter	Symbol	Conditions	Min	Typ	Max	Unit
Current range	IP			±30		A
Zero Current Output Temperature Coefficient	VOUT(Q)			0.26		mV/°C
Total Output Error	ETOT		-3.0		3.0	%
Output Noise	VNOISE(PP)			30		mV
Sensitivity	Sens	Full Current Range	64	66.6	69	mV/A
Sensitivity Temperature Coefficient	Sens	TA=150°C, TA=-40°C relative to 25°C		0		%/°C



## Feature definition

### 1. Power-on Time - TPO

Power-on time: The time taken for the power supply to reach the minimum operating voltage  $V_{CC(min)}$  is  $t_1$ ; the time taken for the output to reach 90% of its steady value under an external magnetic field is  $t_2$ . The difference between these two times is the power-on time.

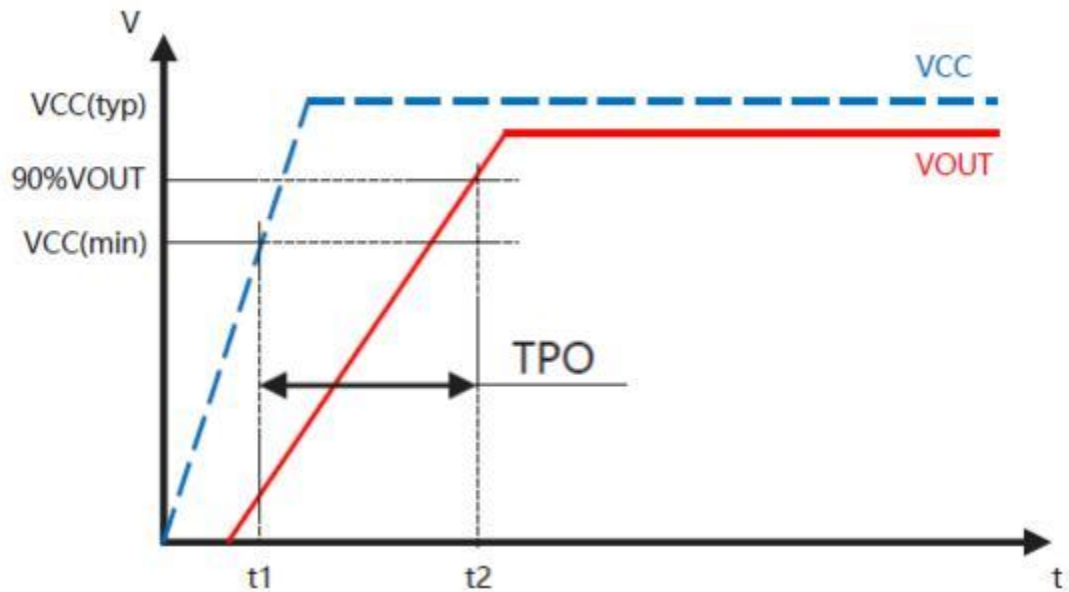

Figure 1: Definition of Power-on Time

### 2. Temperature Compensated Power-on Time - TTC

After power-on, temperature trimming time is required before valid temperature compensation output.



### 3. Transmission Delay-TPD

The time difference between the output reaching 20% of its final value when the external magnetic field reaches 20% of its final value.

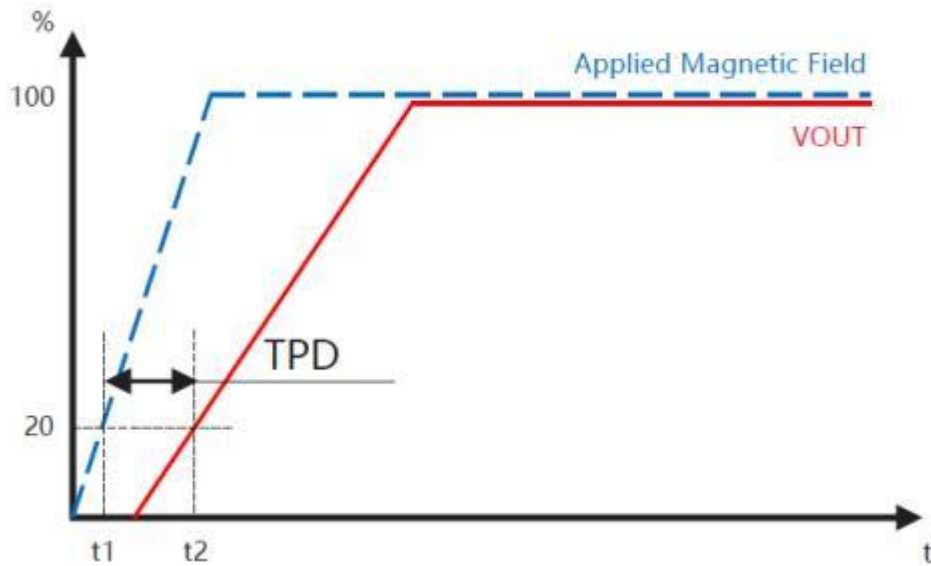

Figure 2: Definition of Transmission Delay

### 4. Rise time - TR

The time difference between the rise of the chip output level from 10% to 90%.

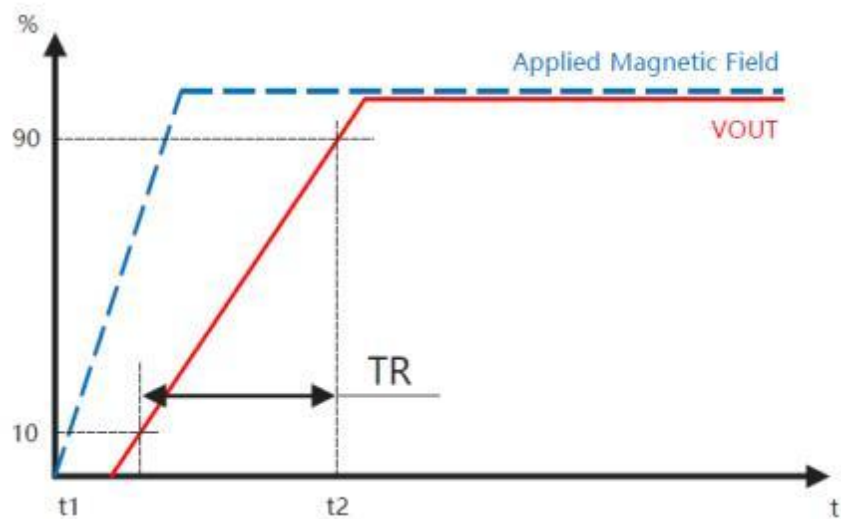

Figure 3: Definition of Rise Time





## 5. Response Time - TRESP

The time difference between when the external magnetic field applied to the chip reaches 80% of its final value and when the corresponding output value also reaches 80%.

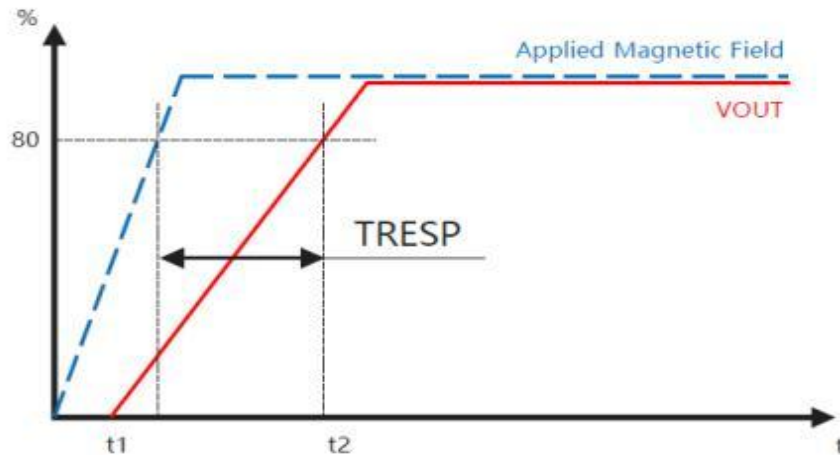

Figure 4: Definition of Response Time

## 6. Static Voltage Output-VOQ

Under the condition that the power supply voltage of the chip and the ambient temperature are within the operating range, and the measured current is 0, the output of the chip is...

Note: Prolonged operation at the maximum rated value may affect the reliability of the device. Exceeding the maximum rated value may damage the device.

## 7. Static Voltage Output Error - VOE

The difference between the actual output voltage of the sensor and the ideal output voltage power supply when the measured current value is zero. In proportional output mode with power supply, the static voltage output error is the difference between the actual output error and  $VCC/2$ .

## 8. Sensitivity

Sensitivity indicates the change value of sensor output per 1A change of measured current, with the unit of mV/A. The calculation method is to pass through the positive full-scale current and negative full-scale current, and divide the difference between the output voltage at 2 points of the sensor by the difference between the positive full-scale current and negative full-scale current, which is the sensitivity of the sensor. The specific calculation formula is as follows.

$$SENS = (V_{out}(I_{Pma0}) - V_{out}(I_{nma0})) / (I_{Pma0} - I_{nma0})$$

Here,  $I_{Pma0}$  and  $I_{nma0}$  are the positive full-scale current and negative full-scale current respectively,  $V_{out}(I_{Pma0})$  and  $V_{out}(I_{nma0})$  are the analog output voltages of the sensor when passing through the positive full-scale current and negative full-scale current respectively



### 9. Global Error Budget -ETOT

This error value represents the maximum error of the sensor under various environmental conditions, which is equal to the absolute value of the measurement error within each temperature range, divided by the maximum output dynamic range of the sensor, over the full current measurement range. It can be expressed as follows.

$$ETOT(IP) = \frac{Ma0(Vout - Vout\_idea)}{(Vout(IPma0) - Voq)}$$

Here,  $Ma0 (Vout - Vout\_idea)$  represents the maximum error within the measurement range and  $(Vout(IPma0) - Voq)$  represents the maximum output dynamic range of the sensor.

### 10. Non-linearity error -ELIN

Due to the non-ideal characteristics of the sensor, the output voltage is not completely linear with the measured current in practical applications. After linear fitting by least squares method, the linearity error of the sensor can be obtained by dividing the maximum output error of the sensor by its dynamic range, i.e.  $ELIN (IP) = \Delta Vout / (Vout (IPma0) - Voq)$ . Here,  $\Delta Vout$  is the maximum linearity error within the measuring range of the sensor.



## Characteristic curve

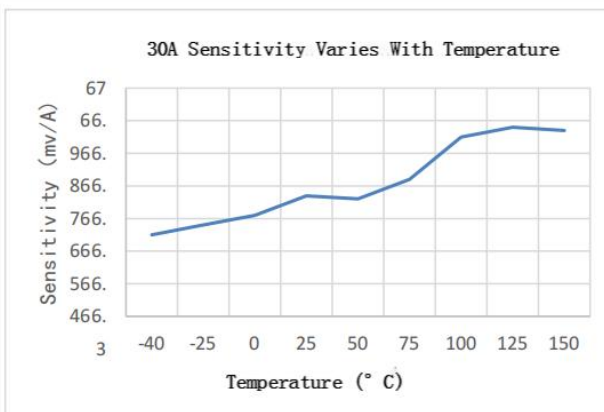
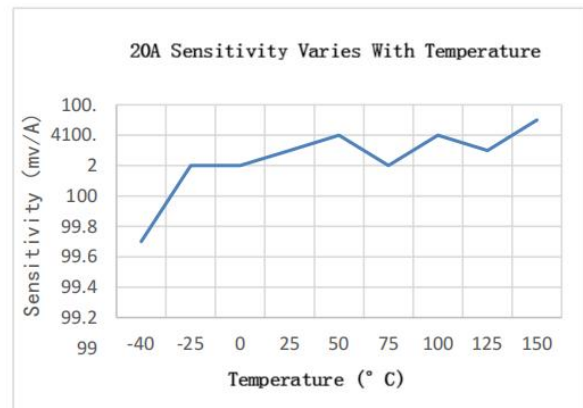
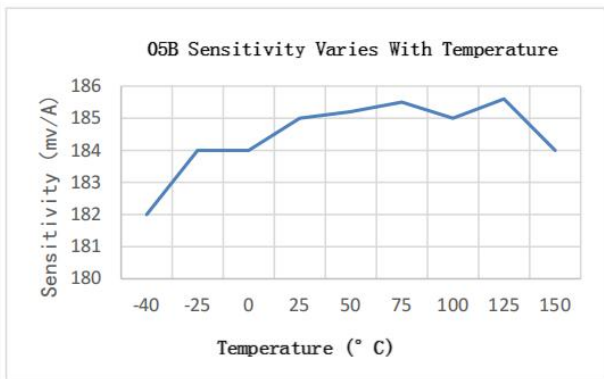
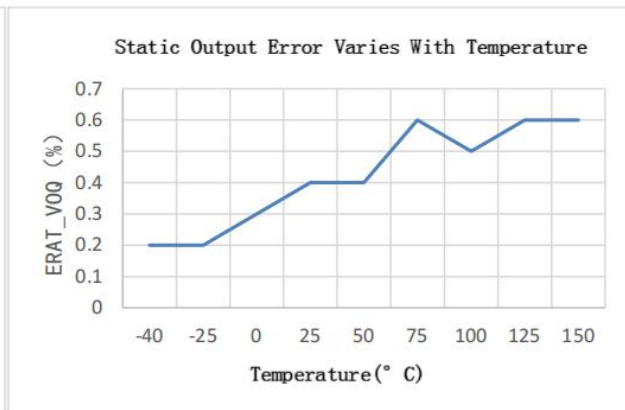
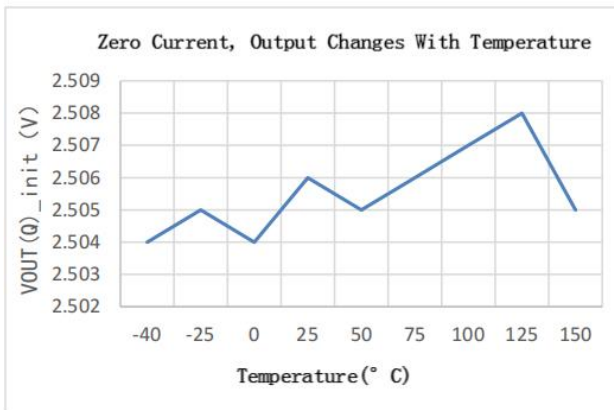
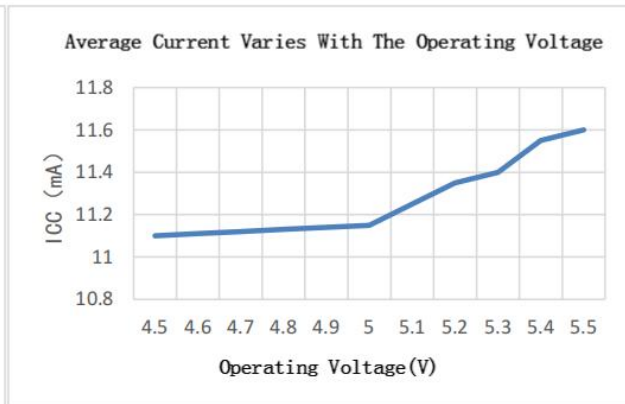
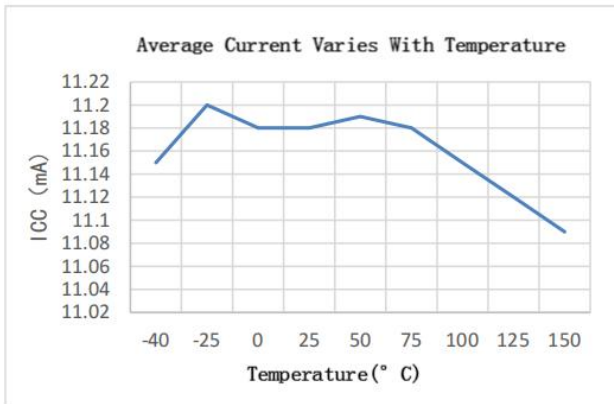



## Typical Application Circuit

The typical application circuit of HACS712ELCTR includes a filter capacitor  $C_{VCC}$  between  $V_{CC}$  and ground, as well as an optional filter capacitor  $C_{Vout}$  between the output and ground. At the input end of the measured current, pins 1 and 2 are shorted together to serve as the input end of the measured current, while pins 3 and 4 are shorted together to serve as the output end of the measured current. The analog output signal of the sensor is perfectly proportional to the AC/DC current being measured.

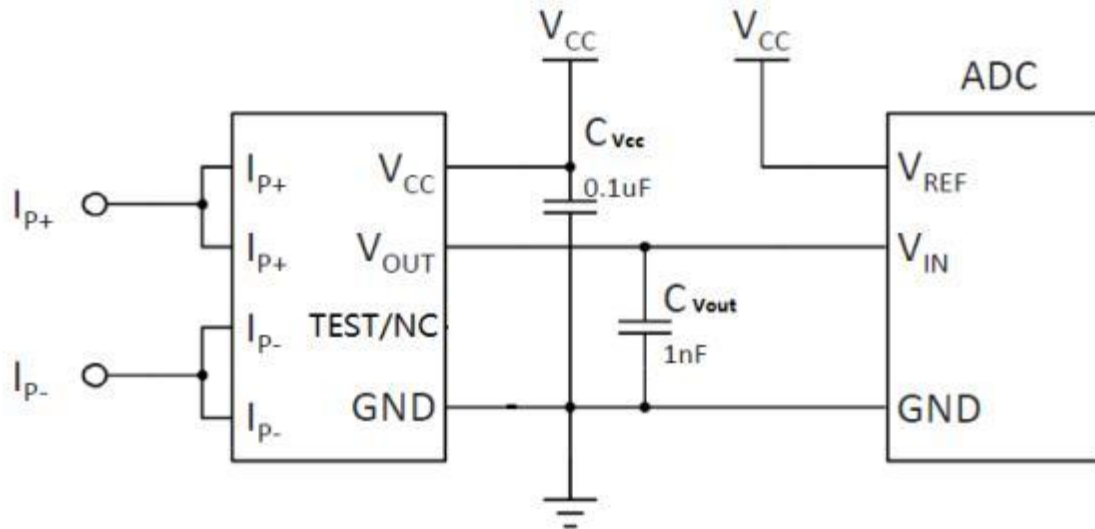

Typical application circuit

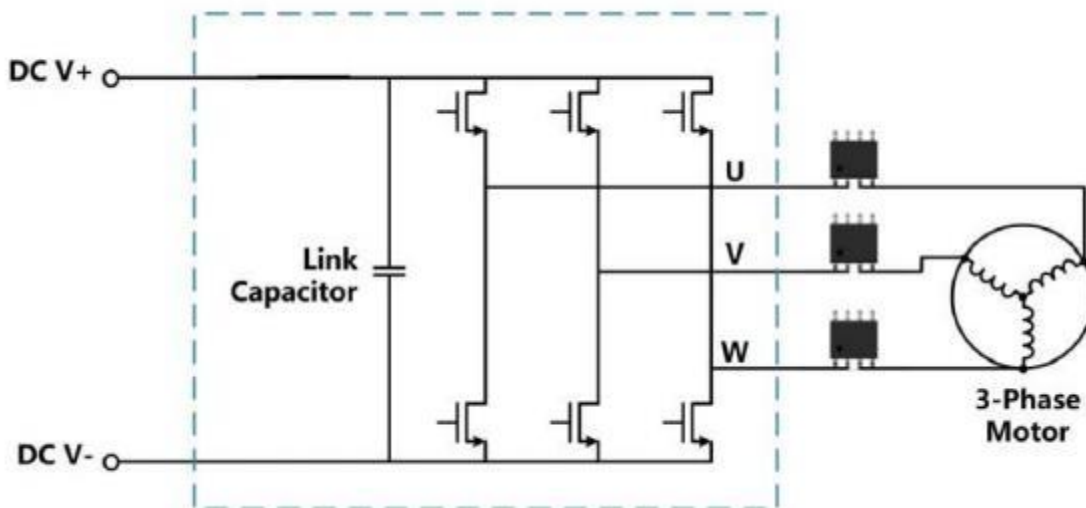

3-Phase Motor Control Application Circuit



## Encapsulate data

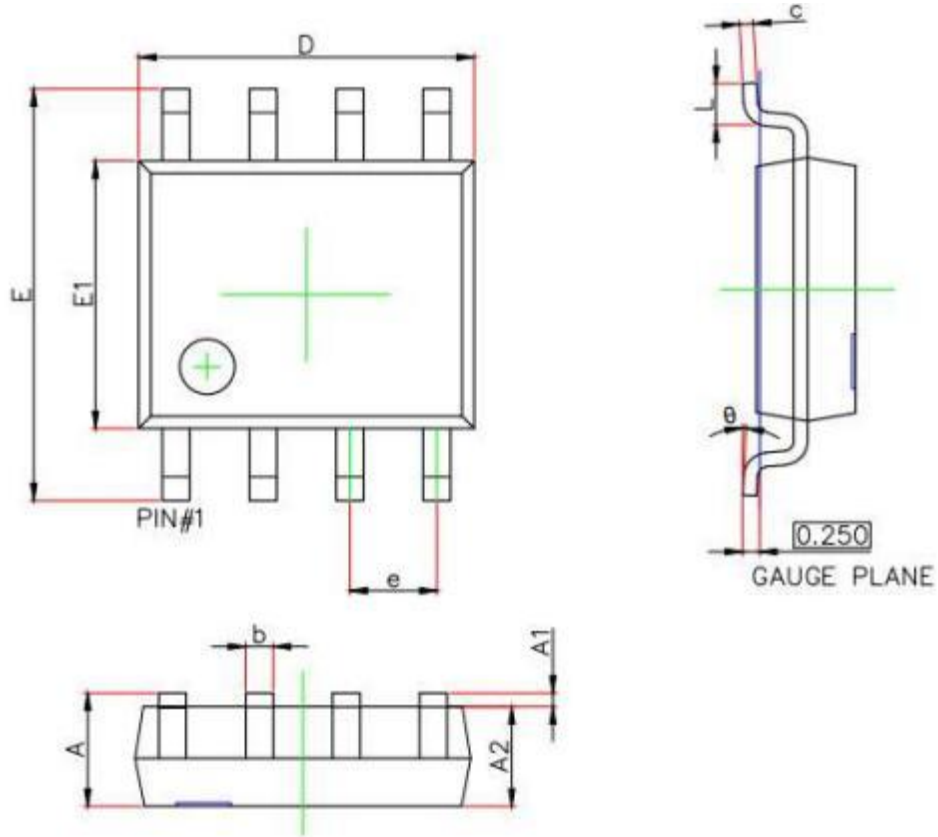

Symbol	Dimensions (mm)		Dimensions (inches)	
	Minimum value	Maximum value	Minimum value	Maximum value
A	1.350	1.750	0.530	0.069
A1	0.100	0.250	0.004	0.010
A2	1.350	1.550	0.053	0.061
b	0.330	0.510	0.013	0.020
c	0.170	0.250	0.007	0.010
D	4.800	5.000	0.189	0.197
e	1.270 (BSC)		0.050 (BSC)	
E	5.800	6.200	0.228	0.224
E1	3.800	4.000	0.150	0.157
L	0.400	1.270	0.016	0.050
$\theta$	0°	8°	0°	8°



### Attention

- Any and all HUA XUAN YANG ELECTRONICS products described or contained herein do not have specifications that can handle applications that require extremely high levels of reliability, such as life-support systems, aircraft's control systems, or other applications whose failure can be reasonably expected to result in serious physical and/or material damage. Consult with your HUA XUAN YANG ELECTRONICS representative nearest you before using any HUA XUAN YANG ELECTRONICS products described or contained herein in such applications.
- HUA XUAN YANG ELECTRONICS assumes no responsibility for equipment failures that result from using products at values that exceed, even momentarily, rated values (such as maximum ratings, operating condition ranges, or other parameters) listed in products specifications of any and all HUA XUAN YANG ELECTRONICS products described or contained herein.
- Specifications of any and all HUA XUAN YANG ELECTRONICS products described or contained herein stipulate the performance, characteristics, and functions of the described products in the independent state, and are not guarantees of the performance, characteristics, and functions of the described products as mounted in the customer's products or equipment. To verify symptoms and states that cannot be evaluated in an independent device, the customer should always evaluate and test devices mounted in the customer's products or equipment.
- HUA XUAN YANG ELECTRONICS CO.,LTD. strives to supply high-quality high-reliability products. However, any and all semiconductor products fail with some probability. It is possible that these probabilistic failures could give rise to accidents or events that could endanger human lives, that could give rise to smoke or fire, or that could cause damage to other property. When designing equipment, adopt safety measures so that these kinds of accidents or events cannot occur. Such measures include but are not limited to protective circuits and error prevention circuits for safe design, redundant design, and structural design.
- In the event that any or all HUA XUAN YANG ELECTRONICS products(including technical data, services) described or contained herein are controlled under any of applicable local export control laws and regulations, such products must not be exported without obtaining the export license from the authorities concerned in accordance with the above law.
- No part of this publication may be reproduced or transmitted in any form or by any means, electronic or mechanical, including photocopying and recording, or any information storage or retrieval system, or otherwise, without the prior written permission of HUA XUAN YANG ELECTRONICS CO.,LTD.
- Information (including circuit diagrams and circuit parameters) herein is for example only ; it is not guaranteed for volume production. HUA XUAN YANG ELECTRONICS believes information herein is accurate and reliable, but no guarantees are made or implied regarding its use or any infringements of intellectual property rights or other rights of third parties.
- Any and all information described or contained herein are subject to change without notice due to product/technology improvement, etc. When designing equipment, refer to the "Delivery Specification" for the HUA XUAN YANG ELECTRONICS product that you intend to use.

## X-ON Electronics

Largest Supplier of Electrical and Electronic Components

*Click to view similar products for [Board Mount Current Sensors](#) category:*

*Click to view products by [HXY MOS](#) manufacturer:*

Other Similar products are found below :

[CSDD1FR](#) [CSNP661-007](#) [S23P50100D15](#) [CSNE151-003](#) [ACS722LLCTR-05AB-T](#) [ACS733KLATR-40AB-T](#) [ACS71240LLCBTR-045B5](#)  
[ACS733KLATR-65AB-T](#) [MT9523CT-20BF5](#) [TLI4971A120T5E0001XUMA1](#) [ACS724LLCTR-30AB-T](#) [ACS724LLCTR-20AB-T](#)  
[ACS724LLCTR-10AB-T](#) [CH704100CT](#) [CC6921SO-20A](#) [CC6921BSO-20A](#) [TMCS1101A3BQDRQ1](#) [TMCS1101A2UQDRQ1](#) [CI770-100A](#)  
[CI5930-20A](#) [ACS733KLATR-20AB-T](#) [ACS758ECB-200B-PFF-T](#) [CI5931-30A](#) [MT9523CT-30BF3](#) [MT9522WT-100BF5](#) [ACS758LCB-](#)  
[050B-PFF-T](#) [TMCS1101A4BQDRQ1](#) [ACS758LCB-100B-PFF-T](#) [JSM6900SO-5A](#) [JSM6900SO-10A](#) [HWW-SW100-16K-W](#) [HWW-S100-](#)  
[16K-FJ-W](#) [MT9522WT-65BF5](#) [ACS773LCB-100B-PFF-T](#) [TMCS1108A3UQDR](#) [TMCS1107A1BQDRQ1](#) [TLE4971A025N5E0001XUMA1](#)  
[CH704050CT](#) [CH70110AB5PR](#) [ACS758KCB-150B-PFF-T](#) [HACS712ELCTR-30A-T](#) [HACS712ELCTR-05B-T](#) [CT-05](#) [CT-07-100](#) [CT-07-50](#)  
[L18P020S05](#) [MR-1](#) [T60404-N4646-X400](#) [T60404-N4646-X661](#) [T60404-N4646-X662](#)