



Features

- 3rd generation SiC MOSFET technology
- Optimized package with separate driver source pin
- High blocking voltage with low on-resistance
- High-speed switching with low capacitances
- Fast intrinsic diode with low reverse recovery (Q_{rr})
- Halogen free, RoHS compliant

Benefits

- Reduce switching losses and minimize gate ringing
- Higher system efficiency
- Reduce cooling requirements
- Increase power density
- Increase system switching frequency

Applications

- Renewable energy
- EV battery chargers
- High voltage DC/DC converters
- Switch Mode Power Supplies

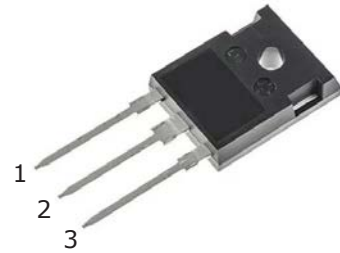

TO-247
Package

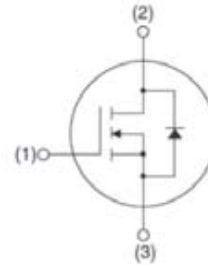

Ordering Part Number	Package	Marking
HC3M0045065D	TO-247	HC3M0045065D



Maximum Ratings ($T_c = 25^\circ\text{C}$ unless otherwise specified)

Parameter	Symbol	Value	Unit
Drain-source voltage	V_{DS}	650	V
Continuous drain current $T_c = 25^\circ\text{C}$ $T_c = 100^\circ\text{C}$	I_D	49 35	A
Pulsed drain current ($T_c = 25^\circ\text{C}$, t_p limited by T_{jmax})	$I_{D\ pulse}$	123	A
Avalanche energy, single pulse ($L=10\text{mH}$)	E_{AS}	1000	mJ
Gate-Source voltage	V_{GS}	-5/+20	V
Gate-Source voltage (dynamic, Absolute maximum values)	V_{GSmax}	-10/+25	V
Power dissipation ($T_c = 25^\circ\text{C}$)	P_{tot}	242	W
Operating junction and storage temperature	T_j, T_{stg}	-55...+175	$^\circ\text{C}$

Thermal Resistance

Parameter	Symbol	Value	Unit
Thermal resistance, junction – case. Max	R_{thJC}	0.62	$^\circ\text{C}/\text{W}$
Thermal resistance, junction – ambient. Max	R_{thJA}	40	



Electrical Characteristic (at $T_j = 25^\circ\text{C}$, unless otherwise specified)

Parameter	Symbol	Value			Unit	Test Condition
		min.	typ.	max.		
Static Characteristic						
Drain-source breakdown voltage	BV_{DSS}	650	-	-	V	$V_{GS}=0V, I_D=250\mu A$
Gate threshold voltage	$V_{GS(th)}$	2	-	4	V	$V_{DS}=V_{GS}, I_D=7mA$
Zero gate voltage drain current	I_{DSS}	-	1	100	μA	$V_{DS}=650V, V_{GS}=0V$ $T_j=25^\circ C$ $T_j=175^\circ C$
Gate-source leakage current	I_{GSS}	-	-	250	nA	$V_{GS}=20V, V_{DS}=0V$
Drain-source on-state resistance	$R_{DS(on)}$	-	45	-	m	$V_{GS}=18V, I_D=17.6A,$
		-	33	49		$V_{GS}=20V, I_D=17.6A,$ $T_j=25^\circ C$
		-	50	-		$T_j=175^\circ C$
Transconductance	g_{fs}	-	5.6	-	S	$V_{DS}=20V, I_D=17.6A$
Dynamic Characteristic						
Input Capacitance	C_{iss}	-	1823	-	pF	$V_{DS} = 650V$ $V_{GS} = 0V$ $T_J = 25^\circ C$ $V_{AC} = 25mV$ $f = 1MHz$
Output Capacitance	C_{oss}	-	190	-		
Reverse Transfer Capacitance	C_{rss}	-	19	-		
Gate Total Charge	Q_G	-	96	-	nC	$V_{DS} = 400V$ $V_{GS} = -5/+20V$ $I_D = 17.6A$
Gate-Source charge	Q_{gs}	-	25	-		
Gate-Drain charge	Q_{gd}	-	26	-		
Turn-On Switching Energy	E_{ON}	-	188	-	μJ	$V_{DD} = 400V$ $V_{GS} = -5/+20V$ $I_D = 17.6A$ $R_G = 10$ $L = 100\mu H$
Turn-Off Switching Energy-	E_{OFF}	-	19	-	ns	
Turn-on delay time	$t_{d(on)}$	-	20	-		
Rise time	t_r	-	26	-		
Turn-off delay time	$t_{d(off)}$	-	48	-		
Fall time	t_f	-	15	-		
Gate resistance	R_G	-	1.7	-	$V_{AC} = 25mV, f=1MHz$	



Body Diode Characteristic

Parameter	Symbol	Value			Unit	Test Condition
		min.	typ.	max.		
Body Diode Forward Voltage	V_{SD}		3.2		V	$V_{GS}=0V, I_{SD}=8.8A,$ $T_J=25^{\circ}C$
			2.6			$V_{GS}=0V, I_{SD}=8.8A,$ $T_J=175^{\circ}C$
Body Diode Reverse Recovery Time	t_{rr}	-	40	-	ns	$V_R = 400V,$ $I_D = 17.6A$ $di/dt = 1000A/\mu S$
Body Diode Reverse Recovery Charge	Q_{rr}	-	156	-	nC	



Typical Performance Characteristics

Fig 1. Output Characteristic ($T_J = -55^\circ\text{C}$)

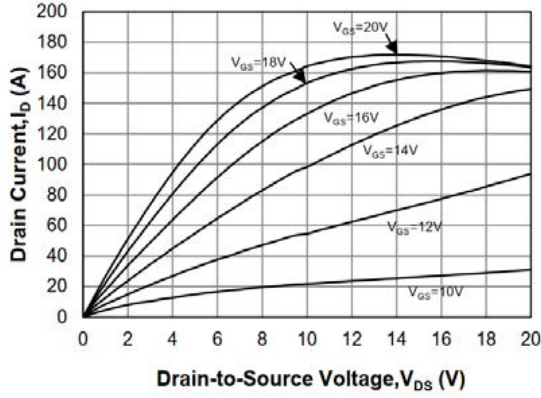

Fig 2. Output Characteristic ($T_J = 25^\circ\text{C}$)

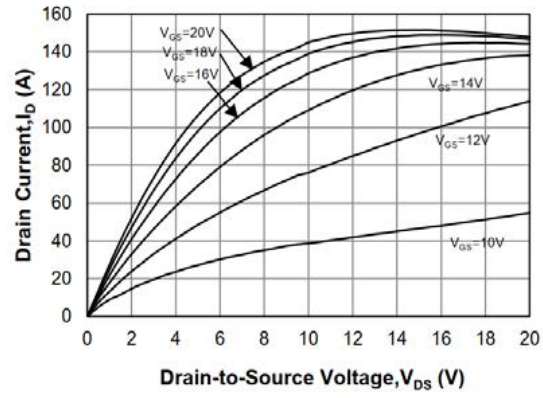

Fig 3. Output Characteristic ($T_J = 175^\circ\text{C}$)

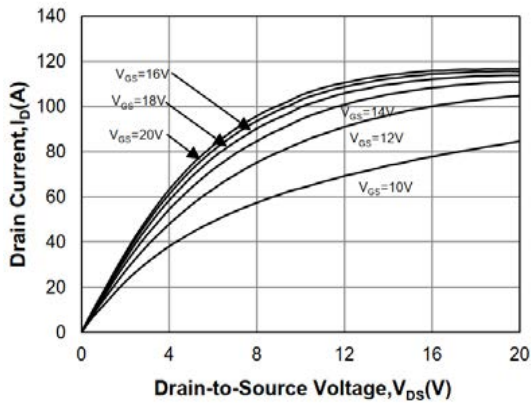

Fig 4: $R_{ds(on)}$ Vs I_{ds} Characteristic

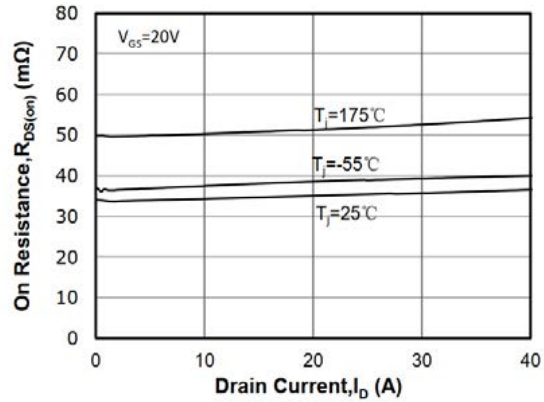

Fig 5: $R_{ds(on)}$ vs. Temperature

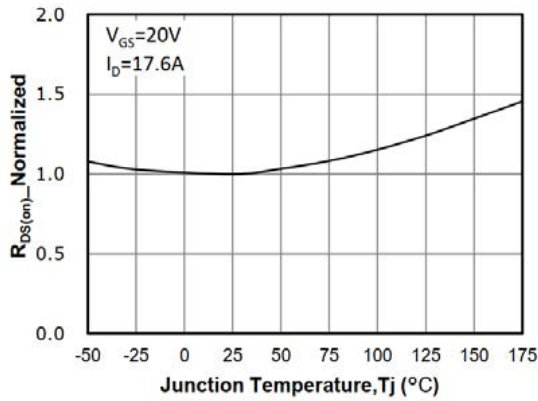

Fig 6: Transfer Characteristic

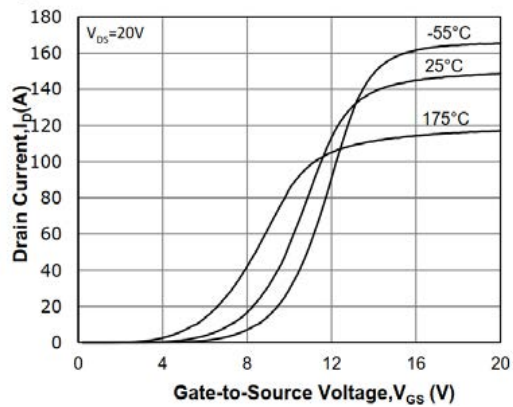



Fig 7: Body-diode Characteristic

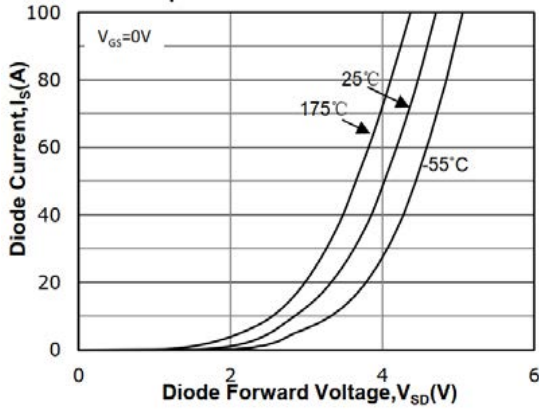

Fig 8: V_{th} Vs T_j Temperature Characteristic

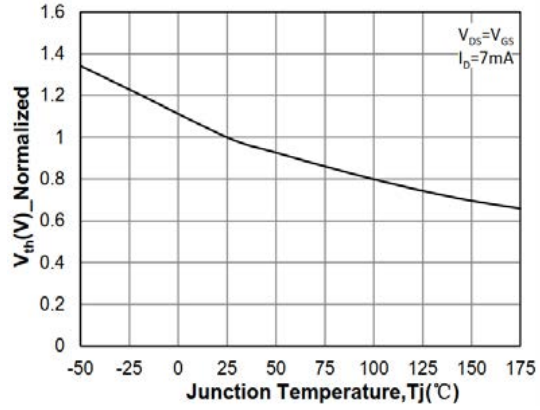

Fig 9: Gate Charge Characteristics

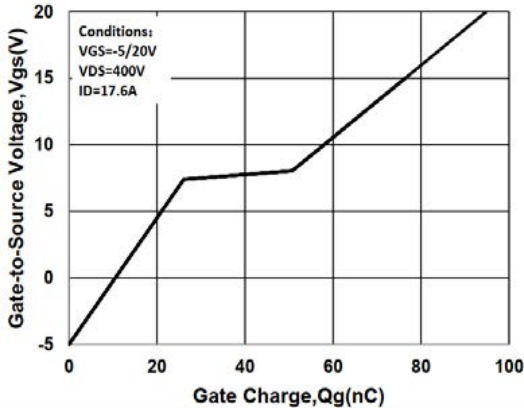

Fig 10: Continuous Drain Current vs. Case Temperature

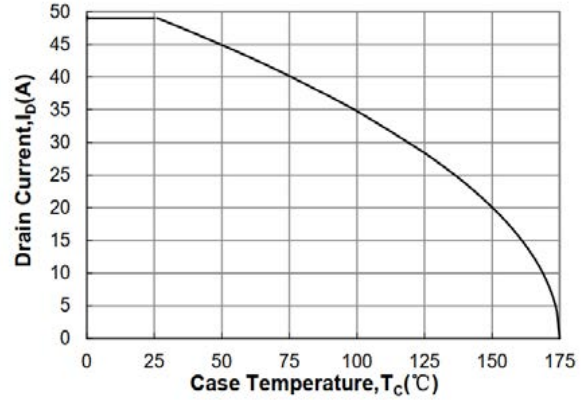

Fig 11: Safe Operating Area

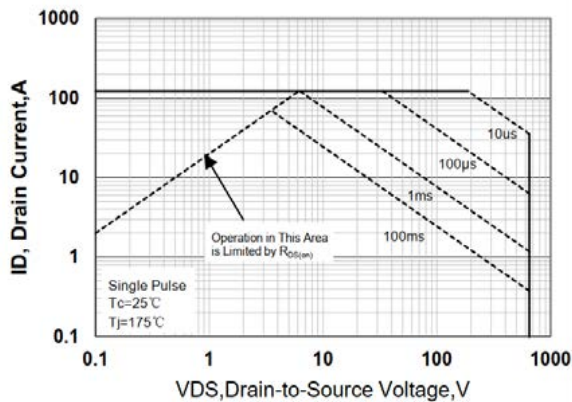

Fig 12: Capacitance Characteristics

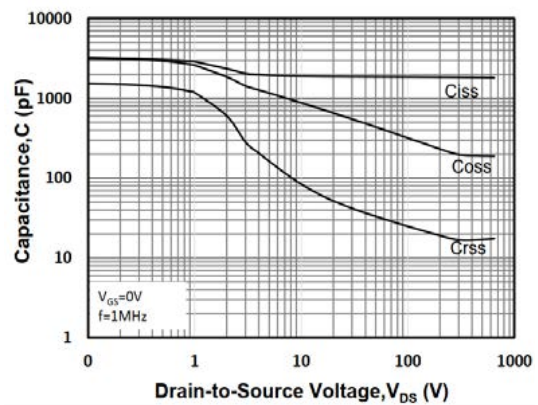
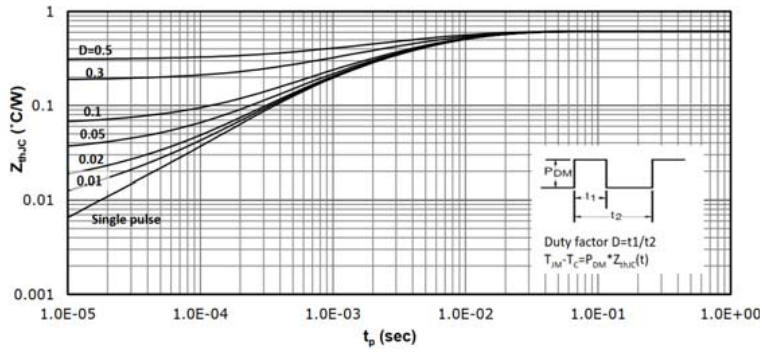



Fig 13: Transient Thermal Impedance



Test Circuit & Waveform

Figure A. Definition of switching times

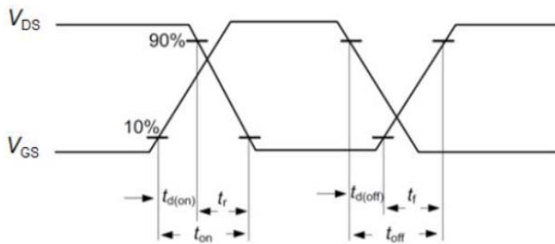

Figure B. Dynamic test circuit

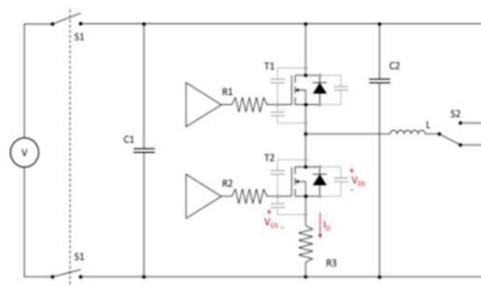
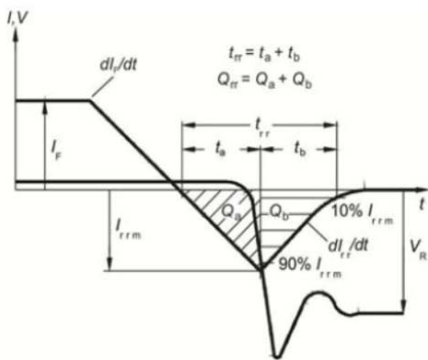

Figure C. Definition of body diodeswitching characteristics





Package Dimensions

Package TO-247

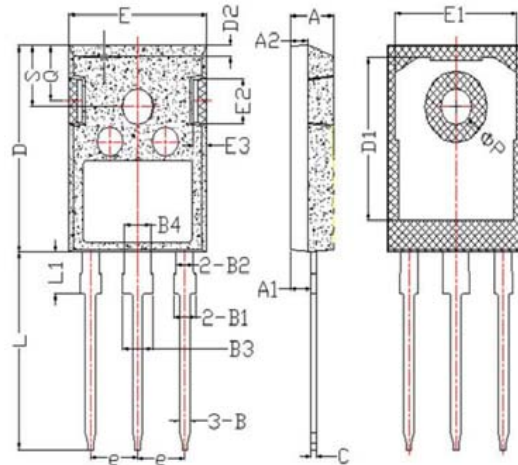

Items	Values(mm)	
	MIN	MAX
A	4.6	5.2
A1	2.2	2.6
B	0.9	1.4
B1	1.75	2.35
B2	1.75	2.15
B3	2.8	3.35
B4	2.8	3.15
C	0.5	0.7
D	20.6	21.3
D1	16	18
E	15.5	16.1
E1	13	14.7
E2	3.8	5.3
E3	0.8	2.6
e	5.2	5.2
L	19	20.5
L1	3.9	4.6
Φp	3.3	3.7
Q	5.2	6
S	5.8	6.6



Attention

- Any and all HUA XUAN YANG ELECTRONICS products described or contained herein do not have specifications that can handle applications that require extremely high levels of reliability, such as life-support systems, aircraft's control systems, or other applications whose failure can be reasonably expected to result in serious physical and/or material damage. Consult with your HUA XUAN YANG ELECTRONICS representative nearest you before using any HUA XUAN YANG ELECTRONICS products described or contained herein in such applications.

- HUA XUAN YANG ELECTRONICS assumes no responsibility for equipment failures that result from using products at values that exceed, even momentarily, rated values (such as maximum ratings, operating condition ranges, or other parameters) listed in products specifications of any and all HUA XUAN YANG ELECTRONICS products described or contained herein.

- Specifications of any and all HUA XUAN YANG ELECTRONICS products described or contained herein stipulate the performance, characteristics, and functions of the described products in the independent state, and are not guarantees of the performance, characteristics, and functions of the described products as mounted in the customer's products or equipment. To verify symptoms and states that cannot be evaluated in an independent device, the customer should always evaluate and test devices mounted in the customer's products or equipment.

- HUA XUAN YANG ELECTRONICS CO.,LTD. strives to supply high-quality high-reliability products. However, any and all semiconductor products fail with some probability. It is possible that these probabilistic failures could give rise to accidents or events that could endanger human lives, that could give rise to smoke or fire, or that could cause damage to other property. When designing equipment, adopt safety measures so that these kinds of accidents or events cannot occur. Such measures include but are not limited to protective circuits and error prevention circuits for safe design, redundant design, and structural design.

- In the event that any or all HUA XUAN YANG ELECTRONICS products(including technical data, services) described or contained herein are controlled under any of applicable local export control laws and regulations, such products must not be exported without obtaining the export license from the authorities concerned in accordance with the above law.

- No part of this publication may be reproduced or transmitted in any form or by any means, electronic or mechanical, including photocopying and recording, or any information storage or retrieval system, or otherwise, without the prior written permission of HUA XUAN YANG ELECTRONICS CO.,LTD.

- Information (including circuit diagrams and circuit parameters) herein is for example only ; it is not guaranteed for volume production. HUA XUAN YANG ELECTRONICS believes information herein is accurate and reliable, but no guarantees are made or implied regarding its use or any infringements of intellectual property rights or other rights of third parties.

- Any and all information described or contained herein are subject to change without notice due to product/technology improvement, etc. When designing equipment, refer to the "Delivery Specification" for the HUA XUAN YANG ELECTRONICS product that you intend to use.

X-ON Electronics

Largest Supplier of Electrical and Electronic Components

Click to view similar products for [MOSFET](#) category:

Click to view products by [HXY MOS](#) manufacturer:

Other Similar products are found below :

[IRFD120](#) [JANTX2N5237](#) [BUK455-60A/B](#) [MIC4420CM-TR](#) [VN1206L](#) [NDP4060](#) [SI4482DY](#) [IPS70R2K0CEAKMA1](#) [SQD23N06-31L-GE3](#)
[TK16J60W,S1VQ\(O](#) [2SK2614\(TE16L1,Q\)](#) [DMN1017UCP3-7](#) [DMN1053UCP4-7](#) [SQJ469EP-T1-GE3](#) [NTE2384](#) [DMC2700UDMQ-7](#)
[DMN2080UCB4-7](#) [DMN61D9UWQ-13](#) [US6M2GTR](#) [DMN31D5UDJ-7](#) [DMP22D4UFO-7B](#) [DMN1006UCA6-7](#) [DMN16M9UCA6-7](#)
[STF5N65M6](#) [IRF40H233XTMA1](#) [STU5N65M6](#) [DMN6022SSD-13](#) [DMN13M9UCA6-7](#) [DMTH10H4M6SPS-13](#) [DMN2990UFB-7B](#)
[IPB80P04P405ATMA2](#) [2N7002W-G](#) [MCAC30N06Y-TP](#) [MCQ7328-TP](#) [NTMC083NP10M5L](#) [NVMFS2D3P04M8LT1G](#) [BXP7N65D](#)
[BXP4N65F](#) [AOL1454G](#) [WMJ80N60C4](#) [BXP2N20L](#) [BXP2N65D](#) [BXT1150N10J](#) [BXT1700P06M](#) [TSM60NB380CP](#) [ROG](#) [RQ7L055BGTCR](#)
[DMNH15H110SK3-13](#) [SLF10N65ABV2](#) [BSO203SP](#) [BSO211P](#)