



概述

HTLP521是可控制的光电耦合器件，电路之间的信号传输，使之前端与负载完全隔离，目的在于增加安全性，减小电路干扰，减化电路设计。四引脚封装，三种形式（DIP、DIP-M、SMD）

特性

- 电流转换比 (CTR)范围: 50~600% ($I_F=5\text{mA}, V_{CE}=5\text{V}$)
- 输入-输出隔离电压 ($V_{iso}=5000\text{Vrms}$)
- 集电极-发射极击穿电压 $BV_{CEO}\geq 80\text{V}$

应用

- 开关电源，智能电表
- 工业控制，测量仪器
- 办公设备，比如复印机
- 家用电器，比如空调、风扇、热水器等

结构原理图

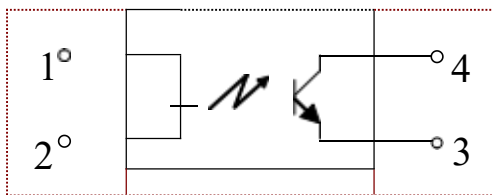

绝对最大额定值 ($T_a=25^\circ\text{C}$)

参数		符号	额定值	单位
输入	正向电流	I_F	50	mA
	反向电压	V_R	6	V
	功耗	P	70	mW
输出	集电极功耗	P_C	150	mW
	集电极电流	I_C	50	mA
	集电极-发射极电压	V_{CEO}	80	V
	发射极-集电极电压	V_{ECO}	7	V
总功耗		P_{tot}	200	mW
隔离电压		V_{iso}	5000	V_{rms}
工作温度		T_{opr}	$0\sim+70$	$^\circ\text{C}$
储存温度		T_{stg}	$-55\sim+125$	$^\circ\text{C}$
焊接温度		T_{sol}	260	$^\circ\text{C}$



光电特性 (Ta=25°C)

参数		符号	条件	最小	额定	最大	单位
输入	正向电压	V_{F1}	$I_F=10mA$	1.0	-	1.3	V
	正向电压	V_{F2}	$I_F=20mA$	1.1	-	1.4	V
	反向电流	I_R	$V_R=5V$	-	-	10	μA
	终端电容	C_t	$V=0, f=1kHz$	-	30	250	pF
输出	集电极暗电流	I_{CEO}	$V_{CE}=50V$	-	-	100	nA
	集电极-发射极击穿电压	BV_{CEO}	$I_C=0.1mA, I_F=0$	80	-	-	V
	发射极-集电极击穿电压	BV_{ECO}	$I_E=10\mu A, I_F=0$	7	-	-	V
传输特性	电流转换比	CTR	$I_F=5mA, V_{CE}=5V$	130	-	600	%
	隔离电阻	$V_{CE(sat)}$	$I_F=2mA, I_C=5mA$	-	0.25	0.8	V
	集电极-发射极饱和压降	R_{ISO}	DC500V, 40~60%R.H.	1×10^{12}	-	-	Ω
	隔离电容	C_f	$V=0, f=1MHz$	-	0.6	1.0	pF
	截止频率	F_c	$V_{CE}=5V, I_C=2mA,$ $R_L=100\Omega, -3dB$	-	80	-	kHz
开关时间	上升时间	T_r	$V_{CE}=10V, I_C=2mA,$ $R_L=100\Omega$	-	2	-	μs
	下降时间	T_f		-	3	-	μs
	开启时间	T_{on}		-	3	-	μs
	关断时间	T_{off}		-	3	-	μs
	开启时间	T_{on}	$R_L = 1.9 k\Omega$ $V_{CC} = 5V, I_F = 16mA$	-	2	-	μs
	存储时间	T_s		-	15	-	μs
	关断时间	T_{off}		-	25	-	μs

* $CTR=I_C/I_F \times 100\%$

CTR分级表

型号	分级标准	电流转换率 (%) (I_C/I_F)	
		$I_F = 5mA, V_{CE} = 5V, T_a = 25^\circ C$	
		Min	Max
HTLP521	HTLP521	50	600
	HTLP521Y	50	150
	HTLP521GR	100	300
	HTLP521BL	200	600
	HTLP521GB	100	600



测试电路与典型特性

Fig.1 测试线路图

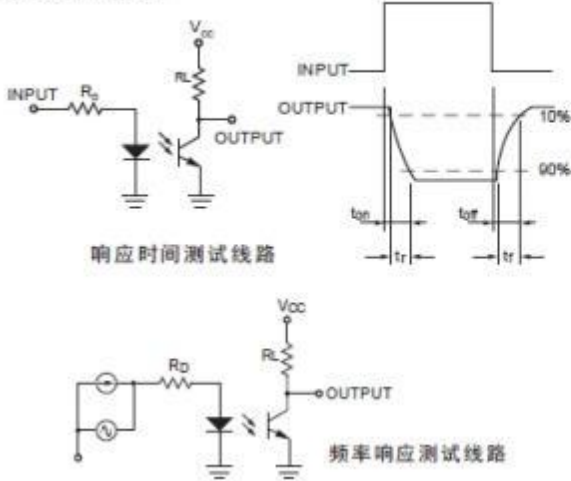

Fig.2 电流转换比 vs 正向电流曲线图

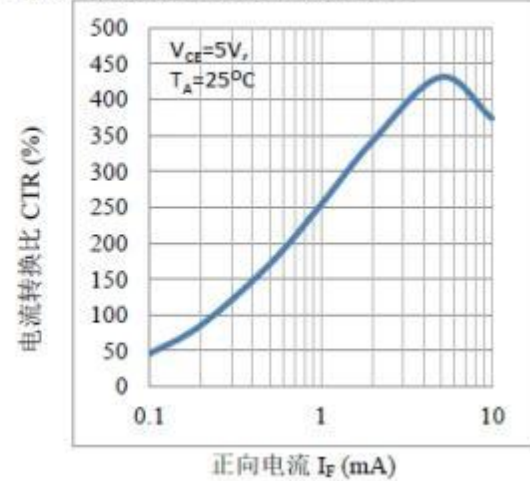

Fig.3 正向电流 vs 正向电压曲线图

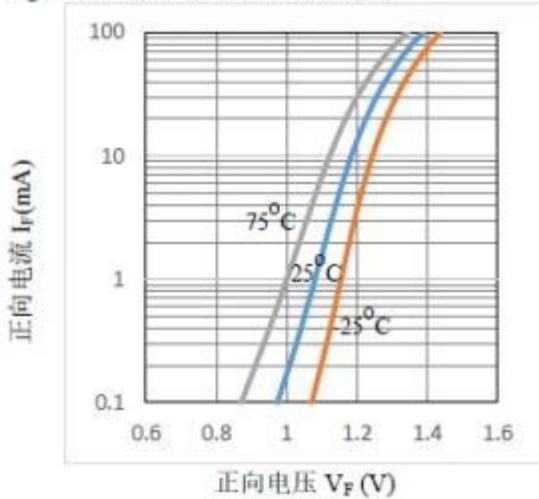

Fig.4 集电极电流 vs 集-发电压曲线图

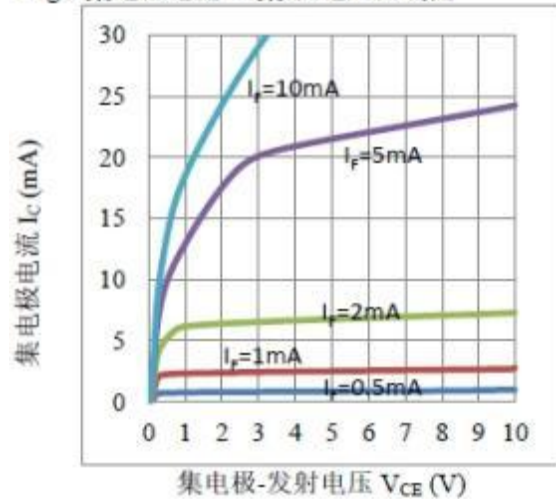

Fig.5 相对电流转换比 vs 环境温度曲线图

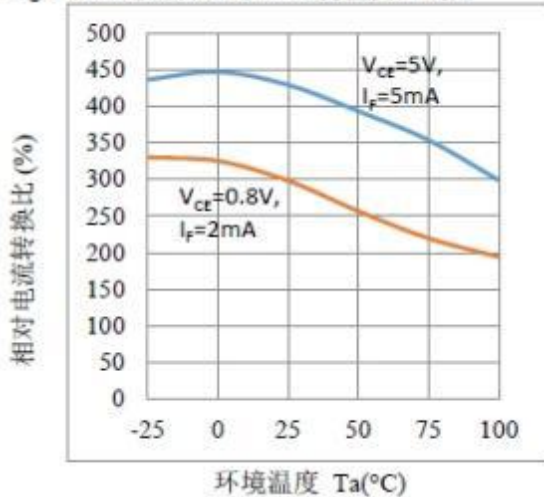

Fig.6 饱和压降 vs 环境温度曲线图

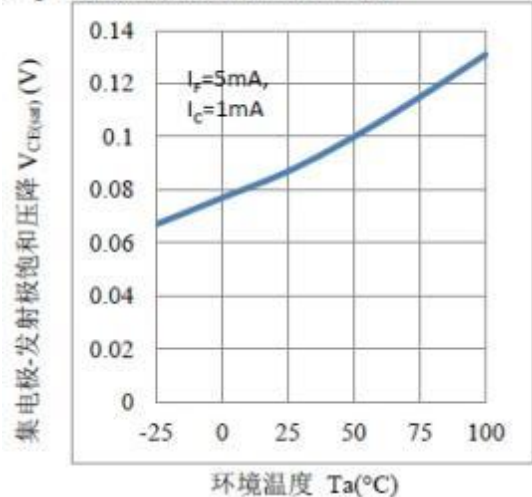



Fig.7 集电极暗电流 vs 环境温度曲线图

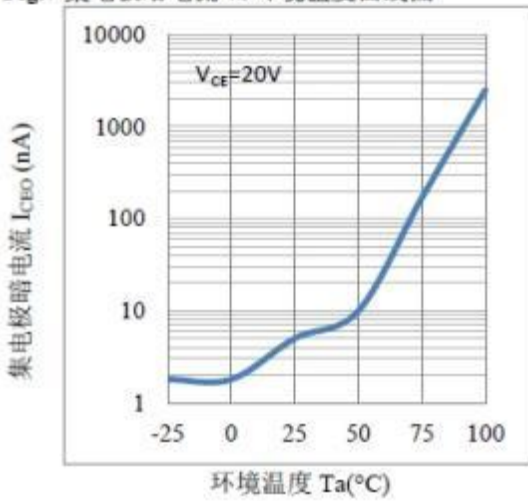

Fig.8 响应时间 vs 负载电阻曲线图

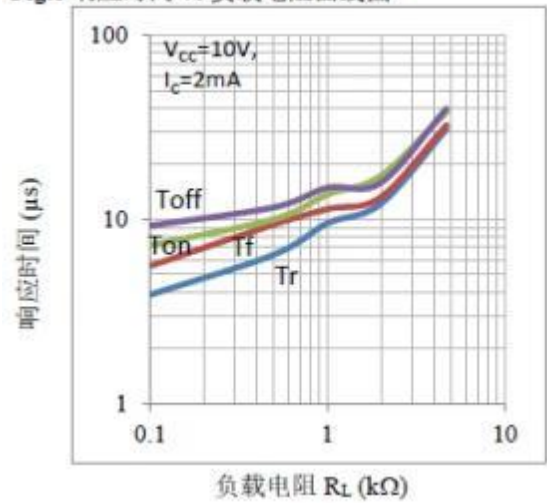

Fig.9 频率响应曲线图

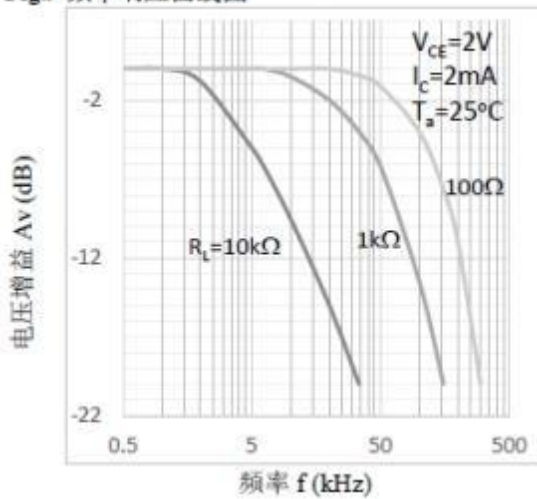
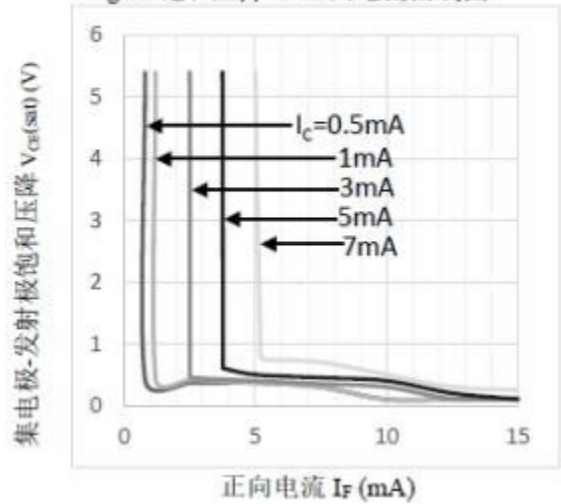

Fig.10 饱和压降 vs 正向电流曲线图





外形尺寸

Unit: mm (inch)

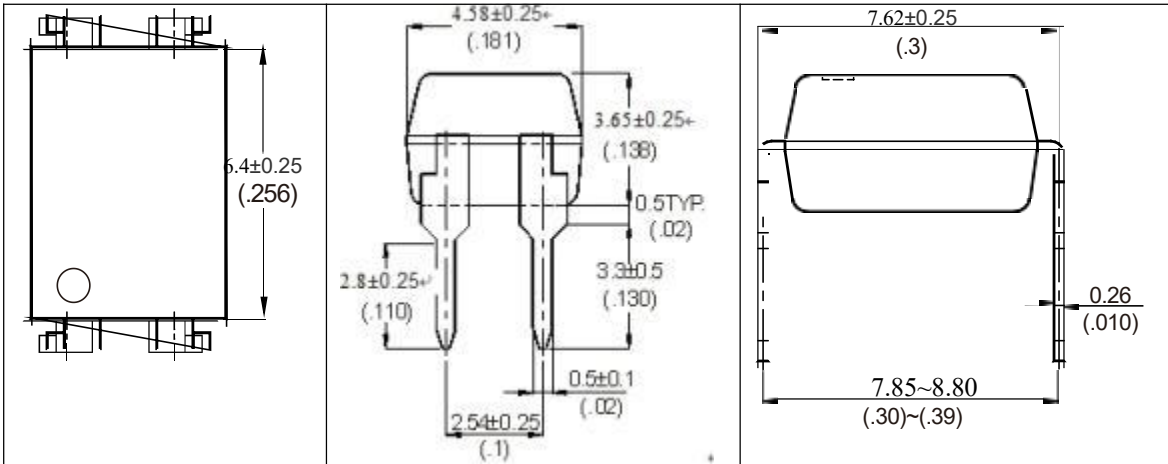

4-pin DIP

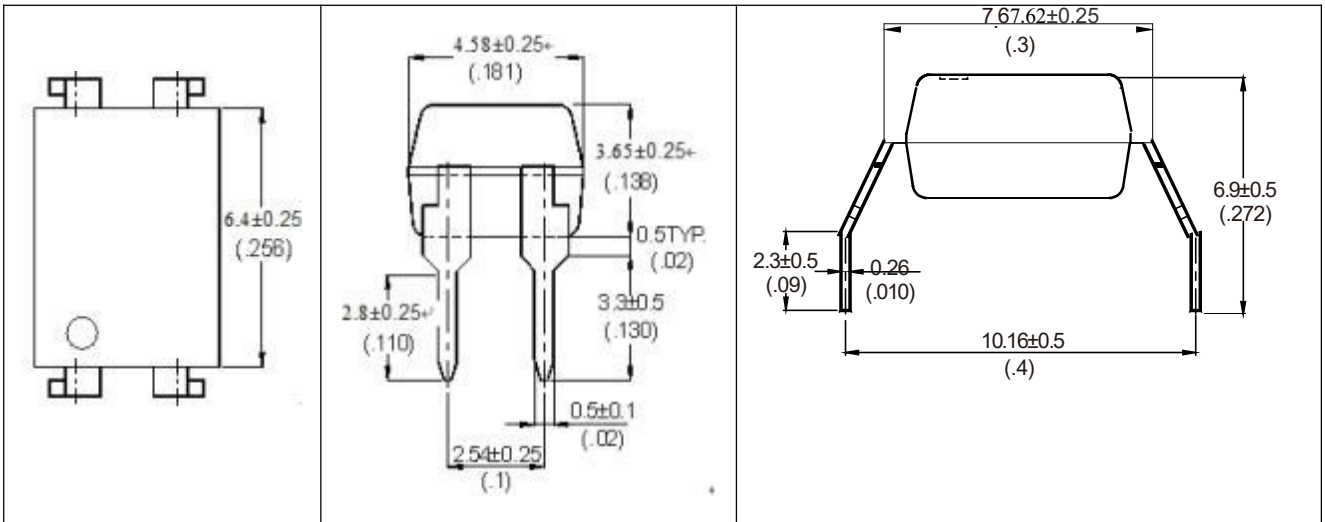

4-pin DIP (M Type)

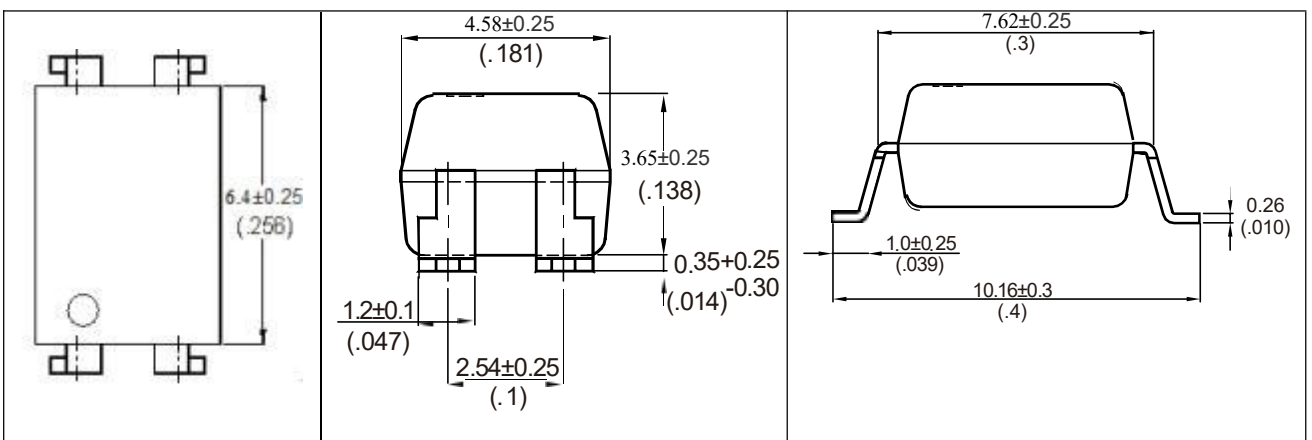

4-pin SMD



回流焊温度曲线图

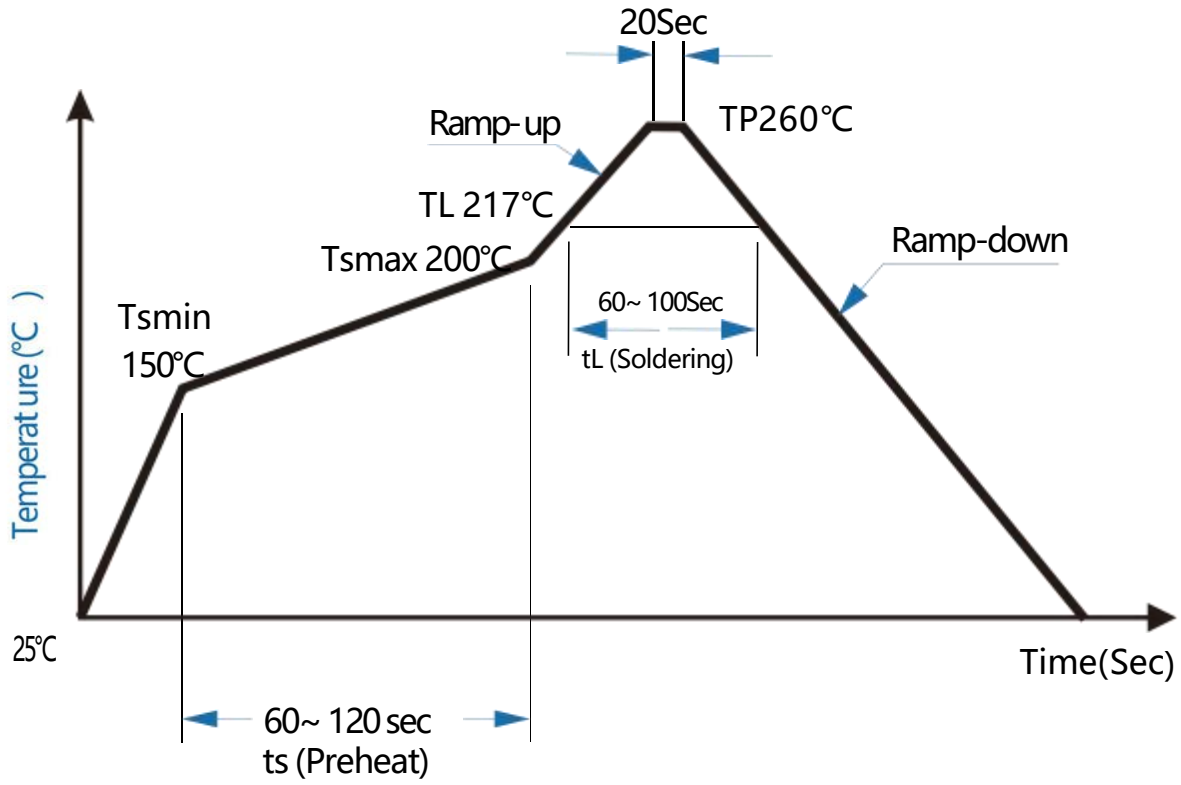



Attention

- Any and all HUA XUAN YANG ELECTRONICS products described or contained herein do not have specifications that can handle applications that require extremely high levels of reliability, such as life-support systems, aircraft's control systems, or other applications whose failure can be reasonably expected to result in serious physical and/or material damage. Consult with your HUA XUAN YANG ELECTRONICS representative nearest you before using any HUA XUAN YANG ELECTRONICS products described or contained herein in such applications.
- HUA XUAN YANG ELECTRONICS assumes no responsibility for equipment failures that result from using products at values that exceed, even momentarily, rated values (such as maximum ratings, operating condition ranges, or other parameters) listed in products specifications of any and all HUA XUAN YANG ELECTRONICS products described or contained herein.
- Specifications of any and all HUA XUAN YANG ELECTRONICS products described or contained herein stipulate the performance, characteristics, and functions of the described products in the independent state, and are not guarantees of the performance, characteristics, and functions of the described products as mounted in the customer's products or equipment. To verify symptoms and states that cannot be evaluated in an independent device, the customer should always evaluate and test devices mounted in the customer's products or equipment.
- HUA XUAN YANG ELECTRONICS CO.,LTD. strives to supply high-quality high-reliability products. However, any and all semiconductor products fail with some probability. It is possible that these probabilistic failures could give rise to accidents or events that could endanger human lives, that could give rise to smoke or fire, or that could cause damage to other property. When designing equipment, adopt safety measures so that these kinds of accidents or events cannot occur. Such measures include but are not limited to protective circuits and error prevention circuits for safe design, redundant design, and structural design.
- In the event that any or all HUA XUAN YANG ELECTRONICS products(including technical data, services) described or contained herein are controlled under any of applicable local export control laws and regulations, such products must not be exported without obtaining the export license from the authorities concerned in accordance with the above law.
- No part of this publication may be reproduced or transmitted in any form or by any means, electronic or mechanical, including photocopying and recording, or any information storage or retrieval system, or otherwise, without the prior written permission of HUA XUAN YANG ELECTRONICS CO.,LTD.
- Information (including circuit diagrams and circuit parameters) herein is for example only ; it is not guaranteed for volume production. HUA XUAN YANG ELECTRONICS believes information herein is accurate and reliable, but no guarantees are made or implied regarding its use or any infringements of intellectual property rights or other rights of third parties.
- Any and all information described or contained herein are subject to change without notice due to product/technology improvement, etc. When designing equipment, refer to the "Delivery Specification" for the HUA XUAN YANG ELECTRONICS product that you intend to use.

X-ON Electronics

Largest Supplier of Electrical and Electronic Components

Click to view similar products for [Transistor Output Optocouplers](#) category:

Click to view products by [HXY MOS](#) manufacturer:

Other Similar products are found below :

[LTV-814S-TA](#) [LTV-852S](#) [66095-001](#) [PS2561-1-A](#) [PS2561A-1-W-A](#) [PS2561L1-1-A](#) [PS2561L-1-V-A](#) [PS2706-1-A](#) [PS2815-1-A](#) [MRF658](#)
[ELD207\(TA\)](#) [ILD2-X006](#) [ILQ615-3X016](#) [LDA102S](#) [SFH615A-4XSM TR](#) [PS2561DL-1Y-F3-A](#) [PS2561L1-1-L-A](#) [PS2562-1-V-A](#) [PS2565L-](#)
[1-A](#) [PS2581L2-A](#) [PS2701A-1-F3-P-A](#) [PS2711-1-A](#) [PS2801-1-F3-P-A](#) [PS2833-4-A](#) [PS2841-4A-AX](#) [LTV-702FS](#) [LTV-702V](#) [LTV-702VB](#)
[LTV-816S-TA](#) [LTV-825S](#) [TCET2100](#) [TLP290-4\(E\(T](#) [IL215AT](#) [WPPC-A11066AA](#) [WPPC-A11066AD](#) [WPPC-A11084ASS](#) [WPPC-](#)
[A21068AA](#) [WPPC-D11066AA](#) [WPPC-D21068ED](#) [WPPC-D410616EA](#) [WPPC-D410616ED](#) [X4IAC24A](#) [4N26-X001](#) [EL1010\(TA\)-VG](#)
[SFH600-2X007](#) [TCMT1118](#) [VO206AT](#) [WPPC-D21068EA](#) [WPPC-D11064AD](#) [WPPC-A410616AD](#)