



## General Description

The MAX811 is low-power microprocessor ( $\mu\text{P}$ ) supervisory circuits used to monitor power supplies in  $\mu\text{P}$  and digital systems.

They provide excellent circuit reliability and low cost by eliminating external components and adjustments when used with 5V-powered or 3V-powered circuits.

The MAX811 also provide a debounced manual reset input.

The only difference between the two devices is that the

MAX811 has an active-low RESET output (which is guaranteed to be in the correct state for VCC down to 1V).

Reset thresholds are available for operation with a variety of supply voltages.

## Features

- Precision Monitoring of 3V, 3.3V, and 5V Power-Supply Voltages
- 140ms Min Power-On Reset Pulse Width
- Guaranteed Over Temperature
- Guaranteed RESET Valid to VCC = 1V
- SOT-143 package

## Selection Table

Part No	Detectable Voltage	Package
MAX810L	4.63V	SOT-143
MAX810M	4.38V	
MAX810T	3.08V	
MAX810S	2.93V	
MAX810R	2.63V	

## Pin Assignment



Pin 1

SOT-143

PIN NO	PIN NAME	FUNCTION
1	GND	Ground
2	RESET	Active-Low Reset Output
3	MR	Manual Reset Input
4	VCC	Supply Voltage

## Applications

- Computers
- Controllers
- Intelligent Instruments
- Portable/Battery-Powered Equipment



## Application Circuits

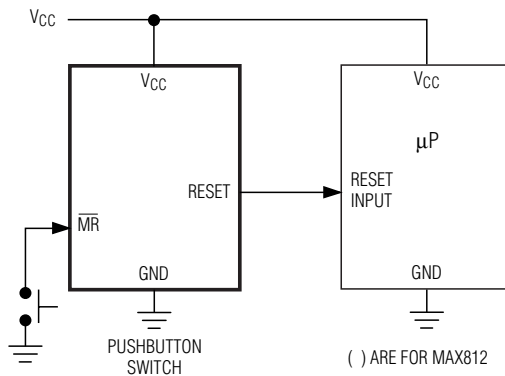

## Absolute Maximum Ratings

Input Voltage .....-0.3V to 6.0V      Storage Temperature .....-40°C to 125°C  
Operating Temperature .....-40°C to 85°C

Note: These are stress ratings only. Stresses exceeding the range specified under "Absolute Maximum Ratings" may cause substantial damage to the device. Functional operation of this device at other conditions beyond those listed in the specification is not implied and prolonged exposure to extreme conditions may affect device reliability.

## Thermal Information

Symbol	Parameter	Max.	Unit
$\theta_{JA}$	Thermal Resistance (Junction to Ambient) (Assume no ambient airflow, no heat sink)	260	°C/W
$P_D$	Power Dissipation	0.32	W

Note:  $P_D$  is measured at  $T_a = 25^\circ\text{C}$



### Electrical Characteristics

Symbol	Parameter	Test Conditions	Min.	Typ.	Max.	Unit
V <sub>CC</sub>	Input Voltage (V <sub>CC</sub> ) Range	TA=25°C	1.2		5.5	V
I <sub>SS</sub>	Supply Current	MAX811L/M:VCC < 5.5V MAX811R/S/T:VCC < 3.6V		6 2.7	15 10	μA
V <sub>DET</sub>	Reset Threshold	MAX811L:TA=25°C	4.54	4.63	4.72	V
		MAX811M:TA=25°C	4.30	4.38	4.46	
		MAX811T:TA=25°C	3.03	3.08	3.14	
		MAX811S:TA=25°C	2.88	2.93	2.98	
		MAX811R:TA=25°C	2.58	2.63	2.68	
	Reset Threshold Stability			30		Ppm/ °C
	V <sub>CC</sub> to Reset Delay	VOD=125mV,MAX811L/M: VOD=125mV,MAX811R/S/T:		40 20		us
t <sub>RP</sub>	Reset Threshold Tempco	VCC=VTH(MAX)	140		560	ms
t <sub>MR</sub>	MR Minimum Pulse Width Tempco		10			us
	MR Glitch Immunity			100		ns
t <sub>MD</sub>	MR to Reset Propagation Delay			0.5		us
V <sub>IH</sub>	MR Input Threshold	VCC > VTH(MAX),MAX811L/M	2.3			V
V <sub>IL</sub>					0.8	
V <sub>IH</sub>		VCC > VTH(MAX),MAX811R/S/T	0.7xVCC			
V <sub>IL</sub>					0.25xVCC	
t <sub>MD</sub>	MR Pull-Up Resistance		10	20	30	kΩ
V <sub>OL</sub>	RESET Output Voltage Low	MAX811L/M:VCC=VTH min,ISINK=1.2mA MAX811R/S/T:VCC=VTH min,ISINK=3.2mA ISINK=50uA,VCC > 1.0V			0.4 0.3	V
V <sub>OH</sub>	RESET Output Voltage High	MAX811L/M only,ISOURCE=150uA MAX811R/S/T only,ISOURCE=150uA VCC > VTH(MAX)	0.8 VCC VCC-1.5			V



### Typical Characteristics

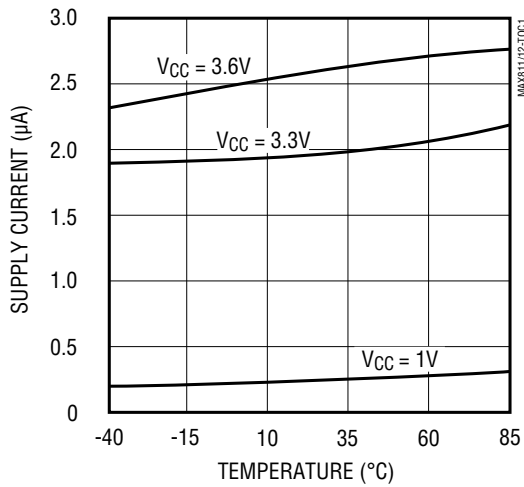

Supply Current vs Temperature  
(No Load, MAX811R/S/T)

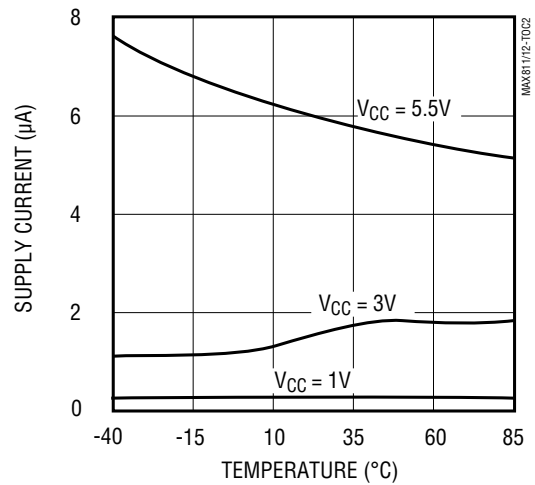

Supply Current vs Temperature  
(No Load, MAX811L/M)

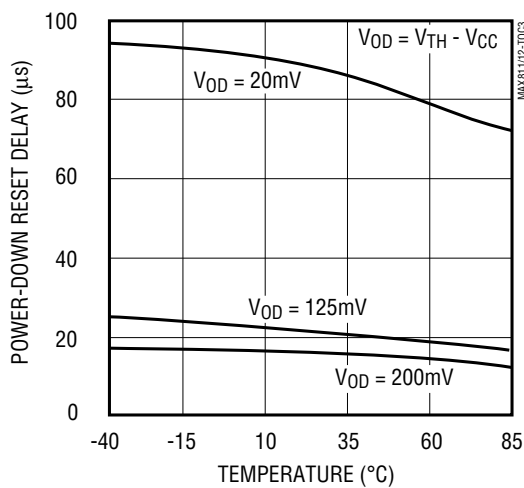

Power-Down Reset Delay vs  
Temperature and (MAX811R/S/T)

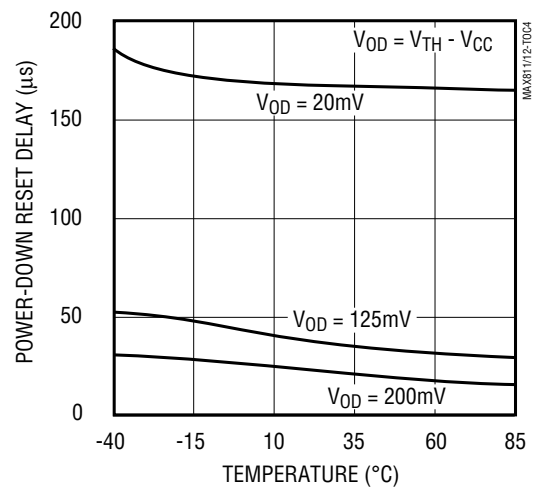

Power-Down Reset Delay vs  
Temperature and (MAX811L/M)

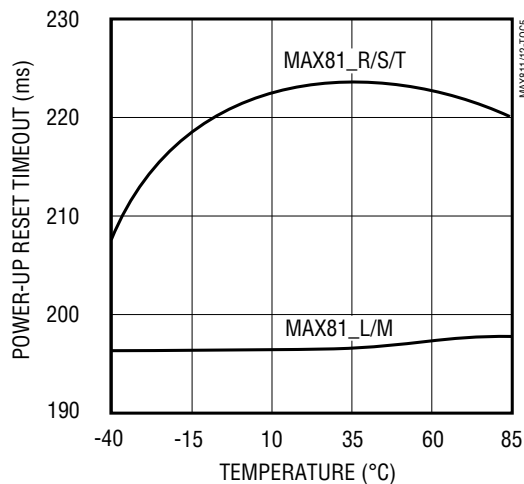

Power-Up Reset Timeout vs  
Temperature

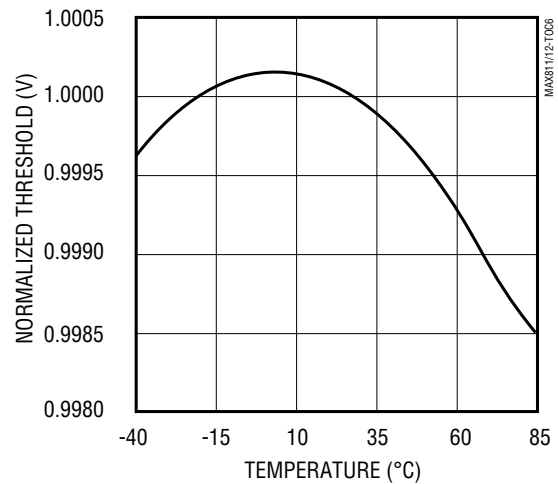

Normalized Reset Threshold vs  
Temperature



### SOT-3 Package Outline Dimensions

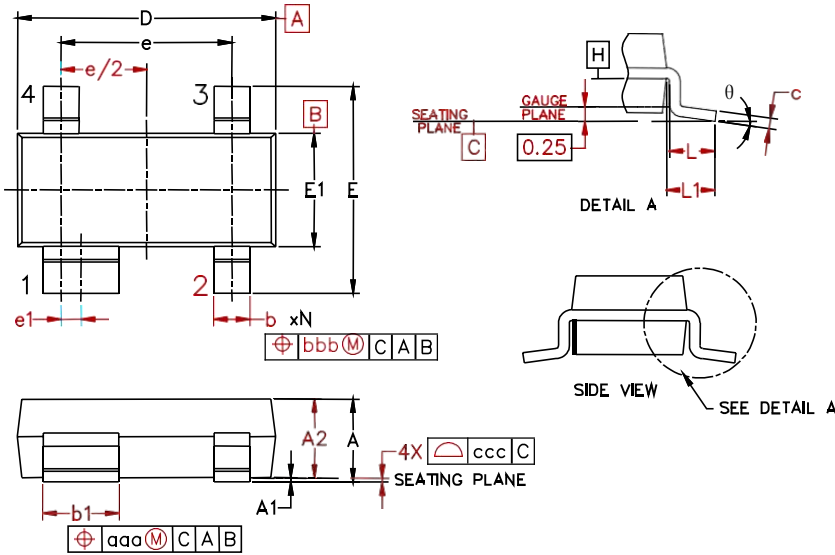

Symbol	Inches			Millimeters		
	Min.	Nom.	Max.	Min.	Nom.	Max.
<b>A</b>	0.031	-	0.048	0.80	-	1.22
<b>A1</b>	0.000	-	0.008	0.013	-	0.15
<b>A2</b>	0.020	0.035	0.042	0.75	0.90	1.07
<b>b</b>	0.011	-	0.020	0.30	-	0.51
<b>b1</b>	0.029	-	0.037	0.76	-	0.94
<b>c</b>	0.003	-	0.008	0.08	-	0.20
<b>D</b>	0.110	0.114	0.120	2.80	2.90	3.04
<b>E</b>	0.082	0.093	0.104	2.10	2.37	2.64
<b>E1</b>	0.047	0.051	0.055	1.20	1.30	1.40
<b>e</b>	0.075		1.92 BSC			
<b>e1</b>	0.008		0.20 BSC			
<b>L</b>	0.015	0.020	0.024	0.40	0.50	0.60
<b>L1</b>	(0.021)		(0.54)			
<b>N</b>	4		4			
<b>θ</b>	0°	-	8°	0°	-	8°
<b>aaa</b>	0.006		0.15			
<b>bbb</b>	0.008		0.20			
<b>ccc</b>	0.004		0.10			



### Attention

- Any and all HUA XUAN YANG ELECTRONICS products described or contained herein do not have specifications that can handle applications that require extremely high levels of reliability, such as life-support systems, aircraft's control systems, or other applications whose failure can be reasonably expected to result in serious physical and/or material damage. Consult with your HUA XUAN YANG ELECTRONICS representative nearest you before using any HUA XUAN YANG ELECTRONICS products described or contained herein in such applications.
- HUA XUAN YANG ELECTRONICS assumes no responsibility for equipment failures that result from using products at values that exceed, even momentarily, rated values (such as maximum ratings, operating condition ranges, or other parameters) listed in products specifications of any and all HUA XUAN YANG ELECTRONICS products described or contained herein.
- Specifications of any and all HUA XUAN YANG ELECTRONICS products described or contained herein stipulate the performance, characteristics, and functions of the described products in the independent state, and are not guarantees of the performance, characteristics, and functions of the described products as mounted in the customer's products or equipment. To verify symptoms and states that cannot be evaluated in an independent device, the customer should always evaluate and test devices mounted in the customer's products or equipment.
- HUA XUAN YANG ELECTRONICS CO.,LTD. strives to supply high-quality high-reliability products. However, any and all semiconductor products fail with some probability. It is possible that these probabilistic failures could give rise to accidents or events that could endanger human lives, that could give rise to smoke or fire, or that could cause damage to other property. When designing equipment, adopt safety measures so that these kinds of accidents or events cannot occur. Such measures include but are not limited to protective circuits and error prevention circuits for safe design, redundant design, and structural design.
- In the event that any or all HUA XUAN YANG ELECTRONICS products(including technical data, services) described or contained herein are controlled under any of applicable local export control laws and regulations, such products must not be exported without obtaining the export license from the authorities concerned in accordance with the above law.
- No part of this publication may be reproduced or transmitted in any form or by any means, electronic or mechanical, including photocopying and recording, or any information storage or retrieval system, or otherwise, without the prior written permission of HUA XUAN YANG ELECTRONICS CO.,LTD.
- Information (including circuit diagrams and circuit parameters) herein is for example only ; it is not guaranteed for volume production. HUA XUAN YANG ELECTRONICS believes information herein is accurate and reliable, but no guarantees are made or implied regarding its use or any infringements of intellectual property rights or other rights of third parties.
- Any and all information described or contained herein are subject to change without notice due to product/technology improvement, etc. When designing equipment, refer to the "Delivery Specification" for the HUA XUAN YANG ELECTRONICS product that you intend to use.

## X-ON Electronics

Largest Supplier of Electrical and Electronic Components

*Click to view similar products for [Supervisory Circuits](#) category:*

*Click to view products by [HXY MOS](#) manufacturer:*

Other Similar products are found below :

[CAT853STBI-T3](#) [RT9818C-27GU3](#) [DS1232L](#) [NCV302HSN45T1G](#) [STM6710FWB7F](#) [PT7M6127NLTA3EX](#) [XC6118C25AGR-G](#)  
[ISL88011IH526Z-TK](#) [ISL88013IH529Z-TK](#) [ISL88705IP846Z](#) [ISL88706IP831Z](#) [ISL88708IB844Z](#) [ISL88708IP831Z](#) [TCM811MERCTR](#)  
[X40420S14-A](#) [X40421S14-C](#) [X40430S14-A](#) [X40430S14I-A](#) [X40430S14I-B](#) [X40431S14-A](#) [X40431S14-B](#) [X40431S14-C](#) [X40431S14I-A](#)  
[X40431S14I-B](#) [X40431S14I-C](#) [X4043P-2.7](#) [X4043PI-2.7](#) [X4043S8-2.7T1](#) [X4043S8IZ-2.7](#) [X4043S8IZT1](#) [X4043S8T1](#) [X4045P](#) [X4045PI](#)  
[X4045PI-2.7](#) [X4045S8-2.7T1](#) [X4045S8IZ](#) [X4045S8T1](#) [X4163P](#) [X4163P-2.7](#) [X4163PI](#) [X4163PI-2.7](#) [X4163S8](#) [X4165P](#) [X4165P-2.7](#)  
[X4165PI](#) [X4165PI-2.7](#) [X4165S8I-2.7](#) [X4283S8I](#) [X4323S8-2.7](#) [X4323S8I-2.7](#)