

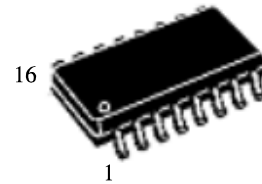

## DESCRIPTION

The SP3232EEN is a 3 V powered EIA/TIA-232 and V.28/V.24 communication interfaces with low power requirements, high data-rate capabilities and enhanced electrostatic discharge (ESD) protection to  $\pm 8$  kV using IEC1000-4-2 contact discharge and  $\pm 15$  kV using the human body model. The ST3232E has a proprietary low-dropout transmitter output stage providing true RS-232 performance from 3 to 5 V supplies with a dual charge pump.

The device is guaranteed to run at data rates of 250 kbps while maintaining RS-232 output levels.



SOP-16

## FEATURES

- ESD protection for RS-232 I/O pins
- $\pm 15$  kV human body model
- $\pm 8$  kV IEC 1000-4-2 contact discharge
- 300  $\mu$ A supply current
- 250 kbps minimum guaranteed data rate
- 6 V/ $\mu$ s minimum guaranteed slew rate
- Meet EIA/TIA-232 specifications down to 3 V
- Available in SOP-16

## APPLICATIONS

- Notebook, subnotebook and palmtop computers
- Battery-powered equipment
- Hand-held equipment
- Peripherals and printers

## ORDERING INFORMATION

Package	Oder No.	Compliance	Supplied As
SOP-16	SP3232EEN	RoHS, Green	Tube



## PIN CONFIGURATION

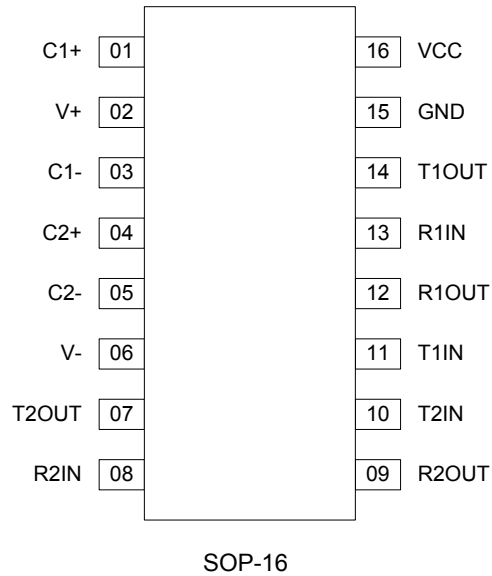

## PIN DESCRIPTION

Pin No.	Pin Name	Pin Description
1	C1+	Positive terminal for the first charge pump capacitor
2	V+	Doubled voltage terminal
3	C1-	Negative Terminal for the first charge pump capacitor
4	C2+	Positive terminal for the second charge pump capacitor
5	C2-	Negative terminal for the second charge pump capacitor
6	V-	Inverted voltage terminal
7	T2OUT	Second transmitter output voltage
8	R2IN	Second receiver input voltage
9	R2OUT	Second receiver output voltage
10	T2IN	Second transmitter input voltage
11	T1IN	First transmitter input voltage
12	R1OUT	First receiver output voltage
13	R1IN	First receiver input voltage
14	T1OUT	First transmitter output voltage
15	GND	Ground
16	VCC	Supply voltage



## SPECIFICATIONS

### Absolute Maximum Ratings

PARAMETER	SYMBOL	MIN.	MAX.	UNIT
Supply Voltage	$V_{CC}$	-0.3	6.0	V
Transmitter High Output Voltage	$V_+$	$V_{CC}-0.3$	7.0	V
Transmitter Low Output Voltage	$V_-$	-0.3	-14	V
Transmitter Input Voltage	$V_{TIN}$	-0.3	$V_++6$	V
Receiver Input Voltage	$V_{RIN}$	-25	25	V
Voltage Applied to Transmitter Output	$V_{TOUT}$	$V_- -13.2$	$V_++12.2$	V
Voltage Applied to Receiver Output	$V_{ROUT}$	-0.3	$V_{CC}+0.3$	V
Storage Temperature Range	$T_{STG}$	-65	150	°C
Thermal resistance junction-to-case <sup>(1) (2)</sup>	$R_{th-jc}$	30		°C/W
Thermal resistance junction-to-ambient <sup>(1) (2)</sup>	$R_{th-ja}$	95		

- Short-circuits can cause excessive heating and destructive dissipation.
- $R_{th}$  are typical values.

### ESD protection

PIN	TEST CONDITIONS	TYP	UNIT
D <sub>OUT</sub> , R <sub>IN</sub>	Human-Body Model	±15	kV
D <sub>OUT</sub> , R <sub>IN</sub>	IEC-1000-4-2	±8	kV

### Electrical Characteristics

SYMBOL	PARAMETER	TEST CONDITIONS	MIN	TYP(1)	MAX	UNIT
I <sub>SUPPLY</sub>	$V_{CC}$ Power supply current	No load, $V_{CC} = 3V$ or $5V$		0.3	1	mA

(1) All typical values are at  $T_A = 25^\circ\text{C}$ .

### Logic input

SYMBOL	PARAMETER	TEST CONDITIONS	MIN	TYP	MAX	UNIT
$V_{TIL}$	Input logic threshold low	T-IN			0.8	V
$V_{HYS}$	Transmitter input hysteresis			0.25		V
$I_{IL}$	Input leakage current T-IN			±0.01	±1	V
$V_{TIH}$	Input logic threshold high	$V_{CC} = 3.3\text{ V}$	2			V
		$V_{CC} = 5\text{ V}$	2.4			



### Transmitter

SYMBOL	PARAMETER	TEST CONDITIONS	MIN	TYP	MAX	UNIT
V <sub>TOUT</sub>	Output voltage swing	All transmitter outputs are loaded with 3 kΩ to GND	±5	±5.4		V
R <sub>TOUT</sub>	Transmitter output resistance	Driver high-level input voltage (D <sub>IN</sub> )	300	10M		Ω
I <sub>SC</sub>	Output short-circuit current			±60		mA
I <sub>TOL</sub>	Output leakage current	V <sub>CC</sub> = 0 V or 3.3 V or 5.5 V, V <sub>CC</sub> = ±12 V Transmitters disable			±25	μA

### Timing characteristics

SYMBOL	PARAMETER	TEST CONDITIONS	MIN	TYP	MAX	UNIT
D <sub>R</sub>	Data transfer rate	R <sub>L</sub> = 3 kΩ, C <sub>L2</sub> = 1000 pF one transmitter switching	250			kbps
t <sub>PHLR</sub> t <sub>PLHR</sub>	Propagation delay input to output	R <sub>XIN</sub> = R <sub>XOUT</sub> , C <sub>L</sub> = 150 pF		0.15		μs
t <sub>OER</sub>	Receiver output enable time	Normal operation		50		ns
t <sub>ODR</sub>	Receiver output disable time	Normal operation		50		ns
t <sub>PHLT</sub> - t <sub>THL</sub>	Transmitter propagation delay difference	(1)		200		ns
t <sub>PHLR</sub> - t <sub>THR</sub>	Receiver propagation delay difference			50		ns
S <sub>RT</sub>	Transition slew rate	T <sub>A</sub> = 25 °C R <sub>L</sub> = 3 kΩ to 7 kΩ V <sub>CC</sub> = 3.3 V measured from +3 V to -3 V or -3 V to +3 V C <sub>L</sub> = 150 pF to 1000 pF C <sub>L</sub> = 150 pF to 2500 pF	6 4		30 30	V/μs V/μs

(1) Transmitter skew is measured at the transmitter zero-cross points.

### Receiver

SYMBOL	PARAMETER	TEST CONDITIONS	MIN	TYP	MAX	UNIT
V <sub>RIN</sub>	Receiver input voltage operating range		-25		25	V
V <sub>RIL</sub>	RS-232 input threshold low	T <sub>A</sub> = 25 °C, V <sub>CC</sub> = 3.3 V	0.6	1.1		V
		T <sub>A</sub> = 25 °C, V <sub>CC</sub> = 5 V	0.8	1.5		
V <sub>RIH</sub>	RS-232 input threshold high	T <sub>A</sub> = 25 °C, V <sub>CC</sub> = 3.3 V		1.4	2.4	V
		T <sub>A</sub> = 25 °C, V <sub>CC</sub> = 5 V		1.8	2.4	
V <sub>RIHYS</sub>	Input hysteresis			0.5		V
R <sub>RIN</sub>	Input resistance	T <sub>A</sub> = 25 °C	3	5	7	kΩ
V <sub>ROL</sub>	TTL/CMOS Output voltage low	I <sub>OUT</sub> = 1.6 mA			0.4	V
V <sub>ROH</sub>	TTL/CMOS Output voltage high	I <sub>OUT</sub> = -1 mA	V <sub>CC</sub> -0.6	V <sub>CC</sub> -0.1		V





## TYPICAL PERFORMANCE CHARACTERISTICS

Output current vs. output high voltage

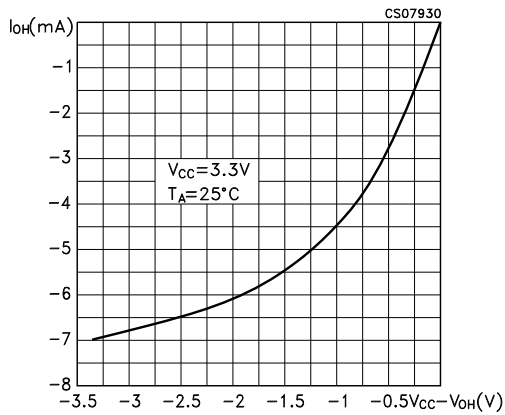

Output current vs. output high voltage

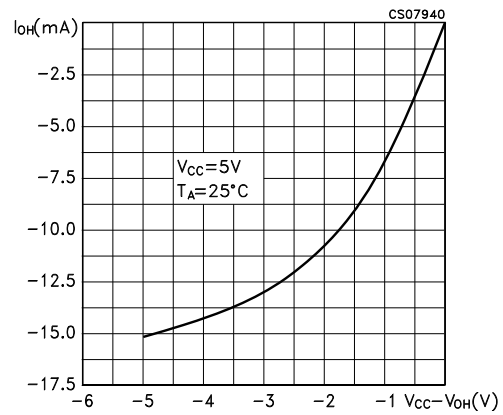

Output current vs. output low voltage

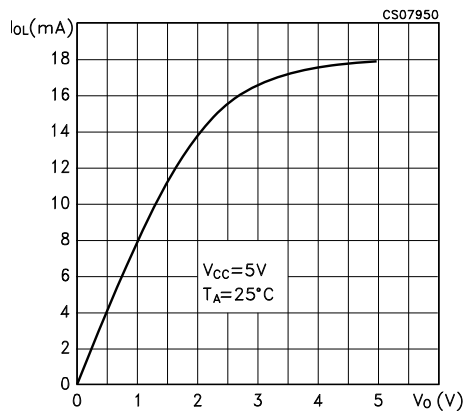

Output current vs. output low voltage

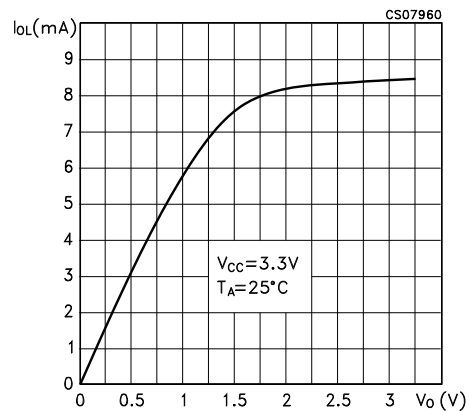

Voltage transfer characteristics for transmitter inputs

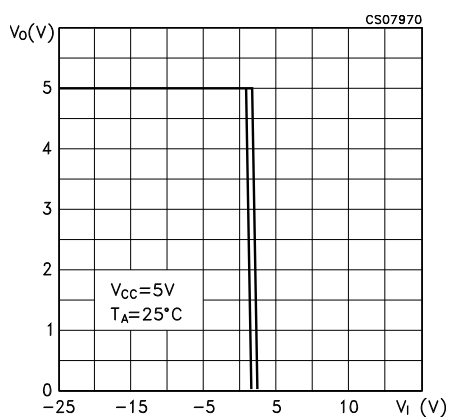

Receiver input resistance

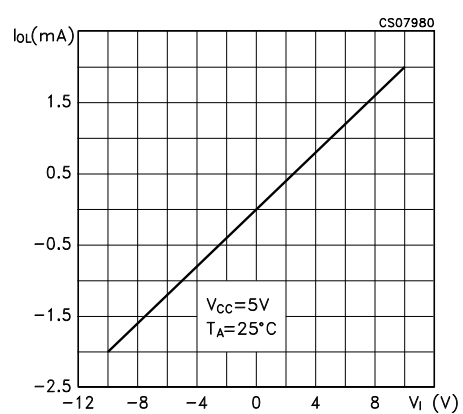



**PACKAGE OUTLINE DIMENSIONS**  
**SOP-16**

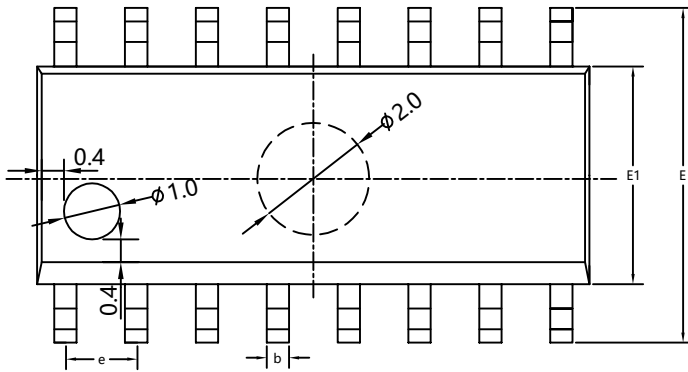
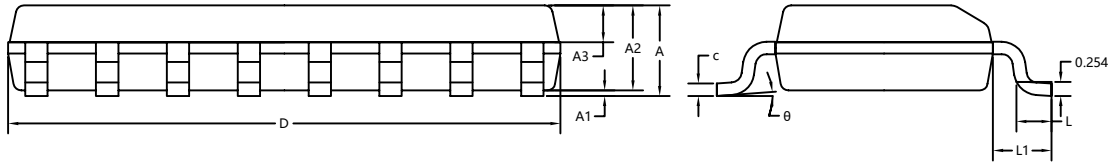

SYMBOL	MILLIMETER		
	MIN	NOM	MAX
A	1.50	1.60	1.70
A1	0.10	0.15	0.25
A2	1.40	1.45	1.50
A3	0.60	0.65	0.70
b	0.30	0.40	0.50
c	0.15	0.20	0.25
D	9.80	9.90	10.00
E	5.80	6.00	6.20
E1	3.85	3.90	3.95
e	1.27BSC		
L	0.50	0.60	0.70
L1	1.05BSC		
theta	0°	4°	8°



### Attention

- Any and all HUA XUAN YANG ELECTRONICS products described or contained herein do not have specifications that can handle applications that require extremely high levels of reliability, such as life-support systems, aircraft's control systems, or other applications whose failure can be reasonably expected to result in serious physical and/or material damage. Consult with your HUA XUAN YANG ELECTRONICS representative nearest you before using any HUA XUAN YANG ELECTRONICS products described or contained herein in such applications.
- HUA XUAN YANG ELECTRONICS assumes no responsibility for equipment failures that result from using products at values that exceed, even momentarily, rated values (such as maximum ratings, operating condition ranges, or other parameters) listed in products specifications of any and all HUA XUAN YANG ELECTRONICS products described or contained herein.
- Specifications of any and all HUA XUAN YANG ELECTRONICS products described or contained herein stipulate the performance, characteristics, and functions of the described products in the independent state, and are not guarantees of the performance, characteristics, and functions of the described products as mounted in the customer's products or equipment. To verify symptoms and states that cannot be evaluated in an independent device, the customer should always evaluate and test devices mounted in the customer's products or equipment.
- HUA XUAN YANG ELECTRONICS CO.,LTD. strives to supply high-quality high-reliability products. However, any and all semiconductor products fail with some probability. It is possible that these probabilistic failures could give rise to accidents or events that could endanger human lives, that could give rise to smoke or fire, or that could cause damage to other property. When designing equipment, adopt safety measures so that these kinds of accidents or events cannot occur. Such measures include but are not limited to protective circuits and error prevention circuits for safe design, redundant design, and structural design.
- In the event that any or all HUA XUAN YANG ELECTRONICS products(including technical data, services) described or contained herein are controlled under any of applicable local export control laws and regulations, such products must not be exported without obtaining the export license from the authorities concerned in accordance with the above law.
- No part of this publication may be reproduced or transmitted in any form or by any means, electronic or mechanical, including photocopying and recording, or any information storage or retrieval system, or otherwise, without the prior written permission of HUA XUAN YANG ELECTRONICS CO.,LTD.
- Information (including circuit diagrams and circuit parameters) herein is for example only ; it is not guaranteed for volume production. HUA XUAN YANG ELECTRONICS believes information herein is accurate and reliable, but no guarantees are made or implied regarding its use or any infringements of intellectual property rights or other rights of third parties.
- Any and all information described or contained herein are subject to change without notice due to product/technology improvement, etc. When designing equipment, refer to the "Delivery Specification" for the HUA XUAN YANG ELECTRONICS product that you intend to use.



## X-ON Electronics

Largest Supplier of Electrical and Electronic Components

*Click to view similar products for [RS-232 Interface IC category](#):*

*Click to view products by [HXY MOS manufacturer](#):*

Other Similar products are found below :

[062191EB](#) [SP508ECF-L](#) [XR32330EBERTR-F](#) [CH438L](#) [HIN202CB](#) [HIN202CBN](#) [HIN202EIB](#) [HIN206CB](#) [HIN206EIA](#) [HIN207EIAZ](#)  
[HIN207EIBZ](#) [HIN208ECB](#) [HIN213EIB](#) [HIN232ACB](#) [HIN232ACBN](#) [HIN232ACP](#) [HIN232CB](#) [HIN232ECP](#) [HIN232IB](#) [HIN232IP](#)  
[HIN238CB](#) [HIN239CB](#) [HIN241CA](#) [ICL232CBE](#) [ICL232IBE](#) [ICL3207ECA](#) [ICL3217ECB](#) [ICL3221CV](#) [ICL3221ECA](#) [ICL3221ECV](#)  
[ICL3221IA](#) [ICL3223CA](#) [ICL3223ECA](#) [ICL3223IA](#) [ICL3225ECA](#) [ICL3232CA](#) [ICL3232CP](#) [ICL3232CV](#) [ICL3232ECB](#) [ICL3232IBN](#)  
[ICL3232IV](#) [ICL3237CA](#) [ICL3237ECA](#) [ICL3238ECA](#) [ICL3241ECA](#) [ICL3243CA](#) [ICL3243CB](#) [ICL3243ECA](#) [ICL3243ECB](#) [ICL3243ECV](#)