



产品规格书

PRODUCT SPECIFICATION

客户名称

CUSTOMER

宏业产品系列

CMF 系列共模扼流圈

PRODUCT SERIES

COMS SERIES COMMON MODE CHOKE

宏业规格型号

PRODUCT TYPE

客户型号规格

CUSTOMER'S PRODUCT TYPE

研发	品质	业务	批准

深圳市宏业兴电子有限公司 SHENZHEN HONGYEX ELECTRONICS CO.,LTD.

传真 Fax number: 0755-83295141

邮箱 Email: hy@hongyex.com

公司地址: 广东省深圳市福田区深南中路佳和大厦 A 座 23 层

Company address: 23/F,Block A,Jiahe building,Shenzhen City,Guangdong Province,China

工厂地址: 惠州市罗阳镇鸿达工业区五号宏业兴工业园

Factory address:Hongyexing Industrial Park, No.5, Hongda Industrial Zone,Luoyang Town,Huizhou City,Guangdong Province,China

备注 REMARK:

客户回签 CUSTOMER APPROVAL

--	--	--



变更履历 Change list

序号 NO.	修改日期 DATE	修改内容 CHANGE CONTENT	版本号 Version NO.
1	2015.12.12	初版 First edition	A1
2	2019.11.29	更新联系方式 Update contact	A2
3	2020.07.01	更新物料 Update material	A3
4	2020.07.25	更新规格 Update specification	A4
5	2020.08.28	增加 CMF7060 系列 Increase CMF7060 series	A5
6	2020.09.03	增加 CMF9070 系列 Increase CMF9070 series	B1

1 用途 APPLICATIONS

可有效的抑制在数字设备上信号线所产生的共模噪声。

The COMS series is effective for common mode noise suppression in digital equipment.

独石结构，磁屏蔽，无漏磁，适用于高密度贴装。

With co-fired ferrite material, low leakage flux and high coupling coefficient is achieved.

2 特点 FEATURES

平板电脑、笔记本电脑、台式电脑及其周边设备的高速信号线路。

High speed interfaces of tablet PC, notebook, desktop computers and peripheral equipment.

蓝光 DVD、数码相机、数码摄像机、液晶电视的差模线路。

Differential interfaces of Blu-ray DVD recorder, DSC, DVC, LCD Television.

移动电话、智能手机的 USB 线路。

USB interfaces of mobile phone, smart phone.

各类差模电路。

Various differential circuits.

3 产品编码 PRODUCT IDENTIFICATION

CMF 2012 F - 900 - 2P - T

① ② ③ ④ ⑤ ⑥

①	Type: COMMON MODE CHOKE
②	External Dimensions (L×W×T) (mm): 2.0*1.2*1.2
③	Shielding type
④	Nominal Impedance: 900, 90Ω
⑤	Number of line: 2P:2-Line
⑥	Taping style

4 等效电路图，外形及尺寸 EQUIVALENT CIRCUIT DIAGRAM, SHAPE AND DIMENSIONS

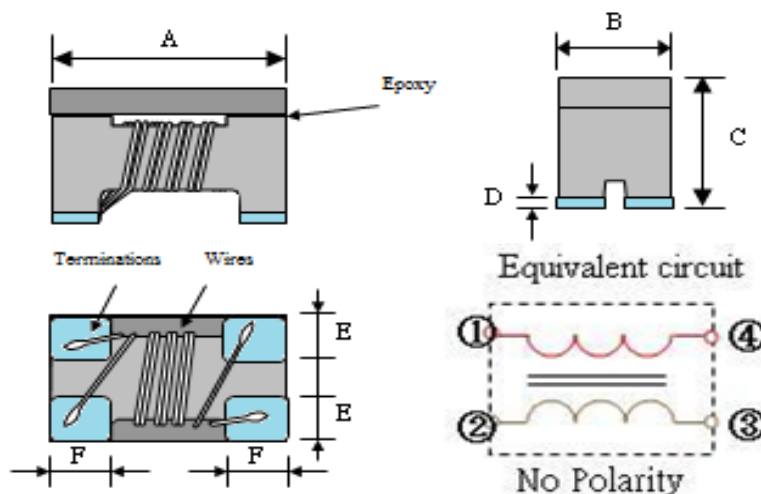

Fig.4-1

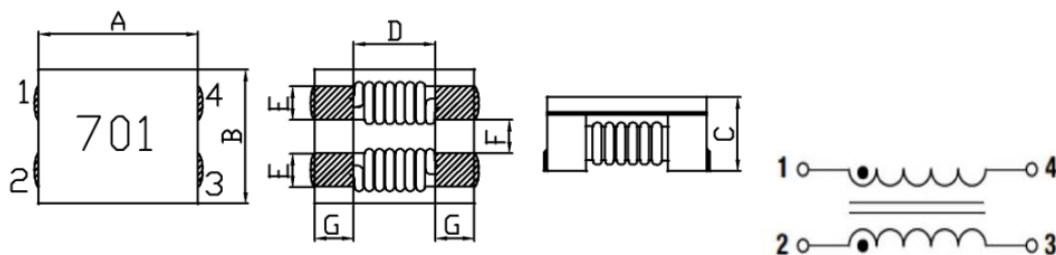

Fig.4-2

Unit: mm

Type	A	B	C	D	E	F	shape
CMF1210	1.2 ± 0.2	1.0 ± 0.2	0.9 max.	0.15 max.	0.36 Typ.	0.33 Typ.	Fig.4-1
CMF1608	1.6 ± 0.1	0.8 ± 0.1	1.1 ± 0.1	0.1 ± 0.1	0.25 Typ.	0.33 Typ.	Fig.4-1
CMF2012	2.0 ± 0.2	1.2 ± 0.2	1.2 ± 0.2	0.2 ± 0.1	0.40 Typ.	0.45 Typ.	Fig.4-1
CMF3216	3.2 ± 0.2	1.6 ± 0.2	1.9 ± 0.2	0.2 ± 0.1	0.60 Typ.	0.60 Typ.	Fig.4-1
CMF3225	3.2 ± 0.2	2.5 ± 0.2	2.2 ± 0.2	0.2 ± 0.1	0.80 Typ.	0.65 Typ.	Fig.4-1
CMF4532	4.5 ± 0.2	3.2 ± 0.2	2.8 ± 0.2	0.2 ± 0.1	1.2Typ.	1.0Typ.	Fig.4-1
CMF7060	7.0 ± 0.5	6.0 ± 0.5	3.8 max	3.5 Typ.	1.5 ± 0.2	1.5 ± 0.2	Fig.4-2
CMF9070	9.0 ± 0.5	7.0 ± 0.5	4.8 max	5.7 Typ.	1.5 ± 0.2	2.0 ± 0.2	Fig.4-2

5 特性参数 SPECIFICATIONS

详见附录 A。Please refer to Appendix A.

工作温度范围 Operating temperature range: -40 °C ~ +85°C

储存温度范围 Storage temperature range: -10 20°C, 70% RH.

6 特性参考曲线 Characteristic Curve

详见附录 B。Please refer to Appendix B.

7 测试及可靠性 TESTING AND RELIABILITY

7.1 测试环境条件 Test Conditions

一般按照以下环境条件测试（有特殊要求的除外），：

Unless otherwise specified, the standard atmospheric conditions for measurement/test as:

a. 温度 Ambient Temperature: 20±15 °C

b. 湿度 Relative Humidity: 65±20%

c. 大气压 Air Pressure: 86 kPa to 106 kPa

如果对测试结果有疑义，可以按照以下条件复测：

If any doubt on the results, measurements/tests should be made within the following limits:

a. 温度 Ambient Temperature: 20±2 °C

b. 湿度 Relative Humidity: 65±5%

c. 大气压 Air Pressure: 86kPa to 106 kPa

7.2 测试及可靠性 Testing and reliability

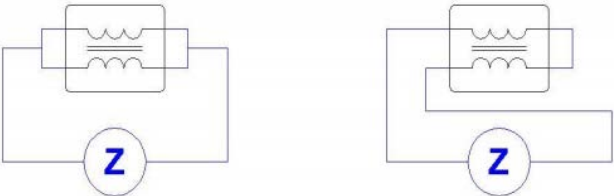
测试与可靠性 Testing and reliability	测试方法与要求 Test Methods and Remarks
直流电阻 RDC	a. 标准值参考第 5 章节附录 A。Refer to Item 5 Appendix A. b. 测试仪器：高精度电阻表 HP4338B 或等效仪器。Test equipment (Analyzer): High Accuracy Milliohmmeter-HP4338B or equivalent.
阻抗值 Impedance (Z)	a. 标准值参考第 5 章节附录 A。Refer to Item 5 Appendix A. b. 测试仪器：高精度射频阻抗分析仪 Anglient E4991A+HP16192A 或等效仪器。 Test equipment: High Accuracy RF Impedance /Material Analyzer -Anglient E4991A+ HP16192A or equivalent. c. 测试信号 Test signal: -40dBm or 100mV. d. 测试频率参考第 5 章节。Test frequency refers to Item 5. (A):Common mode (B):Differential mode 
额定电流 Rated Current (Ir)	a. 标准值参考第 5 章节。Refer to Item 5. b. 测试仪器：HP6632B 直流电源，数字点温计或等效仪器。 Test equipment: HP6632B system DC power supply, digital surface thermometer or equivalent. c. 额定电流 <1A, 温升 $\Delta T \leq 20^{\circ}\text{C}$; 额定电流 $\geq 1\text{A}$, 温升 $\Delta T \leq 40^{\circ}\text{C}$ 。Rated Current <1A, $\Delta T \leq 20^{\circ}\text{C}$; Rated Current $\geq 1\text{A}$, $\Delta T \leq 40^{\circ}\text{C}$.
可焊性 SOLDER - ABILITY	至少 95% 的焊接面完全被焊锡连续覆盖。95% min. coverage of all metabolised area. 焊锡温度 Solder temp. : $240 \pm 5^{\circ}\text{C}$ 浸入时间 Immersion time : 3 ± 1 sec 焊锡 Solder : Sn-3Ag-0.5Cu
耐焊性 RESISTANCE TO SOLDER HEAT	无可见损伤。电特性和机械特性满足产品规范或检验标准要求。No visible damage. Electrical characteristics and mechanical characteristics shall be satisfied. 焊锡温度 Solder Temp. : $265 \pm 3^{\circ}\text{C}$ 浸入时间 Immersion time : 6 ± 1 sec 预热 Preheating : 100 min @ 150°C , 1 mi 在室温下放置 24 ± 2 小时后测试检查。Measurement to be made after keeping at room temp for 24 ± 2 hrs. 焊锡 Solder : Sn-3Ag-0.5Cu
振动 Vibration	a. 试验要求 Performance specification 1) 外观 Appearance: 无可见机械损伤 no mechanical damage 2) 阻抗值变化应在 $\pm 20\%$ 以内 Impedance shall be with $\pm 20\%$ of the initial value b. 试验条件 Test condition 1) 波形 Waveform: 正弦波 Sine wave 2) 频率 Frequency: 10~55~10 Hz 3) 持续时间 Sweep time: 1min 4) Amplitude: 1.5mm(peak-peak) 5. Direction: X, Y, Z (3 axes) 6. Duration: 2 hrs./axis, total 6 hrs.
温度冲击 Temperature shock	a. 试验要求 Performance specification 1) 外观 Appearance: 无可见机械损伤 no mechanical damage 2) 阻抗值变化应在 $\pm 20\%$ 以内 Impedance shall be with $\pm 20\%$ of the initial value b. 试验条件 Test condition 1) 温度 Temperature : -40 $^{\circ}\text{C}$ 保持 30 分钟。 -40 $^{\circ}\text{C}$ 2) 周期 Cycle: 50 次。 50 cycles. 3) 检查 Measurement: 试验后至少在室温条件下放置 24 小时以上。 After placing at room ambient

<p>湿热负载 HUMIDITY RESISTANCE</p>	<p>temperature for 24 hours minimum.</p> <p>a. 试验要求 Performance specification</p> <p>1) 外观 Appearance: 无可见机械损伤 no mechanical damage</p> <p>2) 阻抗值变化应在±20%以内 Impedance shall be with ±20 % of the initial value</p> <p>b. 试验条件 Test condition</p> <p>1) 湿度 Humidity: 90 to 95 %RH</p> <p>2) 温度 Temperature: 60±2 °C</p> <p>3) 加载电流 Applied current: 额定直流电流 Rated current</p> <p>4) 试验时间 Testing time: 168 (+48,0) hours</p> <p>5) 检查 Measurement: 试验后至少在室温条件下放置 24 小时以上。After placing at room ambient temperature for 24 hours minimum.</p>																
<p>高温负载 HIGH TEMPERATURE RESISTANCE</p>	<p>a. 试验要求 Performance specification</p> <p>1) 外观 Appearance: 无可见机械损伤 no mechanical damage</p> <p>2) 阻抗值变化应在±20%以内 Impedance shall be with ±20 % of the initial value</p> <p>b. 试验条件 Test condition</p> <p>1) 温度 Temperature: +85 °C±2°C</p> <p>2) 加载电流 Applied current: 额定直流电流 Rated current</p> <p>3) 试验时间 Testing time: 168 (+48,0) hours</p> <p>4) 检查 Measurement: 试验后至少在室温条件下放置 24 小时以上。After placing at room ambient temperature for 24 hours minimum.</p>																
<p>低温储存 LOW TEMPERATURE STORAGE LIFE</p>	<p>a. 试验要求 Performance specification</p> <p>1) 外观 Appearance: 无可见机械损伤 no mechanical damage.</p> <p>2) 阻抗值变化应在±20%以内 Impedance shall be with ±20 % of the initial value.</p> <p>b. 试验条件 Test condition</p> <p>1. 温度 Temperature: -40 °C±2°C</p> <p>2. 试验时间 Testing time: 168 (+48,0) hours</p> <p>3. 检查 Measurement: 试验后至少在室温条件下放置 24 小时以上。After placing for 24 hours minimum at room ambient temperature.</p>																
<p>端头强度 TERMINAL STRENGTH</p>	<p>无破损现象。Without deformation cases.</p> <p>阻抗值变化应在±20%以内。Impedance shall be satisfied ± 20%.</p> <p>直流电阻应满足标准要求。DC resistance shall be satisfied.</p> <p>焊接在 PCB 上的产品应持续推力共 10 秒。Solder chip on PCB and applied 10N(1.02Kgf) for 10 sec.</p> <table border="1" data-bbox="403 1395 1441 1462"> <tr> <td>1210</td> <td>1608</td> <td>2012</td> <td>3216</td> <td>3225</td> <td>4532</td> <td>7060</td> <td>9070</td> </tr> <tr> <td>0.2kg</td> <td>0.5kg</td> <td>0.5kg</td> <td>1.0kg</td> <td>1.0kg</td> <td>1.0kg</td> <td>1.0kg</td> <td>1.0kg</td> </tr> </table> 	1210	1608	2012	3216	3225	4532	7060	9070	0.2kg	0.5kg	0.5kg	1.0kg	1.0kg	1.0kg	1.0kg	1.0kg
1210	1608	2012	3216	3225	4532	7060	9070										
0.2kg	0.5kg	0.5kg	1.0kg	1.0kg	1.0kg	1.0kg	1.0kg										
<p>跌落 Drop</p>	<p>试验后产品应无失效现象。Products shall be no failure after test.</p> <p>产品跌落在混凝土地面或钢板上。It shall be dropped on concrete or steel board.</p> <p>试验方法: 自由落下。Method : free fall.</p> <p>高度 Height : 100cm.</p> <p>产品跌落方向: 3 个方向。Attitude from which the product is dropped : 3 direction.</p> <p>总次数: 每个方向 3 次 (共 9 次)。The number of times : 3 times for each direction (Total 9 times).</p>																

8 包装及储存 Packaging, Storage

8.1 包装 Packaging

(1) 载带尺寸 Tape Dimensions(Unit: mm)

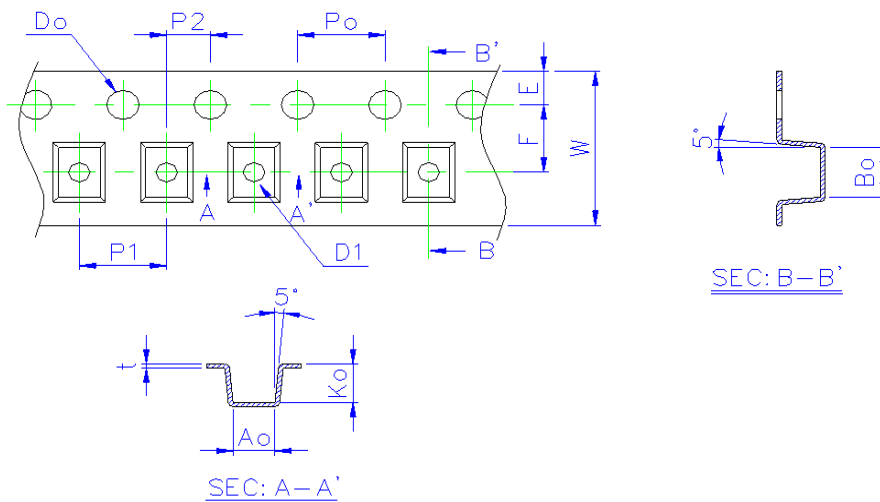

Size	Ao(mm)	Bo(mm)	Ko(mm)	W(mm)	E(mm)	F(mm)	Po(mm)	P1(mm)	Do(mm)
1210	1.15±0.10	1.40±0.10	0.93±0.10	8.00±0.20	1.75±0.10	3.50±0.05	4.0±0.05	4.0±0.10	1.5+0.1,-0
1608	1.65±0.10	1.00±0.10	1.18±0.10	8.00±0.20	1.75±0.10	3.50±0.05	4.0±0.05	4.0±0.10	1.5+0.1,-0
2012	2.35±0.10	1.50±0.10	1.45±0.10	8.00±0.20	1.75±0.10	3.50±0.05	4.0±0.05	4.0±0.10	1.5+0.1,-0
3216	3.50±0.10	1.88±0.10	2.10±0.10	8.00±0.20	1.75±0.10	3.50±0.05	4.0±0.05	4.0±0.10	1.5+0.1,-0
3225	2.80±0.10	3.60±0.10	2.20±0.10	8.00±0.20	1.75±0.10	3.50±0.05	4.0±0.05	4.0±0.10	1.0±0.1
4532	3.45±0.10	4.90±0.10	3.05±0.10	12.00±0.20	1.75±0.10	5.50±0.05	4.0±0.05	8.0±0.10	1.5+0.1,-0
9070	7.60±0.10	9.60±0.10	5.10±0.10	24.00±0.30	/	/	4.0±0.05	16.0±0.10	1.5+0.1,-0

(2) 卷盘 REEL

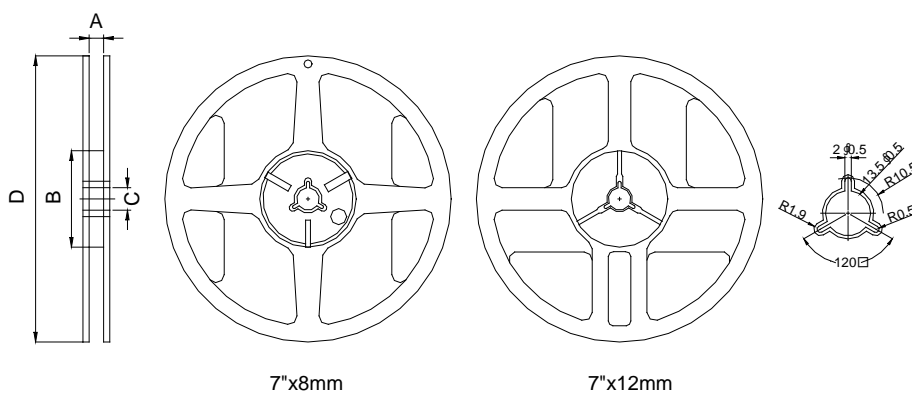

Type	A(mm)	B(mm)	C(mm)	D(mm)
7"x8mm	9.0±0.5	60±2	13.5±0.5	178±2
7"x12mm	13.5±0.5	60±2	13.5±0.5	178±2
13"x24mm	24.4±1.0	100±2	13.5±0.5	330±2

型号 Type	载带 Tape	数量 Quantity
CMF1210	Embossed Tape	3K
CMF1608	Embossed Tape	2K
CMF2012	Embossed Tape	2K
CMF3216	Embossed Tape	2K
CMF3225	Embossed Tape	1K
CMF4532	Embossed Tape	0.5K
CMF7060	Embossed Tape	1.5K
CMF9070	Embossed Tape	0.7K

(3) 剥离力 PEELING OFF FORCE

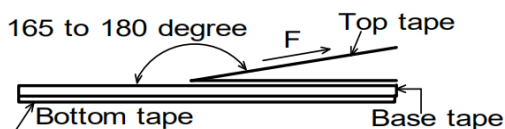

剥离速度 Speed of peeling off	300mm/s
剥离力 Peeling off force	0.1N to 1N(10g to 100g).

(4) 包装 Packaging

- 卷盘和干燥剂一同放入尼龙或塑料袋中。Reel and a bag of desiccant shall be packed in Nylon or plastic bag.
- 每个内盒中最多装 2 个上述袋子。Maximum of 2 bags shall be packaged in a inner box.
- 每个外箱中最多装 8 个内盒。Maximum of 8 inner box shall be packaged in a outer box.

8.2 储存 Storage

8.2.1 不得暴露在高温高湿环境下储存，否则导致产品外电极和焊接性恶化变差。建议包装好的产品储存在低于 40 °C 小于 70% RH 条件下。The solderability of the external electrode may be deteriorated if packages are stored where they are exposed to high humidity. Packages must be stored at 40 °C RH less and 70

8.2.2 不得暴露在灰尘或腐蚀性气体（如氯化氢，亚硫酸气体或硫化氢等）环境下储存，否则会导致产品外电极和焊接性恶化变差。The solderability of the external electrode may be deteriorated if packages are stored where they are exposed to dust or harmful gas (hydrogen chloride, sulfurous acid gas or hydrogen sulfide).

8.2.3 如果暴露在阳光直射或加热环境下储存，会导致包装材料变形。Packaging material may be deformed if packages are stored where they are exposed to heat or direct sunlight.

8.2.4 采用聚乙烯热封载带形式的最小包装，在使用之前不要拆开。如果拆开了，应尽快使用卷盘保护起来。Minimum packages, such as polyvinyl heat-seal packages shall not be opened until just before they are used. If opened, use the reels as soon as possible.

8.2.5 在符合 8.2.1 和 8.2.2 要求的环境下储存，从产品发货日期开始 6 个月内，产品的焊接性能够满足 7.2 规定的要求。Solderability specified in composite specification 7.2 shall be for 6 months from the date of delivery on condition that they are stored at the environment specified clause 8.2.1 & 8.2.2.

在产品使用之前，如果储存期超过 6 个月，则需要复检焊接性。For those parts which passed more than 6 months shall be checked solderability before it is used.

9 安装使用及注意事项

9.1 回流焊条件 Reflow soldering conditions

焊接之前产品应预热到 150 °C 焊接后应冷却到 100 °C Pre-heating should be in such a way that the

temperature difference between solder and ferrite surface is limited to 150

°C max. Also

soldering should be in such a way that the temperature difference is limited to 100 °C max.

如果预热不充分,会导致产品质量恶化。Unenough pre-heating may cause cracks on the ferrite, resulting in the deterioration of product quality.

产品应当按照下述曲线焊接。Products should be soldered within the following allowable range indicated by the slanted line.

作业前,应对焊锡炉进行校准确认,保证能够符合焊接工艺条件。The excessive soldering conditions may cause the corrosion of the electrode, When soldering is repeated, allowable time is the accumulated time.

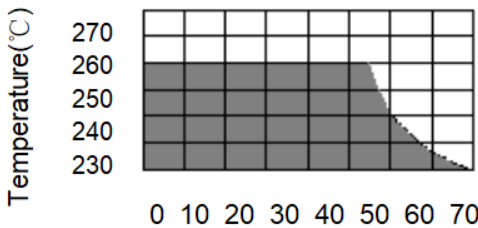

Temperature Profile

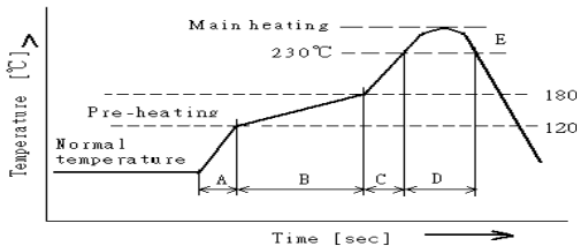

A	Slope of temp. rise	※ 1 to 5	※ °C/sec
B	Heat time	50 to 150	※ sec
	Heat temperature	120 to 180	※ °C
C	Slope of temp. rise	1 to 5	※ °C/sec
D	Time over 230°C	90~120	※ sec
E	Peak temperature	255~260	※ °C
	Peak hold time	10 max.	※ sec
※ No. of mounting		3	※ times

9.2 返工 Reworking with soldering iron

预热 Preheating	150°C, 1 minute
最高温度 Tip temperature	280°C max
焊接时间 Soldering time	3seconds max.
电烙铁输出功率 Soldering iron output	30w max.
电烙铁焊头尺寸 End of soldering iron	φ 3mm max.

*返工仅限一次。Reworking should be limited to only one time.

注意 Note: 为了避免焊接高温冲击导致产品本体开裂,电烙铁焊头焊锡时应避免直接与产品接触。Do not directly touch the products with the tip of the soldering iron in order to prevent the crack on the ferrite material due to the thermal shock.

9.3 焊料量 Solder Volume

焊料使用时,不得超过如下所示的上限要求。Solder shall be used not to be exceed the upper limits as shown below.

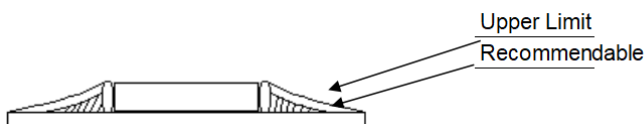



深圳市宏业兴电子有限公司

Shenzhen HongyeX Electronics Co.,Ltd.

文件编号 Document number: HYSP-CM000XX

版本编码 Version number: B1

随着焊料的增加，产品承受的机械应力也随之增加。过量的焊料所产生的机械应力，会导致产品出现机械或电气特性失效。Accordingly increasing the solder volume, the mechanical stress to product is also increased. Exceeding solder volume may cause the failure of mechanical or electrical performance.

附录 A 电气特性表
Appendix A Electrical Characteristics

CMF1210Series

Part Number	Impedance @100MHz	Max.DC resistance	Max.rated Current	Rated Voltage	Insolation Resistance Min.
Unit	$\Omega \pm 25\%$	Ω	mA	V	M Ω
Symbol	Z	DCR	Ir	Ur	Ir
CMF1210F-670-2P-T	67	0.4	300	50	10
CMF1210F-900-2P-T	90	0.5	280	50	10
CMF1210F-121-2P-T	120	0.55	270	50	10
CMF1210F-161-2P-T	160	0.58	260	50	10
CMF1210F-181-2P-T	180	0.6	260	50	10
CMF1210F-251-2P-T	250	0.7	230	50	10
CMF1210F-331-2P-T	330	0.8	200	50	10

CMF1608Series

Part Number	Impedance @100MHz	Max.DC resistance	Max.rated Current	Rated Voltage	Insolation Resistance Min.
Unit	$\Omega \pm 25\%$	Ω	mA	V	M Ω
Symbol	Z	DCR	Ir	Ur	Ir
CMF1608F-670-2P-T	67	0.3	300	50	10
CMF1608F-900-2P-T	90	0.3	300	50	10
CMF1608F-121-2P-T	120	0.36	250	50	10
CMF1608F-161-2P-T	160	0.4	200	50	10
CMF1608F-221-2P-T	220	0.42	200	50	10

CMF2012Series

Part Number	Impedance @100MHz	Max.DC resistance	Max.rated Current	Rated Voltage	Insolation Resistance Min.
Unit	$\Omega \pm 25\%$	Ω	mA	V	M Ω
Symbol	Z	DCR	Ir	Ur	Ir
CMF2012F-670-2P-T	67	0.25	400	50	10
CMF2012F-900-2P-T	90	0.3	400	50	10
CMF2012F-121-2P-T	120	0.3	350	50	10
CMF2012F-161-2P-T	160	0.3	350	50	10
CMF2012F-181-2P-T	180	0.35	330	50	10
CMF2012F-221-2P-T	220	0.35	330	50	10
CMF2012F-261-2P-T	260	0.4	300	50	10
CMF2012F-361-2P-T	360	0.4	280	50	10

CMF3216Series

Part Number	Impedance @100MHz	Max.DC resistance	Max.rated Current	Rated Voltage	Insolation Resistance Min.
Unit	$\Omega \pm 25\%$	Ω	mA	V	M Ω
Symbol	Z	DCR	Ir	Ur	Ir
CMF3216F-670-2P-T	67	0.25	400	50	10
CMF3216F-900-2P-T	90	0.3	400	50	10
CMF3216F-121-2P-T	120	0.35	370	50	10
CMF3216F-161-2P-T	160	0.4	340	50	10
CMF3216F-261-2P-T	260	0.5	310	50	10
CMF3216F-601-2P-T	600	0.8	260	50	10
CMF3216F-102-2P-T	1000	1	230	50	10
CMF3216F-222-2P-T	2200	1.2	200	50	10

CMF3225Series

Part Number	Impedance @100MHz	Max.DC resistance	Max.rated Current	Rated Voltage	Insolation Resistance Min.
Unit	$\Omega \pm 25\%$	Ω	mA	V	M Ω
Symbol	Z	DCR	Ir	Ur	Ir
CMF3225F-800-2P-T	80	0.15	2000	50	10
CMF3225F-601-2P-T	600	0.25	1000	50	10
CMF3225F-102-2P-T	1000	0.35	1200	50	10

CMF4532Series

Part Number	Impedance @100MHz	Max.DC resistance	Max.rated Current	Rated Voltage	Insolation Resistance Min.
Unit	$\Omega \pm 25\%$	Ω	mA	V	M Ω
Symbol	Z	DCR	Ir	Ur	Ir
CMF4532F-800-2P-T	80	0.07	3000	50	10
CMF4532F-121-2P-T	120	0.07	3000	50	10
CMF4532F-201-2P-T	200	0.1	2000	50	10
CMF4532F-601-2P-T	600	0.3	1500	50	10
CMF4532F-801-2P-T	800	0.35	1000	50	10
CMF4532F-102-2P-T	1000	0.4	1000	50	10

CMF7060Series

Part Number	Impedance @100MHz		Max.DC resistance	Max.rated Current	Rated Voltage	Insolation Resistance Min.
Unit	Ω		Ω	mA	V	MΩ
Symbol	Z min.	Z typ.	DCR	Ir	Ur	Ir
CMF7060F-101-2P-T	100	140	0.010	9000	125	10
CMF7060F-301-2P-T	225	300	0.010	5000	125	10
CMF7060F-501-2P-T	350	500	0.010	5000	125	10
CMF7060F-601-2P-T	500	700	0.015	4000	125	10
CMF7060F-701-2P-T	500	700	0.015	4000	125	10
CMF7060F-102-2P-T	1000	1020	0.017	3000	80	10
CMF7060F-132-2P-T	910	1300	0.021	2500	80	10
CMF7060F-272-2P-T	2000	2700	0.063	1000	125	10

CMF9070Series

Part Number	Impedance		Max.DC resistance	Max.rated Current	Rated Voltage	Insolation Resistance Min.
	@100MHz					
Unit	Ω		Ω	mA	V	MΩ
Symbol	Z min.	Z typ.	DCR	Ir	Ur	Ir
CMF9070-301-2P-T	225	300	0.006	6000	50	10
CMF9070-501-2P-T	450	600	0.008	5500	50	10
CMF9070-701-2P-T	500	700	0.01	5000	50	10
CMF9070-102-2P-T	750	1000	0.013	4000	50	10
CMF9070-152-2P-T	600	1500	0.05	3000	50	10
CMF9070-202-2P-T	1500	2000	0.02	2500	50	10
CMF9070-222-2P-T	1700	2200	0.06	2500	50	10
CMF9070-272-2P-T	2000	2700	0.086	2000	50	10
CMF9070-302-2P-T	2100	3000	0.07	3000	80	10

附录 B 特性参考曲线

Appendix B Characteristics Curve

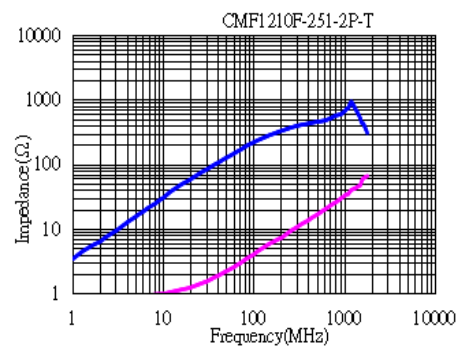
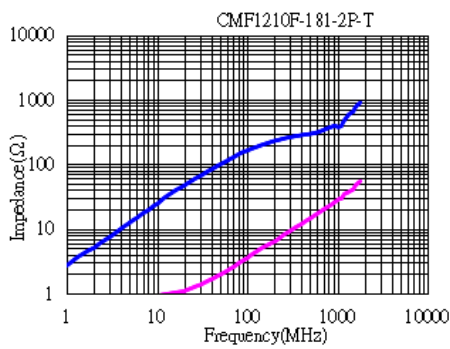
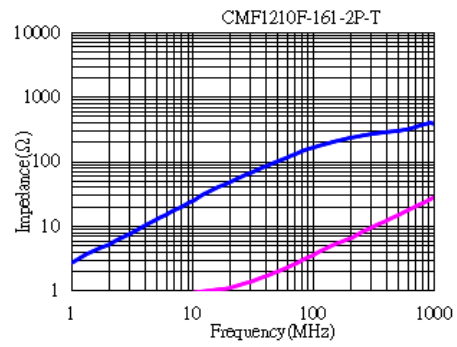
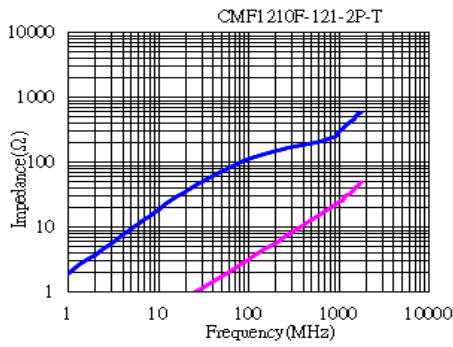
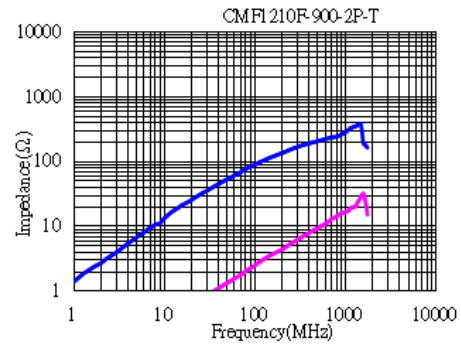
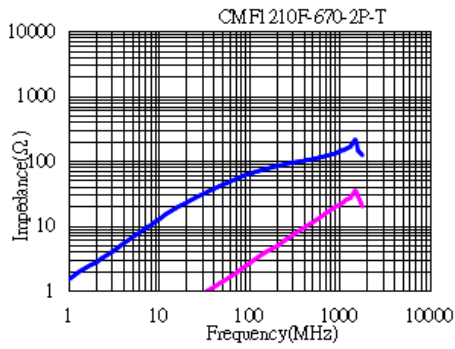

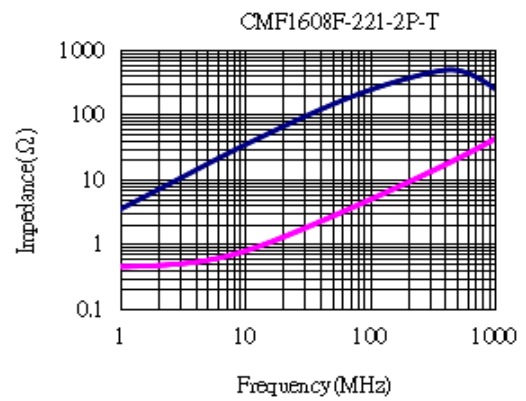
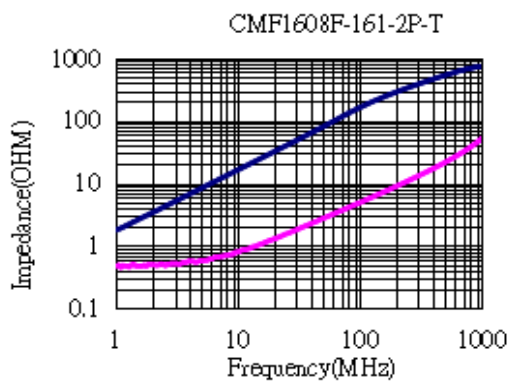
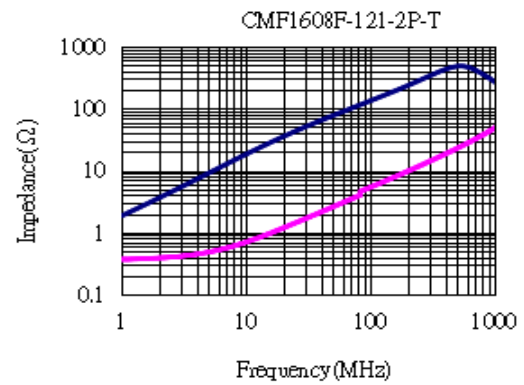
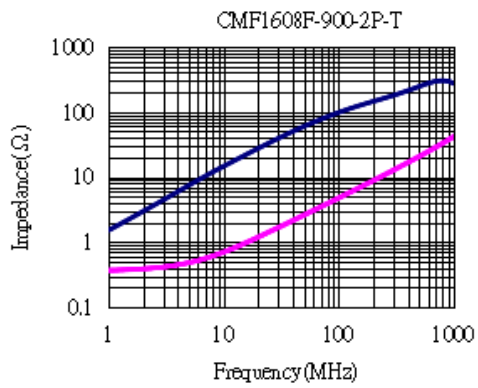
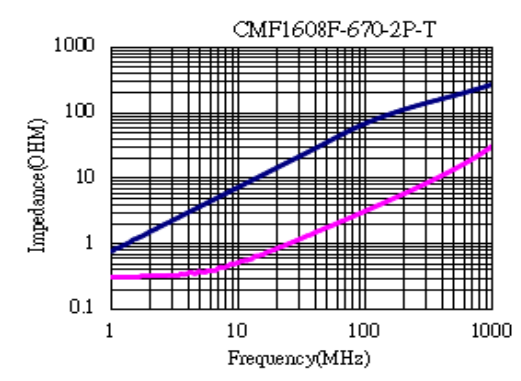
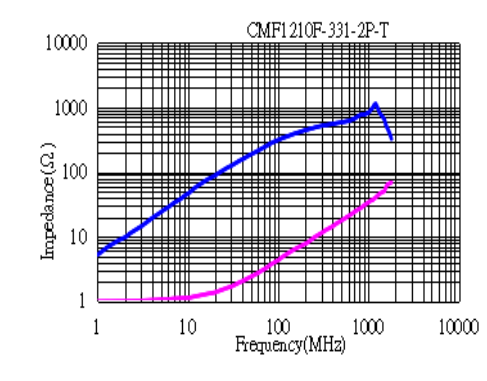

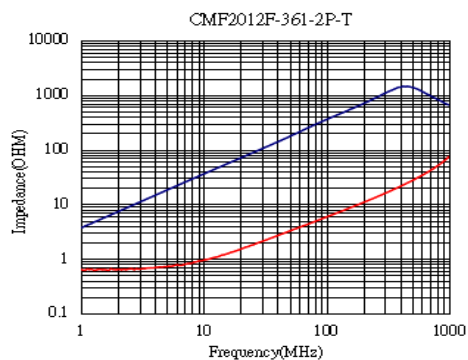
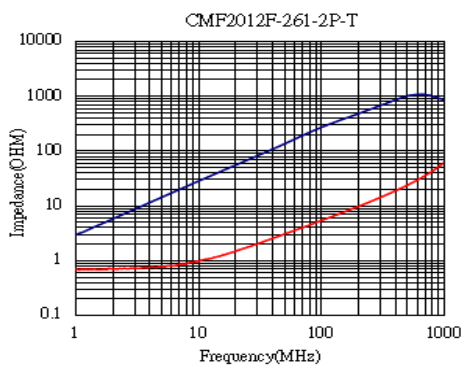
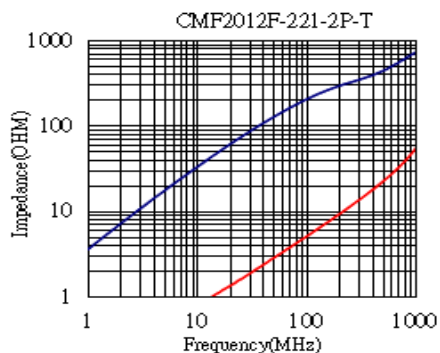
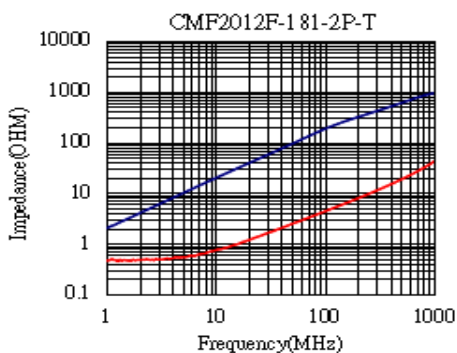
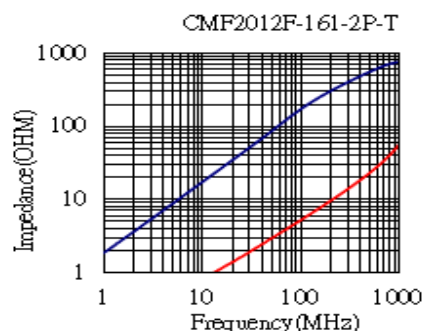
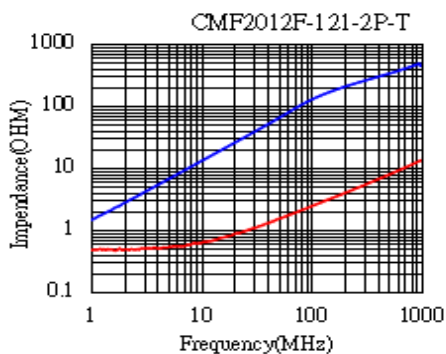
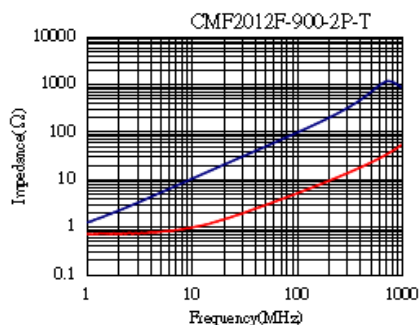
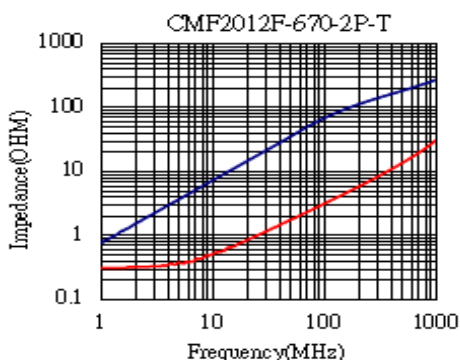

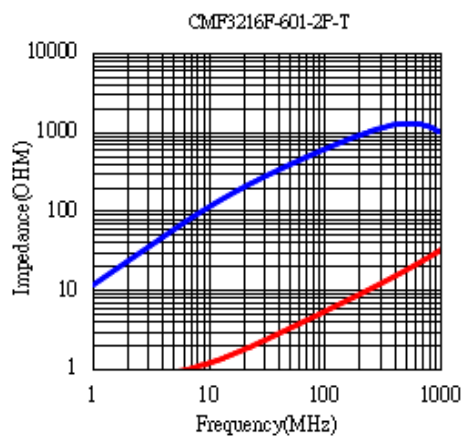
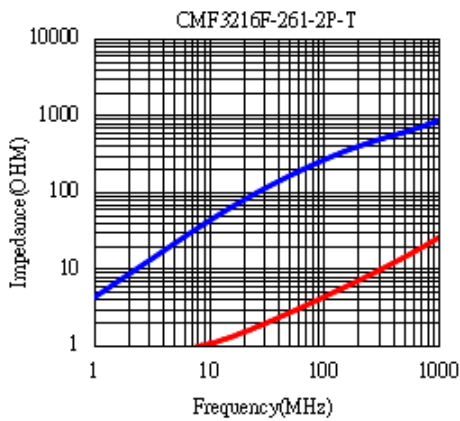
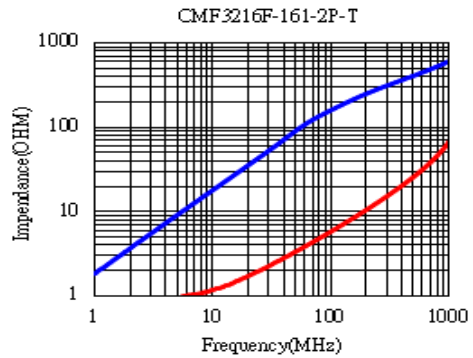
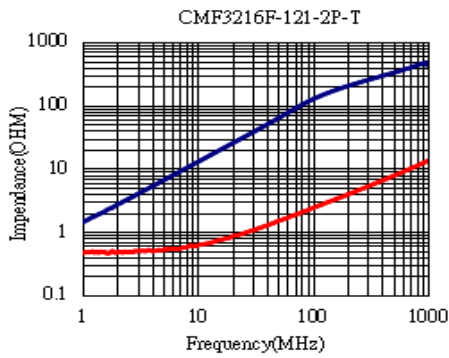
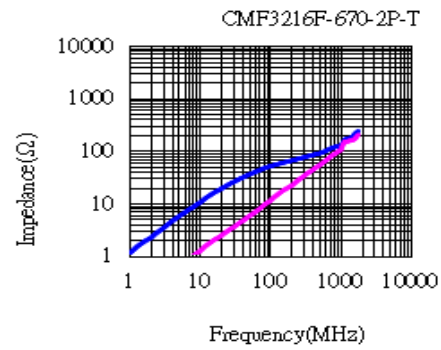
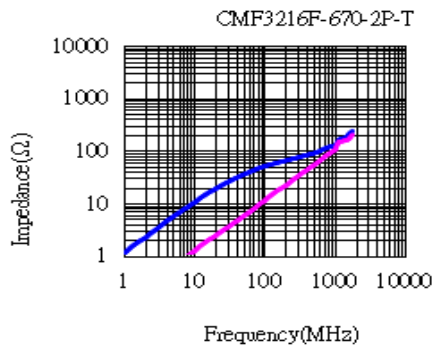

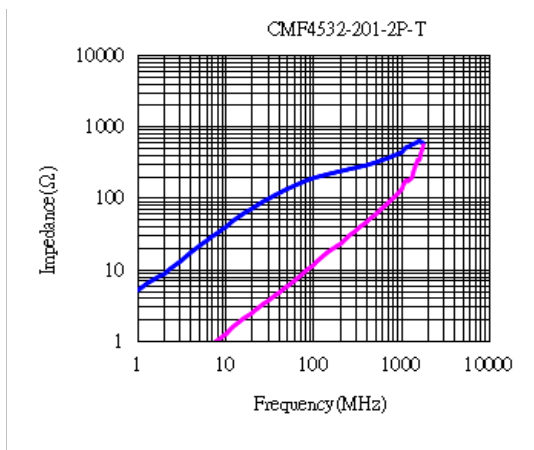
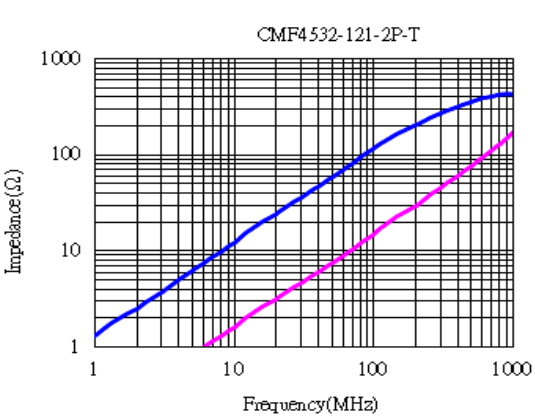
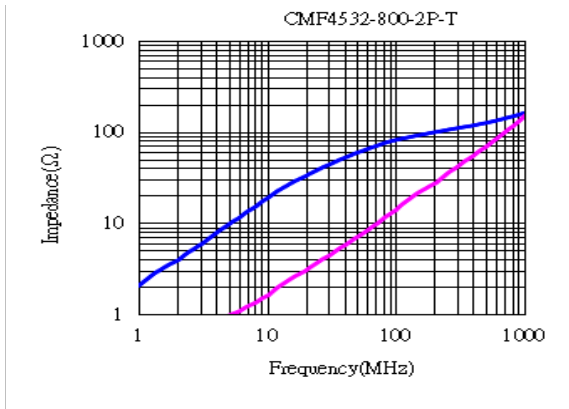
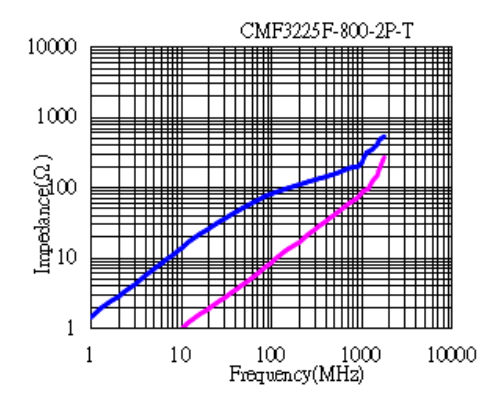
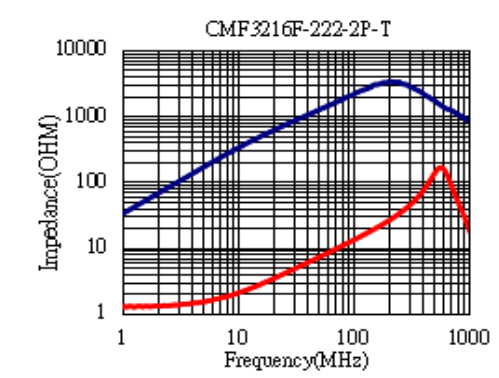
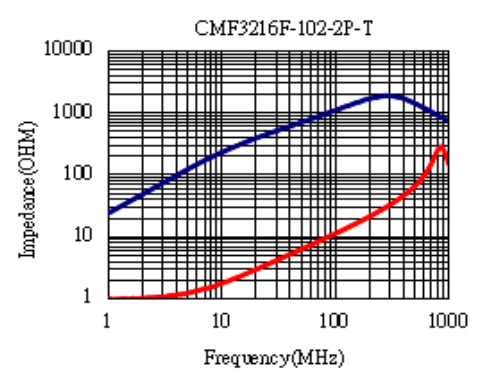

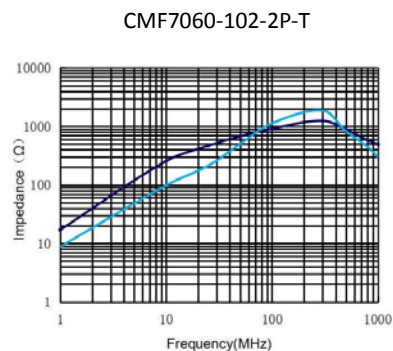
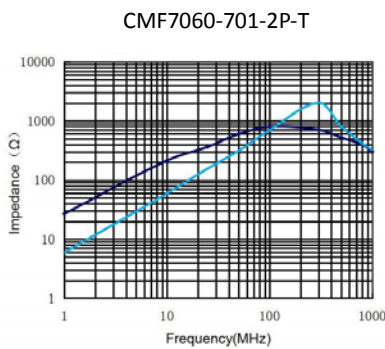
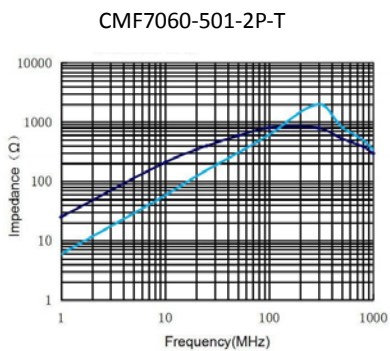
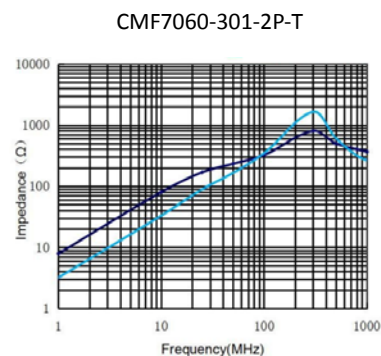
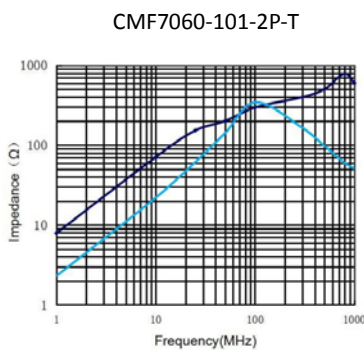
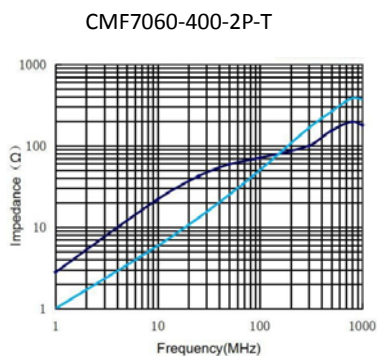
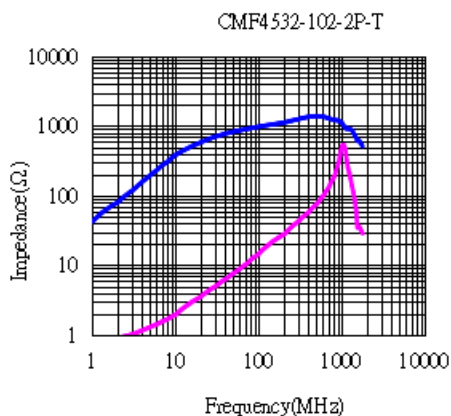
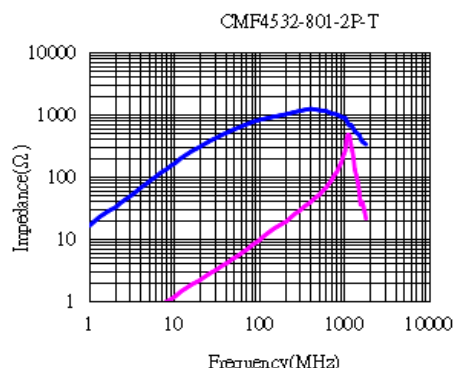
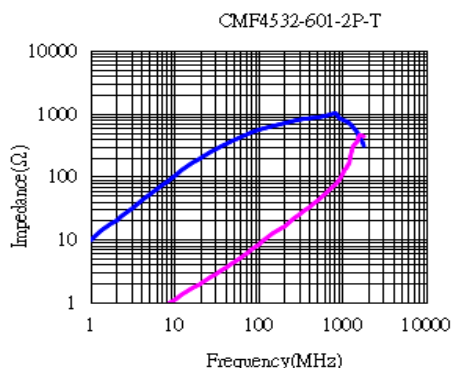

CMF7060-132-2P-T

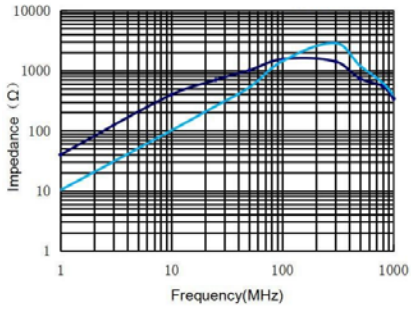

CMF7060-272-2P-T

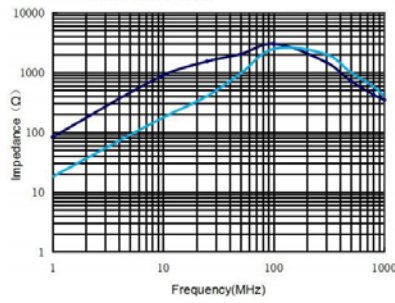

CMF7060-302-2P-T

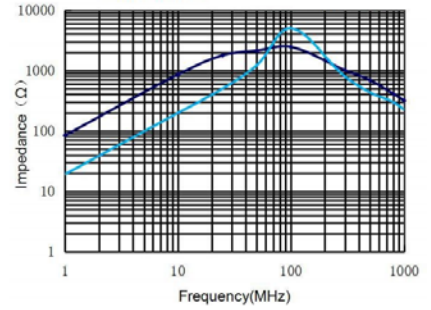

CMF9070-301-2P-T

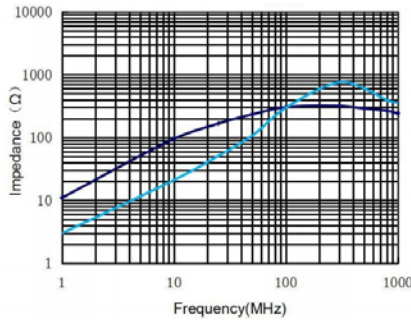

CMF9070-501-2P-T

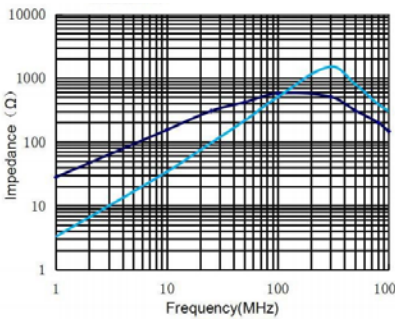

CMF9070-701-2P-T

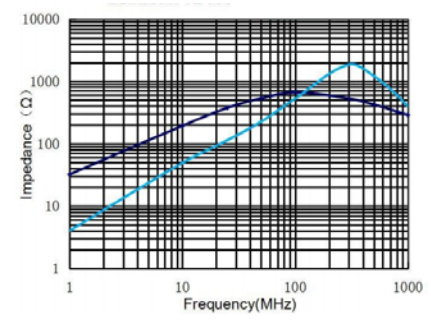

CMF9070-132-2P-T

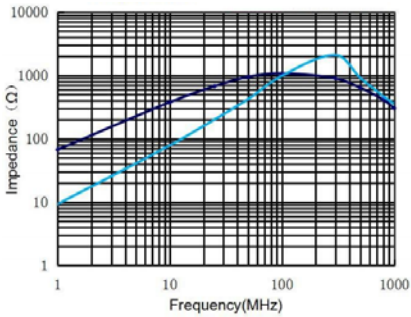

CMF9070-272-2P-T

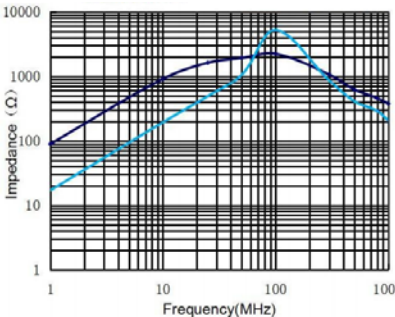

CMF9070-302-2P-T

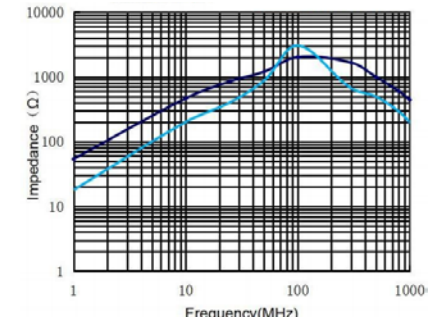

X-ON Electronics

Largest Supplier of Electrical and Electronic Components

Click to view similar products for [Common Mode Chokes / Filters](#) category:

Click to view products by [HYHONGYEX](#) manufacturer:

Other Similar products are found below :

[74279408](#) [PE-62911NL](#) [PE-64683](#) [RD5122-6-9M6](#) [RGCMF1210900H3T](#) [ST6118T-R](#) [FE3X025-10-7NL](#) [T8114NLT](#) [RD5122-10-6M0](#)
[TCM0806G-350-2P-T](#) [TCM0806G-650-2P-T](#) [IND-0110](#) [UAL21VR0802000](#) [UALSC023000000](#) [UALSC1020JH000](#) [UALSC1520JH000](#)
[UALSU10VR15019](#) [UALSU9VD070100](#) [36-00037](#) [5701610000](#) [UALW21HS200290](#) [UALW21HS072450](#) [UALSU9HF050500](#)
[UALSU9H0208000](#) [UAL24VK06450CH](#) [PLT10HH501100PNB](#) [PLT10HH401100PNB](#) [PLT10HH1026R0PNB](#) [PE-67531](#) [TLH10UB 113](#)
[OR5](#) [2752045447](#) [CMS3-11-R](#) [7351V](#) [7408-RC](#) [CMF16-153131](#) [744252510](#) [T8116NLT](#) [CMS2-10-R](#) [DLW44SN101SK2L](#) [FE2X10-4-2NL](#)
[744253200](#) [744253101](#) [744252220](#) [TX8111NLT](#) [UAL30VR3500470](#) [CTX01-19077-R](#) [T8003NLT](#) [CTX01-13663](#) [CTX66-19521-R](#)
[7446630047](#)