

COMPONENT SPECIFICATION

版次：第3版

NAME	MULTILAYER CHIP INDUCTORS	COMPOSITE SPECIFICATION		1/8
	EBLS-201212	SPEC#	EBLS2012-101K	

1. SCOPE

This specification applies to the EBLS-2012 series Multilayer Chip Inductors

2. STANDARD ATMOSPHERIC CONDITIONS

Unless otherwise specified the standard range of atmospheric conditions for making measurements and tests is as follows:

Ambient temperature : $20 \pm 15^\circ\text{C}$

Relative humidity : 30~70%

If there may be any doubt on the results, measurements shall be made within the following limits :

Ambient temperature : $25 \pm 5^\circ\text{C}$

Relative humidity : 30~70%

3. RATINGS

PART NO	INDUCTANCE	Q	SELF-RESONANT FREQUENCY(MHz)	DC RESISTANCE	RATED CURRENT
	AT 1 MHz 60mV	Min	Min	(Ω) Max	(mA)Max
EBLS2012-101K	$100 \mu\text{H} \pm 10\%$	25	7	3.1	2

4. DIMENSION

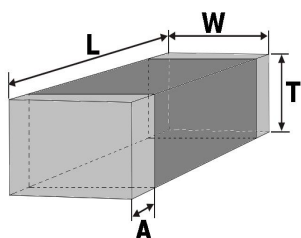

OPERATING TEMP. RANGE : $-40^\circ\text{C} \sim +85^\circ\text{C}$

STORAGE TEMP. RANGE : $-10^\circ\text{C} \sim +40^\circ\text{C}$

TYPE	L	W	T	A(m/m)
EBLS-2012	2.0 ± 0.2	1.25 ± 0.2	1.25 ± 0.2	0.2~0.8

HISTORY	DATE	REVISION		SIGN.	SIGN.
PLANNED BY	CHECKED BY	APPROVED BY			
JSHING	HSU	Chi Chi Huang			

COMPONENT SPECIFICATION

版次：第3版

N A M E	MULTILAYER CHIP INDUCTORS	COMPOSITE SPECIFICATION		2 / 8
	EBLS-201212	SPEC#	EBLS2012-101K	

INDUCTANCE VS DC SUPERPOSITION CHARACTERISTICS

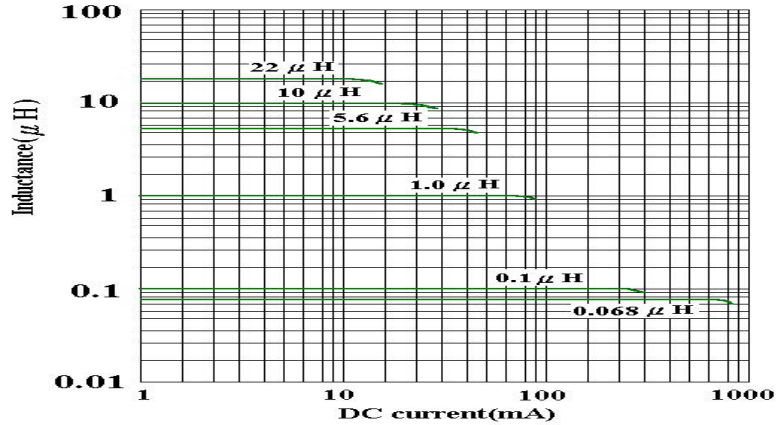

IMPEDANCE VS FREQUENCY CHARACTERISTICS

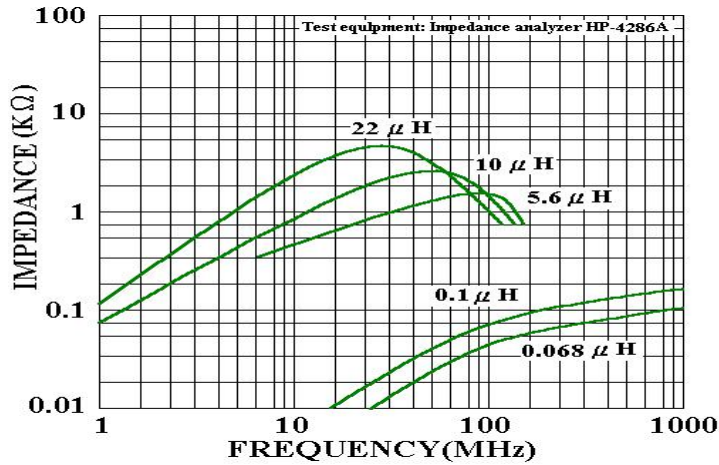

Q VS FREQUENCY CHARACTERISTICS

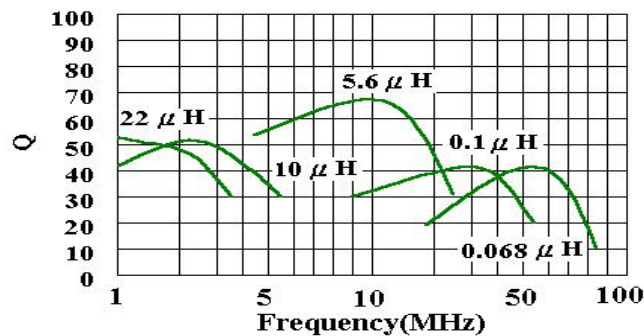

COMPONENT SPECIFICATION

版次：第3版

N A M E	MULTILAYER CHIP INDUCTORS	COMPOSITE SPECIFICATION		3 / 8
	EBLS-201212	SPEC#	EBLS2012-101K	

6) Reflow soldering conditions

- Pre-heating should be in such a way that the temperature difference between solder and ferrite surface is limited to 150°C max. Also cooling into solvent after soldering should be in such a way that the temperature difference is limited to 100°C max. Unenough pre-heating may cause cracks on the ferrite, resulting in the deterioration of product quality.
- Products should be soldered within the following allowable range indicated by the slanted line. The excessive soldering conditions may cause the corrosion of the electrode, When soldering is repeated, allowable time is the accumulated time.

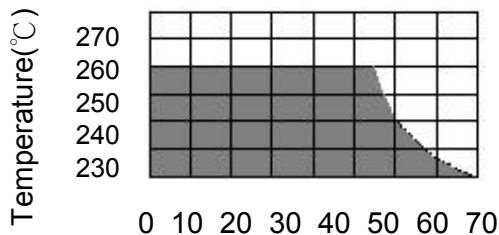

Temperature Profile

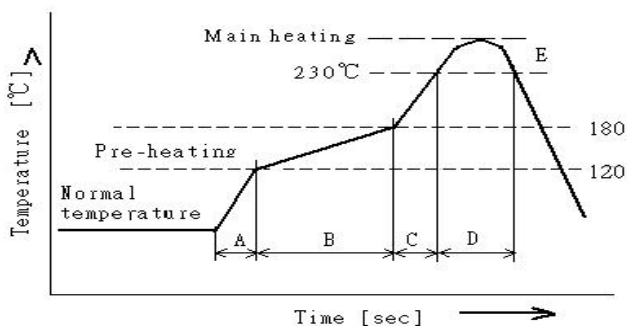

A	Slope of temp. rise	※ 1 to 5	※ °C/sec
B	Heat time	50 to 150	※ sec
	Heat temperature	120 to 180	※ °C
C	Slope of temp. rise	1 to 5	※ °C/sec
D	Time over 230°C	90~120	※ sec
E	Peak temperature	255~260	※ °C
	Peak hold time	10 max.	※ sec
※No. of mounting		3	※ times

(Melting area of solder)

6-1 Reworking with soldering iron

Preheating	150°C, 1minute
Tip temperature	280°C max
Soldering time	3seconds max.
Soldering iron output	30w max.
End of soldering iron	∅ 3mm max.

- Reworking should be limited to only one time.

Note : Do not directly touch the products with the tip of the soldering iron in order to prevent the crack on the ferrite material due to the thermal shock.

6-2 Solder Volume

Solder shall be used not to be exceed the upper limits as shown below.

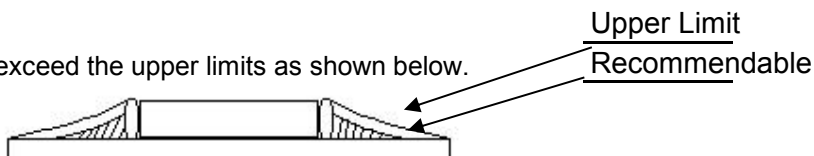

Accordingly increasing the solder volume, the mechanical stress to product is also increased. Exceeding solder volume may cause the failure of mechanical or electrical performance.

COMPONENT SPECIFICATION

版次：第3版

N A M E	MULTILAYER CHIP INDUCTORS	COMPOSITE SPECIFICATION	4 / 8
	EBLS-201212	SPEC# EBLS2012-101K	

7 EQUIPMENT

7-1 IMPEDANCE

Impedance shall be measured with HP – 4286A impedance analyzer or equivalent system

7-2 DC RESISTANCE

DC resistance shall be measured using HP 4338 digital milli – ohm meter with 4 terminal method.

8. MECHANICAL CHARACTERISTICS

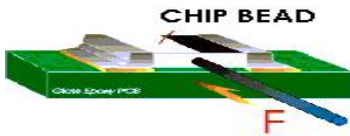
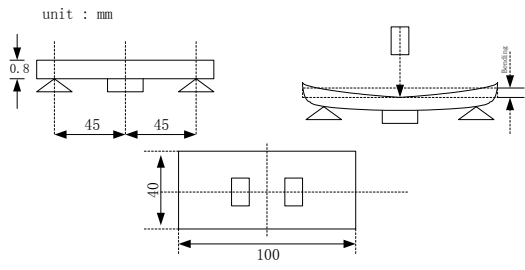
ITEM	Specification	TEST CONDITIONS
TERMINAL STRENGTH	Without deformation cases impedance shall be satisfied $\pm 20\%$ DC resistance shall be satisfied.	Solder chip on PCB and applied 10N (1.02Kgf) for 10 sec 
Substrate bending test	Without deformation cases, inductance shall be satisfied $\pm 20\%$ DC resistance shall be satisfied.	After soldering a chip to a test substrate, bend the substrate by 3mm hold for 10s and then return. Soldering shall be done in accordance with the recommended PC board pattern and reflow soldering. 
RESISTANCE TO SOLDER HEAT	No visible damage Electrical characteristics and mechanic characteristics shall be satisfied. Consult standard MIL-STD-202 METHOD 210	Solder Temp. : $265\pm 3^{\circ}\text{C}$ Immersion time : 6 ± 1 sec Preheating : 100°C to 150°C , 1 minute. Measurement to be made after keeping at room temp for 24 ± 2 hrs. Solder : Sn-3Ag-0.5Cu
SOLDER – ABILITY	95% min. coverage of all metabolised area Consult standard J-STD-002	Solder temp. : $240\pm 5^{\circ}\text{C}$ Immersion time : 3 ± 1 sec Solder : Sn-3Ag-0.5Cu

COMPONENT SPECIFICATION

版次：第3版

N A M E	MULTILAYER CHIP INDUCTORS	COMPOSITE SPECIFICATION		5 /
	EBLS-201212	SPEC#	EBLS2012-101K	
<p>9. RELIABILITY AND TEST CONDITIONS</p> <p>9-1 HIGH TEMPERATURE RESISTANCE</p> <p style="margin-left: 20px;">a. Performance specification</p> <p style="margin-left: 40px;">1.Appearance : no mechanical damage</p> <p style="margin-left: 40px;">2.Inductance shall be with $\pm 20\%$ of the initial value</p> <p style="margin-left: 20px;">b.Test condition</p> <p style="margin-left: 40px;">1.Temperature $+85^{\circ}\text{C} \pm 2^{\circ}\text{C}$</p> <p style="margin-left: 40px;">2.Applied current : Rated current</p> <p style="margin-left: 40px;">3.Testing time : 1008 ± 12hrs (maximum value)</p> <p style="margin-left: 40px;">4.Measurement : After placing at room ambient temperature for 24 hours minimum</p> <p>9-2 HUMIDITY RESISTANCE</p> <p style="margin-left: 20px;">a.Performance specification</p> <p style="margin-left: 40px;">1.Appearance : no mechanical damage</p> <p style="margin-left: 40px;">2.Inductance shall be with $\pm 20\%$ of the initial value</p> <p style="margin-left: 20px;">b.Test condition</p> <p style="margin-left: 40px;">1.Humidity : 90 to 95% RH</p> <p style="margin-left: 40px;">2.Temperature : $60 \pm 2^{\circ}\text{C}$</p> <p style="margin-left: 40px;">3.Applied current : Rated current (maximum value)</p> <p style="margin-left: 40px;">4.Testing time : 1008 ± 12hours</p> <p style="margin-left: 40px;">5.Measurement : After placing at room ambient temperature for 24 hours minimum</p> <p>9-3 TEMPERATURE CYCLE</p> <p style="margin-left: 20px;">a.Performance specification</p> <p style="margin-left: 40px;">1.Appearance : no mechanical damage</p> <p style="margin-left: 40px;">2.Inductance shall be with $\pm 20\%$ of the initial value</p> <p style="margin-left: 20px;">b.Test condition</p> <p style="margin-left: 40px;">1.Temperature $-40^{\circ}\text{C}, +85^{\circ}\text{C}$ kept stabilized for 30 minutes each</p> <p style="margin-left: 40px;">2.Cycle : 100 cycles</p> <p style="margin-left: 40px;">3.Measurement : After placing for 24hours minimum at room ambient temperature</p> <p style="margin-left: 40px;">4. step1. -40°C temp$\pm 3^{\circ}\text{C}$ 30± 3 minutes</p> <p style="margin-left: 80px;">step2. Room temperature 2to5 minutes</p> <p style="margin-left: 80px;">step3. $+85^{\circ}\text{C}$ temp$\pm 2^{\circ}\text{C}$ 30± 3 minutes</p> <p style="margin-left: 80px;">step4. room temperature 2to5 minutes</p> <p>9-4 LOW TEMPERATURE STORAGE LIFE TEST</p> <p style="margin-left: 20px;">a.Performance specification</p> <p style="margin-left: 40px;">1.Appearance : no mechanical damage</p> <p style="margin-left: 40px;">2.Inductance shall be with $\pm 20\%$ of the initial value</p> <p style="margin-left: 20px;">b.Test condition</p> <p style="margin-left: 40px;">1.Temperature $-40^{\circ}\text{C} \pm 2^{\circ}\text{C}$</p> <p style="margin-left: 40px;">2.Testing time : 1008 ± 12hours</p> <p style="margin-left: 40px;">3.Measurement : After placing for 24 hours minimum at room ambient temperature</p> <p>9-5 THERMAL SHOCK</p> <p style="margin-left: 20px;">a.Performance specification</p> <p style="margin-left: 40px;">1.Appearance : no mechanical damage</p> <p style="margin-left: 40px;">2.Inductance shall be with $\pm 20\%$ of the initial value</p> <p style="margin-left: 20px;">b.Test condition</p> <p style="margin-left: 40px;">1.Temperature $-40^{\circ}\text{C}, +85^{\circ}\text{C}$ kept stabilized for 30 minutes each</p> <p style="margin-left: 40px;">2.Cycle : 100 cycles</p> <p style="margin-left: 40px;">3.Measurement : After placing for 24 hours minimum at room ambient temperature</p> <p>9-6 VIBRATION TEST</p> <p style="margin-left: 20px;">a.Performance specification</p> <p style="margin-left: 40px;">1.Appearance : no mechanical damage</p> <p style="margin-left: 40px;">2.Inductance shall be with $\pm 20\%$ of the initial value</p> <p style="margin-left: 20px;">b.Test condition</p> <p style="margin-left: 40px;">1.Waveform:Sine wave</p> <p style="margin-left: 40px;">2.Frequency:10~55~10 Hz</p> <p style="margin-left: 40px;">3.Sweep time:1min</p> <p style="margin-left: 40px;">4.Amplitude:1.5mm(peak-peak)</p> <p style="margin-left: 40px;">5.Direction:X,Y,Z(3 axes)</p> <p style="margin-left: 40px;">6.Duration:2 hrs./axis,total 6 hrs.</p>				

COMPONENT SPECIFICATION

版次：第3版

NAME	MULTILAYER CHIP INDUCTORS	COMPOSITE SPECIFICATION		6 / 8
	EBLS-201212	SPEC#	EBLS2012-101K	

10. EMBOSSED CARRIER TAPE PACKAGING

10-1 DIMENSIONS

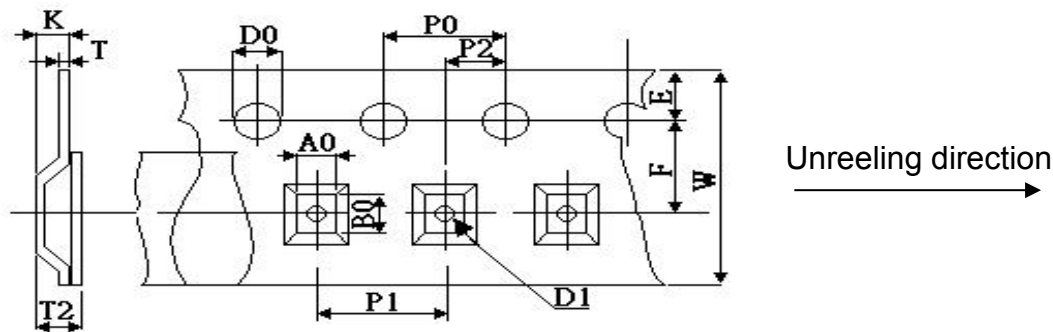

A0	B0	W	F	E	P1	P2	P0	D0	D1	K	T	T2
1.5	2.35	8.0	3.5	1.75	4.0	2.00	4.0	1.55	1.00	1.67	0.22	1.67
±0.1	±0.1	±0.1	±0.05	±0.1	±0.1	±0.05	±0.1	±0.05	±0.1	±0.15	±0.05	±0.25

10-2 LEADER AND TRAILER TAPE

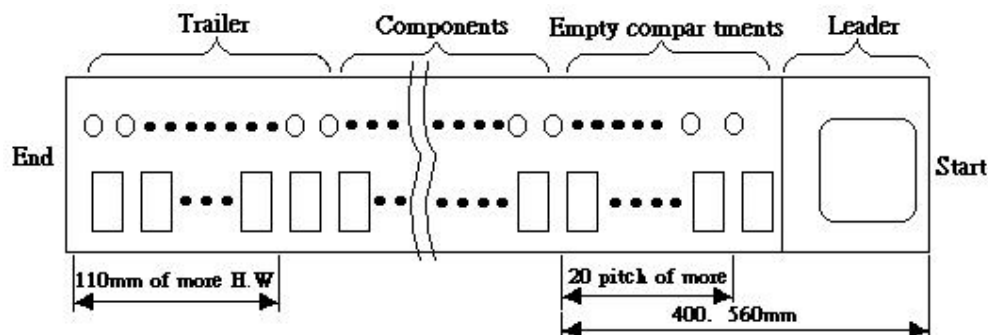

10-3 DIRECTION THE DIRECTION SHALL BE SEEN FROM THE TOP OF COVER TAPE



10-4 REELS

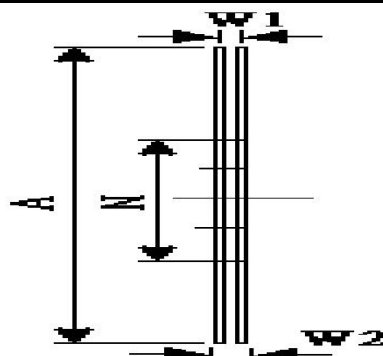
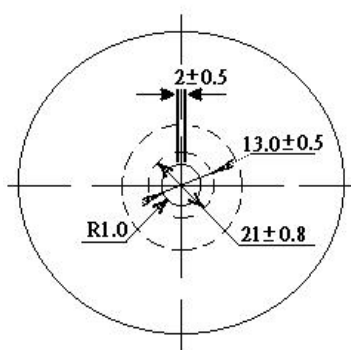

UNIT:mm

A	178 ±2.0
N	50 MIN
W1	10 ±1.5
W2	20 MAX

PACKING QTY.
3,000 PCS REEL

COMPONENT SPECIFICATION

版次：第3版

N A M E	MULTILAYER CHIP INDUCTORS	COMPOSITE SPECIFICATION		7 /
	EBLS-201212	SPEC#	EBLS2012-101K	

10-5 PEELING STRENGTH OF COVER TAPE



165°~180°

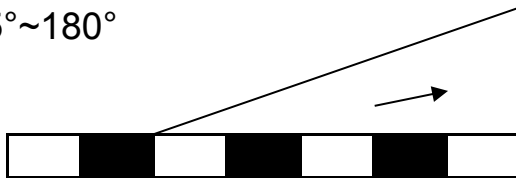

Test condition

- 1) peel angle : 165°~180° vs carrier tape
- 2) peel speed : 300mm/min

11.PACKAGING

- 1) Tape & Reel packaging in composite specification 6/8
- 2) Reel and a bag of desiccant shall be packed in Nylon or plastic bag
- 3) Maximum of 5 bags shall be packaged in a inner box
- 4) Maximum of 6 inner box shall be packaged in a outer box

12.Reel Label

Producing the goods label needs to indicate (1) Pb Free (2) RoHS Compliant

COMPONENT SPECIFICATION

版次：第3版

N A M E	MULTILAYER CHIP INDUCTORS	COMPOSITE SPECIFICATION		8 / 8
	EBLS-201212	SPEC#	EBLS2012-101K	

13. STORAGE

- 13-1 The solderability of the external electrode may be deteriorated if packages are stored where they are exposed to high humidity. Packages must be stored at 40°C or less and 70% RH or less.
- 13-2 The solderability of the external electrode may be deteriorated if packages are stored where they are exposed to dust or harmful gas (hydrogen chloride, sulfurous acid gas or hydrogen sulfide).
- 13-3 Packaging material may be deformed if packages are stored where they are exposed to heat or direct sun—light.
- 13-4 Minimum packages, such as polyvinyl heat—seal packages shall not be opened until just before they are used. If opened, use the reels as soon as possible.
- 13-5 Solderability specified in composite specification 4/8 shall be for 6 months from the date of delivery on condition that they are stored at the environment specified clause 13-1 & 13-2.
For those parts which passed more than 6 months shall be checked solderability before it is used.

14. Quality System

- ISO/TS16949
- IECQ QC 080000

X-ON Electronics

Largest Supplier of Electrical and Electronic Components

Click to view similar products for [Fixed Inductors](#) category:

Click to view products by [HYHONGYEX](#) manufacturer:

Other Similar products are found below :

[CR32NP-151KC](#) [CR32NP-180KC](#) [CR32NP-181KC](#) [CR32NP-1R5MC](#) [CR32NP-390KC](#) [CR32NP-3R9MC](#) [CR32NP-680KC](#) [CR32NP-820KC](#) [CR32NP-8R2MC](#) [CR43NP-390KC](#) [CR43NP-560KC](#) [CR43NP-680KC](#) [CR54NP-181KC](#) [CR54NP-470LC](#) [CR54NP-820KC](#) [CR54NP-8R5MC](#) [70F224AI](#) [MGDQ4-00004-P](#) [MHL1ECTTP18NJ](#) [MHQ1005P10NJ](#) [MHQ1005P1N0S](#) [MHQ1005P2N4S](#) [MHQ1005P3N6S](#) [MHQ1005P5N1S](#) [MHQ1005P8N2J](#) [PE-51506NL](#) [PE-53601NL](#) [PE-53602NL](#) [PE-53630NL](#) [PE-53824SNLT](#) [PE-92100NL](#) [PG0434.801NLT](#) [PG0936.113NLT](#) [9220-20](#) [9310-16](#) [PM06-2N7](#) [PM06-39NJ](#) [A01TK](#) [1206CS-471XJ](#) [HC2LP-R47-R](#) [HC2-R47-R](#) [HC3-2R2-R](#) [HCF1305-3R3-R](#) [1206CS-151XG](#) [RCH664NP-140L](#) [RCH664NP-4R7M](#) [RCH8011NP-221L](#) [RCP1317NP-332L](#) [RCP1317NP-391L](#) [RCR1010NP-470M](#)