

REV	ECN NO.	APPD
A	HC-17-0082	ZO

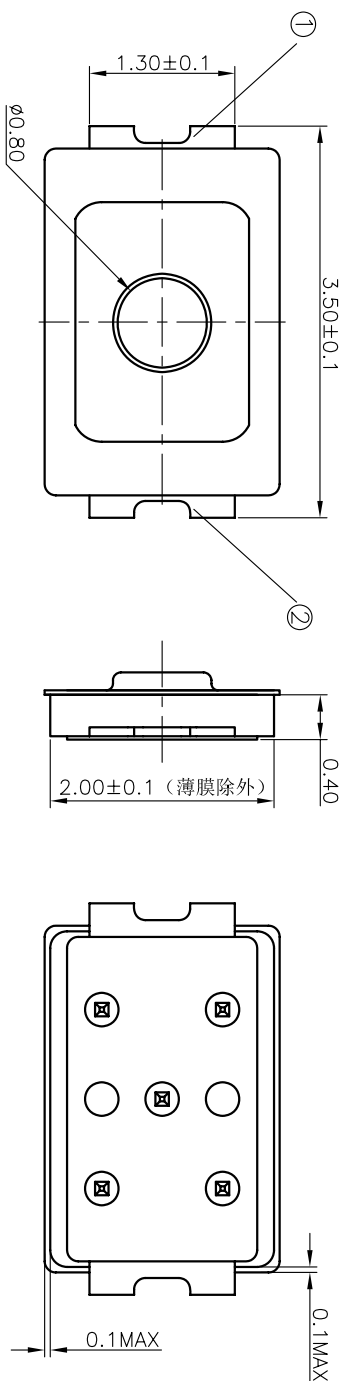

规格 Specifications

额定负荷 Rating	DC 12V/50mA
接触电阻 Contact Resistance	500mΩ max.
绝缘电阻 Insulation resistance	DC100V 60S 100MΩ min.
抗电强度 Dielectric strength	AC250V/(50~60HZ) 60S min.
操作力 Operation force	160±30gf 180±30gf 240±50gf
寿命试验 Operating Life	300,000 cycles
行程 Travels	0.13±0.05mm

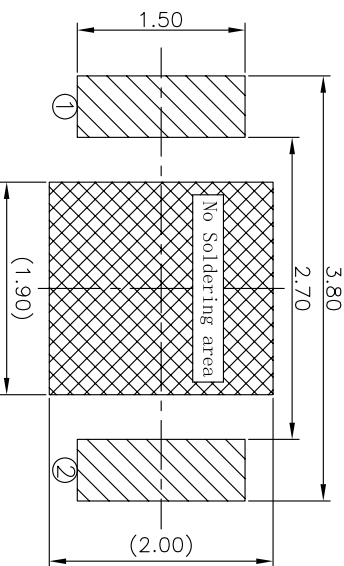
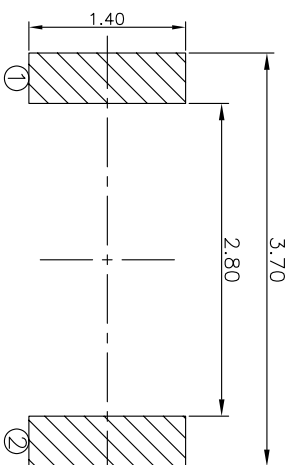
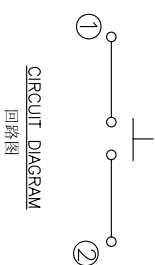
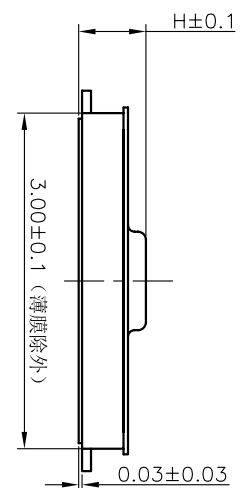

RECOMMENDED P.C.B. LAYOUT
安装尺寸图

LAND PATTERN PLAN
印刷电路板焊盘参考图

PRODUCT NO. : 1TS015A*-***-***-***-*****

轻触开关

3X2系列

外形: A=两脚
B=四脚

按点颜色:
底座颜色:
贴膜颜色:

操作力度:
160=160gf
180=180gf
200=200gf
220=220gf
240=240gf

初始颜色
则不启用

手感:
0=常规(弹片)
1=大手感(弹片)
2=小手感(弹片)
3=特殊手感(弹片)

产品高度(H):
050=0.5mm
060=0.6mm
070=0.7mm

材质:
0=初始材质
1=新增材质
依次增加

其它:
CT=编带(非编带,不启用)

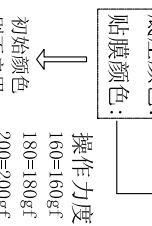

ITEM	PART NAME	QUANTITY	MATERIAL	FINISH
5	KNOB	1	POLYAMIDE	BLACK
4	FILM	1	POLYAMIDE	WHITE
3	DOVE	2	SUS301	Ag-PLATED
2	HOUSING	1	POLYAMIDE	BLACK
1	TERMINAL	1	PHOSPHOR BRONZE	Ag-PLATED

X. ± 0.2	X. ± 0.1	.XX ± 0.01	.XXX ± 0.002	UNITS	MM	NAME(INTENDED USE)	TITLE:
X. ± 0.2	X. ± 0.1	.XX ± 0.01	.XXX ± 0.002	MAT'L		3X2 SERIES TACT SWITCHES	PRODUCT DRAWING
X. ± 0.2	X. ± 0.1	.XX ± 0.01	.XXX ± 0.002	FINISH		1TS015A***-***-***-***0	
APPD: ZO 11/16/2017 CHKD: LI 11/16/2017 DR: WP.LU 11/16/2017							DWG NO.: 1TS015A

THESE DRAWINGS AND SPECIFICATIONS ARE THE PROPERTY OF HON YUAN PRECISION IND. CO., LTD. AND SHALL NOT BE REPRODUCED, COPIED OR USED IN ANY MANNER WITHOUT THE PRIOR WRITTEN CONSENT OF HON YUAN PRECISION IND. CO., LTD.

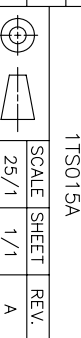

X-ON Electronics

Largest Supplier of Electrical and Electronic Components

Click to view similar products for [Tactile Switches](#) category:

Click to view products by [HYP](#) manufacturer:

Other Similar products are found below :

[5GTH92001](#) [5GTH9202242](#) [6407-250V-25273P](#) [ADTSA62NV](#) [ADTSA62RV](#) [B3F-3123](#) [1977177-8](#) [1977266-1](#) [ADTSA63NV](#)
[ADTSM21NSVTR](#) [ADTSM25RVTR](#) [ADTSM32NVTR](#) [ADTSMW64RV](#) [FSMRA4JHA04](#) [GS4.70F300QP](#) [3ESH9R](#) [KSC241J](#) [SP DELTA](#)
[LFS](#) [3FTL600RAS](#) [3FTL640RAS](#) [Y96K132V0FPLFS](#) [5GTH9658222](#) [ADTSM31NVTR](#) [EVQ-P1D05K](#) [2-1977120-7](#) [TSJW-5.2-260-TR](#)
[KMT011MNGJLHS](#) [70-201.0](#) [ADTSG648NV](#) [ADTSM62KSVTR](#) [ADTSM648NV](#) [95C06E3RAT](#) [5GTH96561](#) [3ATH9Q](#) [FSM4JSMLXTR](#)
[FSM4JSMXL](#) [FSMRA8JHA04](#) [HARS0073](#) [Y97HS12A5RAFP](#) [Y97BT23B2HAFP](#) [Y33R411N9FPLFT](#) [Y31C01402FPLFS](#)
[PTS645SK50SMTR92](#) [ADTSM32NVB](#) [KMS233GPWTLFG](#) [Y78B42324FP](#) [Y33R21116FPLFT](#) [Y31B43131FPLFG](#) [Y78B64124FP](#)
[Y71243251FP](#) [Y33R31119FPLFT](#)