

REV	ECN NO.	APPD
A	HC180073	ZO

规格 Specifications

额定负荷 Rating	DC 12V/50mA
接触电阻 Contact Resistance	500mΩ max.
绝缘电阻 Insulation resistance	DC100V 60S 100MΩ min.
抗电强度 Dielectric strength	AC250V(50-60HZ) 60S min.
操作力 Operation force	≥100±30gf ≤140±30gf
寿命试验 Operating Life	200,000 cycles
行程 Travels	0.11±0.05mm

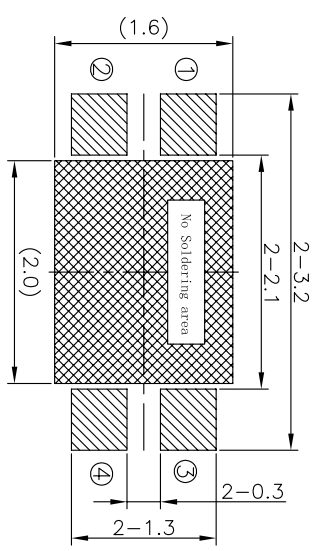
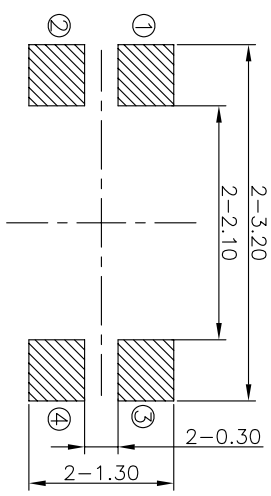
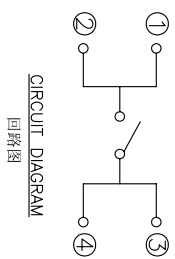
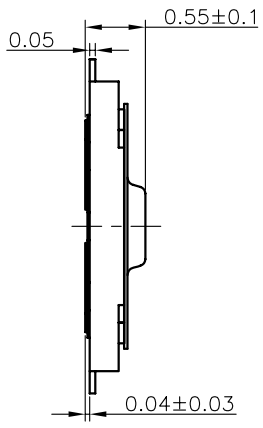
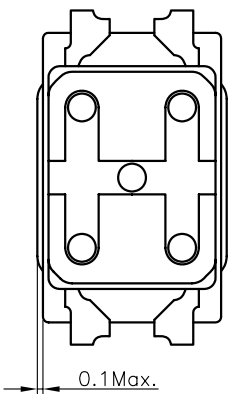
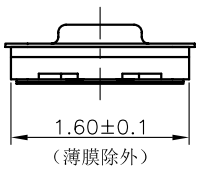
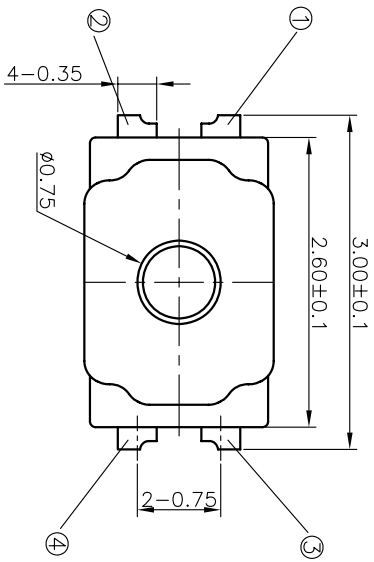

RECOMMENDED P.C.B. LAYOUT
安装尺寸图

LAND PATTERN PLAN
印刷电路板焊盘参考图

PRODUCT NO.: 1TS026A*****

- 轻触开关
- 2.6X1.6系列
- 外形: A=四脚 B=四脚无接柄
- 按点颜色:
- 底座颜色:
- 贴膜颜色:
- 操作力度: 100=100gf, 160=160gf, 180=180gf, 225=225gf, 240=240gf
- 手感: 0=常视(弹片), 1=大手感(弹片), 2=小手感(弹片), 3=特殊手感(弹片)
- 产品高度(H): 050=0.50mm, 035=0.35mm, 060=0.60mm
- 材质: 0=初始材质, 1=新理材质, 3=3个弹片依次增加
- 其它: CT=编带(非编带, 不启用)

X. ± 0.2	X' ± 3'	ITEM	PART NAME	QUANTITY	MATERIAL	FINISH
X ± 0.1	X' ± 2'	5	Knob	1	POLYAMIDE	BLACK
.XX ± 0.05	.XX' ± 1'	4	Film	1	POLYAMIDE	WHITE
.XXX ± 0.03	.XXX' ± 0.5'	3	Dome	2	STAINLESS STEEL	Ag-PLATED
		2	Housing	1	POLYAMIDE	BLACK
		1	Terminal	1	PHOSPHOR BRONZE	Ag-PLATED
NAME(INTENDED USE)		HON YUAN				
TACT SWITCHES		HON YUAN PRECISION IND. CO., LTD.				
PART NO.(INTENDED USE)		SHENZHEN, CHINA.				
1TS026A*****		TITLE: PRODUCT DRAWING				
APPD: ZO 6/05/2018		DWG NO.: 1TS026A				
CHKD: M.H.LI 6/05/2018		SCALE SHEET REV.				
DR: WP.LIU 6/05/2018		25/1 1/2 A				

THESE DRAWINGS AND SPECIFICATIONS ARE THE PROPERTY OF HON YUAN PRECISION IND. CO., LTD. AND SHALL NOT BE REPRODUCED, COPIED OR USED IN ANY MANNER WITHOUT THE WRITTEN PERMISSION OF HON YUAN PRECISION IND. CO., LTD.

X-ON Electronics

Largest Supplier of Electrical and Electronic Components

Click to view similar products for [Tactile Switches](#) category:

Click to view products by [HYP](#) manufacturer:

Other Similar products are found below :

[5GTH92001](#) [5GTH9202242](#) [6407-250V-25273P](#) [ADTSA62NV](#) [ADTSA62RV](#) [B3F-3123](#) [1977177-8](#) [1977266-1](#) [ADTSA63NV](#)
[ADTSM21NSVTR](#) [ADTSM25RVTR](#) [ADTSM32NVTR](#) [ADTSMW64RV](#) [FSMRA4JHA04](#) [GS4.70F300QP](#) [KSC241J SP DELTA LFS](#)
[3FTL600RAS](#) [3FTL640RAS](#) [Y96K132V0FPLFS](#) [5GTH9658222](#) [6407-250V-25343P](#) [ADTSM31NVTR](#) [2-1977120-7](#) [TSJW-5.2-260-TR](#)
[KMT011MNGJLHS](#) [B3WN6002S](#) [70-201.0](#) [ADTSG648NV](#) [ADTSM62KSVTR](#) [ADTSM648NV](#) [95C06E3RAT](#) [5GTH96561](#) [3ATH9Q](#)
[FSMRA8JHA04](#) [HARS0073](#) [Y33R411N9FPLFT](#) [Y31C01402FPLFS](#) [PTS645SK50SMTR92](#) [ADTSM32NVB](#) [KMS233GPWTLFG](#)
[Y78B64124FP](#) [Y96D113G0FP LFS](#) [Y33A812C5FP LFT](#) [Y56B2D120FP LFS](#) [PTS645 DVM83-BN125-2 LFS](#) [B3W 1000G](#) [KSC621G OL](#)
[LFS](#) [B3F 1002C](#) [B3F 0047H](#) [B3F 1000G](#)