

APPD	REV	ECN NO.	A
		HC-19-0220	
		ZO	

规格 Specifications

额定负荷 Rating	DC 12V/50mA
接触电阻 Contact Resistance	50mΩ max.
绝缘电阻 Insulation resistance	DC100V 60S 100MΩ min.
抗电强度 Dielectric strength	AC250V(50~60HZ) 60S min.
操作力 Operation force	≥ 100±30gf
寿命试验 Operating Life	100,000 cycles
行程 Travels	0.13±0.05mm

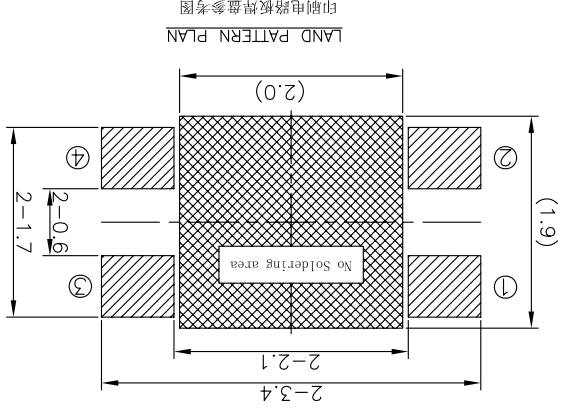
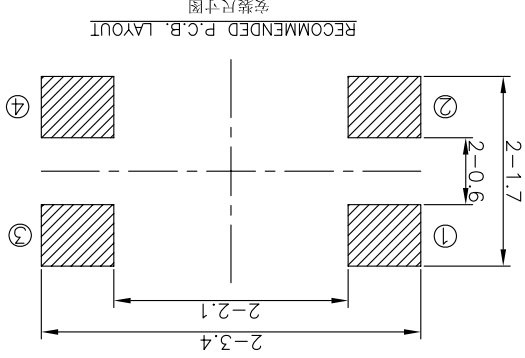
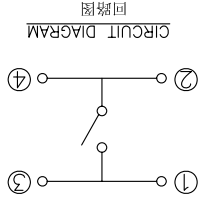
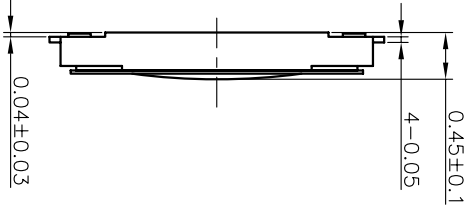
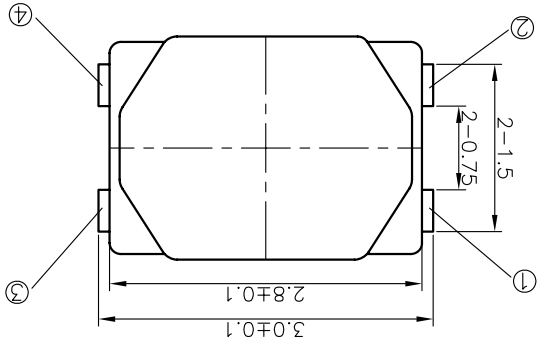
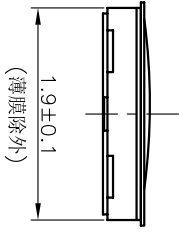
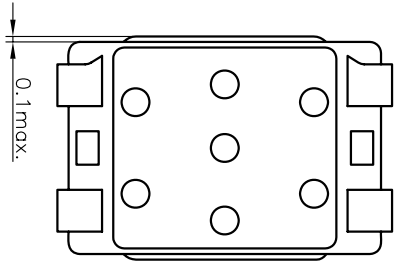

PRODUCT NO.: 1TS028B***-045**

- 轻触开关
- 2.8X1.9系列
- 外形: 0初始材质, 1新增材质, 3=3个弹片 依次增加
- 手感: 0=常规(弹片), 1=大手感(弹片), 2=小手感(弹片), 3=特殊手感(弹片)
- 操作力度: 100=100gf, 160=160gf, 225=225gf
- 贴膜颜色: 刚不启用
- 底座颜色: 刚不启用
- 按点颜色: 刚不启用
- A=四脚
- B=四脚无接柄

ITEM	PART NAME	QUANTITY	MATERIAL	FINISH
1	TERMINAL	1	PHOSPHOR BRONZE	Ag-PLATED
2	HOUSING	1	POLYAMIDE	BLACK
3	DOME	2	SUS301	Ag-PLATED
4	FILM	1	POLYAMIDE	WHITE

UNITS	MATL	FINISH	Q'TY	NAME(INTENDED USE)	HON YUAN
X. ± 0.2	X. ± 0.1	.XX ± 0.01	.XXX ± 0.002	1TS028B***-045**	2.8X1.9 SERIES TACT SWITCHES
X. ± 0.2	X. ± 0.1	.XX ± 0.01	.XXX ± 0.002	1TS028B***-045**	PART NO.(INTENDED USE)
				1TS028B***-045**	TITLE: PRODUCT DRAWNG
				1TS028B***-045**	DWG NO.: 1TS028B
				1TS028B***-045**	APD: ZO 12/06/2019
				1TS028B***-045**	CHKD: M.H.LI 12/06/2019
				1TS028B***-045**	DR:y.chen 12/06/2019

THESE DRAWINGS AND SPECIFICATIONS ARE THE PROPERTY OF HON YUAN PRECISION IND. CO., LTD. AND SHALL NOT BE REPRODUCED, COPIED OR USED IN ANY MANNER WITHOUT THE PRIOR WRITTEN CONSENT OF HON YUAN PRECISION IND. CO., LTD.

X-ON Electronics

Largest Supplier of Electrical and Electronic Components

Click to view similar products for [Tactile Switches](#) category:

Click to view products by [HYP](#) manufacturer:

Other Similar products are found below :

[KMR633NG](#) [LFG](#) [5GTH92001](#) [5GTH9202242](#) [6426-201-11343](#) [MJ1226](#) [MJTP1109B](#) [MJTP1138EAUTR](#) [MJTP1230BL](#) [MJTPSHW](#)
[GS6.90F300QP](#) [1-1977223-0](#) [1-1977120-4](#) [ADTSA62NV](#) [ADTSA62RV](#) [ADTSA63KV](#) [ADTSA644NV](#) [ADTSM24NVTR](#) [ADTSMW66NV](#)
[ADTSMW67RV](#) [ATM533VTR](#) [1571300-3](#) [B3F-3123](#) [B3F-6055A](#) [B3F-B32-01-KIT](#) [1977177-8](#) [1977266-1](#) [2-1977223-4](#) [2-1977223-7](#)
[ADTS644KV](#) [ADTSA61RV](#) [ADTSA62KV](#) [ADTSA63NV](#) [ADTSA63RV](#) [ADTSA65NV](#) [ADTSM21NSVTR](#) [ADTSM25RVTR](#)
[ADTSM31RVTR](#) [ADTSM32NVTR](#) [ADTSM61YVTR](#) [ADTSM63SVTR](#) [ADTSM644KVTR](#) [ADTSMW64RV](#) [ADTSMW69NV](#)
[FSMRA4JHA04](#) [GS4.70F300QP](#) [D38999/20JJ37SA](#) [TL1105B](#) [TL1105J](#) [ATH447K2Q](#) [ATM534VTR](#)