

GENERAL DESCRIPTION

The HP4059 series of devices are highly integrated Li-Ion and Li-Pol linear chargers targeted at small capacity battery for portable applications. It is a complete constant-current/ constant voltage linear charger. No external sense resistor is needed, and no blocking diode is required due to the internal MOSFET architecture. It can deliver up to 300mA of charge current (using a good thermal PCB layout) with a final float voltage accuracy of $\pm 1\%$. The charge voltage is fixed at 4.2V or 4.35V, and the charge current can be programmed externally with a single resistor. The charger function has high accuracy current and voltage regulation loops and charge termination.

The HP4059 automatically terminates the charge cycle when the charge current drops to 1/10 the programmed value after the final float voltage is reached.

When the input supply (wall adapter or USB supply) is removed, the HP4059 will shut off, only 40nA leakage current coming from battery at sleep mode when ambient temperature is 85°C, so it can save energy and improve standby time.

The HP4059 is available in a small package with TDFN1X1-6L. Standard product is Pb-Free and Halogen-free.

FEATURES

Charging

- 1% Charge Voltage Accuracy
- 5% Charge Current Accuracy
- Support Application for Very Low Charge Currents – 1mA to 300mA
- Support minimum 0.1mA Charge Termination Current
- 45nA Maximum Battery Output Leakage Current @ 0°C~85°C
- High Voltage Chemistry Support: up to 4.35V

Others

- Output Short-Circuit Protection
- Soft-Start Limits Inrush Current
- Charge Status Output Pin
- Automatic Recharge

APPLICATIONS

- Fitness Accessories
- Smart Watches
- Bluetooth Handsets
- Wireless Low-Power Handheld Devices

MARKING DESCRIPTION

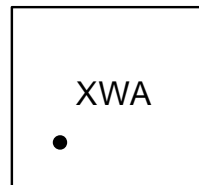

“X”: Product code, here use “X” stands for “HP4059”.

“W”: The week of manufacturing. “A” stands for week 1, “Z” stands for week 26, “a” stands for week 27, “z” stands for week 52.

“A” : Voltage code, change according to voltage version.

ORDER INFORMATION

Part NO	Package	CV Voltage	CC Current	Temperature	Tape & Reel
HP4059D6-418	TDFN1X1-6L	4.18V	Programmable Max:300mA	-40 ~ +85°C	10000/REEL
HP4059D6-42		4.2V			
HP4059D6-435		4.35V			
HP4059D6-44		4.4V			

PART NUMBER RULES

HP4059 ¹ - ²

Code	Description
¹	Package: D6: TDFN1X1-6L
²	Voltage version: 418: 4.18V 42: 4.2V 435: 4.35V

PIN ASSIGNMENT

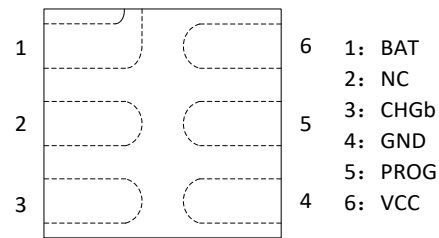

TOP VIEW

TDFN1X1-6L

PIN DESCRIPTION

Pin Number	Pin Name	I/O	Function
1	BAT	O	Charge Current Output. Provides charge current to the battery and regulates the final float voltage to 4.2V or 4.35V.
2	NC	-	-
3	CHGb	O	Open-Drain Charge Status Output. When the battery is charging, the CHGb pin is pulled low. When the charge cycle is completed or VCC is removed, the CHGb is forced high impedance.
4	GND	Ground	Ground
5	PROG	O	Charge current setting, charge current monitor. The charging current is given by $I_{BAT} = 100/R_{PROG}(A)$. Please choose 1% precision resistor for RPROG. For fixed charge current part, this pin is no bonding wire.
6	VCC	Power	Power Supply

TYPICAL APPLICATION CIRCUIT

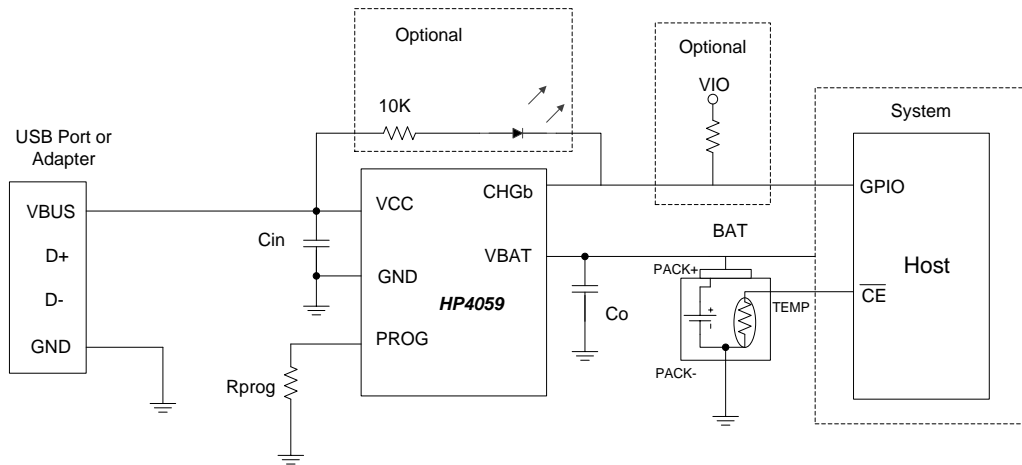

Note 1: $C_{in}=1\mu F$, $C_o=1\mu F$ are recommended, not mandatory. Good layout and pure supply voltage can omit these capacitors. R_{prog} is not needed for fixed cc current part.

ABSOLUTE MAXIMUM RATINGS (Note 2)

SYMBOL	ITEMS	VALUE	UNIT
V_{CC}	Input Voltage	-0.3~7	V
V_{PROG}	PROG Voltage	-0.3~7	V
V_{BAT}	BAT Voltage	-0.3~7	V
V_{CHGb}	CHGb Voltage	-0.3~7	V
I_{BAT}	Battery Charge Current	300	mA
P_{DMAX}	Power Dissipation	TDFN1X1-6L 0.5	W
T_J	Junction Temperature	-40~125	°C
T_{STG}	Storage Temperature	-55 to 150	°C
T_{SOLDER}	Package Lead Soldering Temperature	260°C, 10s	

Note 2: Exceed these limits to damage to the device. Exposure to absolute maximum rating conditions may affect device reliability.

RECOMMENDED OPERATING CONDITION

		MIN	NOM	MAX	UNIT
V_{CC}	Input operating voltage range	4.5	5	5.5	V
I_{BAT}	Battery charge current range	1	50	250	mA
T_J	Junction temperature	0		125	°C
R_{PROG}	CC mode charge current programming resistor	1	2	100	KΩ

SIMPLIFIED BLOCK DIAGRAM

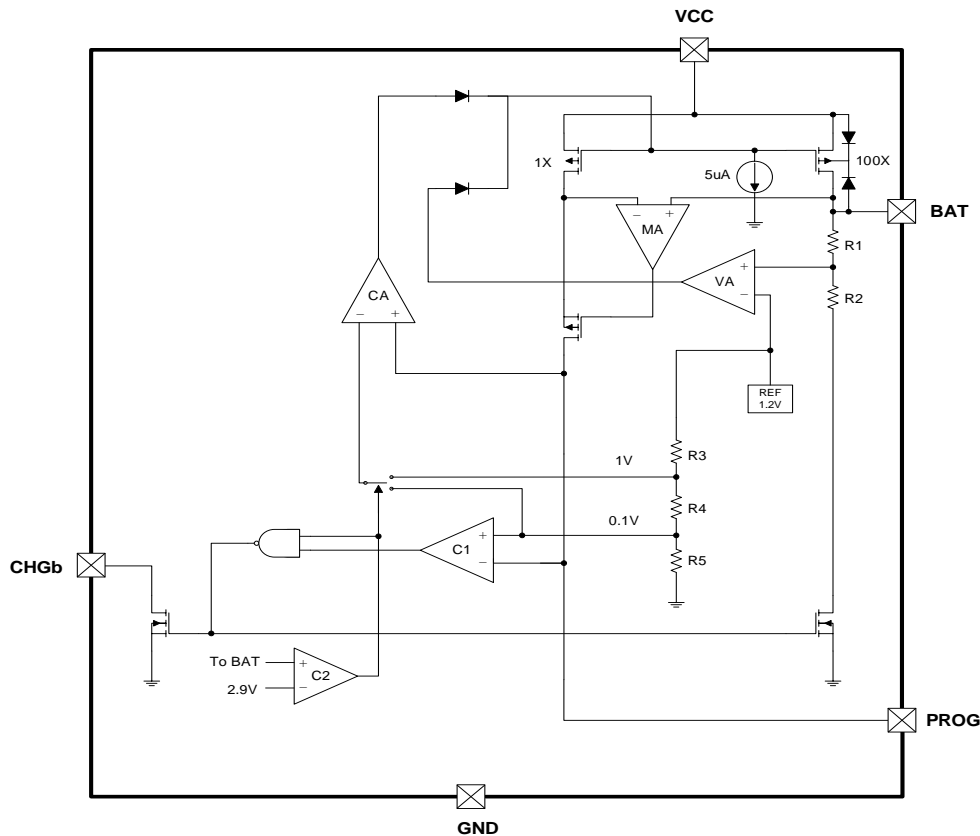

ELECTRICAL CHARACTERISTICS

The following specifications apply for $V_{CC}=5V$ $T_A=25^\circ C$, unless specified otherwise.

SYMBOL	ITEMS	CONDITIONS	MIN	TYP	MAX	UNIT
$I_{SPLYCHRG}$	Charge Mode GND Current	$R_{PROG}=1k\Omega, V_{CC}=5V$		89		μA
$I_{BATCHRG}$	Charge Mode Battery Current	$R_{PROG}=1k\Omega$	95	100	105	mA
		$R_{PROG}=2k\Omega$	47.5	50	52.5	
		$R_{PROG}=4k\Omega$	23.7	25	26.3	
$I_{SPLYSTBY}$	Standby Mode Supply Current	Charge Terminated	65	70	85	μA
$I_{BATSTBY}$	Standby Mode Battery Current	Charge Terminated		2.4		μA
$I_{SPLYASD}$	Shutdown Mode Supply Current	$V_{CC}<V_{BAT}<V_{CC}+0.3V /$ $V_{CC}<UVLO, \text{ no battery}$		27		μA
I_{BATASD}	Shutdown Mode BAT Pin Current	$V_{BAT} - V_{CC}>0.3V$		0.52		μA
$I_{BATSLEEP1}$	Sleep Mode BAT Pin Current	$V_{CC}=0$ or V_{CC} Floating $T_A=25^\circ C$		0		μA
$I_{BATSLEEP2}$	Sleep Mode BAT Pin Current	$V_{CC}=0$ or V_{CC} Floating $T_A=0^\circ C \sim 85^\circ C, \text{ Note 3}$		40	45	nA
V_{FLOAT}	Float Voltage		4.158	4.179	4.2	V
			4.158	4.2	4.242	V
			4.306	4.35	4.394	V
			4.356	4.4	4.444	V

ELECTRICAL CHARACTERISTICS (Continued)

The following specifications apply for $V_{CC}=5V$ $T_A=25^{\circ}C$, unless specified otherwise.

SYMBOL	ITEMS	CONDITIONS	MIN	TYP	MAX	UNIT
I_{TRIKL}	Trickle and Terminal Charge Current	$R_{PROG}=1k\Omega$	8	10	12	mA
		$R_{PROG}=2k\Omega$	4	5	6.5	
		$R_{PROG}=4k\Omega$	2	2.5	3.5	
V_{TRIKL}	Trickle Charge Voltage Threshold	V_{BAT} from low to high	2.8	2.9	3.0	V
$V_{TRIKL, HYS}$	Trickle Charge Voltage Hysteresis	V_{BAT} from high to low		100		mV
V_{UVLO}	UVLO Threshold	V_{CC} from Low to High	3.6	3.8	4.0	V
$V_{UVLO, HYS}$	UVLO Hysteresis	V_{CC} from high to low		270		mV
V_{ASD}	$V_{CC}-V_{BAT}$ Lockout Threshold Voltage	V_{CC} from High to Low		80		mV
		V_{CC} from Low to High		130		mV
ΔV_{RECHRG}	Auto Recharge Battery Voltage	V_{BAT} from high to low	100	150	200	mV
V_{CHGb}	CHGb Pin Output Low Voltage	$I_{CHGb}=1mA$		0.14	0.3	V
T_{SS}	Soft-Start Time	Note 3		190		us
T_{RECHRG}	Recharge Comparator Filter Time	Note 3		2		ms
T_{TERM}	Charge Terminated Filter Time	Note 3		1		ms

Note 3: Guaranteed by Design.

TYPICAL CHARACTERISTICS

Battery Current vs. Input Voltage

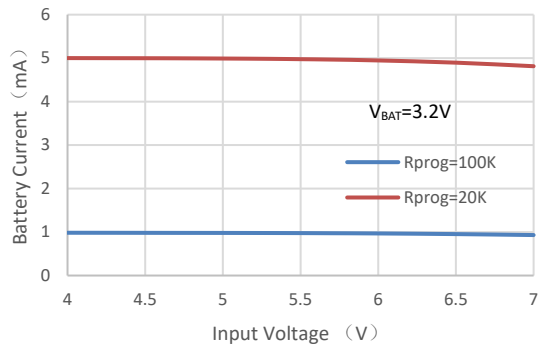

Battery Current vs. Input Voltage

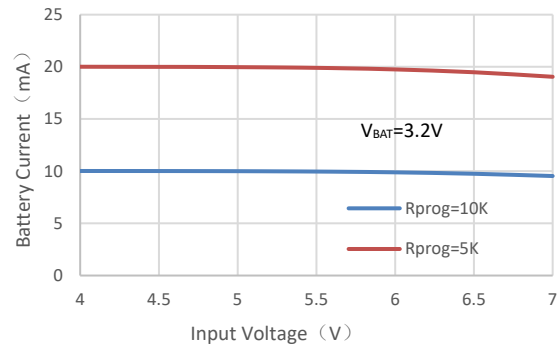

Battery Current vs. Input Voltage

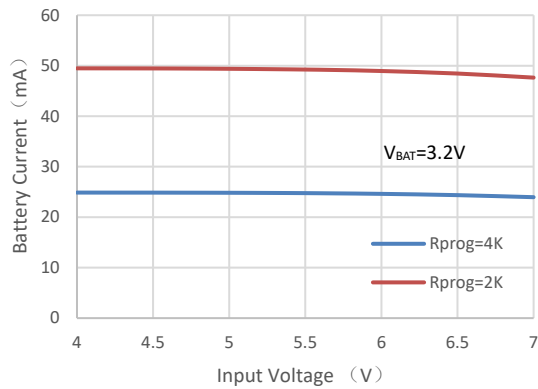

Battery Current vs. Input Voltage

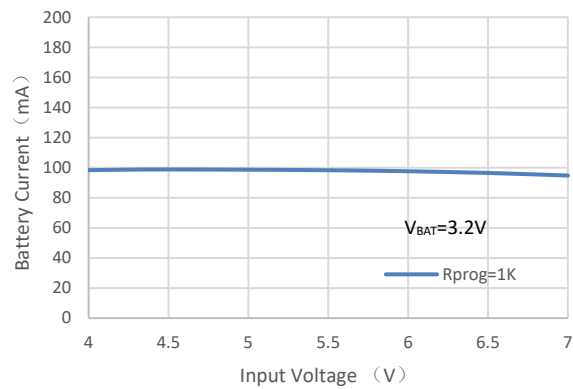

Battery Current vs. R_{PROG}

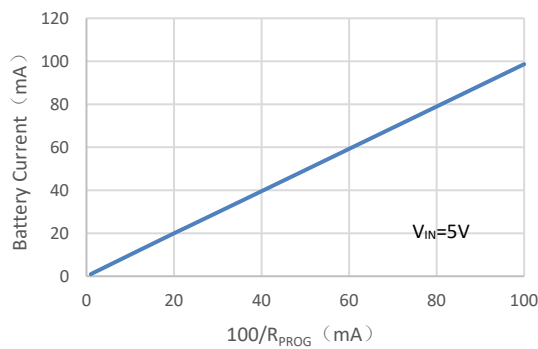

Terminal Charge Current vs. R_{PROG}

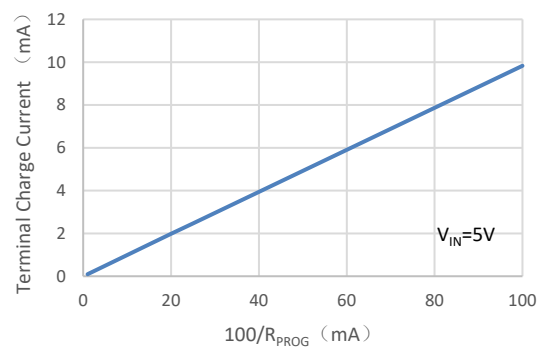

Battery Current vs. V_{PROG}

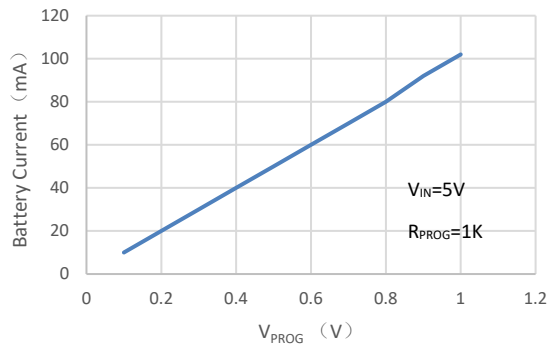

Battery Current vs. Battery Voltage

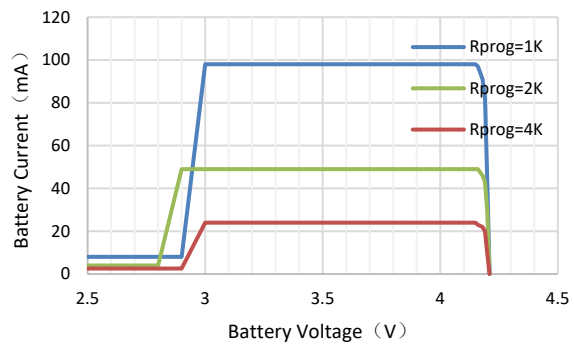

Battery Current vs. Temperature

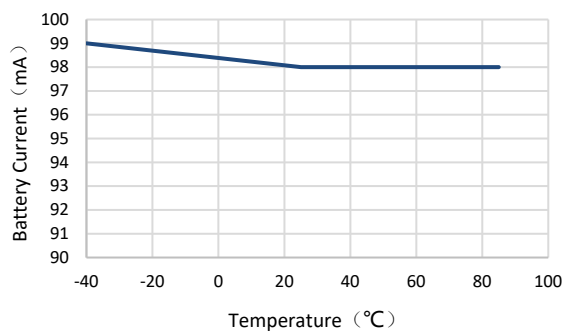

Trickle Current vs. Input Voltage

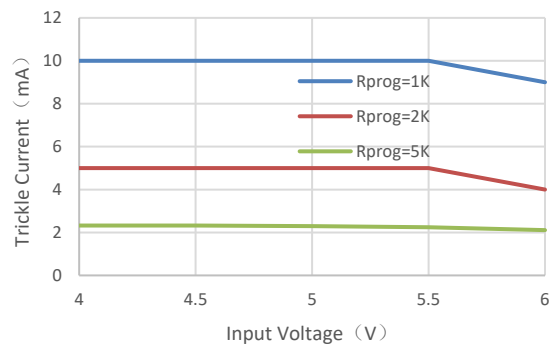

Trickle Current vs. Temperature

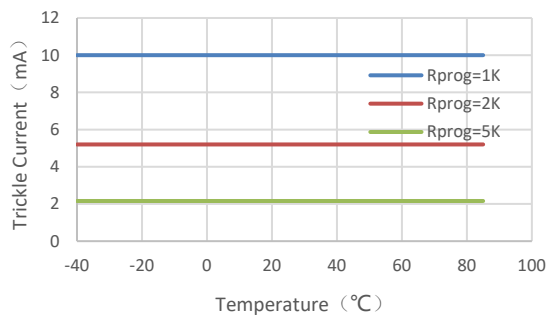

Trickle Voltage vs. Input Voltage

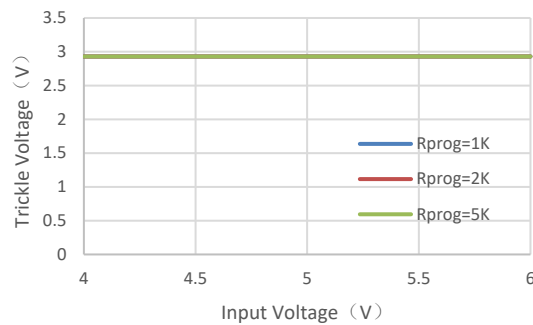

Trickle Voltage vs. Temperature

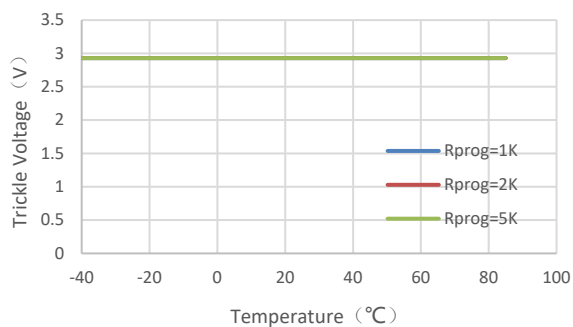

Vrecharge vs. Temperature (4.35V)

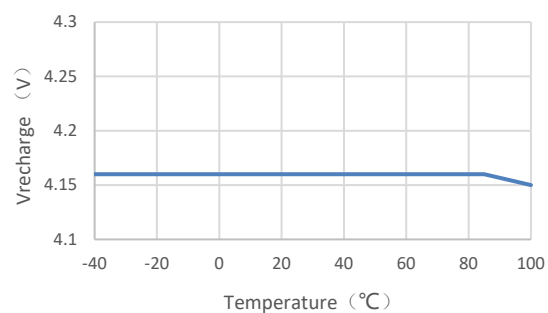

Float Voltage vs. Input Voltage (4.35V)

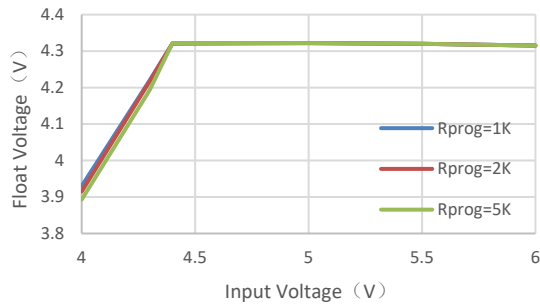

Float Voltage vs. Temperature (4.35V)

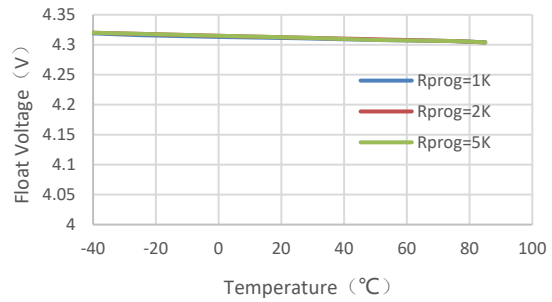

Float Voltage vs. Input Voltage (4.2V)

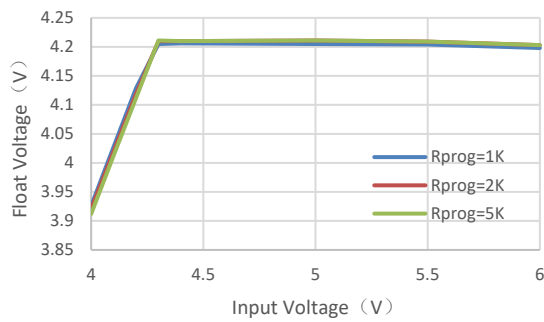

Float Voltage vs. Temperature (4.2V)

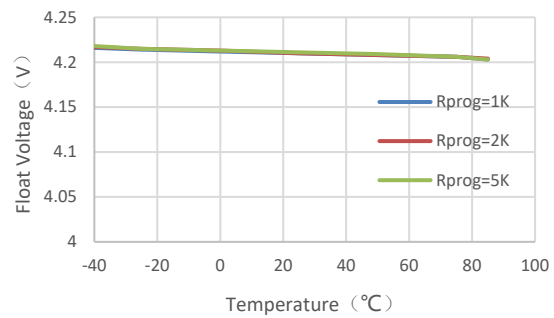

Vrecharge vs. Temperature (4.2V)

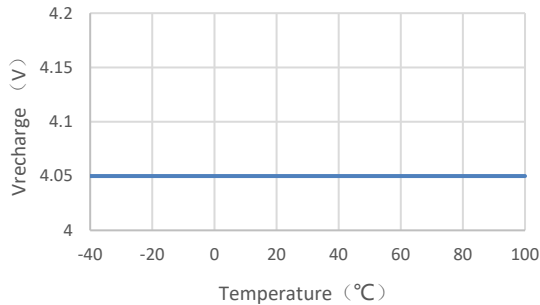

Ron vs. Temperature

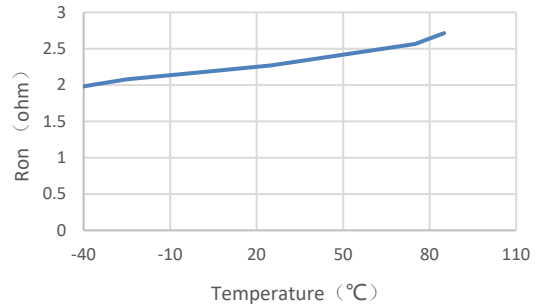

CHGb Current vs. CHGb Voltage

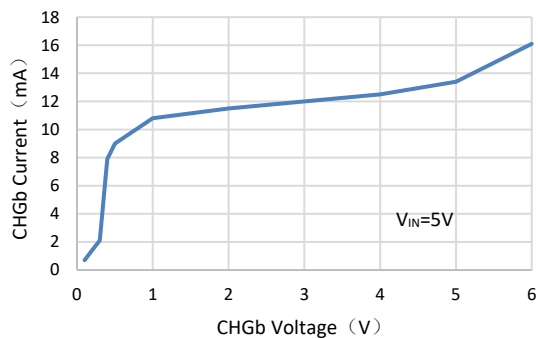

Charge Curve

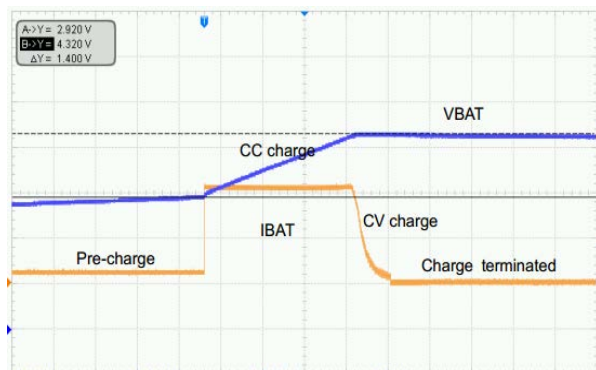

OPERATION INFORMATION

The HP4059 is a single cell Li-Ion and Li-Pol battery linear charger using a constant-current / constant-voltage algorithm. It is designed specially for small capacity battery that is used in handheld devices, such as GPS tracker, Smart wrist and U-Key. It can deliver up to 300mA of charge current (using a good thermal PCB layout) with a final float voltage accuracy of $\pm 1\%$. The HP4059 includes an internal P-channel power MOSFET and current regulation circuitry. No blocking diode or external current sense resistor is required, thus the basic charger circuit requires only two external components. Furthermore, the HP4059 is capable of operating from a USB power source.

Normal charge cycle

A charge cycle begins when the voltage at the VCC pin rises above the UVLO threshold level and a 1% program resistor is connected from the PROG pin to ground or when a battery is connected to the charger output. If the BAT pin is less than 2.9V, the charger enters trickle charge mode. In this mode, the HP4059 supplies approximately 1/10 the programmed charge current to bring the battery voltage up to a safe level for full current charging.

When the BAT pin voltage rises above 2.9V, the charger enters constant-current mode, where the programmed charge current is supplied to the battery. When the BAT pin approaches the final float voltage, the HP4059 enters constant-voltage mode and the charge current begins to decrease. The charge cycle ends when the PROG voltage is less than 100mV.

Programming charge current

The charge current is programmed using a single resistor from the PROG pin to ground. The battery charge current of constant current mode is 100 times the current out of the PROG pin. The program resistor and the charge current of constant current are calculated using the following equations:

$$I_{BAT} = 100 / R_{PROG} \text{ (A)}$$

For example, $I_{BAT}=0.1\text{A}$, $R_{PROG}=1\text{K}\Omega$, $I_{BAT}=0.02\text{A}$,

$R_{PROG}=5\text{K}\Omega$. Please choose 1% precision resistor for R_{PROG} , this will effect the accuracy of CC charge current and termination current.

Charge termination

A charge cycle is terminated when the charge current falls to 1/10 of the programmed value after the final float voltage is reached. This condition is detected by using an internal, filtered comparator to monitor the PROG pin. When the PROG pin voltage falls below 100mV for longer than T_{TERM} (typically 1ms), charging is terminated. The charge current is latched off and the HP4059 enters standby mode, where the input supply current drops to 70uA. (Note: 1/10 CC termination is disabled in trickle charging mode).

When charging, transient loads on the BAT pin can cause the PROG pin to fall below 100mV for short periods of time before the DC charge current has dropped to 1/10 of the programmed value. The 1ms filter time (T_{TERM}) on the termination comparator ensures that transient loads of this nature do not result in premature charge cycle termination. Once the average charge current drops below 1/10 of the programmed value, the HP4059 terminates the charge cycle and ceases to provide any current through the BAT pin, the chip will be put into standby mode. In this state, all loads on the BAT pin must be supplied by the battery.

The HP4059 constantly monitors the BAT pin voltage in standby mode. If this voltage drops below the $V_{float}-0.15\text{V}$ (typically) recharge threshold (V_{RECHRG}), another charge cycle begins and current is once again supplied to the battery. The state diagram of a typical charge cycle is as below:

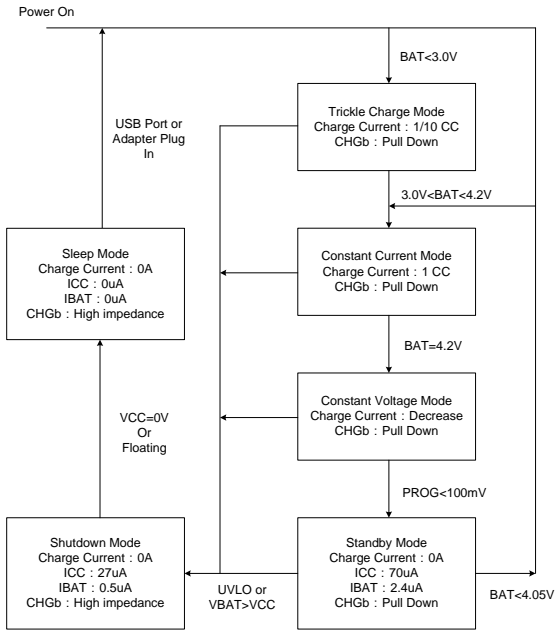

Charge status indicator (CHGb)

The charge status output indicator is an open drain circuit. The indicator has two different states: pull-down (~16mA), and high impedance. The pull-down state indicates that the HP4059 is in a charge cycle. High impedance indicates that the charge cycle is complete. The CHGb also can be used to detect the charge states by a microprocessor with a pull-up resistor.

Shutdown mode

The HP4059 will be put into shutdown mode when the battery voltage is higher than the V_{CC} voltage or $V_{CC}-V_{BAT}$ is less than V_{ASD} . This reduces the battery drain current to less than 0.5uA and the supply current to less than 27uA. A new charge cycle can be initiated when the $V_{CC}-V_{BAT}$ is high than V_{ASD} .

The HP4059 also be put into shutdown mode when V_{CC} voltage down to UVLO threshold. In this state, the CHGb pin is high impedance state. The CHGb pin is also in a high impedance state if the charge cycle is completed.

Automatic recharge

Once the charge cycle is terminated, the HP4059 continuously monitors the voltage on the BAT pin using a comparator with a 2ms filter time (T_{RECHRG}). A charge cycle restarts when the battery voltage falls below delta V_{RECHRG} (which corresponds to approximately 80% to 90% battery capacity). This ensures that the battery is kept at or near a fully charged condition and eliminates the need for periodic charge cycle initiations. CHGb output enters a pull-down state during recharge cycles.

APPLICATION INFORMATIONS

Stability considerations

The constant-voltage mode feedback loop is stable without an output capacitor provided a battery is connected to the charge output. With no battery present, an output capacitor is recommended to reduce ripple voltage.

In constant-current mode, the PROG pin is in the feedback loop, not the battery. The constant-current mode stability is affected by the impedance at the PROG pin. With no additional capacitance on the PROG pin, the charger is stable with program resistor values as high as 100KΩ. However, additional capacitance on this node reduces the maximum allowed program resistor thus it should be avoided.

Power dissipation

HP4059 has low temperature coefficient, at higher temperatures, the charging current will decrease slightly. To -40 °C ~125 °C temperature range the change of the charging current is very small. Nearly all of this power dissipation is generated by the internal MOSFET. This is calculated to be approximately:

$$P_D = (V_{CC} - V_{BAT}) * I_{BAT}$$

Maximum allowable power dissipation limited by the packaging format and cooling conditions in actual applications. For TDFN1X1-6L package, P_D is not

allowed to exceed 0.3W. For example, the worse case application of HP4059 is $V_{CC}=5.5V$, $V_{BAT}=3V$, $I_{BAT}=0.1A$, so $P_D=0.25W$, it is safe. At charge cycle, the battery voltage is rising gradually, so the power dissipation is reduce accordingly. The power dissipation turn into heat, please taken into consideration when design system.

VCC bypass capacitor

Many types of capacitors can be used for input bypass, however, caution must be exercised when using multilayer ceramic capacitors. Because of the self-resonant and high Q characteristics of some types of ceramic capacitors, a 10uF/16V ceramic capacitor is recommended for this bypass capacitor. Due to a high voltage transient will be generated under some start-up conditions, such as connecting the charger input to a live power source.

Charge current soft-start

The HP4059 includes a soft-start circuit to minimize the inrush current at the start of a charge cycle. When a charge cycle is initiated, the charge current ramps from zero to the full-scale current over a period of approximately 190us. This has the effect of minimizing the transient current load on the power supply during start-up.

PACKAGE OUTLINE

Package	TDFN1X1-6L	Devices per reel	10000Pcs	Unit	mm		
Package Dimension:							
<p>TOP VIEW</p>		<p>BOTTOM VIEW</p>					
<p>SIDE VIEW</p>							
Symbol	Millimeter			Symbol	Inches		
	MIN	NOM	MAX		MIN	NOM	MAX
A	0.320	-	0.400	A	0.013	-	0.016
A1	0.000	0.020	0.050	A1	0.000	0.001	0.002
A3	0.100REF			A3	0.004REF		
D	0.950	1.000	1.050	D	0.037	0.039	0.041
E	0.950	1.000	1.050	E	0.037	0.039	0.041
K	0.150MIN			K	0.006MIN		
b	0.120	0.175	0.230	b	0.005	0.007	0.009
e	0.350TYP			e	0.014TYP		
L	0.350	0.400	0.450	L	0.014	0.016	0.018
L1	0.350	0.400	0.450	L1	0.014	0.016	0.018

REVISION HISTORY

Version No.	Date	Description
Preliminary	2017-06-05	- Initial preliminary release
V 0.1	2017-06-15	- Update typical application circuit - Update Package outline
V 0.2	2017-06-26	- Update Font - Update Ordering information - Add part number rules - Update pin assignment pictures - Update Package outline
V 0.3	2017-09-14	- Update Package outline - Update pin assignment pictures - Update PROG related function
V 0.4	2018-02-12	- Update marking description
V 0.5	2019-01-18	- Update maximum charge current
V1.0	2020-04-13	- Update marking description - Add HP4059D6-418/44

X-ON Electronics

Largest Supplier of Electrical and Electronic Components

Click to view similar products for [Battery Management](#) category:

Click to view products by [Hypower Microelectronics](#) manufacturer:

Other Similar products are found below :

[MP2602DQ-LF-P](#) [MP26053DQ-LF-Z](#) [MP2611GL-P](#) [NCP347MTAHTBG](#) [LM3658SD-AEV/NOPB](#) [MP2607DL-LF-P](#) [MP26121DQ-LF-P](#)
[MP26123DR-LF-P](#) [MP2633GR-P](#) [MP2637GR-P](#) [BQ24212EVM-678](#) [NCP1855FCCT1G](#) [MP2636GR-P](#) [FAN54063UCX](#)
[MAX14680EWC+T](#) [MAX14634EWC+T](#) [DS2745U+T&R](#) [MAX14578EETE+T](#) [DS2781EVKIT+](#) [DS2781E+T&R](#) [MP2605DQ-LF-P](#)
[DS2710G+T&R](#) [MAX17040G+T](#) [MAX14525ETA+T](#) [MP2615GQ-P](#) [MAX14578EEWC+T](#) [LC05132C01NMTTGTG](#) [MAX8971EWP+T](#)
[MAX14630EZK+T](#) [MAX1873TEEE+T](#) [PSC5415A](#) [AUR9811DGD](#) [SN2040DSQR](#) [DS2715BZ+T&R](#) [MAX1508ZETA+T](#)
[MAX14921ECS+T](#) [MAX77301EWA+T](#) [BD8668GW-E2](#) [MAX16024PTBS+T](#) [DS2715Z+T&R](#) [MAX16024LTBZ18+T](#) [DS2782E+T&R](#)
[DS2782G+T&R](#) [MAX1908ETI+T](#) [ISL95522IRZ](#) [ISL95522HRZ](#) [ARD00558](#) [NCP4371AAEDR2G](#) [BD8665GW-E2](#) [MAX8934EETI+T](#)