

GENERAL DESCRIPTION

The HP6013 is a high accuracy, low noise, high speed, low dropout CMOS Linear regulator with high ripple rejection and fast discharge function. The device offers a new level of cost effective performance in cellular phones, surveillance system, Bluetooth, wireless and other portable electronic devices.

HP6013 can provide product selections of output value in the range of 1.0V~3.6V by every 0.1V step.

The current limiter's fold-back circuit also operates as a short circuit protection and an output current limiter at the output pin.

The HP6013 regulators are available in standard SOT23-5L and DFN1x1-4L packages. Standard products are Pb-free and Halogen-free.

FEATURES

- Input voltage: 2.5V~6.5V
- Output range: 1.0V~3.6V (customized by every 0.1V step)
- Maximum output current: 400mA @ $V_{IN}-V_{OUT}=0.5V$
- PSRR: 75dB @1KHz
- Dropout voltage: 220mV @ $I_{OUT}=200mA$
- Quiescent current : 35 μ A Typ.
- Shut-down current: < 1 μ A
- Recommend capacitor: 1 μ F
- Ultra-low output noise: 20 μ V_{RMS}

APPLICATIONS

- Digital cameras
- Cellphones
- Bluetooth and wireless handsets
- Other portable electronic devices

TYPICAL APPLICATION CIRCUIT

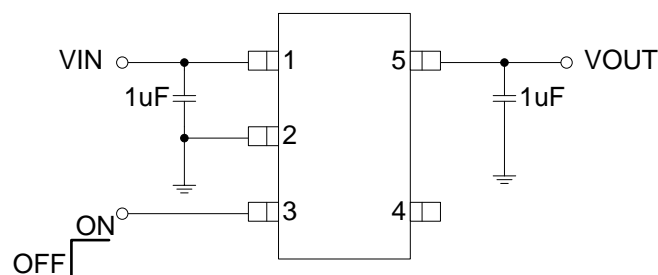

PIN ASSIGNMENT



SOT23-5L

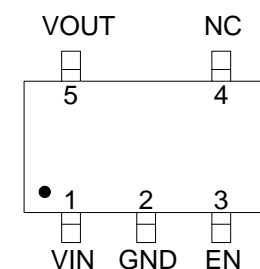

SOT23-5L (Top View)



DFN1x1-4L

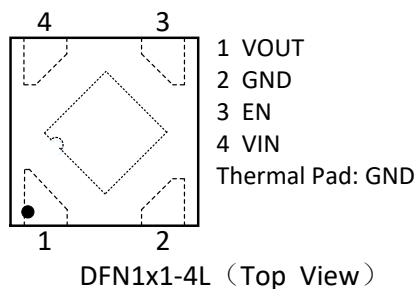

ORDER INFORMATION

PART NO	PACAKGE	VOUT DISCHARGE	TEMPERATURE	TAPE & REEL
HP6013AS5-XX ^{Note}	SOT23-5L	Yes	-40 ~ +85°C	3000/REEL
HP6013BS5-XX ^{Note}	SOT23-5L	No	-40 ~ +85°C	3000/REEL
HP6013AD4-XX ^{Note}	DFN1x1-4L	Yes	-40 ~ +85°C	10000/REEL
HP6013BD4-XX ^{Note}	DFN1x1-4L	No	-40 ~ +85°C	10000/REEL

Note: XX indicates 1.0V~3.6V by 0.1V step. For example, 28 means product outputs 2.8V

PART NUMBER RULES

HP6013 [1]-[2]-[3]

Code	Description
[1]	Vout discharge A: Yes; B: No
[2]	Package: S5: SOT23-5L D4: DFN1x1-4L
[3]	Voltage version: XX: 1.0V~3.6V by 0.1V step Example: 28: 2.8V

MARKING DESCRIPTION:

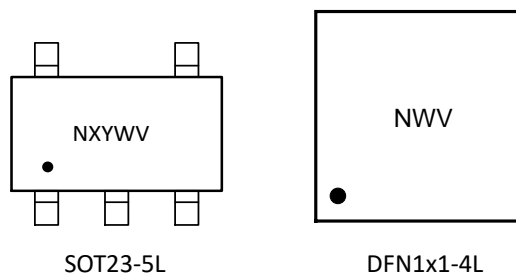

“N”: Product code, here use “L” stand for “HP6013”

“X”: Internal Control Code

“Y”: Internal Control Code

“W”: The week of manufacturing. “A” stands for week 1, “Z” stands for week 26, “a” stands for week 27, “z” stands for week 52.

“V”: Output voltage code.

PIN DESCRIPTION

PIN NO	SYMBOL	I/O	DESCRIPTION
SOT23-5L			
1	VIN	Power	Input
2	GND	Ground	Ground
3	EN	I	Enable (active high, do not float)
4	NC	/	Not connected
5	VOUT	O	Output

PIN NO	SYMBOL	I/O	DESCRIPTION
DFN1x1-4L			
1	VOUT	O	Output
2	GND	Ground	Ground
3	EN	I	Enable (active high, do not float)
4	VIN	Power	Input

TYPICAL OUTPUT VOLTAGE CODE TABLE

V _{out}	CODE	V _{out}	CODE
1.0V	A	1.2V	B
1.5V	C	1.8V	D
2.8V	M	3.0V	G
3.3V	H	3.6V	I

ABSOLUTE MAXIMUM RATINGS (Note)

SYMBOL	ITEMS	VALUE	UNIT
V _{IN}	Input Voltage	-0.3~8	V
I _{OUT}	Output Current	550	mA
P _{DMAX}	Power Dissipation	SOT23-5L	0.3
		DFN1x1-4L	0.6
T _J	Junction Temperature	-40~125	°C
T _A	Ambient Temperature	-40~85	°C
T _{STG}	Storage Temperature	-55 to 150	°C
T _{SOLDER}	Package Lead Soldering Temperature	260°C, 10s	

Note: Exceed these limits to damage to the device. Exposure to absolute maximum rating conditions may affect device reliability.

RECOMMENDED OPERATING RANGE

SYMBOL	ITEMS	VALUE	UNIT
V_{IN}	Supply Voltage	2.5 to 6.5	V
I_{OUT}	Output Current	<300	mA
T_{OPT}	Operating Temperature	-40 to +85	°C

ELECTRICAL CHARACTERISTICS

The following specifications apply for $V_{OUT}=2.8V$ $T_A=25^{\circ}C$, unless specified otherwise.

SYMBOL	ITEMS	CONDITIONS	MIN	TYP	MAX	UNIT
V_{IN}	Input Voltage				6.5	V
V_{OUT}	Output Range	$V_{OUT} < 2V$, $V_{IN}=2.7V$, $I_{OUT}=1mA$	-3	V_{OUT}	3	%
		$V_{OUT} \geq 2V$, $I_{OUT}=1mA$	-2	V_{OUT}	2	
I_Q	Quiescent Current	$V_{OUT}=2.8V$, $I_{OUT}=0$		35		μA
I_{LIMIT}	Current Limit	$V_{IN}=V_{EN}=4.5V$		500		mA
V_{DROP}	Dropout Voltage	$V_{OUT}=2.8V$, $I_{OUT}=200mA$		220	250	mV
		$V_{OUT}=2.8V$, $I_{OUT}=300mA$		320	350	
ΔV_{LINE}	Line Regulation	$V_{IN}=2.7\sim 5.5V$, $I_{OUT}=1mA$		0.01	0.15	%/V
ΔV_{LOAD}	Load Regulation	$V_{OUT}=2.8V$, $I_{OUT}=1\sim 300mA$		40	70	mV
I_{SHORT}	Short Current	$V_{EN}=V_{IN}$, V_{OUT} Short to GND with 1Ω		80		mA
I_{SHDN}	Shut-down Current	$V_{EN}=0V$			1	μA
PSRR	Power Supply Rejection Rate	$V_{IN}=5V_{DC}+0.5V_{P-P}$ $F=1KHz$, $I_{OUT}=10mA$		75		dB
		$V_{IN}=5V_{DC}+0.5V_{P-P}$ $F=1MHz$, $I_{OUT}=10mA$		55		
V_{ENH}	EN logic high voltage	$V_{IN}=5.5V$, $I_{OUT}=1mA$	1.2		V_{IN}	V
V_{ENL}	EN logic low voltage	$V_{IN}=5.5V$, $V_{OUT}=0V$			0.4	V
I_{EN}	EN Input Current	$V_{EN}=0$ to 5.5V			1.0	μA
e_{NO}	Output Noise Voltage	10Hz to 100KHz, $C_{OUT}=1\mu F$		20		μV_{RMS}

SIMPLIFIED BLOCK DIAGRAM

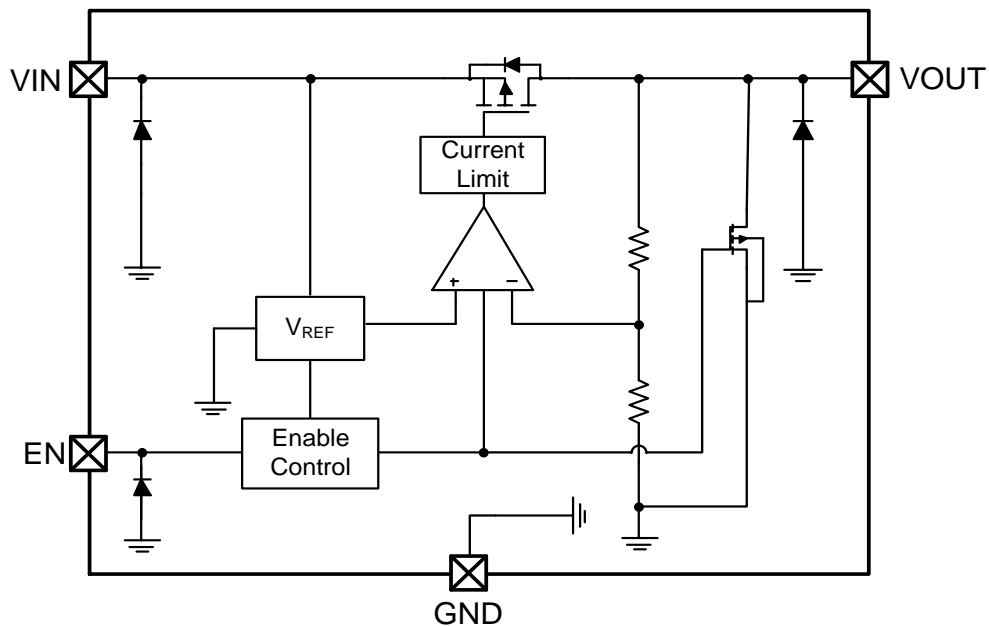

TYPICAL PERFORMANCE CHARACTERISTICS

$C_{IN}=1\mu F$, $C_{OUT}=1\mu F$, $V_{IN}=4.5V$, $V_{OUT}=2.8V$ $T_A=25^\circ C$, unless specified otherwise. (Package:SOT23-5L)

IQ vs. Input Voltage

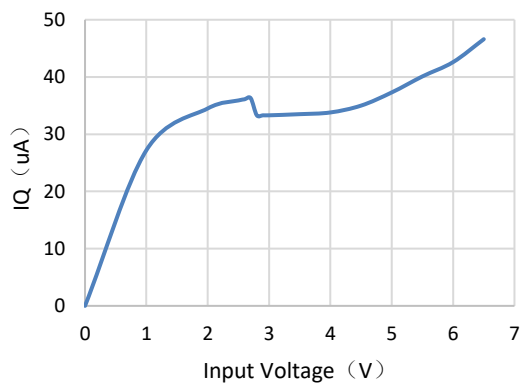

IQ vs. Temperature

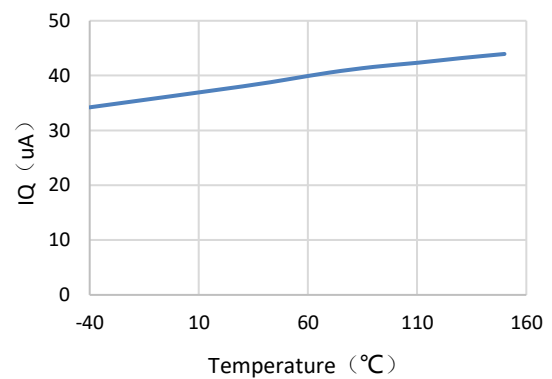

Output Voltage vs. Input Voltage

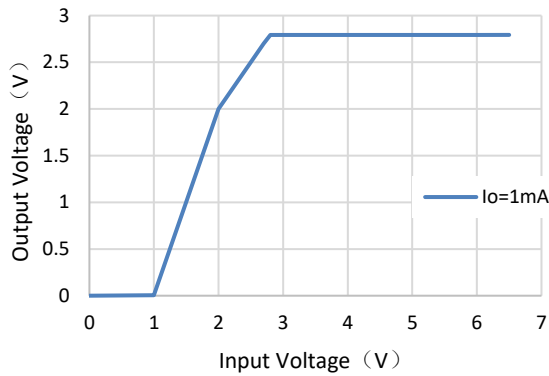

Output Voltage vs. Temperature

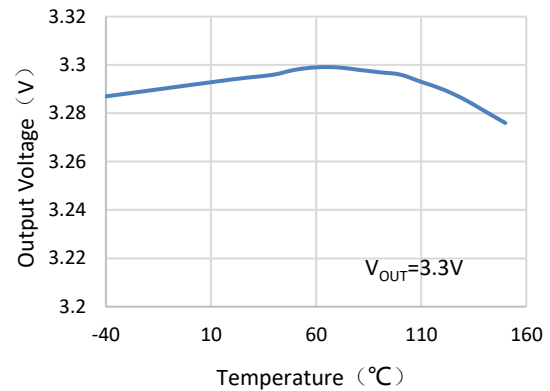

Output Voltage vs. Output Current

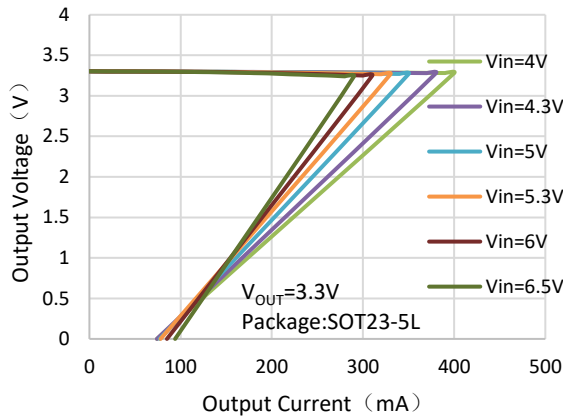

Output Voltage vs. Output Current

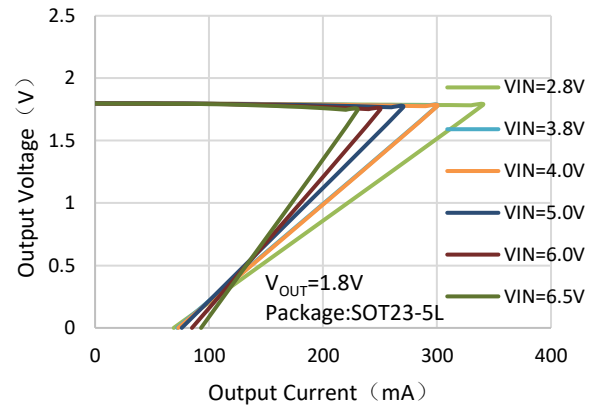

Output Voltage vs. Output Current

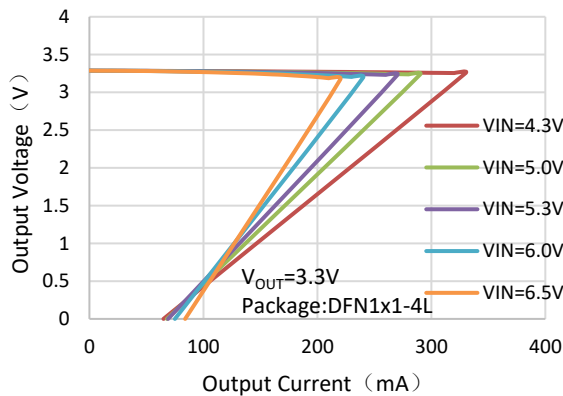

Output Voltage vs. Output Current

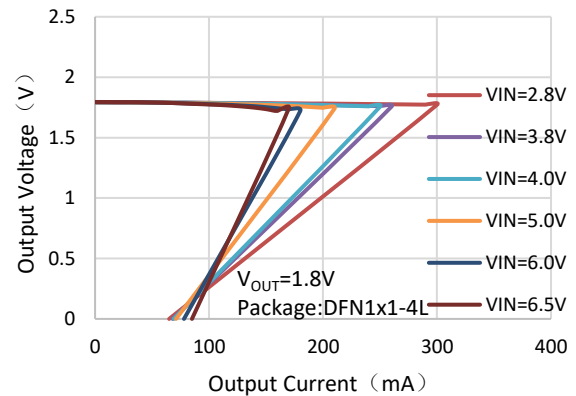

Current Limit vs. Input Voltage

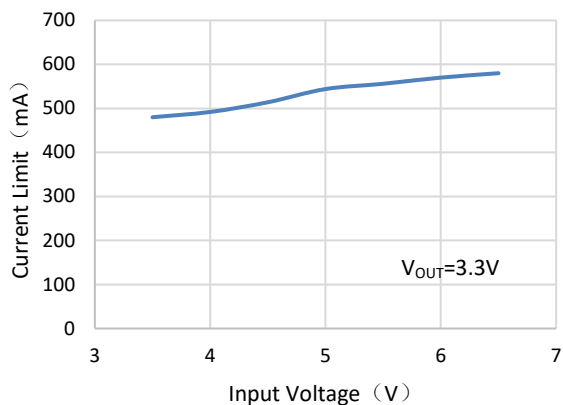

Current Limit vs. Input Voltage

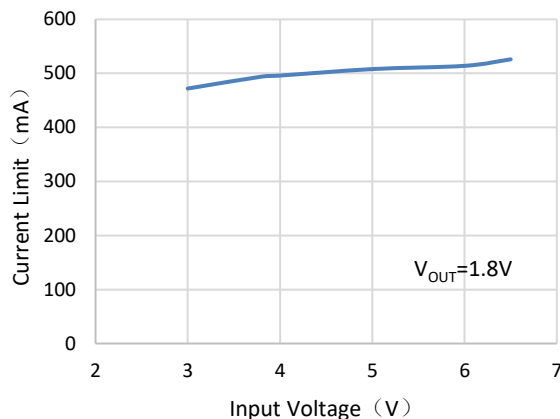

Dropout Voltage vs. Output Current

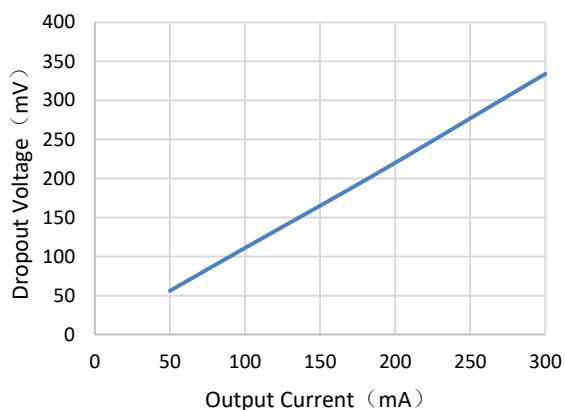

PSRR vs. Frequency

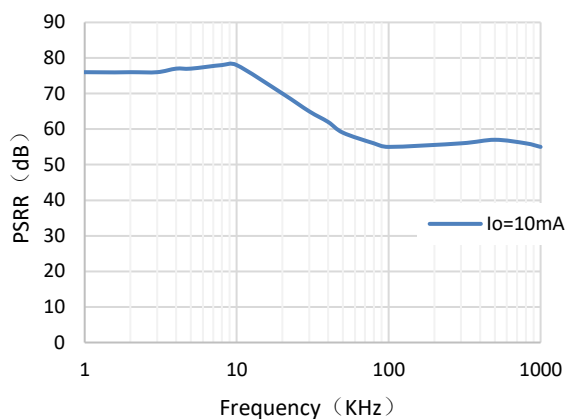

EN ON / OFF

V_{EN}=0V to 4.5V

I_{OUT}=10mA



V_{EN}=4.5V to 0V

I_{OUT}=10mA



Power ON / OFF

$V_{IN}=0V$ to $4.5V$ $I_{OUT}=10mA$

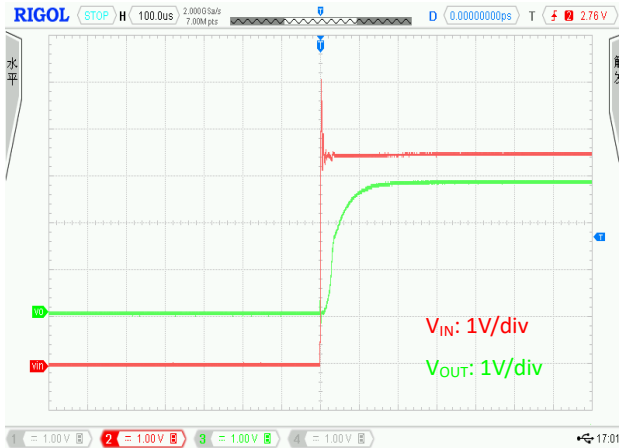

$V_{IN}=4.5V$ to $0V$ $I_{OUT}=10mA$



Line Transient

$V_{IN}=4V$ to $5V$ $I_{OUT}=10mA$

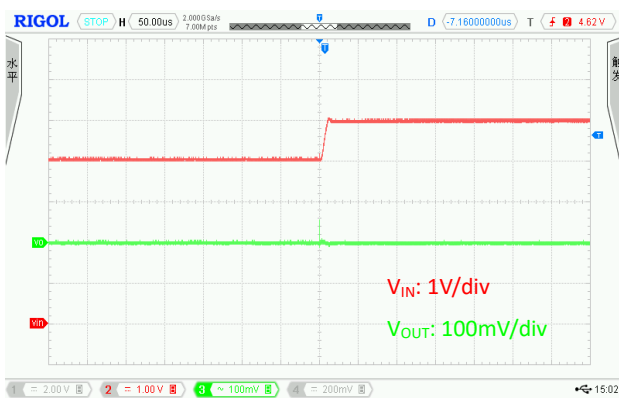

$V_{IN}=5V$ to $4V$ $I_{OUT}=10mA$



Load Transient

$V_{IN}=4.5V$ $I_{OUT}=1mA$ to $60mA$

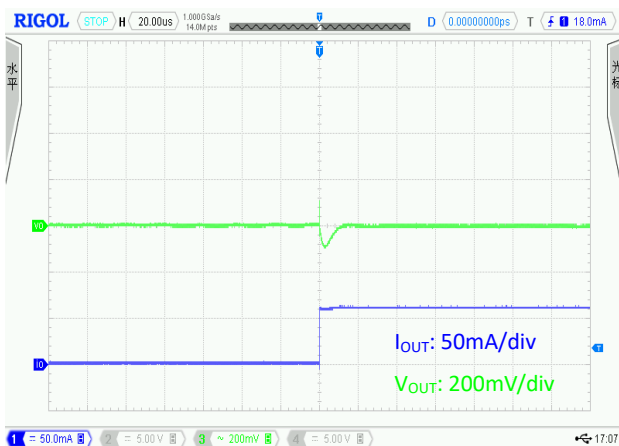

$V_{IN}=4.5V$ $I_{OUT}=60mA$ to $1mA$



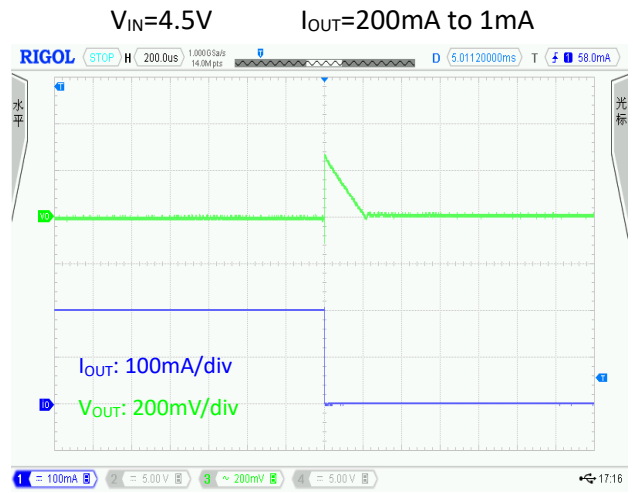
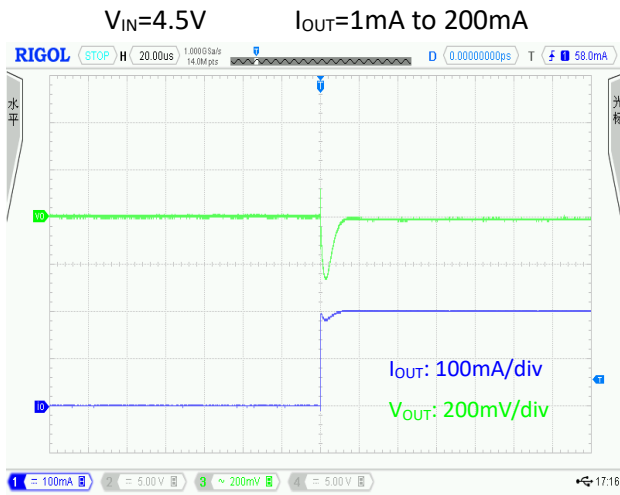

PACKAGE OUTLINE

Package	SOT23-5L	Devices per reel	3000Pcs	Unit	mm
Package Dimension:					
Symbol	Dimensions In Millimeters		Dimensions In Inches		
	Min	Max	Min	Max	
A	1.050	1.250	0.041	0.049	
A1	0.000	0.100	0.000	0.004	
A2	1.050	1.150	0.041	0.045	
b	0.300	0.500	0.012	0.020	
c	0.100	0.200	0.004	0.008	
D	2.820	3.020	0.111	0.119	
E	1.500	1.700	0.059	0.067	
E1	2.650	2.950	0.104	0.116	
e	0.950(BSC)		0.037(BSC)		
e1	1.800	2.000	0.071	0.079	
L	0.300	0.600	0.012	0.024	
θ	0°C	8°C	0°C	8°C	

PACKAGE OUTLINE

Package	DFN1x1-4L	Devices per reel	10000Pcs	Unit	mm
Package Dimension:					
<p style="text-align: center;">TOP VIEW [顶视图]</p>		<p style="text-align: center;">SIDE VIEW 侧视图</p>			
<p style="text-align: center;">BOTTOM VIEW 背视图</p>					

REVISION HISTORY

Version No.	Date	Description
Preliminary	2018-05-03	- Initial preliminary release
V0.1	2018-05-23	- Update electrical characteristics - Update typical performance characteristics
V0.2	2018-09-10	- Update current limit - Update temperature coefficient
V0.3	2018-12-04	- Add DFN1x1-4L package
V0.4	2019-02-25	- Update typical performance characteristics
V 1.0	2019-12-02	- Update marking description

X-ON Electronics

Largest Supplier of Electrical and Electronic Components

Click to view similar products for [hypower microelectronics manufacturer](#):

Other Similar products are found below :

[HP6215T3-50](#) [HP4054S5-435](#) [HP6003S3-33](#) [HP6215T3-30](#) [HP6513T3B-30](#) [HP6215S3-50](#) [HP6513S3-33](#) [HP4056E8-435](#) [HP6513T3B-50](#)
[HP6017S5-33](#) [HP6003S3-18](#) [PS9113](#) [HP6013AS5-30](#) [HP6513T3B-36](#) [HP6013AS5-29](#) [HP6013AS5-36](#) [HP4059D6-42](#) [HP6013AS5-15](#)
[HP6013AS5-28](#) [HP6013AS5-18](#) [HP6013AS5-25](#) [HP6513S5B-50](#) [HP6215S3-28](#) [HP4058S5-42](#) [HP4054S5-42](#) [HP6003S3-30](#) [HP6013AS5-12](#)
[HP6013AS5-27](#) [HP6014AS5-18](#) [HP6017S5-30](#) [HP6014AS5-30](#) [HP6003S-15](#) [HP6003S3-12](#) [HP6003S3-28](#) [HP6013AS5-10](#) [HP6513S5A-50](#)
[HP6013AS5-26](#) [HP6014AS5-28](#) [HP6513S5B-33](#) [HP4555D8-42](#) [HP4056E8-42](#) [HP4554D8-435](#) [HP4555D8-435](#) [HP4554D8-44](#) [HP6013AD4-18](#) [HP4059D6-44](#) [HP6013AD4-25](#) [HP4059D6-435](#)