

GENERAL DESCRIPTION

The HP6215 series is a set of three-terminal, low power, high voltage regulators implemented in CMOS technology. The series features extremely low quiescent current which is typically 2.0μA. They allow input voltages as high as 16V. The device provides large current with a significantly small dropout voltage.

The HP6215 consists of a high-precision voltage reference, an error correction circuit, an over temperature protection circuit, and a current limited output driver. They are available with several fixed output voltages ranging from 2.5V to 5.0V. CMOS technology ensures low dropout voltage and low current consumption.

The HP6215 regulators are available in standard SOT89-3L and SOT23-3L packages. Standard products are Pb-free and Halogen-free.

FEATURES

- Input voltage: 3V~16V
- Output range: 2.5V~5.0V
- Output current: 500mA (Within Max Power Dissipation)
- Dropout voltage: 200mV @ $V_{OUT}=3.3V$, $I_{OUT}=100mA$
- Quiescent current: 2μA Typ.
- Good line regulation: 0.01%/V
- Good load regulation: 5mV@1mA ≤ I_o ≤ 50mA
- Low temperature coefficient: 0.07mV/°C
- Soft start

APPLICATIONS

- Battery powered equipment
- Voltage regulator for microprocessor
- Voltage regulator for LAN cards
- Wireless communication equipment
- Audio/Video equipment

TYPICAL APPLICATION CIRCUIT

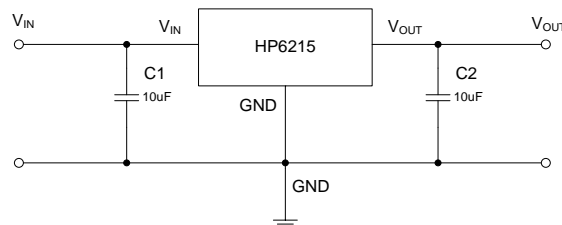

PIN ASSIGNMENT



HP6215T3

SOT89-3L

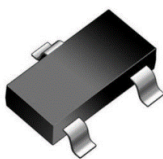
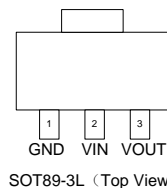

HP6215S3

SOT23-3L

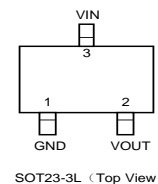

ORDER INFORMATION

PART NO	PACAKGE	TEMPERATURE	TAPE & REEL
HP6215S3-XX	SOT23-3L	-40 ~ +85°C	3000/REEL
HP6215T3-XX	SOT89-3L	-40 ~ +85°C	1000/REEL

"XX": several fixed output voltages ranging from 2.5V to 5.0V

PART NUMBER RULES

HP6215 [1] - [2]

Code	Description
[1]	Package: S3: SOT23-3L T3: SOT89-3L (B type pin-out)
[2]	Voltage version: XX: several fixed output voltages ranging from 2.5V to 5.0V Example: 33: 3.3V

MARKING DESCRIPTION:

SOT23-3L:

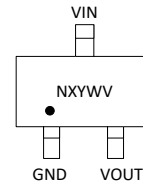

- "N": product code, here use "T" stands for "HP6215".
- "X": Internal Control Code
- "Y": Internal Control Code
- "W": The week of manufacturing. "A" stands for week 1, "Z" stands for week 26, "a" stands for week 27, "z" stands for week 52.
- "V": Output voltage code.

SOT89-3L:

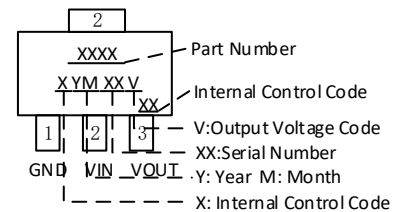

TYPICAL OUTPUT VOLTAGE CODE TABLE

V _{OUT}	CODE	V _{OUT}	CODE
2.8V	M	3.0V	G
3.3V	H	3.6V	I
4.0V	J	5.0V	K

PIN DESCRIPTION

PIN NO		SYMBOL	I/O	DESCRIPTION
HP6215T3	HP6215S3			
1	1	GND	Ground	Ground
2	3	VIN	Power	Input
3	2	VOUT	O	Output

ABSOLUTE MAXIMUM RATINGS (Note)

SYMBOL	ITEMS	VALUE	UNIT
V _{IN}	Input Voltage	-0.3~20	V
V _{OUT}	Output Voltage	-0.3~V _{IN}	V
P _{DMAX}	Power Dissipation	OTP Limited	W
T _J	Junction Temperature	-40~125	°C
T _{STG}	Storage Temperature	-55 to 150	°C
T _{SOLDER}	Package Lead Soldering Temperature	260°C, 10s	

Note: Exceed these limits to damage to the device. Exposure to absolute maximum rating conditions may affect device reliability.

RECOMMENDED OPERATING RANGE

SYMBOL	ITEMS	VALUE	UNIT
V _{IN}	V _{IN} Supply Voltage	3 to 16	V
R _{θJA}	Thermal Resistance on PCB	75	°C/W
T _{OPT}	Operating Temperature	-40 to +85	°C

ELECTRICAL CHARACTERISTICS

The following specifications apply for V_{OUT}=3.3V T_A=25°C, unless specified otherwise.

SYMBOL	ITEMS	CONDITIONS	MIN	TYP	MAX	UNIT
V _{IN}	Input Voltage		3	5	16	V
V _{OUT}	V _{OUT} Range	V _{IN} = V _{OUT} + 2 V, I _{OUT} = 1 mA	V _{OUT} *0.98	V _{OUT}	V _{OUT} *1.02	V
I _{OUT}	Output Current	Within Maximum Power Dissipation			500	mA
I _Q	Quiescent Current	No Load		2	3	μA
V _{DROP}	Dropout Voltage	V _{OUT} = 3.3 V, I _{OUT} = 100 mA, ΔV=2%		200	215	mV
		V _{OUT} = 5.0 V, I _{OUT} = 100 mA, ΔV=2%		115	130	
ΔV _{LINE}	Line Regulation	V _{IN} = 5~12V, I _{OUT} = 1 mA		0	6	mV
ΔV _{LOAD}	Load Regulation	V _{IN} = 12V, I _{OUT} = 1~100 mA		7	36	mV
I _{SHORT}	Short Current	V _{OUT} Short to GND with 3Ω		90	200	mA
ΔV _{OUT} /ΔT _a	Temperature coefficient	I _{OUT} =1mA, 0≤T _a ≤70°C		0.07	0.2	mV/°C
T _{SD}	Thermal Shutdown Protection	V _{IN} = V _{OUT} + 2 V, I _{OUT} = 1 mA	140	160	180	°C

SIMPLIFIED BLOCK DIAGRAM

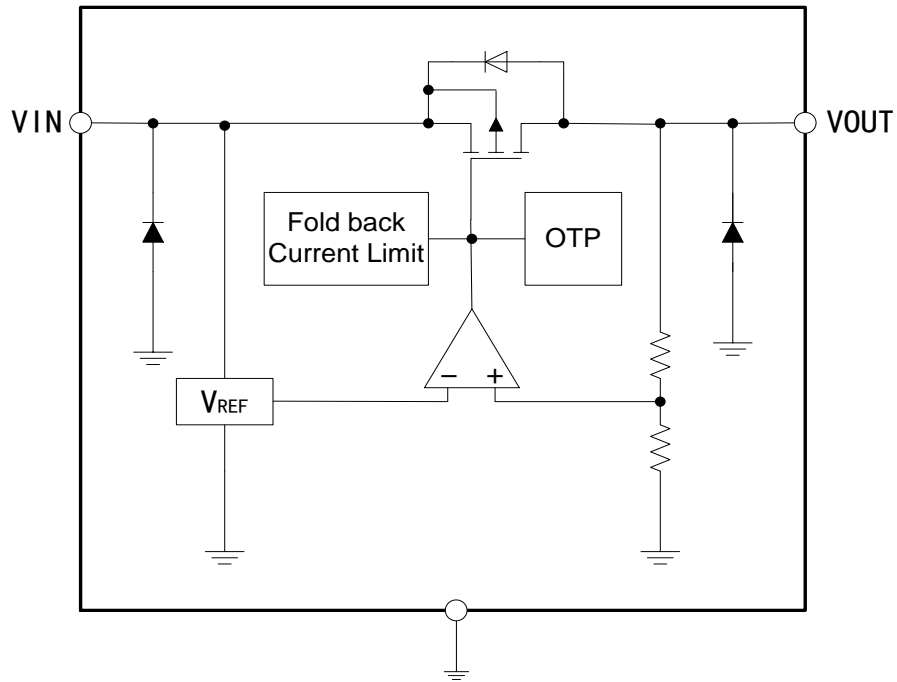

TYPICAL PERFORMANCE CHARACTERISTICS

$C_{IN}=10\mu F$, $C_{OUT}=10\mu F$, $T_{OPT}=25^{\circ}C$, $V_{IN}=5.3V$, $V_{OUT}=3.3V$, unless specified otherwise. (Package:SOT89-3L)

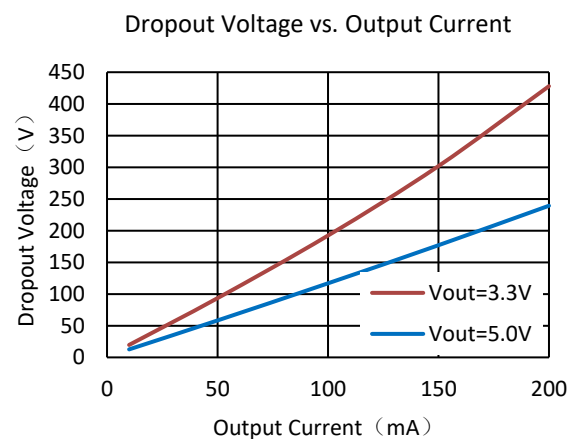
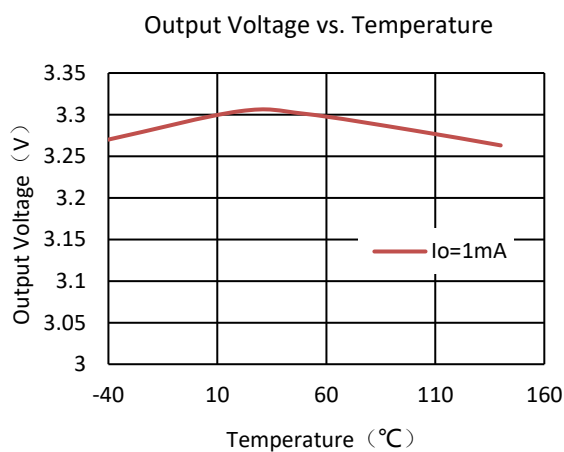
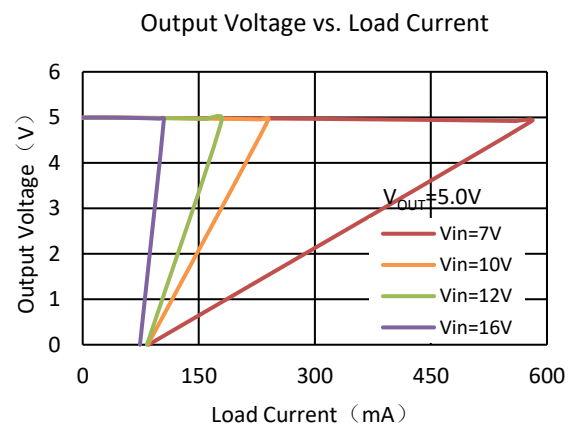
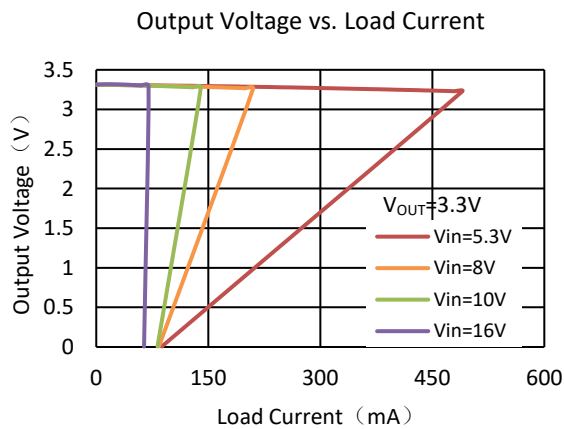
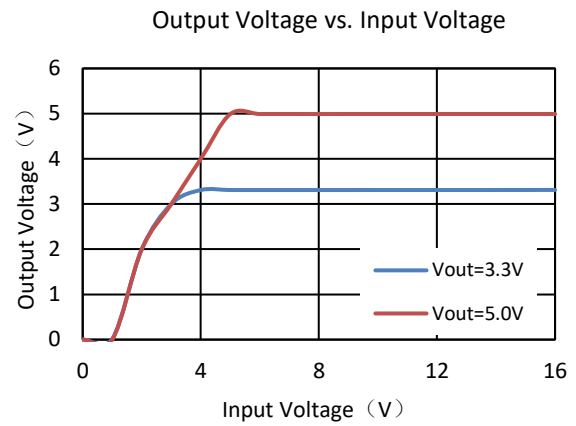
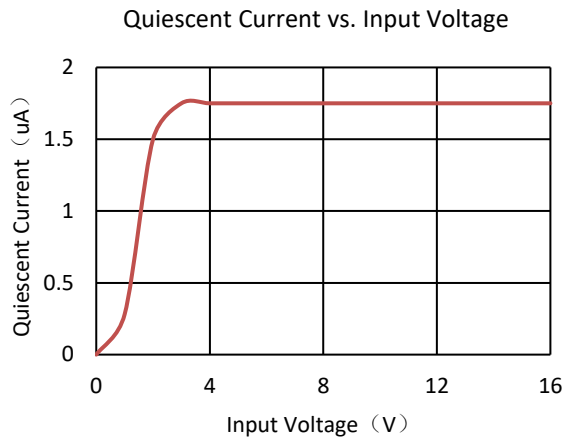

Power ON

CH1: V_{IN} CH2: V_{OUT}

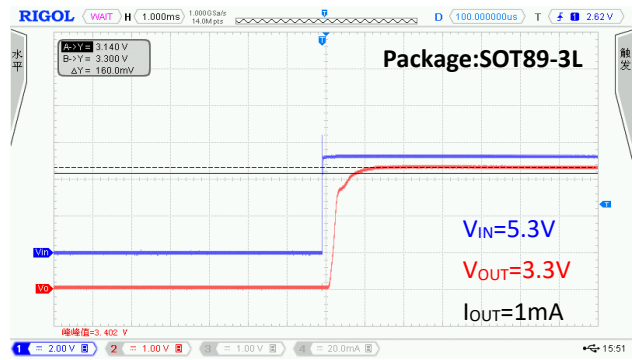
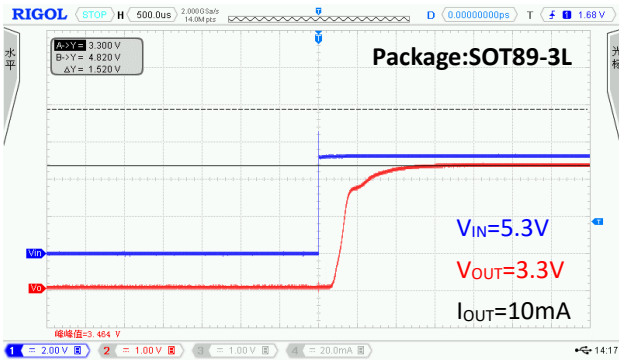

Line Transient

CH1: V_{IN} CH2: V_{OUT}

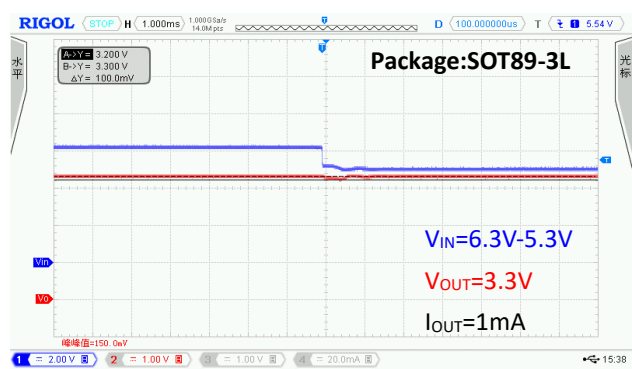
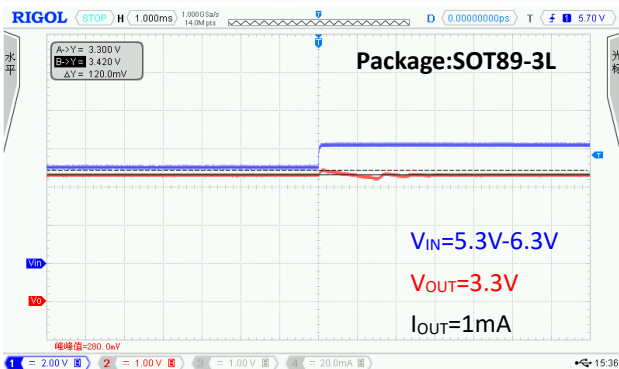
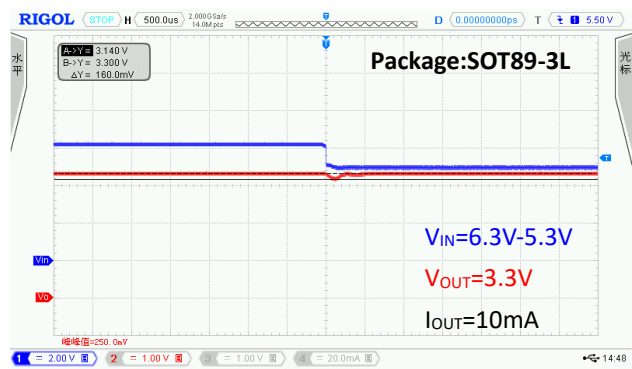
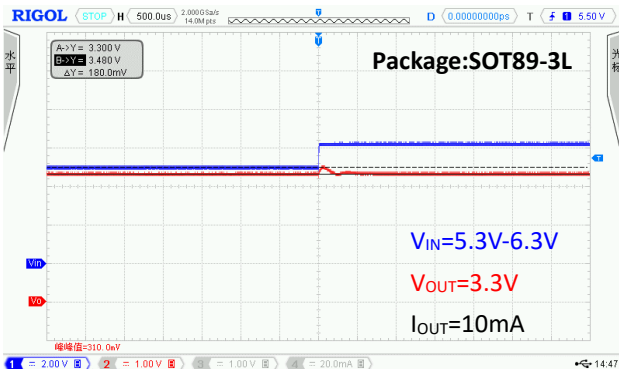

Load Transient

CH1: V_{IN} CH2: V_{OUT} CH4: I_{OUT}

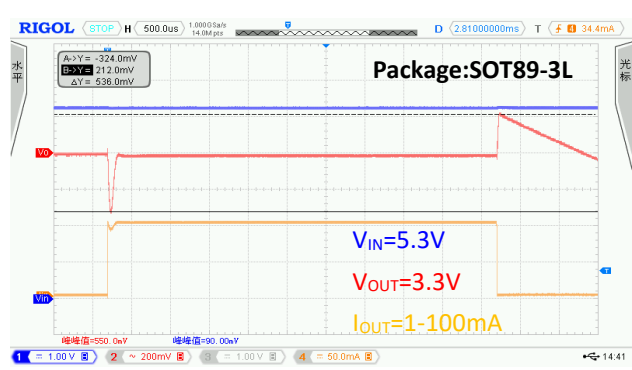
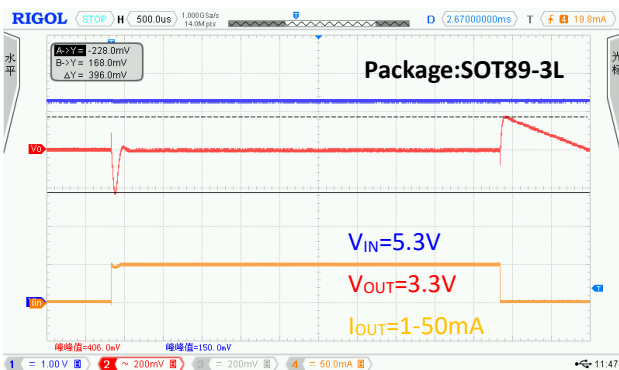

PACKAGE OUTLINE

Package	SOT23-3L	Devices per reel	3000Pcs	Unit	mm
Package Dimension:					
Symbol	Dimensions In Millimeters		Dimensions In Inches		
	Min	Max	Min	Max	
A	1.050	1.250	0.041	0.049	
A1	0.000	0.100	0.000	0.004	
A2	1.050	1.150	0.041	0.045	
b	0.300	0.500	0.012	0.020	
c	0.100	0.200	0.004	0.008	
D	2.820	3.020	0.111	0.119	
E	1.500	1.700	0.059	0.067	
E1	2.650	2.950	0.104	0.116	
e	0.950(BSC)		0.037(BSC)		
e1	1.800	2.000	0.071	0.079	
L	0.300	0.600	0.012	0.024	
θ	0°C	8°C	0°C	8°C	

PACKAGE OUTLINE

Package	SOT89-3L	Devices per reel	1000Pcs	Unit	mm
Package Dimension:					
Symbol	Dimensions In Millimeters		Dimensions In Inches		
	Min	Max	Min	Max	
A	1.400	1.600	0.055	0.063	
b	0.320	0.520	0.013	0.020	
b1	0.400	0.580	0.016	0.023	
c	0.350	0.440	0.014	0.017	
D	4.400	4.600	0.173	0.181	
D1	1.550 REF		0.061 REF		
D2	1.750 REF		0.069 REF		
E	2.300	2.600	0.091	0.102	
E1	3.940	4.250	0.155	0.167	
E2	1.900 REF		0.075 REF		
e	1.500 TYP		0.060 TYP		
e1	3.000 TYP		0.118 TYP		
L	0.900	1.200	0.035	0.047	
θ	45°		45°		

Revision History

Version No.	Date	Description
Preliminary	2017-05-12	Initial preliminary release
Version 0.1	2017-12-15	-Update features -Update electrical characteristics -Update typical performance characteristics
Version 0.2	2018-01-15	-Update package description
Version 0.3	2018-01-23	-Update features description
Version 0.4	2018-03-02	-Add HP6215S3 product package
Version 1.0	2018-03-29	-Change HP6215T3B to HP6215T3 -Update marking description
Version 1.1	2018-05-16	-Update typical performance characteristics -Add OTP description
Version 1.2	2018-06-21	-Update electrical characteristics
Version 1.3	2018-06-22	-Update Part Number
Version 1.4	2018-10-31	-Add output voltage code table
Version 1.5	2019-12-02	Update marking description

X-ON Electronics

Largest Supplier of Electrical and Electronic Components

Click to view similar products for [hypower microelectronics manufacturer](#):

Other Similar products are found below :

[HP6215T3-50](#) [HP4054S5-435](#) [HP6003S3-33](#) [HP6215T3-30](#) [HP6513T3B-30](#) [HP6215S3-50](#) [HP6513S3-33](#) [HP4056E8-435](#) [HP6513T3B-50](#)
[HP6017S5-33](#) [HP6003S3-18](#) [PS9113](#) [HP6013AS5-30](#) [HP6513T3B-36](#) [HP6013AS5-29](#) [HP6013AS5-36](#) [HP4059D6-42](#) [HP6013AS5-15](#)
[HP6013AS5-28](#) [HP6013AS5-18](#) [HP6013AS5-25](#) [HP6513S5B-50](#) [HP6215S3-28](#) [HP4058S5-42](#) [HP4054S5-42](#) [HP6003S3-30](#) [HP6013AS5-12](#)
[HP6013AS5-27](#) [HP6014AS5-18](#) [HP6017S5-30](#) [HP6014AS5-30](#) [HP6003S-15](#) [HP6003S3-12](#) [HP6003S3-28](#) [HP6013AS5-10](#) [HP6513S5A-50](#)
[HP6013AS5-26](#) [HP6014AS5-28](#) [HP6513S5B-33](#) [HP4555D8-42](#) [HP4056E8-42](#) [HP4554D8-435](#) [HP4555D8-435](#) [HP4554D8-44](#) [HP6013AD4-18](#) [HP4059D6-44](#) [HP6013AD4-25](#) [HP4059D6-435](#)