

## **FWA6604 series**

## **Network Appliance**

## **User's Manual**



*Version 1.0*

**iBASE**

**IBASE TECHNOLOGY INC.**  
Bldg. G, 11F, No. 3-1, Yuan Qu St.,  
Nankang, Taipei, Taiwan, R.O.C.

TEL: +886-2-2655-7588  
FAX: +886-2-2655-7388  
E-mail: [sales@ibase.com.tw](mailto:sales@ibase.com.tw)

## Table of Contents

Table of Contents .....	1
Foreword .....	2
Chapter 1 Introduction .....	4
Chapter 2 System Specification .....	5
Chapter 3 Hardware Configuration.....	6
Chapter 4 Console Mode Information .....	11
Chapter 5 Opening the Chassis .....	13
Chapter 6 Installing CompactFlash Card .....	13
Chapter 7 Installing Memory Module.....	14
Chapter 8 Installing Mini PCI-e Module.....	14
Chapter 9 Installing 2.5" SSD .....	15
Chapter 10 Lock Power Connector .....	16

## Foreword

### Copyright© 2014 IBASE Technology INC. All Rights Reserved.

No part of this manual, including the products and software described in it, may be reproduced, transmitted, transcribed, stored in a retrieval system, or translated into any language in any form or by any means, except documentation kept by the purchaser for backup purposes, without the express written permission of IBASE Technology INC. ("IBASE").

Products and corporate names mentioned in this manual may or may not be registered trademarks or copyrights of their respective companies, and are used for identification purposes only. All trademarks are the property of their respective owners.

Every effort has been made to ensure that the contents of this manual are correct and up to date. However, the manufacturer makes no guarantee regarding the accuracy of its contents, and reserves the right to make changes without prior notice.

### Safety Information

FWA6604 is designed and tested to meet the latest standards of safety for information technology equipment. However, to ensure your safety, it is important that you read the following safety instructions.

### Setting up your system

- Read and follow all instructions in the documentation before you operate your system.
- Do not use this product near water.
- Set up the system on a stable surface or secure on wall with the provided rail. Do not secure the system on any unstable plane or without the rail.
- Do not place this product on an unstable cart, stand, or table. The product may fall, causing serious damage to the product.
- Slots and openings on the chassis are for ventilation. Do not block or cover these openings. Make sure you leave plenty of space around the system for ventilation. Never insert objects of any kind into the ventilation openings.
- This system should be operated from the type of power indicated on the marking label. If you are not sure of the type of power available, consult your dealer or local power company.
- Use this product in environments with ambient temperatures between 0°C and 40°C.
- If you use an extension cord, make sure that the total ampere rating of the devices plugged into the extension cord does not exceed its ampere rating.

### Care during use

- Do not walk on the power cable or allow anything to rest on it.
- Do not spill water or any other liquids on your system.
- When the system is turned off, a small amount of electrical current still flows.
- Always unplug all power, and network cables from the power outlets before cleaning the system.
- If you encounter the following technical problems with the product, unplug the power cord and contact a qualified service technician or your retailer.
  - The power cable or plug is damaged.
  - Liquid has been spilled into the system.
  - The system does not function properly even if you follow the operating instructions.
  - The system was dropped or the cabinet is damaged.

### Lithium-Ion Battery Warning

**CAUTION:** Danger of explosion if battery is incorrectly replaced. Replace only with the same or equivalent type recommended by the manufacturer. Dispose of used batteries according to the manufacturer's instructions.

## **NO DISASSEMBLY**

The warranty does not apply to the products that have been disassembled by users

## **Federal Communications Commission Statement**

This device complies with Part 15 of the FCC Rules. Operation is subject to the following two conditions:

- This device may not cause harmful interference, and
- This device must accept any interference received including interference that may cause undesired operation.

This equipment has been tested and found to comply with the limits for a Class A digital device, pursuant to Part 15 of the FCC Rules. These limits are designed to provide reasonable protection against harmful interference in a residential installation. This equipment generates, uses and can radiate radio frequency energy and, if not installed and used in accordance with manufacturer's instructions, may cause harmful interference to radio communications. However, there is no guarantee that interference will not occur in a particular installation. If this equipment does cause harmful interference to radio or television reception, which can be determined by turning the equipment off and on, the user is encouraged to try to correct the interference by one or more of the following measures:

- Reorient or relocate the receiving antenna.
- Increase the separation between the equipment and receiver.
- Connect the equipment to an outlet on a circuit different from that to which the receiver is connected.
- Consult the dealer or an experienced radio/TV technician for help.

**CAUTION:** Any changes or modifications not expressly approved by the grantee of this device could void the user's authority to operate the equipment.

## **CE Mark Warning**

This is a Class A product, in a domestic environment, this product may cause radio interference, in which case the user may be required to take adequate measures.



## **Chapter 1 Introduction**

**The FWA6604 series was specifically designed for the network security & management market.**

### **Network Security Applications:**

- **Firewall**
- **Virtual Private Network**
- **Proxy Server**
- **Caching Server**

### **Network Management Applications:**

- **Load balancing**
- **Quality of Service**
- **Remote Access Service**

**The FWA network appliance product line covers the spectrum from offering platforms designed for :**

- **SOHO**
- **SMB**
- **Enterprise**

**Each product is designed to address the distinctive requirements of its respective market segment from cost effective entry-level solutions to high throughput and performance-bound systems for the Enterprise level.**

## Chapter 2 System Specification

### Product Description

FWA6604 incorporates Intel® SoC. Currently, it is available in the following model:

Model	Intel® SoC		Fanless	2.5" HDD Support
FWA6604-1C	Atom™ E3815	1.46 GHz	Yes	Yes
FWA6604-4C	Celeron® J1900	2.00 GHz	No	Yes

#### FWA6604 Features

- Supports four intel® 10/100/1000 LAN ports
- DDR3L SO-DIMM x 1, up to 4GB
- Half-sized Mini PCI-e slot & Compact Flash socket

### FWA6604 Specifications

CPU Type	FWA6604-1C: Intel® Atom™ Single core processor E3815 (512K cache, 1.46 GHz)
Operating Frequency	FWA6604-4C: Intel® Celeron® Quad cores processor J1900 (2M cache, 2.0 GHz)
BIOS	AMI BIOS w/ACPI
Ethernet controller	Intel® I211-AT PCI Express Gigabit ethernet controller x4
Memory	CPU on-die memory controller supporting up to 4GB One DDR3L-1600 SO-DIMM socket, Non-ECC, unbuffered, 1.35V
LAN	<ul style="list-style-type: none"> <li>• Console: RS-232 @ RJ45</li> <li>• Eth1, 2, 3 &amp; 4: Intel® I211-AT @ RJ45 with LED</li> </ul>
Network Bypass	One segment IBASE Advanced Bypass (Eth3 & 4) Control by GPIO / Watchdog
Watchdog Timer	Yes (256 segments, 0, 1, 2...255 sec/min)
Storage	<ul style="list-style-type: none"> <li>• Onboard CF socket x1</li> <li>• 7-pin SATA connector x1</li> </ul>
Rear Panel	<ul style="list-style-type: none"> <li>• Cylindrical (Tip) Connector DC +12V inlet with Screw Lock</li> <li>• Factory Mode Restore Reset Switch (GPIO control)</li> <li>• Power On / Off Switch</li> <li>• Optional opening for Wireless LAN antenna</li> <li>• RJ45 x1 for Console</li> <li>• RJ45 with LED x4 for Gigabit LAN</li> <li>• USB 2.0 x1</li> </ul>
Front Panel	<ul style="list-style-type: none"> <li>• LED: Power (Green) / Alarm (Red) / Status (Yellow)</li> <li>• LAN Speed LED (Yellow / Green) x4</li> <li>• LAN Link / Act LED (Green) x4</li> </ul>
USB 2.0	USB 2.0 x4 <ul style="list-style-type: none"> <li>• External x2</li> <li>• [2x4] Pin header Onboard x1</li> <li>• Mini PCI-e Socket x1</li> </ul>
Video	VGA pin header on board (IBASE VGA8 cable)
Internal I/O Headers	<ul style="list-style-type: none"> <li>• 4-pin Smart Fan Connector x1</li> <li>• 2-pin header for DC-in (12V) x1</li> </ul>
Expansion Interface	Half-sized Mini PCI-e socket x1
Power Supply	Full range 40W Adapter / 12V
Dimensions	187(W) x 115.8(D) x 44(H) mm
Operation Temperature	FWA6601-1C: 0 ~ 40 °C (32 ~ 104 °F) FWA6601-4C: 0 ~ 45 °C (32 ~ 113 °F)
Storage Temperature	-20 ~ 70 °C (-4 ~ 158 °F)

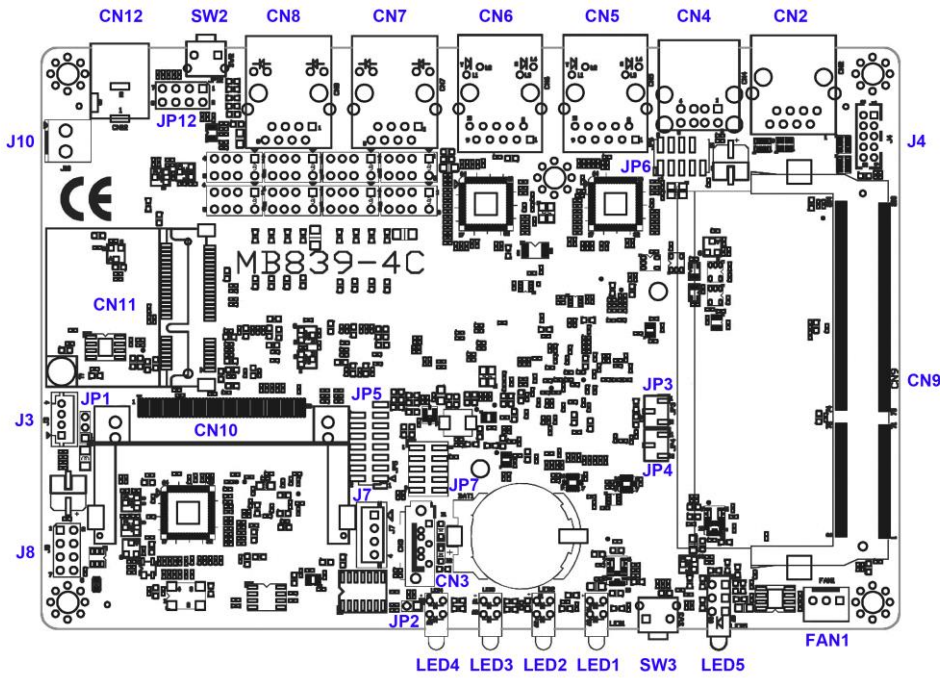

### Motherboard (MB839 Series) Layout





#### JP2: BIOS Flash Security Setting

Pin #	Signal Name
1	GND
2	I2S_2_TXD

#### JP3: Clear CMOS Setting

JP2	Setting
	Normal
	Clear CMOS

#### JP4: Clear ME Setting

JP3	Setting
	Normal
	Clear ME

#### JP5: VGA Connectors



Signal Name	Pin #	Pin #	Signal Name
VGA_R	1	2	VGA_PWR
VGA_G	3	4	GND
VGA_B	5	6	NC
NC	7	8	VGADDCDATA
GND	9	10	HSYNC
GND	11	12	VSYNC
GND	13	14	VGADDCCCLK
GND	15		

#### JP6: LPC Debug Port

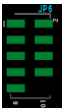

Signal Name	Pin #	Pin #	Signal Name
LPC_AD0	1	2	SIO_PLTRST#
LPC_AD1	3	4	LPC_FRAME#
LPC_AD2	5	6	+3.3V
LPC_AD3	7	8	Ground
LPC_CLK	9		

#### JP7: SPI Debug Port



Signal Name	Pin #	Pin #	Signal Name
NC	1	2	NC
SPI_CS#0	3	4	+1.8V
SPI_SO	5	6	SPI0_HOLD#
SPI0_WP#	7	8	SPI_CLK
GND	9	10	SPI_SI

#### JP12: System Function Connector

JP12 provides connectors for system indicators that provide light indication of the computer activities and switches to change the computer status. JP12 is a 8-pin header that provides interfaces for the following functions



##### Pin 1,2: Power LED

The power LED indicates the status of the main power switch.

Pin #	Signal Name
1	+5V
2	GND

##### Pin 3,4: ATX Power ON Switch

Pin 3 & 4 are for "ATX Power Supply On/Off Switch" on the system that connects to the power switch on the case. When pressed, the power switch will force the system to power on. When pressed again, it will force the system to power off.

Pin #	Signal Name
3	Power_ON
4	GND



**Pin 5, 6: Hard Disk Drive LED Connector**

This connector connects to the hard drive activity LED on control panel. This LED will flash when the HDD is being accessed.

Pin #	Signal Name
5	+3.3V
6	-HDD_LED

**Pin 7, 8: Reset Switch**

The reset switch allows the user to reset the system without turning the main power switch off and then on again. Orientation is not required when making a connection to this header.

Pin #	Signal Name
7	PM_SYSRST#
8	GND

**J3: MCU Update (Factory use only)**

**J4: Serial Port (COM2)**



Signal Name	Pin #	Pin #	Signal Name
DCD#	1	6	DSR#
SIN	2	7	RTS#
SOUT	3	8	CTS#
DTR#	4	9	RI#
GND	5		

**J7: SATA Power Connector**



Pin #	Signal Name
1	+5V
2	Ground
3	Ground
4	+12V

**J8 : USB 2.0 Pin Header**



Signal Name	Pin #	Pin #	Signal Name
NC	1	2	GND
NC	3	4	D+
NC	5	6	D-
GND	7	8	+5V

**J10: AT\_12V Connector**

DC-in internal connector supports +12V.



Pin #	Signal Name
1	+12V
2	Ground

Remarks: Do not connect CN12 and J10 at the same time.

**FAN1: System Fan Power Connector**

Pin header for system fan. The fan must be 12V (Max. 1A).



Pin #	Signal Name
1	Ground
2	+12V
3	Rotation Control

**LED1, LED2, LED3, LED4: LAN Port Link, Active LED**

**LED5: Status LED**

- A1 & C1 : Status LED
- A2 & C2 : Bypass LED
- A3 & C3 : Power LED



Signal Name	Pin #	Pin #	Signal Name
SIO_GP27	A1	C1	SIO_GP26
ALARM_R	A2	C2	BY_LED_R
PWR_R	A3	C3	GND

Index port: 4E  
 Data port: 4F  
 Device: 07  
 F5h → bit5, bit6 (Control pin)

**SW3: Software reset button**



Signal Name	Pin #	Pin #	Signal Name
GND	1	2	Intel SoC GPIO7

IO Base:  
 Read memory 0 x fed0e238 and set bit 1 to "1" as (GPI ),  
 set bit 1 to "0" as (GPO )  
 Read memory 0 x fed0e238 and check the bit 0 (Control Pin)  
 Note: SW3 is controlled by GPIO only.

**CN2: Console Port (COM1)**



Pin #	Signal Name (RS-232)
1	RTS, Request to send
2	DTR, Data terminal ready
3	TXD, Transmit data
4	Ground
5	Ground
6	RXD, Receive data

7	DSR, Data set ready
8	CTS, Clear to send

**CN3: Serial ATA Port**

**CN4: USB2.0 Ports**

**CN5, CN6, CN7, CN8: LAN 1G / 100M Port**

**CN9: SO-DIMM DDR3 Socket**

**CN10: Compact Flash Connector**

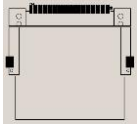

*Note: CF card supports IDE mode only.  
If CF card applied, please set the SATA configuration to "IDE mode" in BIOS.*

**CN11: Mini PCI- E Connector (Half size)**

**CN12 : DC Power Jack (+12V only)**

*Note: CN12 and J10 cannot be connected at the same time.*

## Chapter 4 Console Mode Information

### **FWA6604 supports output information via Console in BIOS level.**

Prepare a computer as client loaded with an existing OS such Windows XP.

Connect client computer and FWA6604 with NULL Modem cable.

Follow the steps below to configure the Windows Hyper Terminal application setting:

1. For executing the Hyper Terminal, issue command "hypertrm".
2. Customize your name for the new connection.

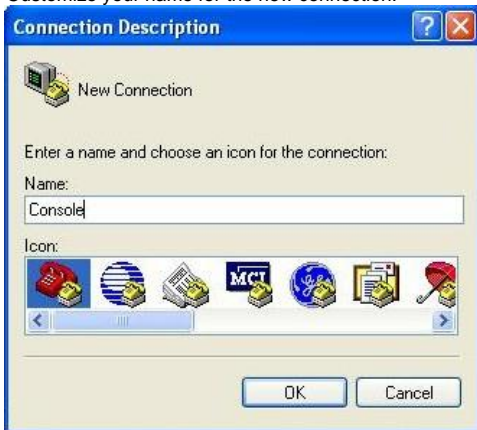

3. Choose the COM port on the client computer for the connection.



4. Please make the port settings to Baud rate 115200, Parity None, Data bits 8, Stop bits 1

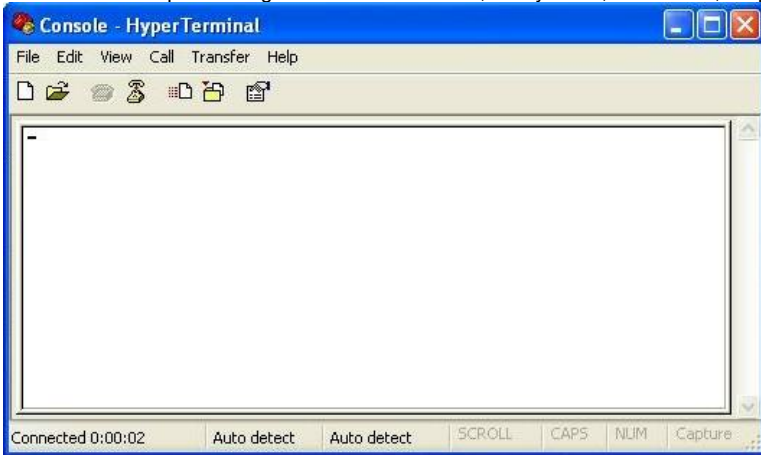

5. Power up FWA6604 and the screen will display the BIOS information.
6. Press **<Tab>** key to enter BIOS setup screen in **Console mode**.  
Press **<Del>** key to enter BIOS setup screen in **VGA mode**.

## Chapter 5 Opening the Chassis



Fig. 5-1 Loosen three screws on side and bottom

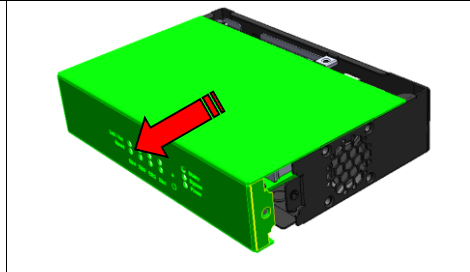

Fig. 5-2 Remove the top cover

格式化: 項目符號及編號

## Chapter 6 Installing CompactFlash Card

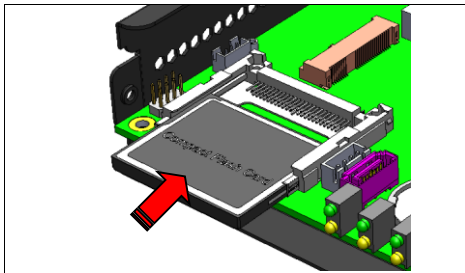

Fig. 6-1 Insert Compact Flash Card

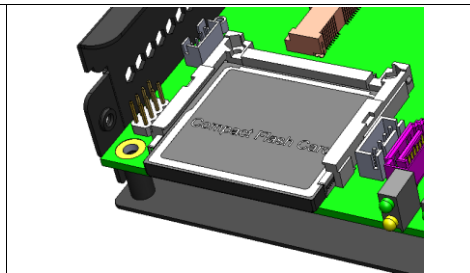

Fig. 6-2 Push Compact Flash Card into the CF interface

## Chapter 7 Installing Memory Module

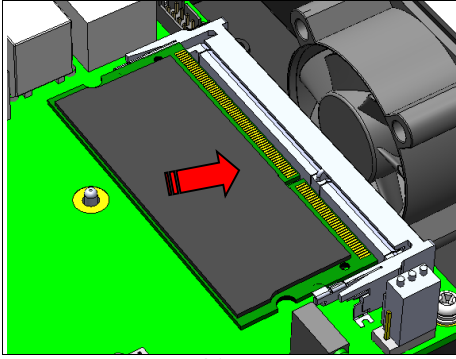

Fig. 7-1 Insert DDR3L SO-DIMM memory module

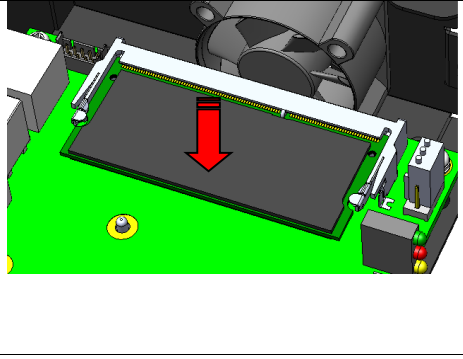

Fig. 7-2 Press down the memory module into socket

## Chapter 8 Installing Mini PCI-e Module

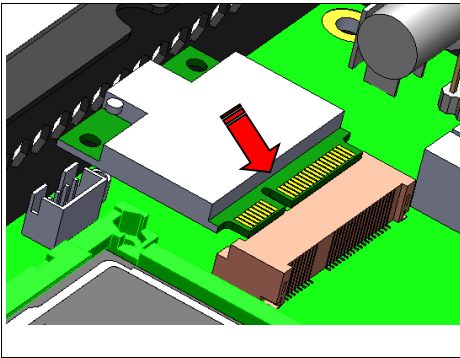

Fig. 8-1 Insert Half-sized Mini PCI-e module

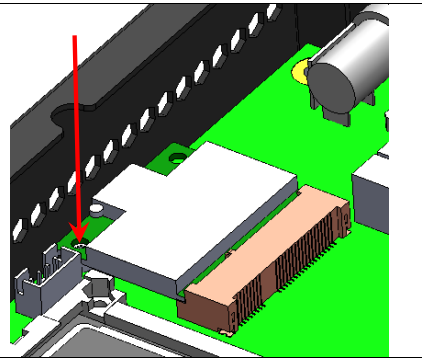

Fig. 8-2 Push down the module into socket & tighten one M2 screw

## Chapter 9 Installing 2.5" HDD / SSD

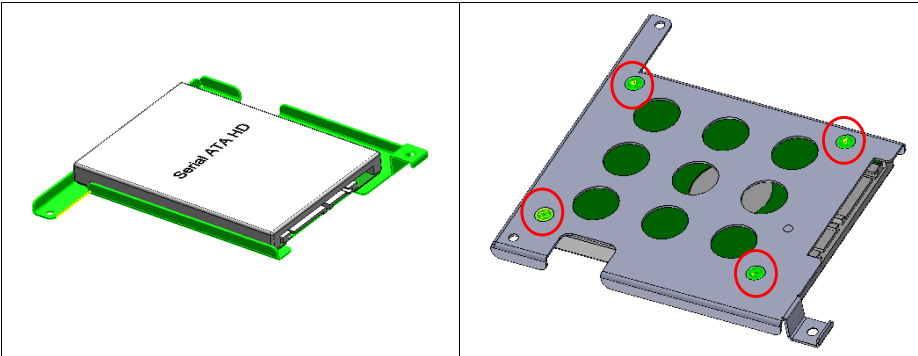

Fig. 9-1 Put 2.5" HDD / SSD onto the bracket

Fig. 9-2 Fasten HDD on bracket with four M3 Flat screws

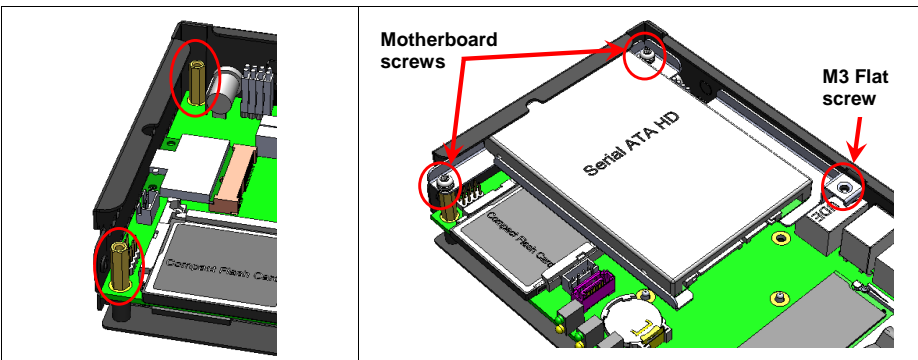

Fig. 9-3 Remove two motherboard screws and fasten two standoffs

Fig. 9-4 Fix HDD bracket with two motherboard screws and one Flat screw.

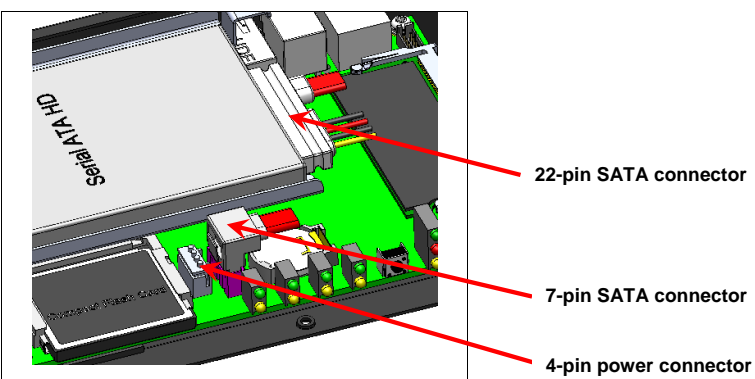
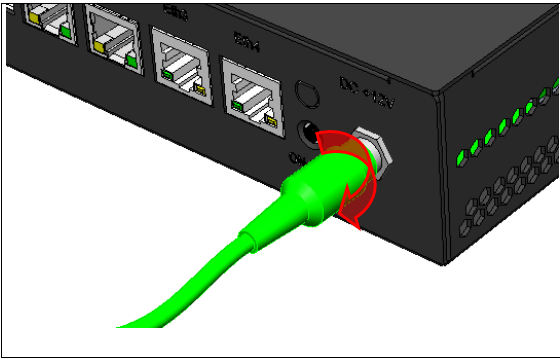

Fig. 9-5 Plug SATA cable



## Chapter 10 Lock Power Connector



**Fig. 10-1** Plug power connector into power jack

## X-ON Electronics

Largest Supplier of Electrical and Electronic Components

*Click to view similar products for [Networking Modules](#) category:*

*Click to view products by [Ibase](#) manufacturer:*

Other Similar products are found below :

[MS25041-4-327](#) [SE305-T](#) [509FX-SC](#) [SE308-T](#) [FCOPPER-SFP-100](#) [75070R-70](#) [75060R-40](#) [301-2010-27](#) [DC-ES-4SB-EU](#)  
[MGM111E256V2](#) [LTP5901IPC-IPRB1C1#PBF](#) [LTP5901IPC-IPRC1C2#PBF](#) [LTP5901IPC-IPRC1C1#PBF](#) [LTP5901IPC-IPRB1C2#PBF](#)  
[LTP5901IPC-IPRA1C2#PBF](#) [VSMD001V072](#) [65440R](#) [2000000844](#) [2000000849](#) [WISE-1020-0C01E](#) [WISE-1020-0S01E](#) [WISE-1021WR-1100E](#) [RAPID-NI-V2005](#) [RAPID-NI-V2011](#) [RAPID-NI-V2105](#) [855-19619](#) [X2E-Z1C-W1-W](#) [X2E-Z4C-D2-A](#) [PuIM-1G4T-I211-BP-R10](#)  
[PuIM-1G4T-I211-R10](#) [PUZZLE-IN003B-C0/8G-R10](#) [XXV710DA2OCP2](#) [MO11AA003-01R](#) [WP20010NMK-01](#) [WP500100S-01](#)  
[XP1001000-05R](#) [XP1001000M-05R](#) [XP100200S-05R](#) [XPDNC2000-01](#) [XPP100200S-02R](#) [112113-0001](#) [112113-0007](#) [1203630001](#) [SST-DN4-PCU](#) [2200515](#) [XpressV7-LP690HE-Gen3](#) [113990838](#) [SD-300-US](#) [MGM13P02F512GA-V2](#) [MGM13S02F512GA-V3](#)