



AiP74AHC1G09

Single 2-input And Gate (open drain)

Product Specification

Specification Revision History:

Version	Date	Description
2018-10-A1	2018-10	New
2021-09-A2	2021-09	Modify ambient temperature to -40°C~+105°C and add electrical characteristics of -40°C~+105°C
2021-10-A3	2021-10	Modify Ordering Information
2021-12-A4	2021-12	Modify Ordering Information
2022-03-A5	2022-03	Modify ordering information note 1



1、 General Description

The AiP74AHC1G09 is a high-speed Si-gate CMOS device.

The AiP74AHC1G09 provides the 2-input AND function with open-drain output.

The output of the AiP74AHC1G09 is an open drain and can be connected to other open-drain outputs to implement active-LOW, wired-OR or active-HIGH wired-AND functions. For digital operation this device must have a pull-up resistor to establish a logic HIGH level.

Features:

- Wide supply voltage range from 2V to 5.5V
- Low power consumption
- Specified from -40°C to +105°C
- Packaging information: SOT-23-5/SOT-353

Ordering Information:

Reel packing specifications:

Part number	Packaging form	Marking code	Reel quantity	Boxed reel quantity	Notes
AiP74AHC1G09GB235.TR	SOT-23-5	BZXX	3000 PCS/reel	30000 PCS/box	Dimensions of plastic enclosure: 2.9mm×1.6mm Pin spacing:0.95mm
AiP74AHC1G09GC353.TR	SOT-353	BZXX	3000 PCS/reel	30000 PCS/box	Dimensions of plastic enclosure: 2.1mm×1.3mm Pin spacing:0.65mm

Note 1: "XX" refers to variable content, meaning year and package batch serial number.

Note 2: If the physical information is inconsistent with the ordering information, please refer to the actual product.



2、Block Diagram And Pin Description

2.1、Block Diagram

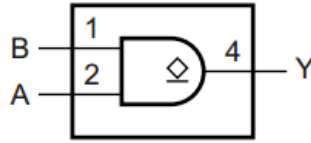

Figure 1. Logic symbol



Figure 2. IEC logic symbol

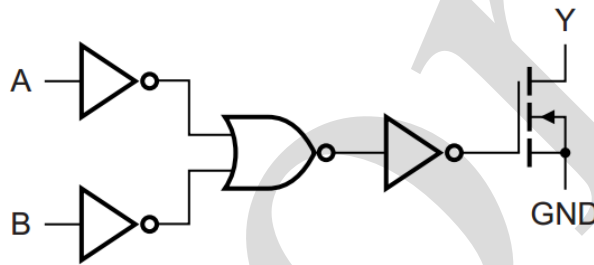
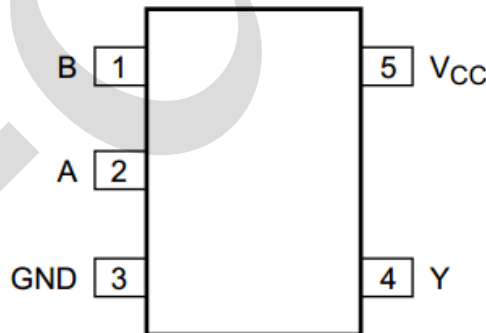

Figure 3. Logic diagram

2.2、Pin Configurations



2.3、Pin Description

Pin No.	Pin Name	Description
1	B	data input B
2	A	data input A
3	GND	ground (0V)
4	Y	data output Y
5	V _{CC}	supply voltage



2.4、Function Table

Input		Output
A	B	Y
L	L	L
L	H	L
H	L	L
H	H	Z

Note: H=HIGH voltage level; L=LOW voltage level; Z=high-impedance OFF-state.

3、Electrical Parameter

3.1、Absolute Maximum Ratings

(Voltages are referenced to GND (ground=0V), unless otherwise specified.)

Parameter	Symbol	Conditions	Min.	Max.	Unit
supply voltage	V_{CC}	-	-0.5	+7.0	V
input voltage	V_I	-	-0.5	+7.0	V
input clamping current	I_{IK}	$V_I < -0.5V$	-20	-	mA
output clamping current	I_{OK}	$V_O < -0.5V$	-	± 20	mA
output voltage	V_O	Active mode	-0.5	+7.0	V
		High-impedance mode	-0.5	+7.0	V
output current	I_O	$V_O > -0.5V$	-	25	mA
supply current	I_{CC}	-	-	75	mA
ground current	I_{GND}	-	-75	-	mA
storage temperature	T_{stg}	-	-65	+150	$^{\circ}C$
total power dissipation	P_{tot}	-	-	250	mW
Soldering temperature	T_L	10s	250		$^{\circ}C$

3.2、Recommended Operating Conditions

Parameter	Symbol	Conditions	Min.	Typ.	Max.	Unit
supply voltage	V_{CC}	-	2.0	5.0	5.5	V
input voltage	V_I	-	0	-	5.5	V
output voltage	V_O	Active mode	0	-	V_{CC}	V
		High-impedance mode	0	-	6.0	V
ambient temperature	T_{amb}	-	-40	-	+105	$^{\circ}C$
input transition rise and fall rate	$\Delta t/\Delta V$	$V_{CC}=3.0V$ to $3.6V$	-	-	100	ns/V
		$V_{CC}=4.5V$ to $5.5V$	-	-	20	ns/V



3.3、Electrical Characteristics

3.3.1、DC Characteristics 1

($T_{amb}=25^{\circ}\text{C}$, voltages are referenced to GND (ground=0V), unless otherwise specified.)

Parameter	Symbol	Conditions	Min.	Typ.	Max.	Unit	
HIGH-level input voltage	V_{IH}	$V_{CC}=2.0\text{V}$	1.5	-	-	V	
		$V_{CC}=3.0\text{V}$	2.1	-	-	V	
		$V_{CC}=5.5\text{V}$	3.85	-	-	V	
LOW-level input voltage	V_{IL}	$V_{CC}=2.0\text{V}$	-	-	0.5	V	
		$V_{CC}=3.0\text{V}$	-	-	0.9	V	
		$V_{CC}=5.5\text{V}$	-	-	1.65	V	
LOW-level output voltage	V_{OL}	$V_I = V_{IH} \text{ or } V_{IL}$	$I_O=50\mu\text{A}; V_{CC}=2.0\text{V}$	-	0	0.1	V
			$I_O=50\mu\text{A}; V_{CC}=3.0\text{V}$	-	0	0.1	V
			$I_O=50\mu\text{A}; V_{CC}=4.5\text{V}$	-	0	0.1	V
			$I_O=4\text{mA}; V_{CC}=3.0\text{V}$	-	-	0.36	V
			$I_O=8\text{mA}; V_{CC}=4.5\text{V}$	-	-	0.36	V
input leakage current	I_I	$V_I=5.5\text{V}$ or GND; $V_{CC}=0\text{V}$ to 5.5V	-	-	± 0.1	μA	
OFF-state output current	I_{OZ}	$V_I = V_{IH} \text{ or } V_{IL}; V_O = V_{CC} \text{ or } \text{GND};$ $V_{CC}= 5.5 \text{ V}$	-	-	± 0.25	μA	
supply current	I_{CC}	$V_I=V_{CC}$ or GND; $I_O=0\text{A};$ $V_{CC}= 5.5\text{V}$	-	-	1.0	μA	
input capacitance	C_I	-	-	1.5	10	pF	

3.3.2、DC Characteristics 2

($T_{amb}=-40^{\circ}\text{C}$ to $+85^{\circ}\text{C}$, voltages are referenced to GND (ground=0V), unless otherwise specified.)

Parameter	Symbol	Conditions	Min.	Typ.	Max.	Unit	
HIGH-level input voltage	V_{IH}	$V_{CC}=2.0\text{V}$	1.5	-	-	V	
		$V_{CC}=3.0\text{V}$	2.1	-	-	V	
		$V_{CC}=5.5\text{V}$	3.85	-	-	V	
LOW-level input voltage	V_{IL}	$V_{CC}=2.0\text{V}$	-	-	0.5	V	
		$V_{CC}=3.0\text{V}$	-	-	0.9	V	
		$V_{CC}=5.5\text{V}$	-	-	1.65	V	
LOW-level output voltage	V_{OL}	$V_I = V_{IH} \text{ or } V_{IL}$	$I_O=50\mu\text{A}; V_{CC}=2.0\text{V}$	-	-	0.1	V
			$I_O=50\mu\text{A}; V_{CC}=3.0\text{V}$	-	-	0.1	V
			$I_O=50\mu\text{A}; V_{CC}=4.5\text{V}$	-	-	0.1	V
			$I_O=4\text{mA}; V_{CC}=3.0\text{V}$	-	-	0.44	V
			$I_O=8\text{mA}; V_{CC}=4.5\text{V}$	-	-	0.44	V
input leakage current	I_I	$V_I=5.5\text{V}$ or GND; $V_{CC}=0\text{V}$ to 5.5V	-	-	± 1.0	μA	
OFF-state output current	I_{OZ}	$V_I = V_{IH} \text{ or } V_{IL}; V_O = V_{CC} \text{ or } \text{GND};$ $V_{CC}= 5.5 \text{ V}$	-	-	± 2.5	μA	
supply current	I_{CC}	$V_I=V_{CC}$ or GND; $I_O=0\text{A};$ $V_{CC}= 5.5\text{V}$	-	-	10	μA	
input capacitance	C_I	-	-	-	10	pF	



3.3.3、DC Characteristics 3

($T_{amb}=-40^{\circ}\text{C}$ to $+105^{\circ}\text{C}$, voltages are referenced to GND (ground=0V), unless otherwise specified.)

Parameter	Symbol	Conditions	Min.	Typ.	Max.	Unit	
HIGH-level input voltage	V_{IH}	$V_{CC}=2.0\text{V}$	1.5	-	-	V	
		$V_{CC}=3.0\text{V}$	2.1	-	-	V	
		$V_{CC}=5.5\text{V}$	3.85	-	-	V	
LOW-level input voltage	V_{IL}	$V_{CC}=2.0\text{V}$	-	-	0.5	V	
		$V_{CC}=3.0\text{V}$	-	-	0.9	V	
		$V_{CC}=5.5\text{V}$	-	-	1.65	V	
LOW-level output voltage	V_{OL}	$V_I = V_{IH}$ or V_{IL}	$I_O=50\mu\text{A}; V_{CC}=2.0\text{V}$	-	-	0.1	V
			$I_O=50\mu\text{A}; V_{CC}=3.0\text{V}$	-	-	0.1	V
			$I_O=50\mu\text{A}; V_{CC}=4.5\text{V}$	-	-	0.1	V
			$I_O=4\text{mA}; V_{CC}=3.0\text{V}$	-	-	0.55	V
			$I_O=8\text{mA}; V_{CC}=4.5\text{V}$	-	-	0.55	V
input leakage current	I_I	$V_I=5.5\text{V}$ or GND; $V_{CC}=0\text{V}$ to 5.5V	-	-	± 2.0	μA	
OFF-state output current	I_{OZ}	$V_I = V_{IH}$ or $V_{IL}; V_O=V_{CC}$ or GND; $V_{CC}=5.5\text{V}$	-	-	± 10.0	μA	
supply current	I_{CC}	$V_I=V_{CC}$ or GND; $I_O=0\text{A}; V_{CC}=5.5\text{V}$	-	-	20	μA	
input capacitance	C_I	-	-	-	10	pF	

3.3.4、AC Characteristics 1

($T_{amb}=25^{\circ}\text{C}$, voltages are referenced to GND (ground=0V), unless otherwise specified.)

Parameter	Symbol	Conditions	Min.	Typ.	Max.	Unit	
A, B to Y propagation delay	t_{pd}	see Figure 5	$V_{CC}=3.0\text{V}$ to 3.6V				
			$C_L=15\text{pF}$	-	4.6	7.5	ns
			$C_L=50\text{pF}$	-	6.5	11.0	ns
			$V_{CC}=4.5\text{V}$ to 5.5V				
			$C_L=15\text{pF}$	-	3.2	5.5	ns
			$C_L=50\text{pF}$	-	4.6	7.5	ns
Power dissipation capacitance	C_{PD}	$C_L=50\text{pF}; f_i=1\text{MHz};$ $V_I=$ GND to V_{CC}	-	5	-	pF	

Note:

[1] t_{pd} is the same as t_{PZL} and t_{PLZ} .

[2] Typical values are measured at $V_{CC}=3.3\text{V}$ or 5V .

[3] C_{PD} is used to determine the dynamic power dissipation (P_D in μW).

$$P_D=(C_{PD}\times V_{CC}^2\times f_i\times N)+\sum(C_L\times V_{CC}^2\times f_o)$$
 where:

f_i =input frequency in MHz;

f_o =output frequency in MHz;

C_L =output load capacitance in pF;

V_{CC} =supply voltage in V;

N =number of inputs switching;

$\sum(C_L\times V_{CC}^2\times f_o)$ = dissipation due to the output if the combination of the pull up voltage and resistance results in V_{CC} at the output.



3.3.5、AC Characteristics 2

($T_{amb}=-40^{\circ}\text{C}$ to $+85^{\circ}\text{C}$, voltages are referenced to GND (ground=0V), unless otherwise specified.)

Parameter	Symbol	Conditions	Min.	Typ.	Max.	Unit	
A, B to Y propagation delay	t_{pd}	see Figure 5	$V_{CC}=3.0\text{V}$ to 3.6V				
			$C_L=15\text{pF}$	1.0	-	8.5	ns
			$C_L=50\text{pF}$	1.5	-	12.0	ns
			$V_{CC}=4.5\text{V}$ to 5.5V				
			$C_L=15\text{pF}$	1.0	-	6.5	ns
			$C_L=50\text{pF}$	1.5	-	8.0	ns

Note:

[1] t_{pd} is the same as t_{pZL} and t_{pLZ} .

[2] Typical values are measured at $V_{CC}=3.3\text{V}$ or 5V .

3.3.6、AC Characteristics 3

($T_{amb}=-40^{\circ}\text{C}$ to $+105^{\circ}\text{C}$, voltages are referenced to GND (ground=0V), unless otherwise specified.)

Parameter	Symbol	Conditions	Min.	Typ.	Max.	Unit	
A, B to Y propagation delay	t_{pd}	see Figure 5	$V_{CC}=3.0\text{V}$ to 3.6V				
			$C_L=15\text{pF}$	1.0	-	9.0	ns
			$C_L=50\text{pF}$	1.5	-	12.5	ns
			$V_{CC}=4.5\text{V}$ to 5.5V				
			$C_L=15\text{pF}$	1.0	-	7.0	ns
			$C_L=50\text{pF}$	1.5	-	8.5	ns

Note:

[1] t_{pd} is the same as t_{pZL} and t_{pLZ} .

[2] Typical values are measured at $V_{CC}=3.3\text{V}$ or 5V .

4、Testing Circuit

4.1、AC Testing Circuit

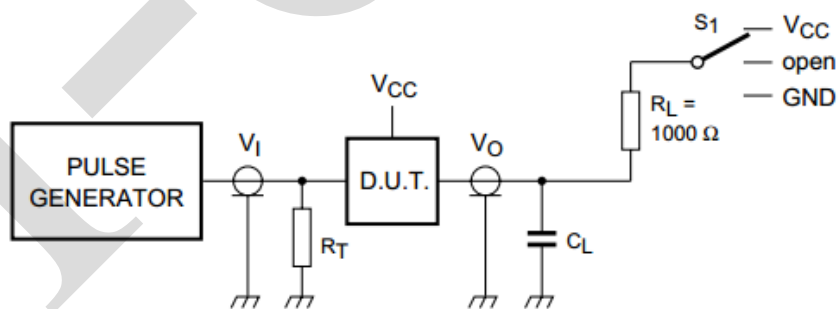

Figure 4. Load circuit for switching times

Definitions for test circuit:

C_L =Load capacitance including jig and probe capacitance.

R_T =Termination resistance should be equal to output impedance Z_o of the pulse generator.



4.2、AC Testing Waveforms

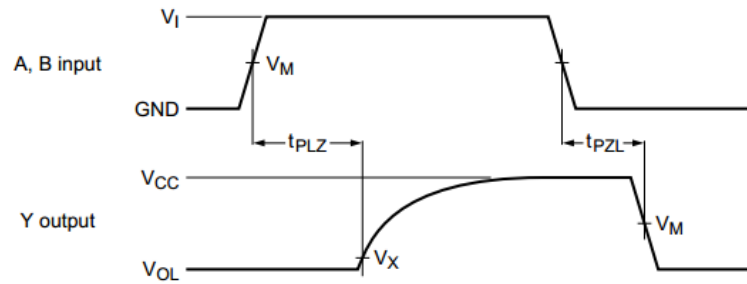

Figure 5. The data input (A, B) to output (Y) propagation delays

4.3、Measurement Points

Input	Output	
V_M	V_M	V_X
$0.5 \times V_{CC}$	$0.5 \times V_{CC}$	$V_{OL} + 0.3V$

4.4、Test Data

Input		Load		S1		
V_I	t_r, t_f	R_L	C_L	t_{PHZ}, t_{PZH}	t_{PLZ}, t_{PZL}	t_{PLH}, t_{PHL}
GND to V_{CC}	$\leq 3.0ns$	1000Ω	$15pF$	GND	V_{CC}	open
GND to V_{CC}	$\leq 3.0ns$	1000Ω	$50pF$	GND	V_{CC}	open



5、Package Information

5.1、SOT-23-5

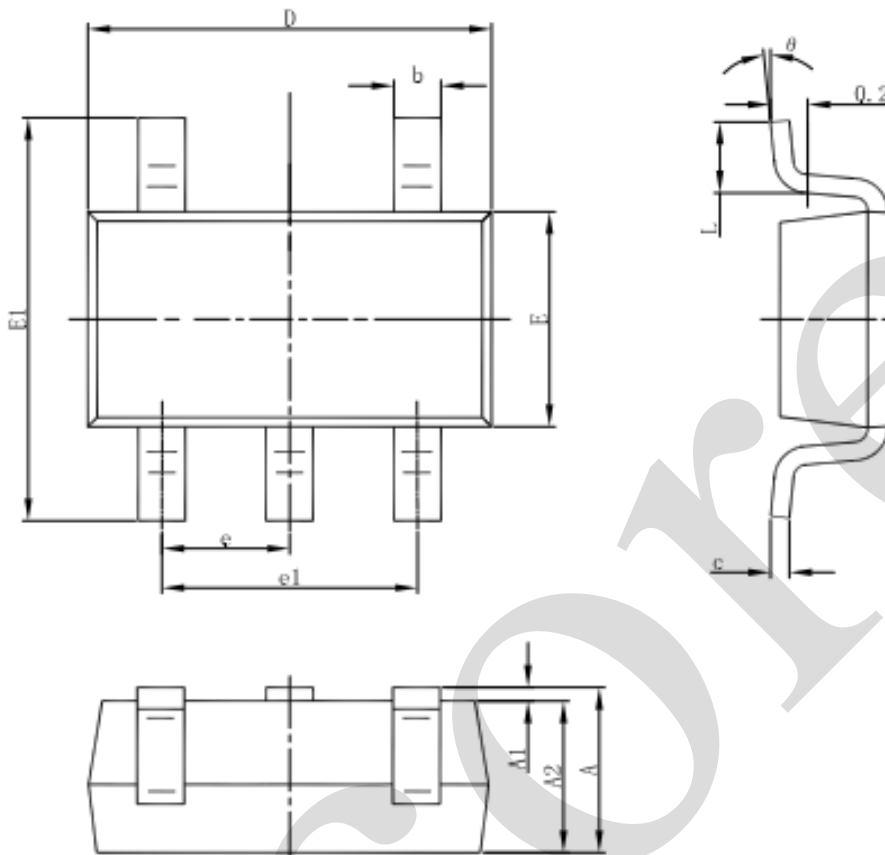

Symbol	Dimensions In Millimeters		Dimensions In Inches	
	Min	Max	Min	Max
A	1.050	1.250	0.041	0.049
A1	0.000	0.100	0.000	0.004
A2	1.050	1.150	0.041	0.045
b	0.300	0.500	0.012	0.020
c	0.100	0.200	0.004	0.008
D	2.820	3.020	0.111	0.119
E	1.500	1.700	0.059	0.067
E1	2.650	2.950	0.104	0.116
e	0.950(BSC)		0.037(BSC)	
e1	1.800	2.000	0.071	0.079
L	0.300	0.600	0.012	0.024
θ	0°	8°	0°	8°



5.2、SOT-353

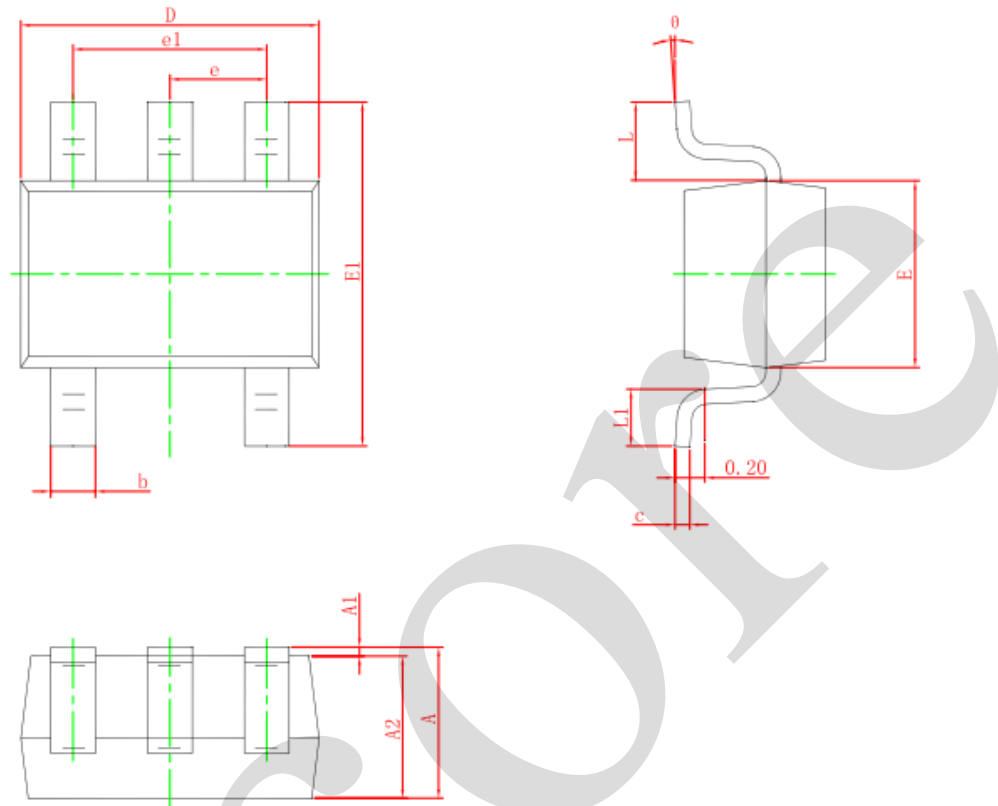

Symbol	Dimensions In Millimeters		Dimensions In Inches	
	Min.	Max.	Min.	Max.
A	0.900	1.100	0.035	0.043
A1	0.000	0.100	0.000	0.004
A2	0.900	1.000	0.035	0.039
b	0.150	0.350	0.006	0.014
c	0.080	0.150	0.003	0.006
D	2.000	2.200	0.079	0.087
E	1.150	1.350	0.045	0.053
E1	2.150	2.450	0.085	0.096
e	0.650 TYP.		0.026 TYP.	
e1	1.200	1.400	0.047	0.055
L	0.525 REF.		0.021 REF.	
L1	0.260	0.460	0.010	0.018
θ	0°	8°	0°	8°



6、 Statements And Notes

6.1、 The name and content of Hazardous substances or Elements in the product

Part name	Hazardous substances or Elements									
	Lead and lead compounds	Mercury and mercury compounds	Cadmium and cadmium compounds	Hexavalent chromium compounds	Polybrominated biphenyls	Polybrominated biphenyl ethers	Dibutyl phthalate	Butylbenzyl phthalate	Di-2-ethylhexyl phthalate	Diisobutyl phthalate
Lead frame	○	○	○	○	○	○	○	○	○	○
Plastic resin	○	○	○	○	○	○	○	○	○	○
Chip	○	○	○	○	○	○	○	○	○	○
The lead	○	○	○	○	○	○	○	○	○	○
Plastic sheet installed	○	○	○	○	○	○	○	○	○	○
explanation	○: Indicates that the content of hazardous substances or elements in the detection limit of the following the SJ/T11363-2006 standard. ×: Indicates that the content of hazardous substances or elements exceeding the SJ/T11363-2006 Standard limit requirements.									

6.2、 Notion

Recommended carefully reading this information before the use of this product;

The information in this document are subject to change without notice;

This information is using to the reference only, the company is not responsible for any loss;

The company is not responsible for the any infringement of the third party patents or other rights of the responsibility.

X-ON Electronics

Largest Supplier of Electrical and Electronic Components

Click to view similar products for [Logic Gates](#) category:

Click to view products by [I-core](#) manufacturer:

Other Similar products are found below :

[74HC85N](#) [NL17SG32DFT2G](#) [CD4068BE](#) [NL17SG86DFT2G](#) [NLV14001UBDR2G](#) [NLX1G11AMUTCG](#) [NLX1G97MUTCG](#) [74LS38](#)
[74LVC1G08Z-7](#) [74LVC32ADTR2G](#) [CD4025BE](#) [MC74HCT20ADTR2G](#) [NLV17SZ00DFT2G](#) [NLV17SZ126DFT2G](#) [NLV27WZ17DFT2G](#)
[NLV74HC02ADR2G](#) [74HC32S14-13](#) [74LS133](#) [74LVC1G32Z-7](#) [74LVC1G86Z-7](#) [NLV74HC14ADR2G](#) [NLV74HC20ADR2G](#)
[NLVVHC1G09DFT1G](#) [NLX2G86MUTCG](#) [74LVC2G32RA3-7](#) [74LVC2G00HD4-7](#) [NL17SG02P5T5G](#) [74LVC2G86HK3-7](#)
[NLV7SZ97DFT2G](#) [NLVVHC1G14DFT2G](#) [NLX1G99DMUTWG](#) [NLVVHC1G00DFT2G](#) [NLV7SZ57DFT2G](#) [NLV74VHC04DTR2G](#)
[NLV27WZ00USG](#) [NLU1G86CMUTCG](#) [NLU1G08CMUTCG](#) [NL17SZ32P5T5G](#) [NL17SZ00P5T5G](#) [NL17SH02P5T5G](#) [74AUP2G00RA3-7](#)
[NLVVHC1GT00DFT2G](#) [NLV74HC02ADTR2G](#) [NLX1G332CMUTCG](#) [NLVHCT132ADTR2G](#) [NL17SG86P5T5G](#) [NL17SZ05P5T5G](#)
[NLV74VHC00DTR2G](#) [NLVVHC1G02DFT1G](#) [NLV74HC86ADR2G](#)