



AiP74LV1T125

Single Supply Translating Buffer/Line Driver; 3-state

Product Specification

Specification Revision History:

Version	Date	Description
2017-06-A1	2017-06	New
2021-09-A2	2021-09	Modify ambient temperature to -40°C~+105°C and add electrical characteristics of -40°C~+105°C
2021-10-A3	2021-10	Modify Ordering Information
2021-12-A4	2021-12	Modify Ordering Information



1、 General Description

The AiP74LV1T125 is a single, level translating buffer/line driver with 3-state output. The low threshold inputs support 1.8V input logic at $V_{CC}=3.3V$ and can be used in 1.8V to 3.3V level up translation. In addition, the 5V tolerant input pins enable down translation (3.3V to 2.5V output at $V_{CC}=2.5V$). The 3-state output is controlled by the output enable input (\overline{OE}). A HIGH-level at \overline{OE} causes the output to assume a high-impedance OFF-state. The output level is referenced to the supply voltage and supports 1.8V, 2.5V, 3.3V and 5.0V CMOS levels. The wide V_{CC} range permits the generation of output levels to connect to controllers or processors.

Features:

- Single supply voltage translator at 1.8V, 2.5V, 3.3V and 5.0V
- Up translation
 - 1.2V to 1.8V at $V_{CC}=1.8V$
 - 1.5V to 2.5V at $V_{CC}=2.5V$
 - 1.8V to 3.3V at $V_{CC}=3.3V$
 - 3.3V to 5.0V at $V_{CC}=5.0V$
- Down translation
 - 3.3V to 1.8V at $V_{CC}=1.8V$
 - 3.3V to 2.5V at $V_{CC}=2.5V$
 - 5.0V to 3.3V at $V_{CC}=3.3V$
- 5V tolerant inputs
- Specified from $-40^{\circ}C$ to $+105^{\circ}C$
- Packaging information: SOT23-5/SOT353

**Ordering Information:****Reel packing specifications:**

Part number	Packaging form	Marking code	Reel quantity	Boxed reel quantity	Notes
AiP74LV1T125GB235.TR	SOT23-5	CJXX	3000 PCS/reel	30000 PCS/box	Dimensions of plastic enclosure: 2.9mm×1.6mm Pin spacing:0.95mm
AiP74LV1T125GC353.TR	SOT353	CJXX	3000 PCS/reel	30000 PCS/box	Dimensions of plastic enclosure: 2.1mm×1.3mm Pin spacing:0.65mm

Note: "XX" refers to variable content, meaning year and month.

If the physical information is inconsistent with the ordering information, please refer to the actual product.



2、Block Diagram And Pin Description

2.1、Block Diagram

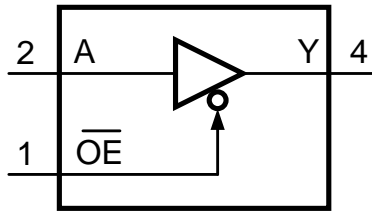

Figure 1. Logic symbol

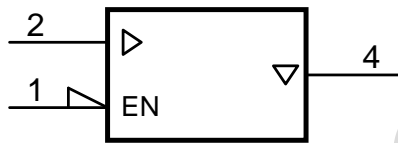

Figure 2. IEC logic symbol

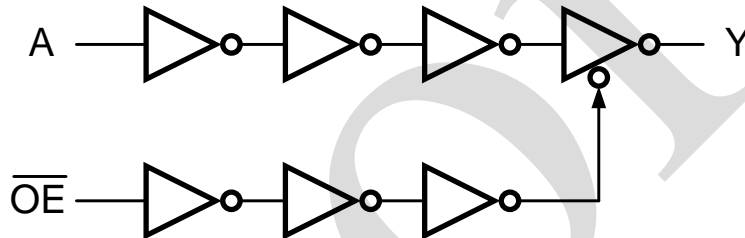
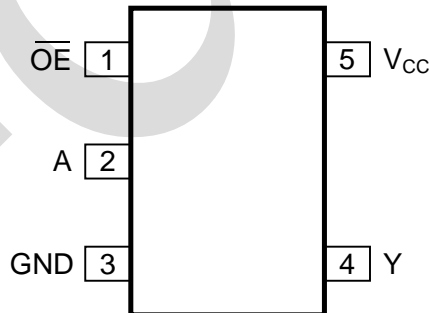

Figure 3. Logic diagram

2.2、Pin Configurations



2.3、Pin Description

Pin No.	Pin Name	Description
1	$\overline{\text{OE}}$	output enable input
2	A	data input
3	GND	ground (0 V)
4	Y	data output
5	V _{CC}	supply voltage



2.4、Function Table

Input		Output
\overline{OE}	A	Y
L	L	L
L	H	H
H	X	Z

Note: H=HIGH voltage level; L=LOW voltage level; X=don't care; Z=high-impedance OFF-state.

3、Electrical Parameter

3.1、Absolute Maximum Ratings

(Voltages are referenced to GND (ground=0V), unless otherwise specified)

Characteristic	Symbol	Conditions	Min.	Max.	Unit
supply voltage	V_{CC}	-	-0.5	+7.0	V
input voltage	V_I	-	-0.5	+7.0	V
output voltage	V_O	output HIGH or LOW state	-0.5	$V_{CC}+0.5$	V
		output in 3-state or power-off state	-0.5	4.6	V
input clamping current	I_{IK}	$V_I < 0V$	-20	-	mA
output clamping current	I_{OK}	$V_O < 0V$ or $V_O > V_{CC}$	-	± 20	mA
output current	I_O	$V_O = 0V$ to V_{CC}	-	± 25	mA
supply current	I_{CC}	-	-	50	mA
ground current	I_{GND}	-	-50	-	mA
storage temperature	T_{stg}	-	-65	+150	$^{\circ}C$
total power dissipation	P_{tot}	$T_{amb} = -40^{\circ}C$ to $+105^{\circ}C$	-	250	mW
soldering temperature	T_L	10s	250		$^{\circ}C$

3.2、Recommended Operating Conditions

(Voltages are referenced to GND (ground=0V), unless otherwise specified)

Parameter	Symbol	Conditions	Min.	Typ.	Max.	Unit
supply voltage	V_{CC}	-	1.6	5.0	5.5	V
input voltage	V_I	-	0	-	5.5	V
output voltage	V_O	output HIGH or LOW state	0	-	V_{CC}	V
ambient temperature	T_{amb}	-	-40	-	+105	$^{\circ}C$
input transition rise and fall rate	$\Delta t/\Delta V$	$V_{CC} = 1.8V$ to $5.0V$	-	-	20	ns/V



3.3、Electrical Characteristics

3.3.1、DC Characteristics 1

($T_{amb}=25^{\circ}C$, voltages are referenced to GND (ground=0V), unless otherwise specified)

Parameter	Symbol	Conditions	Min.	Typ.	Max.	Unit	
HIGH-level input voltage	V_{IH}	$V_{CC}=1.65V$ to $1.8V$	0.94	-	-	V	
		$V_{CC}=2.0V$	0.99	-	-	V	
		$V_{CC}=2.25V$ to $2.5V$	1.135	-	-	V	
		$V_{CC}=2.75V$	1.21	-	-	V	
		$V_{CC}=3.0V$ to $3.3V$	1.35	-	-	V	
		$V_{CC}=3.6V$	1.47	-	-	V	
		$V_{CC}=4.5V$ to $5.0V$	2.02	-	-	V	
		$V_{CC}=5.5V$	2.10	-	-	V	
LOW-level input voltage	V_{IL}	$V_{CC}=1.65V$ to $2.0V$	-	-	0.58	V	
		$V_{CC}=2.25V$ to $2.75V$	-	-	0.75	V	
		$V_{CC}=3.0V$ to $3.6V$	-	-	0.80	V	
		$V_{CC}=4.5V$ to $5.5V$	-	-	0.80	V	
HIGH-level output voltage	V_{OH}	$V_I=V_{IH}$ or V_{IL}	$V_{CC}=1.65V$ to $5.5V$; $I_O=-20\mu A$	$V_{CC}-0.1$	-	-	V
			$V_{CC}=1.65V$; $I_O=-2mA$	1.28	-	-	V
			$V_{CC}=1.8V$; $I_O=-2mA$	1.5	-	-	V
			$V_{CC}=2.3V$; $I_O=-2.3mA$	2.0	-	-	V
			$V_{CC}=2.3V$; $I_O=-3mA$	2.0	-	-	V
			$V_{CC}=2.5V$; $I_O=-3mA$	2.25	-	-	V
			$V_{CC}=3.0V$; $I_O=-3mA$	2.78	-	-	V
			$V_{CC}=3.0V$; $I_O=-5.5mA$	2.6	-	-	V
			$V_{CC}=3.3V$; $I_O=-5.5mA$	2.9	-	-	V
			$V_{CC}=4.5V$; $I_O=-4mA$	4.2	-	-	V
			$V_{CC}=4.5V$; $I_O=-8mA$	4.1	-	-	V
LOW-level output voltage	V_{OL}	$V_I=V_{IH}$ or V_{IL}	$V_{CC}=1.65V$ to $5.5V$; $I_O=20\mu A$	-	-	0.1	V
			$V_{CC}=1.65V$; $I_O=2mA$	-	-	0.2	V
			$V_{CC}=2.3V$; $I_O=2.3mA$	-	-	0.1	V
			$V_{CC}=2.3V$; $I_O=3mA$	-	-	0.15	V
			$V_{CC}=3.0V$; $I_O=3mA$	-	-	0.1	V
			$V_{CC}=3.0V$; $I_O=5.5mA$	-	-	0.2	V
			$V_{CC}=4.5V$; $I_O=4mA$	-	-	0.15	V
			$V_{CC}=4.5V$; $I_O=8mA$	-	-	0.3	V
input leakage current	I_I	$V_I=V_{CC}$ or GND; $V_{CC}=0V$ to $5.5V$	-	-	± 0.1	μA	
OFF-state output current	I_{OZ}	-	-	-	± 0.25	μA	
supply current	I_{CC}	$V_I=V_{CC}$ or GND; $I_O=0A$; $V_{CC}=1.8V, 2.5V, 3.3V, 5.0V$	-	-	1	μA	



Additional supply current	ΔI_{CC}	per input pin; $V_{CC}=1.8V$; $V_I=0.3V$ or $1.1V$; $I_O=0A$; other pins at V_{CC} or GND	-	-	10	μA
		per input pin; $V_{CC}=5.5V$; $V_I=0.3V$ or $3.4V$; $I_O=0A$; other pins at V_{CC} or GND	-	-	1.35	mA

3.3.2、DC Characteristics 2

($T_{amb}=-40^{\circ}C$ to $+85^{\circ}C$, voltages are referenced to GND (ground=0V), unless otherwise specified)

Parameter	Symbol	Conditions	Min.	Typ.	Max.	Unit	
HIGH-level input voltage	V_{IH}	$V_{CC}=1.65V$ to $1.8V$	1.0	-	-	V	
		$V_{CC}=2.0V$	1.03	-	-	V	
		$V_{CC}=2.25V$ to $2.5V$	1.18	-	-	V	
		$V_{CC}=2.75V$	1.23	-	-	V	
		$V_{CC}=3.0V$ to $3.3V$	1.37	-	-	V	
		$V_{CC}=3.6V$	1.48	-	-	V	
		$V_{CC}=4.5V$ to $5.0V$	2.03	-	-	V	
		$V_{CC}=5.5V$	2.11	-	-	V	
LOW-level input voltage	V_{IL}	$V_{CC}=1.65V$ to $2.0V$	-	-	0.55	V	
		$V_{CC}=2.25V$ to $2.75V$	-	-	0.71	V	
		$V_{CC}=3.0V$ to $3.6V$	-	-	0.65	V	
		$V_{CC}=4.5V$ to $5.5V$	-	-	0.80	V	
HIGH-level output voltage	V_{OH}	$V_I=V_{IH}$ or V_{IL}	$V_{CC}=1.65V$ to $5.5V$; $I_O=-20\mu A$	$V_{CC}-0.1$	-	-	V
			$V_{CC}=1.65V$; $I_O=-2mA$	1.21	-	-	V
			$V_{CC}=1.8V$; $I_O=-2mA$	1.45	-	-	V
			$V_{CC}=2.3V$; $I_O=-2.3mA$	2.0	-	-	V
			$V_{CC}=2.3V$; $I_O=-3mA$	1.93	-	-	V
			$V_{CC}=2.5V$; $I_O=-3mA$	2.15	-	-	V
			$V_{CC}=3.0V$; $I_O=-3mA$	2.7	-	-	V
			$V_{CC}=3.0V$; $I_O=-5.5mA$	2.49	-	-	V
			$V_{CC}=3.3V$; $I_O=-5.5mA$	2.8	-	-	V
			$V_{CC}=4.5V$; $I_O=-4mA$	4.1	-	-	V
			$V_{CC}=4.5V$; $I_O=-8mA$	3.95	-	-	V
LOW-level output voltage	V_{OL}	$V_I=V_{IH}$ or V_{IL}	$V_{CC}=1.65V$ to $5.5V$; $I_O=20\mu A$	-	-	0.1	V
			$V_{CC}=1.65V$; $I_O=2mA$	-	-	0.25	V
			$V_{CC}=2.3V$; $I_O=2.3mA$	-	-	0.15	V
			$V_{CC}=2.3V$; $I_O=3mA$	-	-	0.2	V
			$V_{CC}=3.0V$; $I_O=3mA$	-	-	0.15	V
			$V_{CC}=3.0V$; $I_O=5.5mA$	-	-	0.252	V
			$V_{CC}=4.5V$; $I_O=4mA$	-	-	0.2	V
			$V_{CC}=4.5V$; $I_O=8mA$	-	-	0.35	V
input leakage current	I_I	$V_I=V_{CC}$ or GND; $V_{CC}=0V$ to $5.5V$	-	-	± 1	μA	



OFF-state output current	I_{OZ}	-	-	-	± 2.5	μA
supply current	I_{CC}	$V_I = V_{CC}$ or GND; $I_O = 0A$; $V_{CC} = 1.8V, 2.5V, 3.3V, 5.0V$	-	-	10	μA
Additional supply current	ΔI_{CC}	per input pin; $V_{CC} = 1.8V$; $V_I = 0.3V$ or $1.1V$; $I_O = 0A$; other pins at V_{CC} or GND	-	-	10	μA
		per input pin; $V_{CC} = 5.5V$; $V_I = 0.3V$ or $3.4V$; $I_O = 0A$; other pins at V_{CC} or GND	-	-	1.5	mA

3.3.3、DC Characteristics 3

($T_{amb} = -40^{\circ}C$ to $+105^{\circ}C$, voltages are referenced to GND (ground=0V), unless otherwise specified)

Parameter	Symbol	Conditions	Min.	Typ.	Max.	Unit	
HIGH-level input voltage	V_{IH}	$V_{CC} = 1.65V$ to $1.8V$	1.0	-	-	V	
		$V_{CC} = 2.0V$	1.03	-	-	V	
		$V_{CC} = 2.25V$ to $2.5V$	1.18	-	-	V	
		$V_{CC} = 2.75V$	1.23	-	-	V	
		$V_{CC} = 3.0V$ to $3.3V$	1.37	-	-	V	
		$V_{CC} = 3.6V$	1.48	-	-	V	
		$V_{CC} = 4.5V$ to $5.0V$	2.03	-	-	V	
LOW-level input voltage	V_{IL}	$V_{CC} = 1.65V$ to $2.0V$	-	-	0.55	V	
		$V_{CC} = 2.25V$ to $2.75V$	-	-	0.71	V	
		$V_{CC} = 3.0V$ to $3.6V$	-	-	0.65	V	
		$V_{CC} = 4.5V$ to $5.5V$	-	-	0.80	V	
HIGH-level output voltage	V_{OH}	$V_I = V_{IH}$ or V_{IL}	$V_{CC} = 1.65V$ to $5.5V$; $I_O = -20\mu A$	$V_{CC} - 0.1$	-	-	V
			$V_{CC} = 1.65V$; $I_O = -2mA$	1.21	-	-	V
			$V_{CC} = 1.8V$; $I_O = -2mA$	1.45	-	-	V
			$V_{CC} = 2.3V$; $I_O = -2.3mA$	2.0	-	-	V
			$V_{CC} = 2.3V$; $I_O = -3mA$	1.93	-	-	V
			$V_{CC} = 2.5V$; $I_O = -3mA$	2.15	-	-	V
			$V_{CC} = 3.0V$; $I_O = -3mA$	2.7	-	-	V
			$V_{CC} = 3.0V$; $I_O = -5.5mA$	2.49	-	-	V
			$V_{CC} = 3.3V$; $I_O = -5.5mA$	2.8	-	-	V
			$V_{CC} = 4.5V$; $I_O = -4mA$	4.1	-	-	V
			$V_{CC} = 4.5V$; $I_O = -8mA$	3.95	-	-	V
LOW-level output voltage	V_{OL}	$V_I = V_{IH}$ or V_{IL}	$V_{CC} = 1.65V$ to $5.5V$; $I_O = 20\mu A$	-	-	0.1	V
			$V_{CC} = 1.65V$; $I_O = 2mA$	-	-	0.25	V
			$V_{CC} = 2.3V$; $I_O = 2.3mA$	-	-	0.15	V
			$V_{CC} = 2.3V$; $I_O = 3mA$	-	-	0.2	V
			$V_{CC} = 3.0V$; $I_O = 3mA$	-	-	0.15	V
			$V_{CC} = 3.0V$; $I_O = 5.5mA$	-	-	0.252	V



			$V_{CC}=4.5V; I_O=4mA$	-	-	0.2	V
			$V_{CC}=4.5V; I_O=8mA$	-	-	0.35	V
input leakage current	I_I	$V_I=V_{CC}$ or GND; $V_{CC}=0V$ to 5.5V		-	-	± 1	μA
OFF-state output current	I_{OZ}	-		-	-	± 2.5	μA
supply current	I_{CC}	$V_I=V_{CC}$ or GND; $I_O=0A$; $V_{CC}=1.8V, 2.5V, 3.3V, 5.0V$		-	-	10	μA
Additional supply current	ΔI_{CC}	per input pin; $V_{CC}=1.8V$; $V_I=0.3V$ or 1.1V; $I_O=0A$; other pins at V_{CC} or GND		-	-	10	μA
		per input pin; $V_{CC}=5.5V$; $V_I=0.3V$ or 3.4V; $I_O=0A$; other pins at V_{CC} or GND		-	-	1.5	mA

3.3.4、AC Characteristics 1

($T_{amb}=25^{\circ}C$, GND=0V, unless otherwise specified)

Parameter	Symbol	Conditions	Min.	Typ.	Max.	Unit	
propagation delay	t_{pd}	A to Y; see Figure 5 ^[1]	$V_{CC}=1.8V; C_L=15pF$	-	6.5	9.6	ns
			$V_{CC}=1.8V; C_L=30pF$	-	7.6	10.8	ns
			$V_{CC}=2.5V; C_L=15pF$	-	4.6	6.6	ns
			$V_{CC}=2.5V; C_L=30pF$	-	5.3	7.4	ns
			$V_{CC}=3.3V; C_L=15pF$	-	3.8	5.4	ns
			$V_{CC}=3.3V; C_L=30pF$	-	4.4	6.0	ns
			$V_{CC}=5.0V; C_L=15pF$	-	3.2	4.1	ns
			$V_{CC}=5.0V; C_L=30pF$	-	3.6	4.6	ns
enable time	t_{en}	\overline{OE} to Y; see Figure 6 ^[1]	$V_{CC}=1.8V; C_L=15pF$	-	7.8	10.7	ns
			$V_{CC}=1.8V; C_L=30pF$	-	9.0	12.6	ns
			$V_{CC}=2.5V; C_L=15pF$	-	5.5	7.1	ns
			$V_{CC}=2.5V; C_L=30pF$	-	6.3	8.3	ns
			$V_{CC}=3.3V; C_L=15pF$	-	4.5	5.6	ns
			$V_{CC}=3.3V; C_L=30pF$	-	5.1	6.4	ns
			$V_{CC}=5.0V; C_L=15pF$	-	3.2	4.1	ns
			$V_{CC}=5.0V; C_L=30pF$	-	3.7	4.7	ns
disable time	t_{dis}	\overline{OE} to Y; see Figure 6 ^[1]	$V_{CC}=1.8V; C_L=15pF$	-	7.6	9.7	ns
			$V_{CC}=1.8V; C_L=30pF$	-	10.5	12.9	ns
			$V_{CC}=2.5V; C_L=15pF$	-	5.5	7.0	ns
			$V_{CC}=2.5V; C_L=30pF$	-	7.4	9.0	ns
			$V_{CC}=3.3V; C_L=15pF$	-	4.5	5.8	ns
			$V_{CC}=3.3V; C_L=30pF$	-	5.9	7.5	ns
			$V_{CC}=5.0V; C_L=15pF$	-	4.0	5.5	ns
			$V_{CC}=5.0V; C_L=30pF$	-	5.0	6.5	ns
input capacitance	C_I	$V_I=V_{CC}$ or GND; $V_{CC}=3.3V$		-	1.5	10	pF



output capacitance	C_O	$V_O=V_{CC}$ or GND; $V_{CC}=3.3V$	-	2.5	-	pF	
power dissipation capacitance	C_{PD}	per buffer; $V_I=GND$ to V_{CC} ; $C_L=30$ pF; $f=10MHz$ ^[2]	$V_{CC}=1.8V$	-	4.1	-	pF
			$V_{CC}=2.5V$	-	5.3	-	pF
			$V_{CC}=3.3V$	-	6.9	-	pF
			$V_{CC}=5.0V$	-	10.7	-	pF

Note:

[1] t_{pd} is the same as t_{PLH} and t_{PHL} , t_{en} is the same as t_{PZL} and t_{PZH} , t_{dis} is the same as t_{PLZ} and t_{PHZ} .

[2] C_{PD} is used to determine the dynamic power dissipation (P_D in uW).

$P_D=C_{PD} \times V_{CC}^2 \times f_i \times N + \Sigma(C_L \times V_{CC}^2 \times f_o)$ where:

f_i =input frequency in MHz;

f_o =output frequency in MHz;

C_L =output load capacitance in pF;

V_{CC} =supply voltage in V;

N =number of inputs switching;

$\Sigma(C_L \times V_{CC}^2 \times f_o)$ =sum of the outputs.

3.3.5、AC Characteristics 2

($T_{amb}=-40^\circ C$ to $+85^\circ C$, GND=0V, unless otherwise specified)

Parameter	Symbol	Conditions	Min.	Typ.	Max.	Unit	
propagation delay	t_{pd}	A to Y; see Figure 5 ^[1]	$V_{CC}=1.8V$; $C_L=15pF$	-	-	10.8	ns
			$V_{CC}=1.8V$; $C_L=30pF$	-	-	12.2	ns
			$V_{CC}=2.5V$; $C_L=15pF$	-	-	7.5	ns
			$V_{CC}=2.5V$; $C_L=30pF$	-	-	8.4	ns
			$V_{CC}=3.3V$; $C_L=15pF$	-	-	6.0	ns
			$V_{CC}=3.3V$; $C_L=30pF$	-	-	6.8	ns
			$V_{CC}=5.0V$; $C_L=15pF$	-	-	4.4	ns
			$V_{CC}=5.0V$; $C_L=30pF$	-	-	5.1	ns
enable time	t_{en}	\overline{OE} to Y; see Figure 6 ^[1]	$V_{CC}=1.8V$; $C_L=15pF$	-	-	12.1	ns
			$V_{CC}=1.8V$; $C_L=30pF$	-	-	14.3	ns
			$V_{CC}=2.5V$; $C_L=15pF$	-	-	8.0	ns
			$V_{CC}=2.5V$; $C_L=30pF$	-	-	9.3	ns
			$V_{CC}=3.3V$; $C_L=15pF$	-	-	6.3	ns
			$V_{CC}=3.3V$; $C_L=30pF$	-	-	7.2	ns
			$V_{CC}=5.0V$; $C_L=15pF$	-	-	4.6	ns
			$V_{CC}=5.0V$; $C_L=30pF$	-	-	5.3	ns
disable time	t_{dis}	\overline{OE} to Y; see Figure 6 ^[1]	$V_{CC}=1.8V$; $C_L=15pF$	-	-	10.7	ns
			$V_{CC}=1.8V$; $C_L=30pF$	-	-	14.0	ns
			$V_{CC}=2.5V$; $C_L=15pF$	-	-	7.7	ns
			$V_{CC}=2.5V$; $C_L=30pF$	-	-	10.0	ns
			$V_{CC}=3.3V$; $C_L=15pF$	-	-	6.4	ns
			$V_{CC}=3.3V$; $C_L=30pF$	-	-	8.1	ns
			$V_{CC}=5.0V$; $C_L=15pF$	-	-	5.9	ns
			$V_{CC}=5.0V$; $C_L=30pF$	-	-	6.9	ns
input capacitance	C_I	$V_I=V_{CC}$ or GND; $V_{CC}=3.3V$	-	-	10	pF	



Note:

[1] t_{pd} is the same as t_{PLH} and t_{PHL} , t_{en} is the same as t_{PZL} and t_{PZH} , t_{dis} is the same as t_{PLZ} and t_{PHZ} .

3.3.6、 AC Characteristics 3

($T_{amb}=-40^{\circ}C$ to $+105^{\circ}C$, $GND=0V$, unless otherwise specified)

Parameter	Symbol	Conditions	Min.	Typ.	Max.	Unit	
propagation delay	t_{pd}	A to Y; see Figure 5 ^[1]	$V_{CC}=1.8V; C_L=15pF$	-	-	11.6	ns
			$V_{CC}=1.8V; C_L=30pF$	-	-	13.1	ns
			$V_{CC}=2.5V; C_L=15pF$	-	-	7.0	ns
			$V_{CC}=2.5V; C_L=30pF$	-	-	9.1	ns
			$V_{CC}=3.3V; C_L=15pF$	-	-	6.4	ns
			$V_{CC}=3.3V; C_L=30pF$	-	-	7.3	ns
			$V_{CC}=5.0V; C_L=15pF$	-	-	4.7	ns
			$V_{CC}=5.0V; C_L=30pF$	-	-	5.4	ns
enable time	t_{en}	\overline{OE} to Y; see Figure 6 ^[1]	$V_{CC}=1.8V; C_L=15pF$	-	-	12.9	ns
			$V_{CC}=1.8V; C_L=30pF$	-	-	15.3	ns
			$V_{CC}=2.5V; C_L=15pF$	-	-	8.6	ns
			$V_{CC}=2.5V; C_L=30pF$	-	-	10.0	ns
			$V_{CC}=3.3V; C_L=15pF$	-	-	6.8	ns
			$V_{CC}=3.3V; C_L=30pF$	-	-	7.7	ns
			$V_{CC}=5.0V; C_L=15pF$	-	-	4.8	ns
			$V_{CC}=5.0V; C_L=30pF$	-	-	5.5	ns
disable time	t_{dis}	\overline{OE} to Y; see Figure 6 ^[1]	$V_{CC}=1.8V; C_L=15pF$	-	-	11.3	ns
			$V_{CC}=1.8V; C_L=30pF$	-	-	14.7	ns
			$V_{CC}=2.5V; C_L=15pF$	-	-	8.1	ns
			$V_{CC}=2.5V; C_L=30pF$	-	-	10.3	ns
			$V_{CC}=3.3V; C_L=15pF$	-	-	6.7	ns
			$V_{CC}=3.3V; C_L=30pF$	-	-	8.6	ns
			$V_{CC}=5.0V; C_L=15pF$	-	-	6.2	ns
			$V_{CC}=5.0V; C_L=30pF$	-	-	7.3	ns
input capacitance	C_I	$V_I=V_{CC}$ or $GND; V_{CC}=3.3V$	-	-	10	pF	

Note:

[1] t_{pd} is the same as t_{PLH} and t_{PHL} , t_{en} is the same as t_{PZL} and t_{PZH} , t_{dis} is the same as t_{PLZ} and t_{PHZ} .



4、Testing Circuit

4.1、AC Testing Circuit

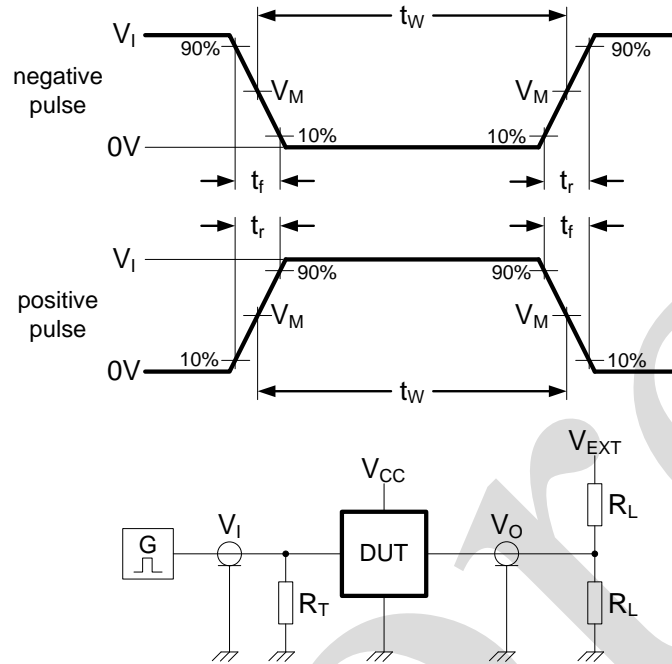

Figure 4. Test circuit for measuring switching times

Definitions test circuit:

R_T =Termination resistance should be equal to output impedance Z_o of the pulse generator

C_L =Load capacitance including jig and probe capacitance

R_L =Load resistance

V_{EXT} =External voltage for measuring switching times



4.2、 AC Testing Waveforms

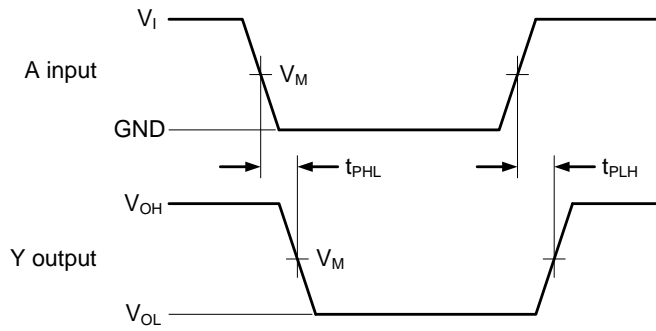

V_{OL} and V_{OH} are typical voltage output levels that occur with the output load.

Figure 5. The input A to output Y propagation delays

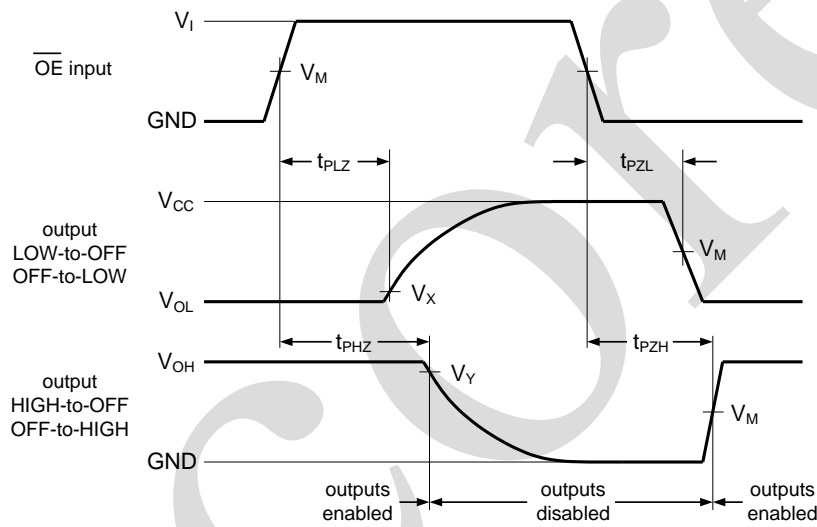

V_{OL} and V_{OH} are typical voltage output levels that occur with the output load.

Figure 6. 3-state enable and disable times

4.3、 Measurement Points

Input	Output		
V_M	V_M	V_X	V_Y
$0.5V_I$	$0.5V_{CC}$	$V_{OL}+0.3V$	$V_{OH}-0.3V$

4.4、 Test Data

Supply voltage	Input			Load		V_{EXT}		
V_{CC}	V_I	$\Delta t/\Delta V^{[1]}$	f_{max}	C_L	R_L	t_{PLH}, t_{PHL}	t_{PZH}, t_{PHZ}	t_{PZL}, t_{PLZ}
1.8V	V_{CC}	$\leq 1.0ns/V$	15MHz	15pF, 30pF	1k Ω	open	GND	V_{CC}
2.5V	V_{CC}	$\leq 1.0ns/V$	25MHz	15pF, 30pF	1k Ω	open	GND	V_{CC}
3.3V	3V	$\leq 1.0ns/V$	50MHz	15pF, 30pF	1k Ω	open	GND	V_{CC}
5.0V	3V	$\leq 1.0ns/V$	50MHz	15pF, 30pF	1k Ω	open	GND	V_{CC}

Note: [1] $dV/dt \geq 1.0V/ns$



5、 Package Information

5.1、 SOT23-5

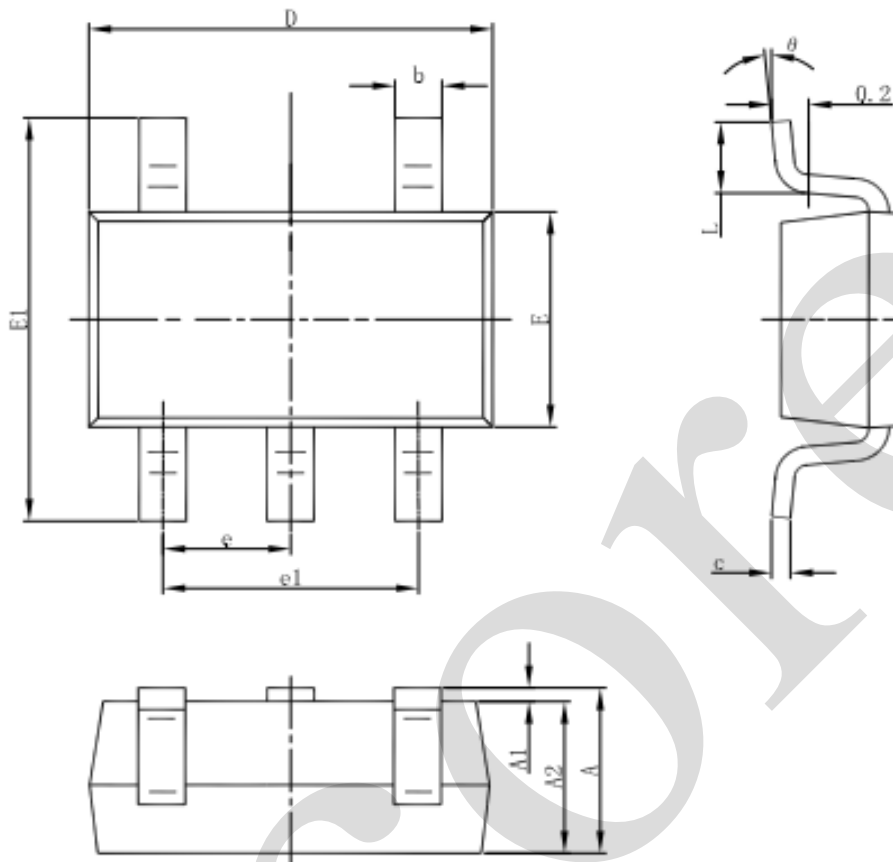

Symbol	Dimensions In Millimeters		Dimensions In Inches	
	Min	Max	Min	Max
A	1.050	1.250	0.041	0.049
A1	0.000	0.100	0.000	0.004
A2	1.050	1.150	0.041	0.045
b	0.300	0.500	0.012	0.020
c	0.100	0.200	0.004	0.008
D	2.820	3.020	0.111	0.119
E	1.500	1.700	0.059	0.067
E1	2.650	2.950	0.104	0.116
e	0.950(BSC)		0.037(BSC)	
e1	1.800	2.000	0.071	0.079
L	0.300	0.600	0.012	0.024
θ	0°	8°	0°	8°



5.2、SOT353

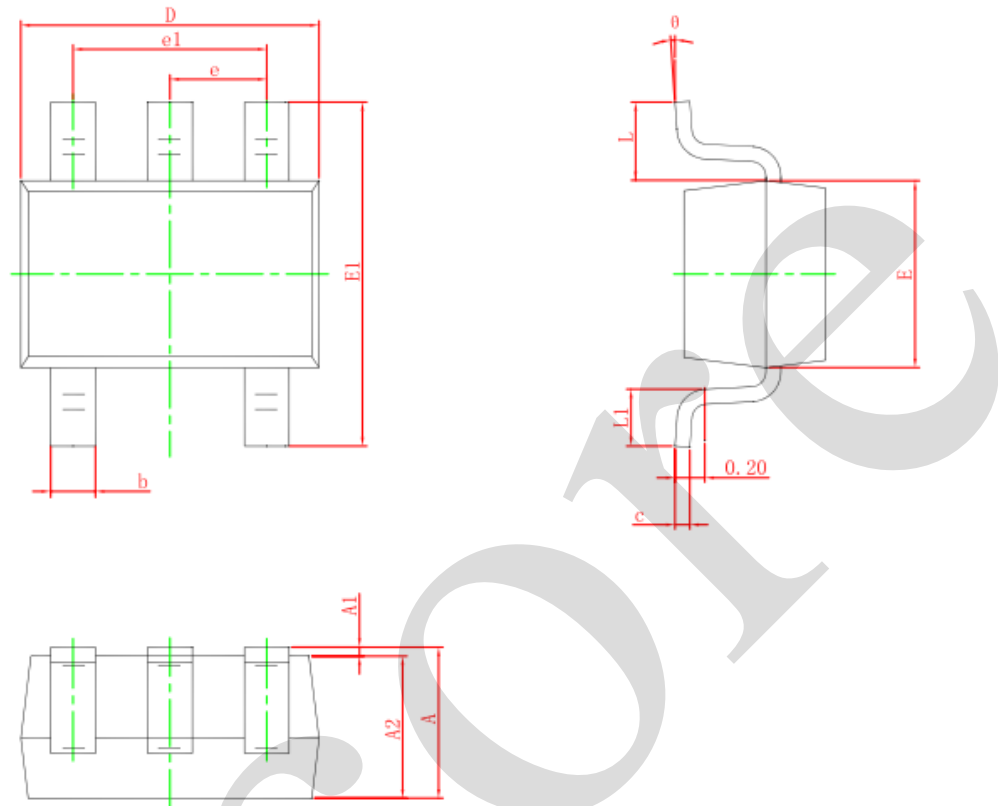

Symbol	Dimensions In Millimeters		Dimensions In Inches	
	Min.	Max.	Min.	Max.
A	0.900	1.100	0.035	0.043
A1	0.000	0.100	0.000	0.004
A2	0.900	1.000	0.035	0.039
b	0.150	0.350	0.006	0.014
c	0.080	0.150	0.003	0.006
D	2.000	2.200	0.079	0.087
E	1.150	1.350	0.045	0.053
E1	2.150	2.450	0.085	0.096
e	0.650 TYP.		0.026 TYP.	
e1	1.200	1.400	0.047	0.055
L	0.525 REF.		0.021 REF.	
L1	0.260	0.460	0.010	0.018
θ	0°	8°	0°	8°



6、 Statements And Notes

6.1、 The name and content of Hazardous substances or Elements in the product

Part name	Hazardous substances or Elements									
	Lead and lead compounds	Mercury and mercury compounds	Cadmium and cadmium compounds	Hexavalent chromium compounds	Polybrominated biphenyls	Polybrominated biphenyl ethers	Dibutyl phthalate	Butylbenzyl phthalate	Di-2-ethylhexyl phthalate	Diisobutyl phthalate
Lead frame	○	○	○	○	○	○	○	○	○	○
Plastic resin	○	○	○	○	○	○	○	○	○	○
Chip	○	○	○	○	○	○	○	○	○	○
The lead	○	○	○	○	○	○	○	○	○	○
Plastic sheet installed	○	○	○	○	○	○	○	○	○	○
explanation	○: Indicates that the content of hazardous substances or elements in the detection limit of the following the SJ/T11363-2006 standard. ×: Indicates that the content of hazardous substances or elements exceeding the SJ/T11363-2006 Standard limit requirements.									

6.2、 Notion

Recommended carefully reading this information before the use of this product;

The information in this document are subject to change without notice;

This information is using to the reference only, the company is not responsible for any loss;

The company is not responsible for the any infringement of the third party patents or other rights of the responsibility.

X-ON Electronics

Largest Supplier of Electrical and Electronic Components

Click to view similar products for [Buffers & Line Drivers](#) category:

Click to view products by [I-core](#) manufacturer:

Other Similar products are found below :

[LXV200-024SW](#) [74AUP2G34FW3-7](#) [HEF4043BP](#) [NL17SG125DFT2G](#) [NLU1GT126CMUTCG](#) [CD4041UBE](#) [54FCT240CTDB](#)
[74HCT540N](#) [DS14C88N](#) [070519XB](#) [NL17SZ07P5T5G](#) [74LVC2G17FW4-7](#) [CD4502BE](#) [5962-8982101PA](#) [61446R00](#) [NL17SH17P5T5G](#)
[NLV37WZ17USG](#) [74HCT126T14-13](#) [74VHC9126FT\(BJ\)](#) [RHRXH162244K1](#) [74AUP1G34FW5-7](#) [74AUP1G07FW5-7](#) [74LVC1G126FW4-7](#)
[74LVC2G126RA3-7](#) [74LVCE1G125FZ4-7](#) [54FCT240TLB](#) [NLX3G16DMUTCG](#) [NLX2G06AMUTCG](#) [LE87100NQCT](#) [LE87285NQC](#)
[LE87290YQC](#) [LE87290YQCT](#) [74AUP1G125FW5-7](#) [NLU2G16CMUTCG](#) [MC74LCX244MN2TWG](#) [NL17SG17P5T5G](#)
[NLV74HC125ADR2G](#) [NLVHCT245ADTR2G](#) [NLVVHC1G126DFT2G](#) [EL5623IRZ](#) [ISL15102AIRZ-T13](#) [ISL1539IRZ-T13](#)
[MC100EP17MNG](#) [MC74HCT365ADR2G](#) [MC74LCX244ADTR2G](#) [NL27WZ126US](#) [NL37WZ16US](#) [NLU1G07MUTCG](#) [NLU2G07MUTCG](#)
[NLX3G17BMX1TCG](#)