

## BAT54... SCHOTTKY DIODES

### FEATURES

Extremely Fast Switching Speed

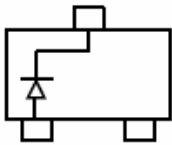
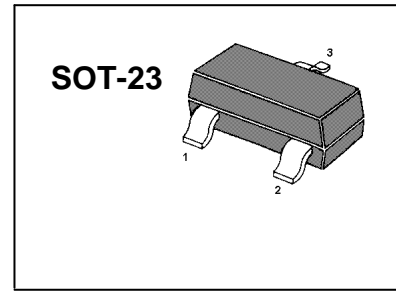

BAT54 MARKING: KL1

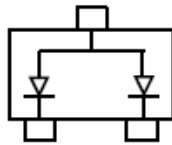

BAT54A MARKING: KL2

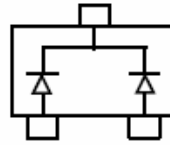

BAT54C MARKING: KL3

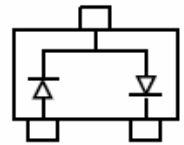

BAT54S MARKING: KL4

### Maximum Ratings @T<sub>A</sub>=25°C

Parameter	Symbol	Limits	Unit
Peak Repetitive Peak reverse voltage	V <sub>RRM</sub>	30	V
Working Peak Reverse Voltage	V <sub>RWM</sub>		
	V <sub>R</sub>		
Forward Continuous Current	I <sub>FM</sub>	200	mA
Power Dissipation	P <sub>D</sub>	200	mW
Storage temperature	T <sub>STG</sub>	-55-150	°C

### Electrical Characteristics @T<sub>A</sub>=25°C

Parameter	Symbol	Min.	Typ.	Max.	Unit	Conditions
Reverse Breakdown Voltage	V <sub>(BR)R</sub>	30			V	I <sub>R</sub> =100μA
Forward voltage	V <sub>F1</sub>			0.24	V	I <sub>F</sub> =0.1mA
	V <sub>F2</sub>			0.32	V	I <sub>F</sub> =1mA
	V <sub>F3</sub>			0.40	V	I <sub>F</sub> =10mA
	V <sub>F4</sub>			0.50	V	I <sub>F</sub> =30mA
	V <sub>F5</sub>			1	V	I <sub>F</sub> =100mA
Reverse current	I <sub>R</sub>			2	μA	V <sub>R</sub> =25V
Diode Capacitance	C <sub>D</sub>			10	pF	V <sub>R</sub> =1V, f=1MHz
Reverse Recovery Time	t <sub>rr</sub>			5	nS	I <sub>F</sub> =I <sub>R</sub> =10mA I <sub>rr</sub> =0.1X I <sub>R</sub> , R <sub>L</sub> =100Ω

电话: 0755-82568882      82568883

邮箱: [idchip@indreamchip.com](mailto:idchip@indreamchip.com)

传真: 0755-82568886

网址: [www.idchip.cn](http://www.idchip.cn)

公司地址: 深圳市福田区滨河大道联合广场 A 座 1308

## Typical Characteristics

## BAT54/A/C/S

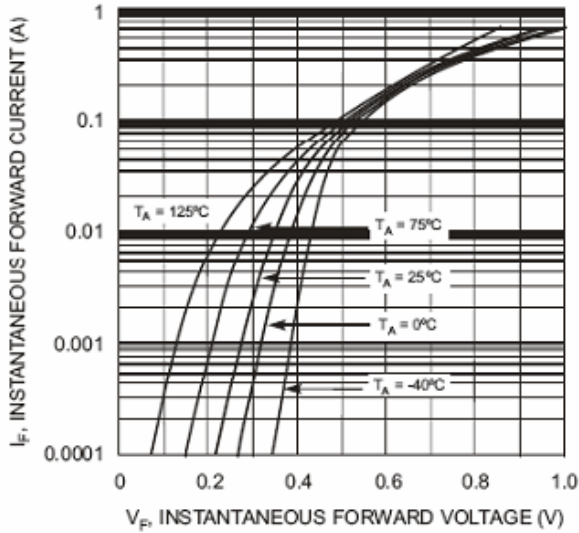

Fig. 1 Forward Characteristics

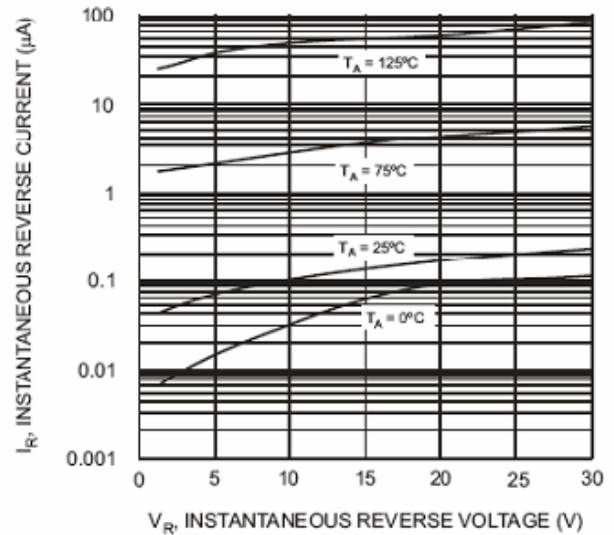

Fig. 2 Typical Reverse Characteristics

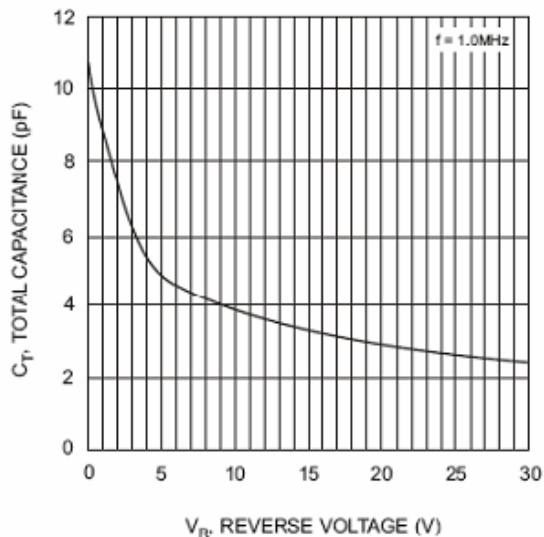

Fig. 3 Typical Capacitance vs. Reverse Voltage

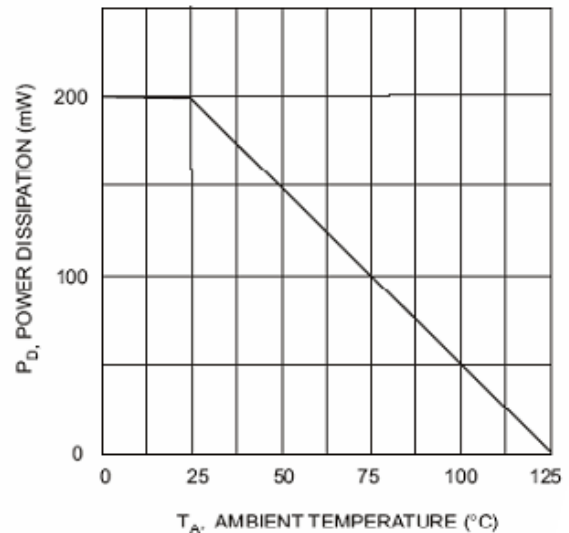

Fig. 4 Power Derating Curve

电话: 0755-82568882 82568883

传真: 0755-82568886

公司地址: 深圳市福田区滨河大道联合广场 A 座 1308

邮箱: [idchip@indreamchip.com](mailto:idchip@indreamchip.com)

网址: [www.idchip.cn](http://www.idchip.cn)

## PACKAGE OUTLINE

Plastic surface mounted package; 3 leads

SOT-23

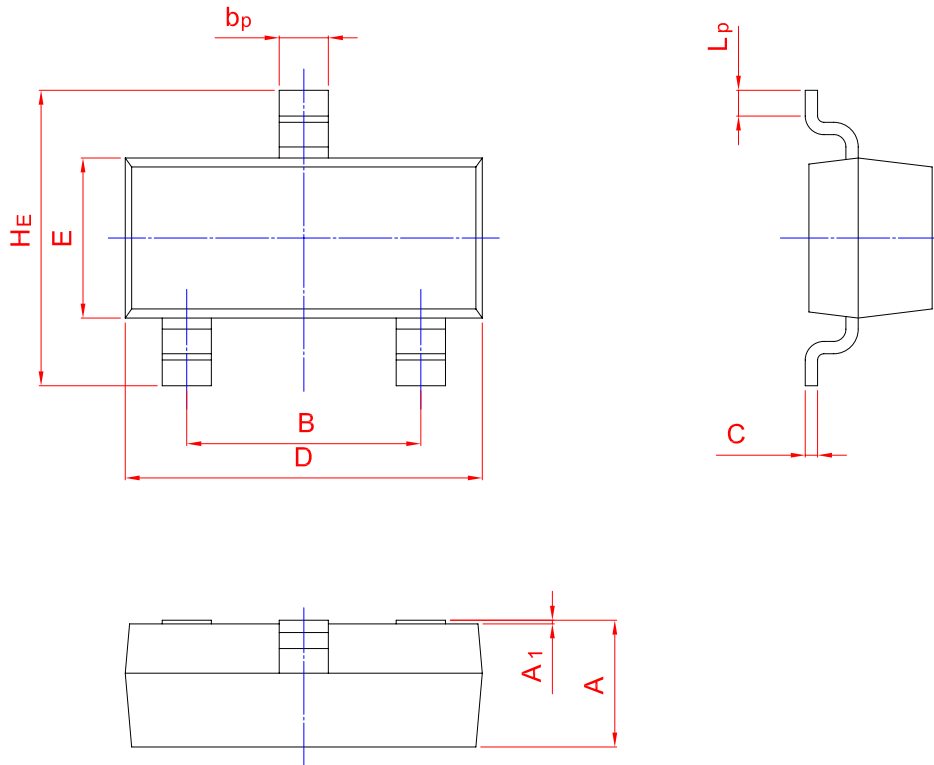
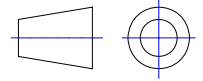

UNIT	A	B	b <sub>p</sub>	C	D	E	H <sub>E</sub>	A <sub>1</sub>	L <sub>p</sub>
mm	1.40	2.04	0.50	0.19	3.10	1.65	3.00	0.100	0.50
	0.95	1.78	0.35	0.08	2.70	1.20	2.20	0.013	0.20

电话: 0755-82568882 82568883

邮箱: [idchip@indreamchip.com](mailto:idchip@indreamchip.com)

传真: 0755-82568886

网址: [www.idchip.cn](http://www.idchip.cn)

公司地址: 深圳市福田区滨河大道联合广场 A 座 1308

## X-ON Electronics

Largest Supplier of Electrical and Electronic Components

*Click to view similar products for [Schottky Diodes & Rectifiers](#) category:*

*Click to view products by [IDCHIP](#) manufacturer:*

Other Similar products are found below :

[MA4E2039](#) [MA4E2508M-1112](#) [MBR10100CT-BP](#) [MBR1545CT](#) [MMBD301M3T5G](#) [GS1JE-TP](#) [RB160M-50TR](#) [BAS16E6433HTMA1](#)  
[BAS 3010S-02LRH E6327](#) [BAT 54-02LRH E6327](#) [NSR05F40QNXT5G](#) [NSVR05F40NXT5G](#) [NTE555](#) [JANS1N6640](#) [SB07-03C-TB-H](#)  
[SBS818-TL-E](#) [SK310-T](#) [SK33A-TP](#) [SK34B-TP](#) [SS3003CH-TL-E](#) [PDS3100Q-7](#) [GA01SHT18](#) [CRS10I30A\(TE85L,QM](#) [MA4E2501L-1290](#)  
[MBRB30H30CT-1G](#) [DMJ3940-000](#) [SB007-03C-TB-E](#) [SK32A-TP](#) [SK33B-TP](#) [SK35A-TP](#) [SK38B-LTP](#) [SK38B-TP](#) [NRVBM120LT1G](#)  
[NTE505](#) [NTSB30U100CT-1G](#) [SS0503SH-TL-E](#) [VS-6CWQ10FNHM3](#) [CRG04\(T5L,TEMQ\)](#) [ACDBA1100LR-HF](#) [ACDBA1200-HF](#)  
[ACDBA2100-HF](#) [ACDBA240-HF](#) [ACDBA3100-HF](#) [CDBQC0530L-HF](#) [ACDBA260LR-HF](#) [ACDBA1100-HF](#) [MA4E2502L-1246](#)  
[10BQ060-M3/5BT](#) [NRVB130LSFT1G](#) [CRS08TE85LQM](#)