

New TWND Series – Full Size NEMA Pushbuttons

**New! TWND Series: Heavy duty switches built to last****Key features:**

- Variety of button sizes up to 2 9/16" (65mm)
- Rugged construction includes chrome plated zinc locking ring die cast zinc mounting thread
- LED illumination
- Transformer or full voltage
- Slow make, double break wiping contacts
- Modular construction for maximum flexibility
- Available assembled or as sub-components
- UL Type 4X, 13 and IP65 watertight/oiltight panel

The rugged series of TWND switches offers both variety and durability in an attractive design.

With button sizes up to 2 9/16" (65mm), chrome plated zinc locking rings, die cast zinc mounting threads, steel anti-rotation rings, and self cleaning contacts, the TWNDs are here to stay.

The TWND series also offers LED illumination in full voltage and transformer models.

Regardless of your switching needs, the NEW TWND series provides the kind of long lasting, industrial strength quality you've come to expect from IDEC.



Switches & Pilot Devices

Signaling Lights

Relays & Sockets

Timers

Contactors

Terminal Blocks

Circuit Breakers

Specifications

| | |
|---|--|
| Conforming to Standards | EN60947-5-1, UL508, CSA C22-2 No.14 |
| Approvals | CSA: pushbuttons and selector switches: A600 pilot lights and illuminated pushbuttons, direct supply pilot lights and illuminated pushbuttons with integral transformer (100/110, 115, 120, 200/220, 230, 240, 380, 400/440, 480V) UL: pushbuttons and selector switches: A600 pilot lights and illuminated pushbuttons, direct supply pilot lights and illuminated pushbuttons with integral transformer (100/110, 115, 120, 200/220, 230, 240, 380, 400/440, 480V) TÜV: pushbuttons and selector switches: A600 pilot lights and illuminated pushbuttons, direct supply pilot lights and illuminated pushbuttons with integral transformer (100/110, 115, 120, 200/220, 230, 240, 380, 400/440, 480V) |
| Operating Temperature | Operation: -25 to +50°C (illuminated versions) -25 ~ +70C non-illuminated Storage: -40 to +80°C (without freezing) C-> °C |
| Vibration Resistance | 5 to 55Hz, 98m/sec ² (10g) conforming to IEC60068-2-6 |
| Shock Resistance | 980m/sec ² (100g) conforming to IEC60068-2-27 |
| Electric Shock Protection | Class 2 conforming to IEC60664-1 |
| Degree of Protection | IP65 (from front of the panel) (conforming to IEC60529) UL Type 1, 2, 3, 3R, 3S, 4, 4X, 5, 12, 13 (conforming to NEMA ICS6-110) |
| Mechanical Life | Momentary pushbuttons: 5,000,000 (1800 operations per hour) All other switches: 500,000 |
| Pollution Degree (conforming to IEC60947-1) | 3 |

Mechanical-Electrical Specifications

| | | | | | | |
|--|---|-------------------|--|------------------------------------|-------------------|------|
| Rated Operational Characteristics | AC-15: A600 | | | | | |
| Rated Insulation Voltage | 600V | | | | | |
| Rated Impulse Withstanding Voltage Dielectric Strength | Between live and dead metal parts 2.5kV AC, 1 minute | | | | | |
| Rated Thermal Current | 10 Amp | | | | | |
| Minimum Switching Capacity | 5 mA at 3V AC/DC (applicable range may vary with operating conditions and load types) | | | | | |
| Contact Operation | Slow break NC or NO | | | | | |
| Operating Force | Flush and extended pushbuttons—with 1NO or 1NC contact: 6.2±2N (momentary), 9.0±1.5N Additional contacts—1NO or 1NC: +3.0N | | | | | |
| Recommended Terminal Torque | Unit | Wire | Number of Wires | Recommended Tightening Torque (Nm) | Terminal Screw | |
| | HW-U Contact Block | Crimping Terminal | | 2 | 1.0 to 1.3 | M3.5 |
| | | Solid Wire | ø0.5 to 1.6 mm (AWG14 to 22) | 2 | 1.0 to 1.3 | |
| | | | ø1.7 to 2.0 mm (AWG12) | 1 | 1.2 to 1.3 | |
| | | Stranded Wire | 0.3 to 2.0 mm ² (AWG14 to 22) | 2 | 1.0 to 1.3 | |
| | 2.1 to 3.5 mm ² (AWG12) | | 1 | 1.2 to 1.3 | | |
| | Illuminated Unit (*1) | Crimping Terminal | | 2 | 1.0 to 1.3 | M3.5 |
| | | Solid Wire | ø0.5 to 1.6 mm (AWG14 to 22) | | | |
| Applicable Wire Size | Pilot Light | Crimping Terminal | | | 0.6 to 1.0 (M3.0) | |
| | | Solid Wire | ø0.5 to 1.6 mm (AWG14 to 22) | 2 | 1.0 to 1.3 (M3.5) | |
| | | Stranded Wire | ø0.3 to 2.0 mm (AWG14 to 22) | | | |
|  1. * refers to the lamp terminals of the illuminated push buttons and selector switches. | | | | | | |
| Contact Resistance | Initial contact resistance of 50mΩ or less | | | | | |
| Contact Gap | 4mm (NO and NC) 2mm (NO-EM and NC-LB) | | | | | |
| LED Ratings | LEDs: 6V: 8mA, 12V: 11mA, 24V: 11mA, 120V: 8.8mA, 240V: 8.6mA | | | | | |
| Contact Material | Silver | | | | | |

Contact Ratings

| | | | | | | | | |
|---|--------------|--|-----|-----|-----|------|------|------|
| Contact Ratings by Utilization Category IEC 60947-5-1 | AC-15 (A600) | | | | | | | |
| | DC-13 (P600) | | | | | | | |
| Contact Ratings by Utilization Category | | | | | | | | |
| Operational Voltage | | | 24V | 48V | 50V | 110V | 220V | 440V |
| Operation Current | AC 50/60 Hz | AC-12 Control of resistive loads & solid state loads | 10A | — | 10A | 10A | 6A | 2A |
| | | AC-15 Control of electromagnetic loads (> 72VA) | 10A | — | 7A | 5A | 3A | 1A |
| | DC | DC-12 Control of resistive loads & solid state loads | 10A | 5A | — | 2.2A | 1.1A | — |
| | | DC-13 Control of electromagnets | 5A | 2A | — | 1.1A | 0.6A | — |

Non-Illuminated Pushbuttons (Assembled)

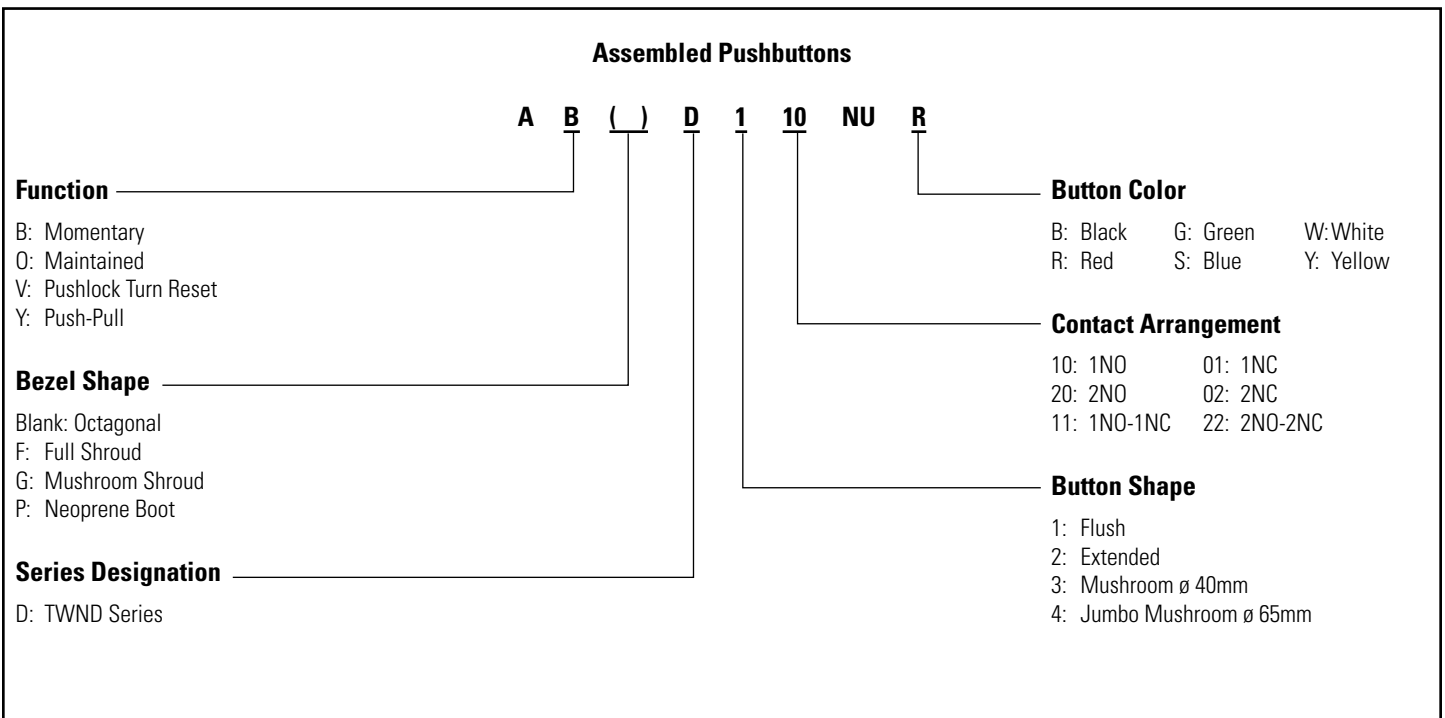

1. Use only when interpreting part numbers. Do not use for developing part numbers.
2. Custom contact configurations available, contact IDEC for details.

Non-Illuminated Pushbuttons (Assembled)

Non-Illuminated Pushbuttons

| Style | Contacts | Momentary | Maintained |
|--|----------|------------|------------|
| Flush | 1NO | ABD110NU⓪ | AOD110NU⓪ |
| | 1NC | ABD101NU⓪ | AOD101NU⓪ |
| | 1NO-1NC | ABD111NU⓪ | AOD111NU⓪ |
| | 2NO | ABD120NU⓪ | AOD120NU⓪ |
| | 2NC | ABD102NU⓪ | AOD102NU⓪ |
| Extended | 1NO | ABD210NU⓪ | AOD210NU⓪ |
| | 1NC | ABD201NU⓪ | AOD201NU⓪ |
| | 1NO-1NC | ABD211NU⓪ | AOD211NU⓪ |
| | 2NO | ABD220NU⓪ | AOD220NU⓪ |
| | 2NC | ABD202NU⓪ | AOD202NU⓪ |
| Extended with Neoprene Boot* | 1NO | ABPD210NU⓪ | AOPD210NU⓪ |
| | 1NC | ABPD201NU⓪ | AOPD201NU⓪ |
| | 1NO-1NC | ABPD211NU⓪ | AOPD211NU⓪ |
| | 2NO | ABPD220NU⓪ | AOPD220NU⓪ |
| | 2NC | ABPD202NU⓪ | AOPD202NU⓪ |
| Recessed | 1NO | ABFD110NU⓪ | AOFD110NU⓪ |
| | 1NC | ABFD101NU⓪ | AOFD101NU⓪ |
| | 1NO-1NC | ABFD111NU⓪ | AOFD111NU⓪ |
| | 2NO | ABFD120NU⓪ | AOFD120NU⓪ |
| | 2NC | ABFD102NU⓪ | AOFD102NU⓪ |
| Extended with Full Shroud | 1NO | ABFD210NU⓪ | AOFD210NU⓪ |
| | 1NC | ABFD201NU⓪ | AOFD201NU⓪ |
| | 1NO-1NC | ABFD211NU⓪ | AOFD211NU⓪ |
| | 2NO | ABFD220NU⓪ | AOFD220NU⓪ |
| | 2NC | ABFD202NU⓪ | AOFD202NU⓪ |
| ø 40mm Mushroom Head | 1NO | ABD310NU⓪ | AOD310NU⓪ |
| | 1NC | ABD301NU⓪ | AOD301NU⓪ |
| | 1NO-1NC | ABD311NU⓪ | AOD311NU⓪ |
| | 2NO | ABD320NU⓪ | AOD320NU⓪ |
| | 2NC | ABD302NU⓪ | AOD302NU⓪ |
| ø 40mm Mushroom Head with Full Shroud | 1NO | ABGD310NU⓪ | AOGD310NU⓪ |
| | 1NC | ABGD301NU⓪ | AOGD301NU⓪ |
| | 1NO-1NC | ABGD311NU⓪ | AOGD311NU⓪ |
| | 2NO | ABGD320NU⓪ | AOGD320NU⓪ |
| | 2NC | ABGD302NU⓪ | AOGD302NU⓪ |
| ø 65mm Jumbo Mushroom Head | 1NO | ABD410NU⓪ | AOD410NU⓪ |
| | 1NC | ABD401NU⓪ | AOD401NU⓪ |
| | 1NO-1NC | ABD411NU⓪ | AOD411NU⓪ |
| | 2NO | ABD420NU⓪ | AOD420NU⓪ |
| | 2NC | ABD402NU⓪ | AOD402NU⓪ |
| ø 65mm Jumbo Mushroom Head with Shallow Shroud | 1NO | ABGD410NU⓪ | AOGD410NU⓪ |
| | 1NC | ABGD401NU⓪ | AOGD401NU⓪ |
| | 1NO-1NC | ABGD411NU⓪ | AOGD411NU⓪ |
| | 2NO | ABGD420NU⓪ | AOGD420NU⓪ |
| | 2NC | ABGD402NU⓪ | AOGD402NU⓪ |
| ø 65mm Jumbo Mushroom Head With Deep Shroud | 1NO | ABFD410NU⓪ | AOFD410NU⓪ |
| | 1NC | ABFD401NU⓪ | AOFD401NU⓪ |
| | 1NO-1NC | ABFD411NU⓪ | AOFD411NU⓪ |
| | 2NO | ABFD420NU⓪ | AOFD420NU⓪ |
| | 2NC | ABFD402NU⓪ | AOFD402NU⓪ |

⓪ Button Color Codes

| Color | Code |
|--------|------|
| Black | B |
| Green | G |
| Red | R |
| Blue | S |
| Yellow | Y |
| White | W |



- 65mm Jumbo mushroom not available in white.
- Neoprene boot is not available in blue or white.



- In place of ⓪, specify the Button Color Code.
- For sub-assembly part numbers, see next page.
- *Neoprene boot available only in Black (B), Green (G), Red (R) and Yellow (Y).

Non-Illuminated Pushbuttons (Sub-Assembled)

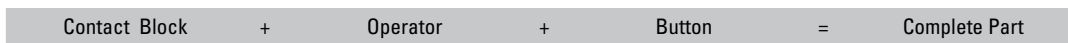

Operators

| Style | Image | Part Number | |
|---|-------|-------------|-------------|
| | | Momentary | Maintained |
| Flush/Extended | | ABD1200T8 | AOD1200T8 |
| Extended with Full Shroud | | ALFD2300T8 | AOLFD2300T8 |
| ø 40mm Mushroom/ø 65mm Jumbo Mushroom | | ABD3400T8 | AOD3400T8 |
| ø 40mm Mushroom with Full Shroud | | ABGD-300T | AOGD-300T |
| ø 65mm Jumbo Mushroom with Shallow Shroud | | ABGD-400T | AOGD-400T |
| ø 65mm Jumbo Mushroom with Deep Shroud | | ABFD-400T | AOFD-400T |

Buttons and Lenses

| Style | Image | Part Number |
|-----------------------|-------|-------------|
| Flush | | ABD1BN-Ⓢ |
| Extended | | ABD2BN-Ⓢ |
| ø 40mm Mushroom | | ABD3BN-Ⓢ |
| ø 65mm Jumbo Mushroom | | ABD4BN-Ⓢ |



In place of Ⓢ, specify the Button Color Code. (See table previous page)

Contact Blocks

| Style | Image | Part Number | |
|-------------------|-------|------------------------------------|------------------------------------|
| | | 1NO | 1NC |
| All Control Units | | HW-U10-F HW-U10R-F (early make) | HW-U01-F HW-U01R-F (late break) |
| Dummy Block | | HW-DB | |



- Dummy blocks (no contacts) are used with an odd number of contact blocks.
- Combining HW-U10R-F and HW-U01R-F result in overlapping contacts (remain on, or closed, when switch is moved between two positions).

Stop Switches (Assembled)

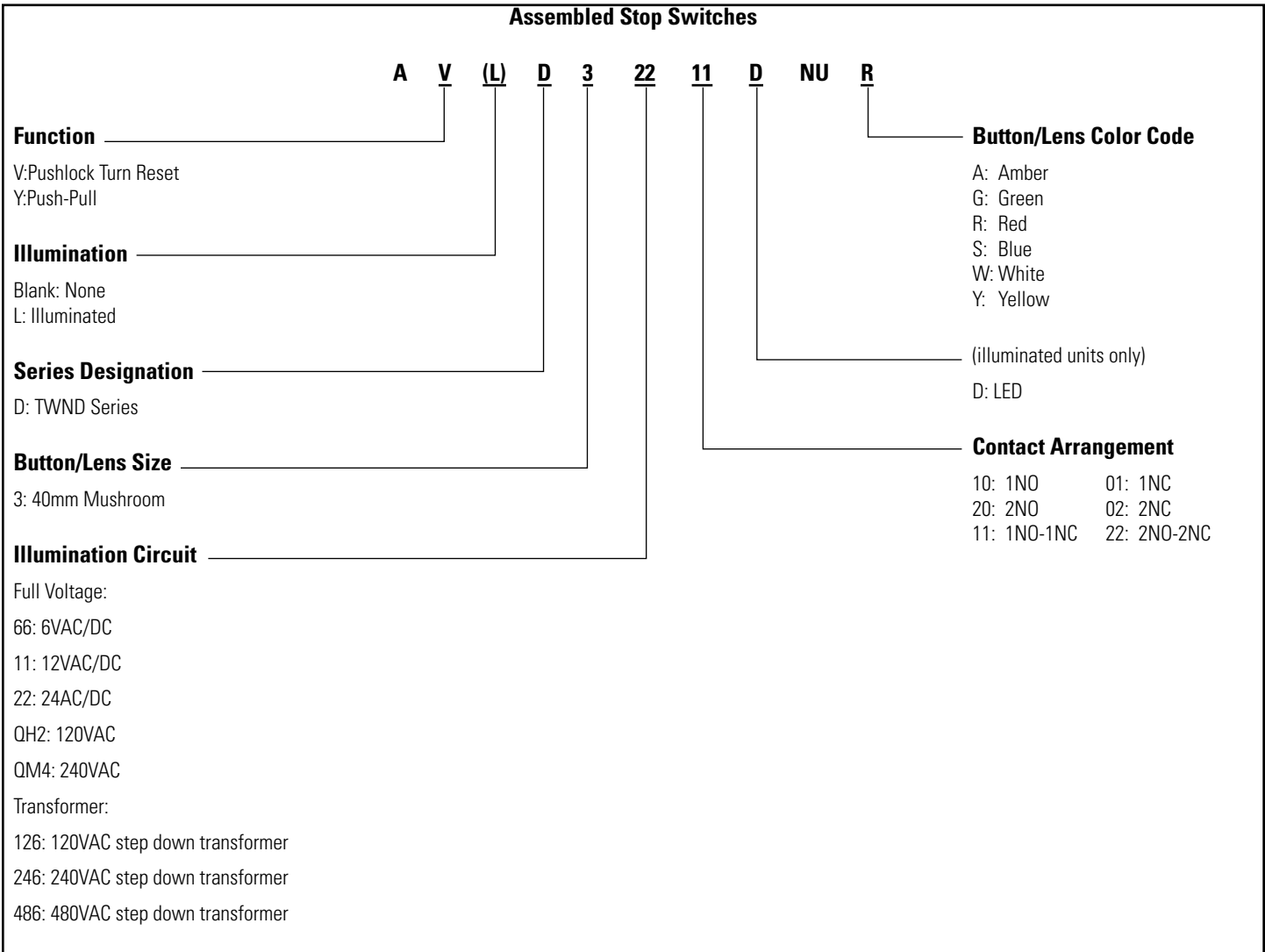

1. Use only when interpreting part numbers. Do not use for developing part numbers.
2. Custom contact configurations available, contact IDEC for details.

Stop Switches (Assembled)

Stop Switches

| Style | Contacts | Part Number |
|---|-----------------|--|
| ø 40mm Pushlock Turn Reset  | Non-Illuminated | 1NO AVD310NUR* 1NC AVD301NUR* 1NO-1NC AVD311NUR* 2NO AVD320NUR* 2NC AVD302NUR* |
| | Full Voltage | 1NO-1NC AVLD3③11DNUR* 2NO AVLD3③20DNUR* 2NC AVLD3③02DNUR* |
| ø 40mm Illuminated Pushlock Turn Reset  | Transformer | 1NO-1NC AVLD3④11DNUR* 2NO AVLD3④20DNUR* 2NC AVLD3④02DNUR* |
| | Non-Illuminated | 1NO AYD310NU⑤ 1NC AYD301NU⑤ 1NO-1NC AYD311NU⑤ 2NO AYD320NU⑤ 2NC AYD302NU⑤ |
| ø 40mm Push-Pull  | Full Voltage | 1NO-1NC AYLD3③11DNU② ** 2NO AYLD3③20DNU② ** 2NC AYLD3③02DNU② ** |
| | Transformer | 1NO-1NC AYLD3④11DNU② ** 2NO AYLD3④20DNU② ** 2NC AYLD3④02DNU② ** |

- 1. In place of ①, specify the button color code
- 2. In place of ②, specify the lens color code.
- 3. In place of ③, specify the Full Voltage (lamp voltage) Code.
- 4. * Only available in red.
- 5. In place of ④, specify the transformer voltage code.
- 6. **Not available in blue.
- 7. For sub-assembly part numbers, see next page.
- 8. For nameplates and accessories, see page 769 and page 767.
- 9. For dimensions, see page 772.

① Button Color Codes

| Color | Code |
|--------|------|
| Black | B |
| Green | G |
| Red | R |
| Blue | S |
| Yellow | Y |

② Lens Color Codes

| Color | Code |
|--------|------|
| Amber | A |
| Green | G |
| Red | R |
| Blue | S |
| White | W |
| Yellow | Y |

③ Full Voltage Codes

| Voltage | Code |
|-----------|------|
| 6V AC/DC | 66 |
| 12V AC/DC | 11 |
| 24V AC/DC | 22 |
| 120V AC | QH2 |
| 240V AC | QM4 |

④ Transformer Voltage Codes

| Voltage | Code |
|---------|------|
| 120VAC | 126 |
| 240VAC | 246 |
| 480VAC | 486 |

 Transformers step down to 6V.

Stop Switches (Sub-Assembled)

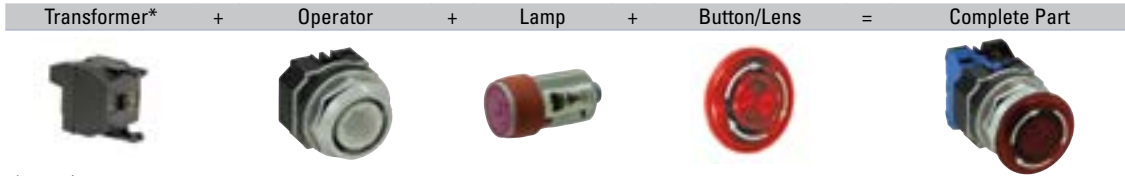

* Not required for full voltage units.

Operators



| Style | Part Number |
|--|-------------|
|  ø40mm Illuminated and Non-illuminated Pushlock Turn Reset | AVD000T8 |
|  ø 40mm Illuminated and Non-illuminated Push-Pull | AYD000T8 |

Buttons and Lenses

| Style | Part Number |
|--|-----------------|
|  Button for Pushlock Turn Reset Stop Switches (ø40mm, red only) | AVN3B-R |
|  Lens for Illuminated Pushlock Turn Reset Stop Switches (ø40mm, red only) | AVLN3LU-R |
|  Button for Push-Pull Stop Switches (ø40mm) | AYD3BN-① |
|  Lens for Illuminated Push-Pull Stop Switches (ø40mm) | AYLD3L-② 2 pos* |

1. In place of ①, specify the Button Color Code. (See table below)
2. In place of ②, specify the LED Color Code.
3. *Not available in blue.

Lamp Circuit Components

| Style | Application | Part Number |
|---|---|-------------|
|  Long Lamp Holder | Used with Full-size Transformer and two contact blocks Used with Full Voltage Adaptor and two contact blocks | TW-LH2 |
|  Lead Holder | Used with TW-LH2 holder when using four contact blocks | HW-LH3 |

Lamps

| Style | Voltage | Part Number |
|--|-----------|-------------|
|  LED | 6V AC/DC | LSTD-6③ |
| | 12V AC/DC | LSTD-1③ |
| | 24V AC/DC | LSTD-2③ |
| | 120V AC | LSTD-H2③ |
| | 240V AC | LSTD-M4③ |

1. In place of ③, specify the LED color code.
2. The LED contains a current-limiting resistor and a protection diode.

① Button Color Codes

| Color | Code |
|--------|------|
| Black | B |
| Green | G |
| Red | R |
| Blue | S |
| Yellow | Y |

② Lens Color Codes

| Color | Code |
|-------|------|
| Amber | A |
| Green | G |
| Red | R |
| Blue | S |
| White | W |

③ LED Color Codes

| Color | Code |
|-------|------|
| Amber | A |
| Green | G |
| Red | R |
| Blue | S |
| White | W |

Contact Blocks

| Style | Part Number | |
|--|------------------------|------------------------|
| | 1NO | 1NC |
|  All Control Units | HW-U10-F | HW-U01-F |
| | HW-U10R-F (early make) | HW-U01R-F (late break) |
|  Dummy Block | HW-DB | |



1. Dummy blocks (no contacts) are used with an odd number of contact blocks.
2. Combining HW-U10R-F and HW-U01R-F result in overlapping contacts.

Transformers

| Style | Primary Voltage (50/60Hz) | Part Number |
|---|---------------------------|-------------|
|  | 120V AC | TW-F126B |
| | 240V AC | TW-F246B |
| | 480V AC | HW-L486 |

6V secondary voltage (uses 6V LED).

Full Voltage Modules

| Style | Description | Part Number |
|--|---|-------------|
|  Dummy Block with Full Voltage Adaptor | For use with odd number of contacts. Finger-Safe | HW-DA1FBN |
|  Full Voltage Adaptor | For use with even number of contacts. Finger-Safe | TW-DA1FB |

All Transformers step down to 6V (use 6V lamp).

Pilot Lights (Assembled)



Assembled Pilot Lights

A P D 1 126 D NU R

Function _____
P: Pilot Light

Series Designation _____
D: TWND Series

Lens Shape _____
1: Dome

Rated Operational Voltage (Primary) _____

Transformer Type Full Voltage Type
126: 120V AC 66: 6VAC/DC
246: 240V AC 11: 12VAC/DC
486: 480V AC 22: 24VAC/DC
QH2: 120VAC
QM4: 240VAC

Lens Color Code

A: Amber
G: Green
R: Red
S: Blue
W: White
Y: Yellow

D: LED

Use only when interpreting part numbers. Do not use for developing part numbers.

LED Pilot Lights

| Style | Operating Voltage | Part Number |
|--|-------------------|------------------------------------|
| | | LED |
|  Transformer Dome | 120V AC | APD1126DNU ^② |
| | 240V AC | APD1246DNU ^② |
| | 480V AC | APD1486DNU ^② |
|  Full Voltage Dome | — | APD1 ^③ DNU ^② |

② Lens Color Codes

| Color | Code |
|--------|------|
| Amber | A |
| Green | G |
| Red | R |
| Blue | S |
| White | W |
| Yellow | Y |

③ Full Voltage Codes

| Voltage | Code |
|-----------|------|
| 6V AC/DC | 66 |
| 12V AC/DC | 11 |
| 24V AC/DC | 22 |
| 120V AC | QH2 |
| 240V AC | QM4 |

- 1. In place of ^②, specify the Lens/LED Color Code.
- 2. In place of ^③, specify the Full Voltage Code (LED voltage).
- 3. Yellow pilot light comes with white LED.

Pilot Lights (Sub-Assembled)

Transformer* + Operator + Lamp + Lens = Complete Part



* Not required for full voltage units.

One Each from Left Column plus **One Selection from Right Column**

Operators

| Style | Part Number |
|-----------------------------|-------------|
| Transformer or FULL Voltage | APD09ST8 |

Full Voltage Clips

| Primary Voltage (50/60Hz) | Part Number |
|---------------------------|-------------|
| | APD-F |



Required for all full voltage models. Two pieces each. 2 clips required for full voltage pilot lights

Transformers (only for Pilot Lights)

| Style | Primary Voltage (50/60Hz) | Part Number |
|-------|---------------------------|-------------|
| LED | 120V AC | TWD-0126 |
| | 240V AC | TWD-0246 |
| | 480V AC | TWD-0486 |



6V secondary voltage (use 6V lamp).

Lenses

| Style | Part Number |
|-----------|-------------|
| Dome Lens | APN106LN-② |



1. In place of ②, specify the Lens Color Code.

Lamps

| Style | Voltage | Part Number |
|-------|-----------|-------------|
| LED | 6V AC/DC | LSTD-6③ |
| | 12V AC/DC | LSTD-1③ |
| | 24V AC/DC | LSTD-2③ |
| | 120V AC | LSTD-H2③ |
| | 240V AC | LSTD-M4③ |



1. In place of ②, specify the LED color code.
2. The LED contains a current-limiting resistor and a protection diode.

② Lens Color Codes

| Color | Code |
|--------|------|
| Amber | A |
| Green | G |
| Red | R |
| Blue | S |
| White | W |
| Yellow | Y |

③ LED Color Codes

| Color | Code |
|-------|------|
| Amber | A |
| Green | G |
| Red | R |
| Blue | S |
| White | W |



Yellow LED not available, use white LED with Yellow lens.

Illuminated Pushbuttons (Assembled)

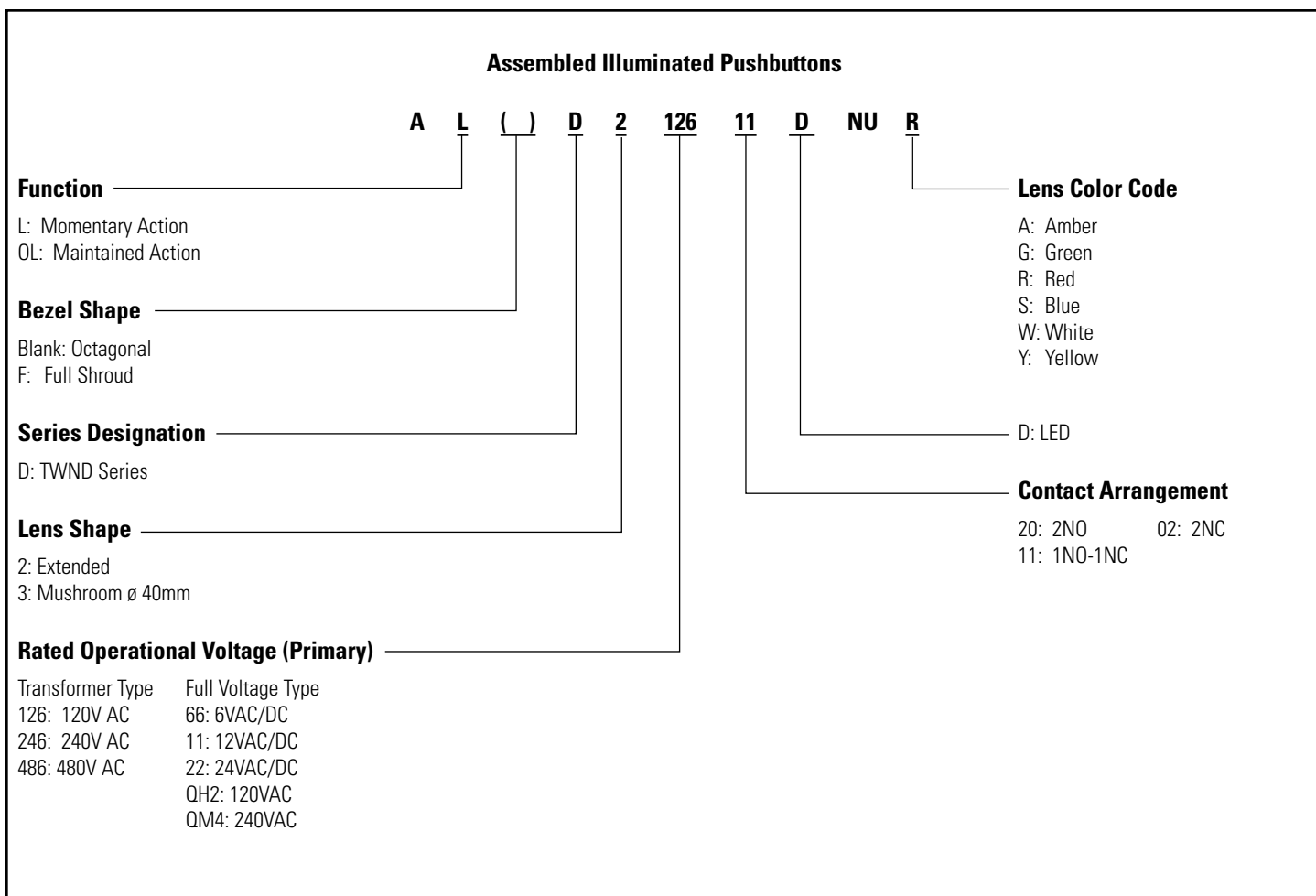

1. Use only when interpreting part numbers. Do not use for developing part numbers.
2. All transformers step down to 6V.

Illuminated Pushbuttons (Assembled)

Illuminated Pushbuttons

| Style | Contacts | Part Number | | |
|---|--------------|-----------------------|--|---|
| | | Momentary | Maintained | |
| Extended Lens  | Full Voltage | 1NO-1NC 2NO 2NC | ALD2Ⓞ11DNUⓄ ALD2Ⓞ20DNUⓄ ALD2Ⓞ02DNUⓄ | AOLD2Ⓞ11DNUⓄ AOLD2Ⓞ20DNUⓄ AOLD2Ⓞ02DNUⓄ |
| | Transformer | 1NO-1NC 2NO 2NC | ALD2 ⊕ 11DNUⓄ ALD2 ⊕ 20DNUⓄ ALD2 ⊕ 02DNUⓄ | AOLD2 ⊕ 11DNUⓄ AOLD2 ⊕ 20DNUⓄ AOLD2 ⊕ 02DNUⓄ |
| Extended Lens with Full Shroud  | Full Voltage | 1NO-1NC 2NO 2NC | ALFD2Ⓞ11DNUⓄ ALFD2Ⓞ20DNUⓄ ALFD2Ⓞ02DNUⓄ | AOLFD2Ⓞ11DNUⓄ AOLFD2Ⓞ20DNUⓄ AOLFD2Ⓞ02DNUⓄ |
| | Transformer | 1NO-1NC 2NO 2NC | ALFD2 ⊕ 11DNUⓄ ALFD2 ⊕ 20DNUⓄ ALFD2 ⊕ 02DNUⓄ | AOLFD2 ⊕ 11DNUⓄ AOLFD2 ⊕ 20DNUⓄ AOLFD2 ⊕ 02DNUⓄ |
| ø 40mm Mushroom Lens  | Full Voltage | 1NO-1NC 2NO 2NC | ALD3Ⓞ11DNUⓄ ALD3Ⓞ20DNUⓄ ALD3Ⓞ02DNUⓄ | AOLD3Ⓞ11DNUⓄ AOLD3Ⓞ20DNUⓄ AOLD3Ⓞ02DNUⓄ |
| | Transformer | 1NO-1NC 2NO 2NC | ALD3 ⊕ 11DNUⓄ ALD3 ⊕ 20DNUⓄ ALD3 ⊕ 02DNUⓄ | AOLD3 ⊕ 11DNUⓄ AOLD3 ⊕ 20DNUⓄ AOLD3 ⊕ 02DNUⓄ |

② Lens Color Codes

| Color | Code |
|--------|------|
| Amber | A |
| Green | G |
| Red | R |
| Blue | S |
| White | W |
| Yellow | Y |

③ Full Voltage Codes

| Voltage | Code |
|-----------|------|
| 6V AC/DC | 66 |
| 12V AC/DC | 11 |
| 24V AC/DC | 22 |
| 120V AC | QH2 |
| 240V AC | QM4 |

④ Transformer Voltage Codes

| Voltage | Code |
|---------|------|
| 120VAC | 126 |
| 240VAC | 246 |
| 480VAC | 486 |

 6V secondary voltage (uses 6V LED).

- 1. In place of Ⓞ, specify the Lens Color Code.
- 2. In place of Ⓞ, specify the Full Voltage Code (LED voltage).
- 3. In place of ⊕, specify the Transformer Voltage Code.
- 4. Light is independent of switch position.
- 5. Yellow pushbutton comes with white LED only.

Illuminated Pushbuttons (Sub-Assembled)

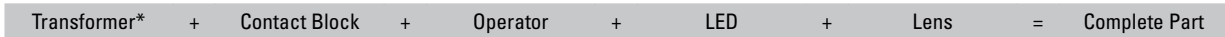

*Not required for full voltage types.

Operators

| Style | Image | Part Number | |
|---------------------------|-------|-------------|-------------|
| | | Momentary | Maintained |
| Extended | | ALD2300T8 | AOLD2300T8 |
| Extended with Full Shroud | | ALFD2300T8 | AOLFD2300T8 |
| 40mm Mushroom | | ALD2300T8 | AOLD2300T8 |

Lenses

| Style | Image | Part Number |
|-----------------|-------|-------------|
| Extended | | ALN06LU-Ⓞ |
| ø 40mm Mushroom | | ALN3LU-Ⓞ |

In place of Ⓞ, specify the Lens Color Code.

Lamp Circuit Components

| Style | Application | Part Number |
|----------------------|---|-------------|
| Long Lamp Holder | Used with Full-size Transformer and two contact blocks Used with Full Voltage Adaptor and two contact blocks | TW-LH2 |
| Lead Holder | Used with TW-LH2 holder when using four contact blocks | HW-LH3 |

Lamps

| Style | Voltage | Part Number |
|-------|-----------|-------------|
| | 6V AC/DC | LSTD-6Ⓞ |
| | 12V AC/DC | LSTD-1Ⓞ |
| | 24V AC/DC | LSTD-2Ⓞ |
| | 120V AC | LSTD-H2Ⓞ |
| | 240V AC | LSTD-M4Ⓞ |

1. In place of Ⓞ, specify the LED color code.
2. The LED contains a current-limiting resistor and a protection diode.

Ⓞ Lens Color Codes

| Color | Code |
|--------|------|
| Amber | A |
| Green | G |
| Red | R |
| Blue | S |
| White | W |
| Yellow | Y |

Ⓞ LED Color Codes

| Color | Code |
|-------|------|
| Amber | A |
| Green | G |
| Red | R |
| Blue | S |
| White | W |

Yellow lens only. Yellow LED not available, use white LED.

Contact Blocks

| Style | Image | Part Number | |
|-------------------|-------|------------------------|------------------------|
| | | 1NO | 1NC |
| All Control Units | | HW-U10-F | HW-U01-F |
| | | HW-U10R-F (early make) | HW-U01R-F (late break) |
| Dummy Block | | HW-DB | |

1. Dummy blocks (no contacts) are used with an odd number of contact blocks.
2. Combining HW-U10R-F and HW-U01R-F result in overlapping contacts (remain on, or closed, when switch is moved between two positions).

Transformers

| Style | Primary Voltage (50/60Hz) | Part Number |
|-------|---------------------------|-------------|
| | 120V AC | TW-F126B |
| | 240V AC | TW-F246B |
| | 480V AC | HW-L486 |

6V secondary voltage (use 6V LED).

Full Voltage Modules

| Style | Description | Part Number |
|---|--|-------------|
| Dummy Block with Full Voltage Adaptor | For use with odd number of contacts. Finger-Safe | HW-DA1FBN |
| Full Voltage Adaptor | For use with even number of contacts. Finger-Safe | TW-DA1FB |

All Transformers step down to 6V (use 6V lamp).

Non-Illuminated Selector Switches (Assembled)



Assembled Selector Switches

A S D 2 () () 11 NU - ()

Function

S: Selector Switch

Series Designation

D: TWND Series

Number of Positions

2: 2-Position
3: 3-Position

Spring Return Action

Blank: Maintained
1: Spring return from Right
2: Spring return from Left
3: 2-Way spring return from Left and Right

Circuit Number

(See Circuit # column of Selector Switch Contact Arrangement Chart on beginning on page 764.)

Contact Arrangement Code

10: 1NO 01: 1NC
20: 2NO 02: 2NC
40: 4NO 04: 4NC
11: 1NO-1NC 22: 2NO-2NC

Operator Style Code

Blank: Knob Operator
L: Lever Operator
K: Key Operator

- 1. Use only when interpreting part numbers. Do not use for developing part numbers.
- 2. Custom key removal codes available. Please contact IDEC for details.

Non-Illuminated Selector Switches (Assembled)

Non-Illuminated 2-Position Selector Switches

| Style | | | | | Part Number | | |
|------------|----------|-------------------|---|----------------------|---------------|--------------------------|-------------------------|
| Contact | Mounting | Operator Position | | | Maintained | Spring Return from Right | Spring Return from Left |
| | | L | R | | | | |
| | | | | | | | |
| 1NO | 1 | 0 | X | Knob Lever Key | ASD210NU | ASD2110NU | ASD2210NU |
| | 2 | 0 | 0 | | ASD2L10NU | ASD21L10NU | ASD22L10NU |
| | | | | | ASD2K10NU | ASD21K10NU | ASD22K10NU |
| 1NC | 1 | X | 0 | Knob Lever Key | ASD201NU | ASD2101NU | ASD2201NU |
| | 2 | 0 | 0 | | ASD2L01NU | ASD21L01NU | ASD22L01NU |
| | | | | | ASD2K01NU | ASD21K01NU | ASD22K01NU |
| 1NO 1NC | 1 | 0 | X | Knob Lever Key | ASD211NU | ASD2111NU | ASD2211NU |
| | 2 | X | 0 | | ASD2L11NU | ASD21L11NU | ASD22L11NU |
| | | | | | ASD2K11NU | ASD21K11NU | ASD22K11NU |
| 2NO | 1 | 0 | X | Knob Lever Key | ASD220NU | ASD2120NU | ASD2220NU |
| | 2 | 0 | X | | ASD2L20NU | ASD21L20NU | ASD22L20NU |
| | | | | | ASD2K20NU | ASD21K20NU | ASD22K20NU |
| 2NC | 1 | X | 0 | Knob Lever Key | ASD202NU | ASD2102NU | ASD2202NU |
| | 2 | X | 0 | | ASD2L02NU | ASD21L02NU | ASD22L02NU |
| | | | | | ASD2K02NU | ASD21K02NU | ASD22K02NU |
| 2NO 2NC | 1 | 0 | X | Knob Lever Key | ASD222NU | ASD2122NU | ASD2222NU |
| | 2 | X | 0 | | ASD2L22NU | ASD21L22NU | ASD22L22NU |
| | 3 | 0 | X | | ASD2K22NU | ASD21K22NU | ASD22K22NU |
| | 4 | X | 0 | | | | |
| 2NO 2NC | 1 | 0 | X | Knob Lever Key | ASD222NU-111 | ASD2122NU-111 | ASD2222NU-111 |
| | 2 | 0 | X | | ASD2L22NU-111 | ASD21L22NU-111 | ASD22L22NU-111 |
| | 3 | X | 0 | | ASD2K22NU-111 | ASD21K22NU-111 | ASD22K22NU-111 |
| | 4 | X | 0 | | | | |



- The truth table indicates the operating position of contact block when the operator is switched to that position.
X = On (closed contacts) 0 = Off (open contacts)
X-X = Overlapping Contacts: Remain on (closed contacts) when switch is moved between these two positions.
- All knob and lever selector switches come in black. Other colors are available by ordering the knob or lever separately.
- Custom contact arrangements available, see page 764.

Non-Illuminated 3-Position Selector Switches

| Style | | | | | | Part Number | | | |
|------------|----------|-------------------|---|---|----------------------|---------------|--------------------------|-------------------------|-----------------------|
| Contact | Mounting | Operator Position | | | | Maintained | Spring Return from Right | Spring Return from Left | Spring Return Two-Way |
| | | L | C | R | | | | | |
| | | | | | | | | | |
| 2NO | 1 | X | 0 | 0 | Knob Lever Key | ASD320NU | ASD3120NU | ASD3220NU | ASD3320NU |
| | 2 | 0 | 0 | X | | ASD3L20NU | ASD31L20NU | ASD32L20NU | ASD33L20NU |
| | | | | | | ASD3K20NU | ASD31K20NU | ASD32K20NU | ASD33K20NU |
| 2NC | 1 | 0 | X | X | Knob Lever Key | ASD302NU | ASD3102NU | ASD3202NU | ASD3302NU |
| | 2 | X | X | 0 | | ASD3L02NU | ASD31L02NU | ASD32L02NU | ASD33L02NU |
| | | | | | | ASD3K02NU | ASD31K02NU | ASD32K02NU | ASD33K02NU |
| 2NO 2NC | 1 | X | 0 | 0 | Knob Lever Key | ASD322NU | ASD3122NU | ASD3222NU | ASD3322NU |
| | 2 | 0 | 0 | X | | ASD3L22NU | ASD31L22NU | ASD32L22NU | ASD33L22NU |
| | 3 | 0 | X | X | | ASD3K22NU | ASD31K22NU | ASD32K22NU | ASD33K22NU |
| | 4 | X | X | 0 | | | | | |
| 2NO 2NC | 1 | X | 0 | X | Knob Lever Key | ASD322NU-309 | ASD3122NU-309 | ASD3222NU-309 | ASD3322NU-309 |
| | 2 | X | X | 0 | | ASD3L22NU-309 | ASD31L22NU-309 | ASD32L22NU-309 | ASD33L22NU-309 |
| | 3 | 0 | X | 0 | | ASD3K22NU-309 | ASD31K22NU-309 | ASD32K22NU-309 | ASD33K22NU-309 |
| | 4 | 0 | 0 | X | | | | | |
| 2NO 2NC | 1 | 0 | X | 0 | Knob Lever Key | ASD322NU-310 | ASD3122NU-310 | ASD3222NU-310 | ASD3322NU-310 |
| | 2 | 0 | 0 | X | | ASD3L22NU-310 | ASD31L22NU-310 | ASD32L22NU-310 | ASD33L22NU-310 |
| | 3 | 0 | X | 0 | | ASD3K22NU-310 | ASD31K22NU-310 | ASD32K22NU-310 | ASD33K22NU-310 |
| | 4 | 0 | 0 | X | | | | | |
| 4NO | 1 | X | 0 | 0 | Knob Lever Key | ASD340NU | ASD3140NU | ASD3240NU | ASD3340NU |
| | 2 | 0 | 0 | X | | ASD3L40NU | ASD31L40NU | ASD32L40NU | ASD33L40NU |
| | 3 | X | 0 | 0 | | ASD3K40NU | ASD31K40NU | ASD32K40NU | ASD33K40NU |
| | 4 | 0 | 0 | X | | | | | |
| 4NC | 1 | 0 | X | X | Knob Lever Key | ASD304NU | ASD3104NU | ASD3204NU | ASD3304NU |
| | 2 | X | X | 0 | | ASD3L04NU | ASD31L04NU | ASD32L04NU | ASD33L04NU |
| | 3 | 0 | X | X | | ASD3K04NU | ASD31K04NU | ASD32K04NU | ASD33K04NU |
| | 4 | X | X | 0 | | | | | |

Non-Illuminated Selector Switches (Sub-Assembled)

Contact Blocks + Operator + Knob or Lever* + Color Insert* = Complete Part†



- 1. *Not needed with key type switches.
- 2. †Knob type shown.

Operators

| Style | Position | Description | Part Number | |
|---|-------------------------|--|--|----------------------------|
|  Knob/Lever | 2 | Maintained | ASD0201T8 | |
| | | Spring return from right | ASD0213T8 | |
| | | Spring return from left | ASD0224T8 | |
| | 3 | Maintained, Cam 1 Maintained, Cam 2 | | ASD0302T8 ASD0306T8 |
| | | | Spring return from right, Cam 1 Spring return from right, Cam 2 | ASD0314T8 ASD0310T8 |
| | | Spring return from left, Cam 1 Spring return from left, Cam 2 | | ASD0323T8 ASD0328T8 |
| Spring return from left/right, Cam 1 Spring return from left/right, Cam 2 | | | ASD0335T8 ASD0339T8 | |
|  Key | | 2 | Maintained | ASD0201KT8 |
| | | | Spring return from right | ASD0213KT8 |
| | Spring return from left | | ASD0224KT8 | |
| | 3 | Maintained, Cam 1 Maintained, Cam 2 | | ASD0302KT8 ASD0306KT8 |
| | | | Spring return from right, Cam 1 Spring return from right, Cam 2 | ASD0302KT8B ASD0310KT8B |
| | | Spring return from left, Cam 1 Spring return from left, Cam 2 | | ASD0323KT8 ASD0310KT8B |
| Spring return from left/right, Cam 1 Spring return from left/right, Cam 2 | | | ASD0335KT8 ASD3K339KT8 | |



- 1. Order knobs, levers, color inserts separately (see below).
- 2. For key switches, keys are removable in all maintained positions. Other options available, contact IDEC for details.
- 3. See page 766 "Operator Truth Tables" for details of difference between cams.

① Color Codes

| Knob/Lever Color | Code |
|------------------|------|
| Black | B |
| Blue | S |
| Green | G |
| Red | R |
| Yellow | Y |
| White | W |

- 1. Knob/Lever not available in white.
- 2. Color inserts not available in Black.
- 3. Lever not available in yellow.

Handles and Inserts

| Style | Part Number |
|---|-------------|
|  Knob | ASDHHY-① |
|  Lever | ASDHL-①* |
|  Color Insert | TW-HC1-① |

- 1. In place of ①, specify the Color Code.
*Not available in yellow.

Contact Blocks

| Style | Part Number | |
|--|------------------------------------|------------------------------------|
| | 1NO | 1NC |
|  All Control Units | HW-U10-F HW-U10R-F (early make) | HW-U01-F HW-U01R-F (late break) |
|  Dummy Block | HW-DB | |

- 1. Dummy blocks (no contacts) are used with an odd number of contact blocks.
- 2. Combining HW-U10R-F and HW-U01R-F result in overlapping contacts (remain on, or closed, when switch is moved between two positions).

Illuminated Selector Switches (Assembled)



Assembled Illuminated Selector Switches

A SL D 2 (2) 22 11 DN U - 111 - R

Function

SL: Illuminated Selector Switch

Series Designation

D: TWND series

Number of Positions

2: 2-Position
3: 3-Position

Spring Return Action

Blank: Maintained
1: Spring return from Right
2: Spring return from Left
3: Two-Way spring return from Left and Right

Rated Operational Voltage (Primary)

| | |
|------------------|-------------------|
| Transformer Type | Full Voltage Type |
| 136: 120V AC | 66: 6VAC/DC |
| 256: 240V AC | 11: 12VAC/DC |
| 486: 480V AC | 22: 24VAC/DC |
| | QH2: 120VAC |
| | QM4: 240VAC |

Contact Arrangement Code

20: 2NO 02: 2NC
40: 4NO 04: 4NC
11: 1NO-1NC 22: 2NO-2NC

Lens Color Code

A: Amber
G: Green
R: Red
S: Blue
W: White
Y: Yellow

Circuit Code Number

See Circuit # column of Selector Switch Contact Arrangement Charts on page 764.

D: LED Lamp



Use only when interpreting part numbers. Do not use for developing part numbers.

Illuminated Selector Switches (Assembled)

Illuminated 2-Position Selector Switches

| Style | | | | | Part Number | | |
|---------|----------|-------------------|---|--------------------------|---|---|---|
| Contact | Mounting | Operator Position | | Lamp Circuit Type | Maintained | Spring Return from Right | Spring Return from Left |
| | | L | R | | | | |
| 1NO | 1 | 0 | X | Transformer Full Voltage | ASLD2 ④11DNU② ASLD2③11DNU② | ASLD21 ④11DNU② ASLD21③11DNU② | ASLD22 ④11DNU② ASLD22③11DNU② |
| 1NC | 2 | X | 0 | | | | |
| 2NO | 1 | 0 | X | Transformer Full Voltage | ASLD2 ④20DNU② ASLD2③20DNU② | ASLD21 ④20DNU② ASLD21③20DNU② | ASLD22 ④20DNU② ASLD22③20DNU② |
| 2NC | 2 | X | 0 | | | | |
| 2NO | 1 | 0 | X | Transformer Full Voltage | ASLD2 ④22DNU② ASLD2③22DNU② | ASLD21 ④22DNU② ASLD21③22DNU② | ASLD22 ④22DNU② ASLD22③22DNU② |
| 2NC | 2 | X | 0 | | | | |
| 2NC | 3 | 0 | X | | | | |
| 2NC | 4 | X | 0 | | | | |
| 2NO | 1 | 0 | X | Transformer Full Voltage | ASLD2 ④22DNU-111-② ASLD2③22DNU-111-② | ASLD21 ④22DNU-111-② ASLD21③22DNU-111-② | ASLD22 ④22DNU-111-② ASLD22③22DNU-111-② |
| 2NC | 2 | 0 | X | | | | |
| 2NC | 3 | X | 0 | | | | |
| 2NC | 4 | X | 0 | | | | |

② Lens Color Codes

| Color | Code |
|--------|------|
| Amber | A |
| Green | G |
| Red | R |
| Blue | S |
| White | W |
| Yellow | Y |

③ Full Voltage Codes

| Voltage | Code |
|-----------|------|
| 6V AC/DC | 66 |
| 12V AC/DC | 11 |
| 24V AC/DC | 22 |
| 120V AC | QH2 |
| 240V AC | QM4 |

Illuminated 3-Position Selector Switches, Maintained and Spring Return

| Style | | | | | Part Number | | | | |
|---------|----------|-------------------|---|---|--------------------------|--|--|--|--|
| Contact | Mounting | Operator Position | | | Lamp Circuit Type | Maintained | Spring Return From Right | Spring Return from Left | Spring Return Two-Way |
| | | L | C | R | | | | | |
| 2NO | 1 | X | 0 | 0 | Transformer Full Voltage | ASLD3 ④ 20DNU② ASLD3③20DNU② | ASLD31 ④ 20DNU② ASLD31③20DNU② | ASLD32 ④ 20DNU② ASLD32③20DNU② | ASLD33 ④ 20DNU② ASLD33③20DNU② |
| 2NC | 2 | 0 | 0 | X | | | | | |
| 2NC | 1 | 0 | X | X | Transformer Full Voltage | ASLD3 ④ 02DNU② ASLD3③02DNU② | ASLD31 ④ 02DNU② ASLD31③02DNU② | ASLD32 ④ 02DNU② ASLD32③02DNU② | ASLD33 ④ 02DNU② ASLD33③02DNU② |
| 2NC | 2 | X | X | 0 | | | | | |
| 2NO | 1 | X | 0 | 0 | Transformer Full Voltage | ASLD3 ④ 22DNU② ASLD3③22DNU② | ASLD31 ④ 22DNU② ASLD31③22DNU② | ASLD32 ④ 22DNU② ASLD32③22DNU② | ASLD33 ④ 22DNU② ASLD33③22DNU② |
| 2NC | 2 | 0 | 0 | X | | | | | |
| 2NC | 3 | 0 | X | X | | | | | |
| 2NC | 4 | X | X | 0 | | | | | |
| 2NO | 1 | X | 0 | X | Transformer Full Voltage | ASLD3 ④ 22DNU-309-② ASLD3③22DNU-309-② | ASLD31 ④ 22DNU-309-② ASLD31③22DNU-309-② | ASLD32 ④ 22DNU-309-② ASLD32③22DNU-309-② | ASLD33 ④ 22DNU-309-② ASLD33③22DNU-309-② |
| 2NC | 2 | X | X | 0 | | | | | |
| 2NC | 3 | 0 | X | 0 | | | | | |
| 2NO | 1 | 0 | X | 0 | Transformer Full Voltage | ASLD3 ④ 22DNU-310-② ASLD3③22DNU-310-② | ASLD31 ④ 22DNU-310-② ASLD31③22DNU-310-② | ASLD32 ④ 22DNU-310-② ASLD32③22DNU-310-② | ASLD33 ④ 22DNU-310-② ASLD33③22DNU-310-② |
| 2NC | 2 | 0 | 0 | X | | | | | |
| 2NC | 3 | 0 | X | 0 | | | | | |
| 2NC | 4 | 0 | 0 | X | | | | | |
| 4NO | 1 | X | 0 | 0 | Transformer Full Voltage | ASLD3 ④ 40DNU② ASLD3③40DNU② | ASLD31 ④ 40DNU② ASLD31③40DNU② | ASLD32 ④ 40DNU② ASLD32③40DNU② | ASLD33 ④ 40DNU② ASLD33③40DNU② |
| 4NO | 2 | 0 | 0 | X | | | | | |
| 4NO | 3 | X | 0 | 0 | | | | | |
| 4NC | 1 | 0 | X | X | Transformer Full Voltage | ASLD3 ④ 04DNU② ASLD3③04DNU② | ASLD31 ④ 04DNU② ASLD31③04DNU② | ASLD32 ④ 04DNU② ASLD32③04DNU② | ASLD33 ④ 04DNU② ASLD33③04DNU② |
| 4NC | 2 | X | X | 0 | | | | | |
| 4NC | 3 | 0 | X | X | | | | | |
| 4NC | 4 | X | X | 0 | | | | | |

- In place of ②, specify the Lens/LED Color Code, in place of ③, specify the Full Voltage (LED voltage) Code, in place of ④, specify the Transformer Voltage Code.
- The truth table indicates the operating position of contact block when the operator is switched to that position.
X = On (Closed Contacts) 0 = Off (Open Contacts)
X—X = Overlapping Contacts: Remain on (closed contacts) when switch is moved between these positions
- Yellow selector switch comes with white LED.

④ Transformer Voltage Codes

| Voltage | Code |
|---------|------|
| 120VAC | 136 |
| 240VAC | 256 |
| 480VAC | 486 |

Transformers step down to 6V (use 6V LED).

Illuminated Selector Switches (Sub-Assembled)



*Not required for full voltage units.

Operators

| Style | Position | Description | Part Number |
|---|----------|--------------------------------------|-------------|
| Operator  | 2 | Maintained | ASLD0201T8 |
| | 3 | Maintained, Cam 1 | ASLD0302T8 |
| | | Maintained, Cam 2 | ASLD0306T8 |
| | 2 | Spring return from right | ASLD0213T8 |
| | | Spring return from left | ASLD0224T8 |
| | 3 | Spring return from right, Cam 1 | ASLD0314T8 |
| | | Spring return from right, Cam 2 | ASLD0310T8 |
| | | Spring return from left, Cam 1 | ASLD0323T8 |
| | | Spring return from left, Cam 2 | ASLD0328T8 |
| | | Spring return from left/right, Cam 1 | ASLD0335T8 |
| Spring return from left/right, Cam 2 | | ASLD0339T8 | |

Lenses

| Style | Part Number |
|---|-------------|
| Knob  | ASLNHU-③ ② |

Lamps

| Style | Voltage | Part Number |
|--|-----------|-------------|
| LED  | 6V AC/DC | LSTD-6③ |
| | 12V AC/DC | LSTD-1③ |
| | 24V AC/DC | LSTD-2③ |
| | 120V AC | LSTD-H2③ |
| | 240V AC | LSTD-M4③ |



- In place of ②, specify the LED color code.
- The LED contains a current-limiting resistor and a protection diode.

Contact Blocks



| Style | Part Number | |
|--|------------------------|------------------------|
| | 1NO | 1NC |
| All Control Units  | HW-U10-F | HW-U10-F |
| | HW-U10R-F (early make) | HW-U10R-F (late break) |
| Dummy Block  | HW-DB | |

- Dummy blocks (no contacts) are used with an odd number of contact blocks.
- Combining HW-U10R-F and HW-U01R-F result in overlapping contacts (remain on, or closed, when switch is moved between two positions).

Lamp Circuit Components

| Style | Application | Part Number |
|---|---|-------------|
| Long Lamp Holder  | Used with Full-size Transformer and two contact blocks | TW-LH2 |
| Lead Holder  | Used with Full Voltage Adaptor and two contact blocks | |
| | Used with TW-LH2 holder when using four contact blocks | HW-LH3 |

Full Voltage Modules

| Style | Description | Part Number |
|--|---|-------------|
| Dummy Block with Full Voltage Adaptor  | For use with odd number of contacts. Finger-Safe | HW-DA1FBN |
| Full Voltage Adaptor  | For use with even number of contacts. Finger-Safe | TW-DA1FB |

- All Transformers step down to 6V (use 6V lamp).

Transformers

| Style | Primary Voltage (50/60Hz) | Part Number |
|--|---------------------------|-------------|
| Transformers  | 120V AC | TW-F126B |
| | 240V AC | TW-F126B |
| | 480V AC | HW-L486 |

- 6V secondary voltage.

② Lens Color Codes

| Color | Code |
|--------|------|
| Amber | A |
| Green | G |
| Red | R |
| Blue | S |
| White | W |
| Yellow | Y |

③ LED Color Codes

| Color | Code |
|-------|------|
| Amber | A |
| Green | G |
| Red | R |
| Blue | S |
| White | W |

- Yellow lens only. Yellow LED not available, use white LED.

Contact Arrangement Charts

How to Read Contact Arrangement Charts

To determine contact block mounting position, first make sure the selector switch is oriented as shown on the right

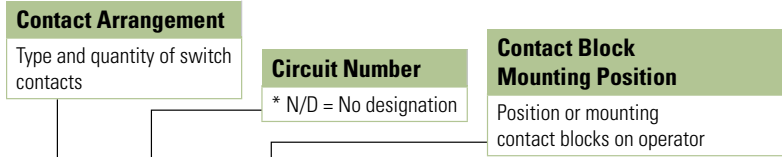
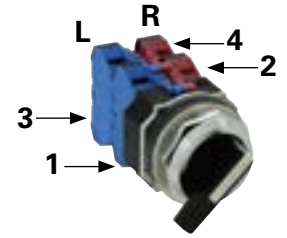

Operator Position

Truth table indicates the operating position of contact block when operator is switched to that position.

X = On (Closed Contacts)
 O = Off (Open Contacts)
 X-X = Overlapping Contacts: Remain on (closed) when switch is moved between these two positions

Contact Block Part Number

Part number to use when ordering sub-assembly contact blocks, as required for use with corresponding mounting position

Contact Arrangement Chart: 2-Position Selector Switches

| Style | | Mounting Position | Operator Position | | Contact Block Part Number | Description | Operator Part Number | | |
|------------------|----------------|-------------------|-------------------|----------|---------------------------|---------------------------------------|---------------------------------------|---------------------------------------|---------------------------------------|
| Contact | Circuit Number | | L | R | | | Maintained | Spring Return from Right | Spring Return from Left |
| | | | | | | | L | R | L |
| 1NO | N/D | 1 | O | X | HW-U10-F | Knob/Lever Key | ASD0201T8 ASD0201KT8 ASLD0201T8 | ASD0213T8 ASD0213KT8 ASLD0213T8 | ASD0224T8 ASD0224KT8 ASLD0224T8 |
| | | 2 | O | O | HW-DB | Illuminated Knob | | | |
| 1NC | N/D | 1 | X | O | HW-U01-F | Knob/Lever Key | ASD0201T8 ASD0201KT8 ASLD0201T8 | ASD0213T8 ASD0213KT8 ASLD0213T8 | ASD0224T8 ASD0224KT8 ASLD0224T8 |
| | | 2 | O | O | HW-DB | Illuminated Knob | | | |
| 1NO 1NC | N/D | 1 | O | X | HW-U10-F | Knob/Lever Key | ASD0201T8 ASD0201KT8 ASLD0201T8 | ASD0213T8 ASD0213KT8 ASLD0213T8 | ASD0224T8 ASD0224KT8 ASLD0224T8 |
| | | 2 | X | O | HW-U01-F | Illuminated Knob | | | |
| | 103 | 1 | X | O | HW-U01-F | Knob/Lever Key | ASD0201T8 ASD0201KT8 ASLD0201T8 | ASD0213T8 ASD0213KT8 ASLD0213T8 | ASD0224T8 ASD0224KT8 ASLD0224T8 |
| | | 2 | O | X | HW-U10-F | Illuminated Knob | | | |
| 1NO-EM 1NC-LB | 600 | 1 | O | X | HW-U10R-F | Knob/Lever Key | ASD0201T8 ASD0201KT8 ASLD0201T8 | ASD0213T8 ASD0213KT8 ASLD0213T8 | ASD0224T8 ASD0224KT8 ASLD0224T8 |
| | | 2 | X | O | HW-U01R-F | Illuminated Knob | | | |
| | 601 | 1 | X | O | HW-U01R-F | Knob/Lever Key | ASD0201T8 ASD0201KT8 ASLD0201T8 | ASD0213T8 ASD0213KT8 ASLD0213T8 | ASD0224T8 ASD0224KT8 ASLD0224T8 |
| | | 2 | O | X | HW-U10R-F | Illuminated Knob | | | |
| 2NO | N/D | 1 | O | X | HW-U10-F | Knob/Lever Key | ASD0201T8 ASD0201KT8 ASLD0201T8 | ASD0213T8 ASD0213KT8 ASLD0213T8 | ASD0224T8 ASD0224KT8 ASLD0224T8 |
| | | 2 | O | X | HW-U10-F | Illuminated Knob | | | |
| 2NC | N/D | 1 | X | O | HW-U01-F | Knob/Lever Key | ASD0201T8 ASD0201KT8 ASLD0201T8 | ASD0213T8 ASD0213KT8 ASLD0213T8 | ASD0224T8 ASD0224KT8 ASLD0224T8 |
| | | 2 | X | O | HW-U01-F | Illuminated Knob | | | |
| 2NO 2NC | N/D | 1 | O | X | HW-U10-F | Knob/Lever Key | ASD0201T8 ASD0201KT8 ASLD0201T8 | ASD0213T8 ASD0213KT8 ASLD0213T8 | ASD0224T8 ASD0224KT8 ASLD0224T8 |
| | | 2 | X | O | HW-U01-F | Illuminated Knob | | | |
| | | 3 | O | X | HW-U10-F | Knob/Lever Key | ASD0201T8 ASD0201KT8 ASLD0201T8 | ASD0213T8 ASD0213KT8 ASLD0213T8 | ASD0224T8 ASD0224KT8 ASLD0224T8 |
| | | 4 | X | O | HW-U01-F | Illuminated Knob | | | |
| | 110 | 1 | X | O | HW-U01-F | Knob/Lever Key | ASD0201T8 ASD0201KT8 ASLD0201T8 | ASD0213T8 ASD0213KT8 ASLD0213T8 | ASD0224T8 ASD0224KT8 ASLD0224T8 |
| | | 2 | O | X | HW-U10-F | Illuminated Knob | | | |
| | | 3 | X | O | HW-U01-F | Knob/Lever Key | ASD0201T8 ASD0201KT8 ASLD0201T8 | ASD0213T8 ASD0213KT8 ASLD0213T8 | ASD0224T8 ASD0224KT8 ASLD0224T8 |
| | | 4 | O | X | HW-U10-F | Illuminated Knob | | | |
| 111 | 1 | O | X | HW-U10-F | Knob/Lever Key | ASD0201T8 ASD0201KT8 ASLD0201T8 | ASD0213T8 ASD0213KT8 ASLD0213T8 | ASD0224T8 ASD0224KT8 ASLD0224T8 | |
| | 2 | O | X | HW-U10-F | Knob/Lever Key | ASD0201T8 ASD0201KT8 ASLD0201T8 | ASD0213T8 ASD0213KT8 ASLD0213T8 | ASD0224T8 ASD0224KT8 ASLD0224T8 | |
| | 3 | X | O | HW-U01-F | Illuminated Knob | | | | |
| | 4 | X | O | HW-U01-F | Illuminated Knob | | | | |
| 4NO | N/D | 1 | O | X | HW-U10-F | Knob/Lever Key | ASD0201T8 ASD0201KT8 ASLD0201T8 | ASD0213T8 ASD0213KT8 ASLD0213T8 | ASD0224T8 ASD0224KT8 ASLD0224T8 |
| | | 2 | O | X | HW-U10-F | Knob/Lever Key | ASD0201T8 ASD0201KT8 ASLD0201T8 | ASD0213T8 ASD0213KT8 ASLD0213T8 | ASD0224T8 ASD0224KT8 ASLD0224T8 |
| | | 3 | O | X | HW-U10-F | Knob/Lever Key | ASD0201T8 ASD0201KT8 ASLD0201T8 | ASD0213T8 ASD0213KT8 ASLD0213T8 | ASD0224T8 ASD0224KT8 ASLD0224T8 |
| | | 4 | O | X | HW-U10-F | Knob/Lever Key | ASD0201T8 ASD0201KT8 ASLD0201T8 | ASD0213T8 ASD0213KT8 ASLD0213T8 | ASD0224T8 ASD0224KT8 ASLD0224T8 |

Contact Arrangement Chart: 3-Position Selector Switches

| Style | | Mounting Position | Operator Position | | | Contact Block Part Number | Description | Operator Part Number | | | | |
|------------|----------------|-------------------|-------------------|-----|----------|------------------------------------|---------------------------------------|---------------------------------------|---------------------------------------|---------------------------------------|---------------------------------------|-------------------------|
| Contact | Circuit Number | | L | C | R | | | Maintained | Spring Return from Right | Spring Return from Left | Two-Way | |
| | | | | | | | | | | | | |
| 1NO 1NC | 202 | 1 | X | 0 | 0 | HW-U10-F | Knob/Lever Key | ASD0302T8 ASD0302KT8 | ASD0314T8 ASD0314KT8 | ASD0323T8 ASD0323KT8 | ASD0335T8 ASD0335KT8 | |
| | | 2 | X—X | 0 | 0 | HW-U01-F | Illuminated Knob | ASLD0302T8 | ASLD0314T8 | ASLD0323T8 | ASLD0335T8 | |
| | 203 | 1 | 0 | X—X | 0 | HW-U01-F | Knob/Lever Key | ASD0302T8 ASD0302KT8 | ASD0314T8 ASD0314KT8 | ASD0323T8 ASD0323KT8 | ASD0335T8 ASD0335KT8 | |
| | | 2 | 0 | 0 | X | HW-U10-F | Illuminated Knob | ASLD0302T8 | ASLD0314T8 | ASLD0323T8 | ASLD0335T8 | |
| | 302 | 1 | X | 0 | X | HW-U10-F | Knob/Lever Key | ASD0306T8 ASD0306KT8 | ASD0310T8 ASD0301KT8 | ASD0328T8 ASD0328KT8 | ASD0339T8 ASD0339KT8 | |
| | | 2 | X—X | 0 | 0 | HW-U01-F | Illuminated Knob | ASLD0306T8 | ASLD310T8 | ASLD0328T8 | ASLD0339T8 | |
| | 303 | 1 | 0 | X | 0 | HW-U01-F | Knob/Lever Key | ASD0306T8 ASD0306KT8 | ASD0310T8 ASD0301KT8 | ASD0328T8 ASD0328KT8 | ASD0339T8 ASD0339KT8 | |
| | | 2 | 0 | 0 | X | HW-U10-F | Illuminated Knob | ASLD0306T8 | ASLD310T8 | ASLD0323T8 | ASLD0339T8 | |
| | 2NO | N/D | 1 | X | 0 | 0 | HW-U10-F | Knob/Lever Key | ASD0302T8 ASD0302KT8 | ASD0314T8 ASD0314KT8 | ASD0323T8 ASD0323KT8 | ASD0335T8 ASD0335KT8 |
| | | | 2 | 0 | 0 | X | HW-U10-F | Illuminated Knob | ASLD0302T8 | ASLD0314T8 | ASLD0323T8 | ASLD0335T8 |
| 301 | | 1 | X | 0 | X | HW-U10-F | Knob/Lever Key | ASD0306T8 ASD0306KT8 | ASD0310T8 ASD0301KT8 | ASD0328T8 ASD0328KT8 | ASD0339T8 ASD0339KT8 | |
| | | 2 | 0 | 0 | X | HW-U10-F | Illuminated Knob | ASLD0306T8 | ASLD310T8 | ASLD0328T8 | ASLD0339T8 | |
| 2NC | 304 | 1 | 0 | X | 0 | HW-U01-F | Knob/Lever Key | ASD0306T8 ASD0306KT8 | ASD0310T8 ASD0301KT8 | ASD0328T8 ASD0328KT8 | ASD0339T8 ASD0339KT8 | |
| | | 2 | X—X | 0 | 0 | HW-U01-F | Illuminated Knob | ASLD0306T8 | ASLD310T8 | ASLD0328T8 | ASLD0339T8 | |
| | N/D | 1 | 0 | X—X | 0 | HW-U01-F | Knob/Lever Key | ASD0302T8 ASD0302KT8 | ASD0314T8 ASD0314KT8 | ASD0323T8 ASD0323KT8 | ASD0335T8 ASD0335KT8 | |
| | | 2 | X—X | 0 | 0 | HW-U01-F | Illuminated Knob | ASLD0302T8 | ASLD0314T8 | ASLD0323T8 | ASLD0335T8 | |
| 2NO 2NC | N/D | 1 | X | 0 | 0 | HW-U10-F | Knob/Lever Key Illuminated Knob | ASD0302T8 ASD0302KT8 ASLD0302T8 | ASD0314T8 ASD0314KT8 ASLD0314T8 | ASD0323T8 ASD0323KT8 ASLD0323T8 | ASD0335T8 ASD0335KT8 ASLD0335T8 | |
| | | 2 | 0 | 0 | X | HW-U10-F | | | | | | |
| | | 3 | 0 | X—X | 0 | HW-U01-F | | | | | | |
| | | 4 | X—X | 0 | 0 | HW-U01-F | | | | | | |
| | 210 | 1 | 0 | X—X | 0 | HW-U01-F | Knob/Lever Key Illuminated Knob | ASD0302T8 ASD0302KT8 ASLD0302T8 | ASD0314T8 ASD0314KT8 ASLD0314T8 | ASD0323T8 ASD0323KT8 ASLD0323T8 | ASD0335T8 ASD0335KT8 ASLD0335T8 | |
| | | 2 | 0 | 0 | X | HW-U10-F | | | | | | |
| | | 3 | 0 | X—X | 0 | HW-U01-F | | | | | | |
| | | 4 | 0 | 0 | X | HW-U10-F | | | | | | |
| | 308 | 1 | X | 0 | X | HW-U10-F | Knob/Lever Key Illuminated Knob | ASD0306T8 ASD0306KT8 ASLD0306T8 | ASD0310T8 ASD0301KT8 ASLD310T8 | ASD0328T8 ASD0328KT8 ASLD0328T8 | ASD0339T8 ASD0339KT8 ASLD0339T8 | |
| | | 2 | X—X | 0 | 0 | HW-U01-F | | | | | | |
| | | 3 | X | 0 | X | HW-U10-F | | | | | | |
| | | 4 | X—X | 0 | 0 | HW-U01-F | | | | | | |
| | 309 | 1 | X | 0 | X | HW-U10-F | Knob/Lever Key Illuminated Knob | ASD0306T8 ASD0306KT8 ASLD0306T8 | ASD0310T8 ASD0301KT8 ASLD310T8 | ASD0328T8 ASD0328KT8 ASLD0328T8 | ASD0339T8 ASD0339KT8 ASLD0339T8 | |
| | | 2 | X—X | 0 | 0 | HW-U01-F | | | | | | |
| | | 3 | 0 | X | 0 | HW-U01-F | | | | | | |
| | | 4 | 0 | 0 | X | HW-U10-F | | | | | | |
| 310 | 1 | 0 | X | 0 | HW-U01-F | Knob/Lever Key Illuminated Knob | ASD0306T8 ASD0306KT8 ASLD0306T8 | ASD0310T8 ASD0301KT8 ASLD310T8 | ASD0328T8 ASD0328KT8 ASLD0328T8 | ASD0339T8 ASD0339KT8 ASLD0339T8 | | |
| | 2 | 0 | 0 | X | HW-U10-F | | | | | | | |
| | 3 | 0 | X | 0 | HW-U01-F | | | | | | | |
| | 4 | 0 | 0 | X | HW-U10-F | | | | | | | |

1. Each operator sub-assembly is available as an "02" and an "06" for 3-position selector switches. The internal cam of an "02" is different from that of an "06". This results in designated combinations of open and closed contacts in the various operator positions.
2. N/D = No circuit number designation required in assembled part number.
3. X = On (closed contacts) 0 = Off (open contacts). X—X Overlapping contacts remain on (closed) when switch is moved between these two positions.

Contact Arrangement Chart: 3-Position Selector Switches

| Style | | Mounting Position | Operator Position | | | Contact Block Part Number | Description | Operator Part Number | | | |
|---------|----------------|-------------------|-------------------|---|---|---------------------------|------------------|---------------------------------------|---------------------------------------|---------------------------------------|--|
| Contact | Circuit Number | | L | C | R | | | Maintained | Spring Return from Right | Spring Return from Left | Two-Way |
| | | | | | | | | | | | |
| 4NO | N/D | 1 | X | 0 | 0 | HW-U10-F | | | | | |
| | | 2 | 0 | 0 | X | HW-U10-F | Knob/Lever Key | ASD0302T8 ASD0302KT8 ASLD0302T8 | ASD0314T8 ASD0314KT8 ASLD0314T8 | ASD0323T8 ASD0323KT8 ASLD0323T8 | ASD0335T8 ASD0335KT8 ASD0335T8 |
| | | 3 | X | 0 | 0 | HW-U10-F | Illuminated Knob | | | | |
| | | 4 | 0 | 0 | X | HW-U10-F | | | | | |
| | 305 | 1 | X | 0 | X | HW-U10-F | | | | | |
| | | 2 | 0 | 0 | X | HW-U10-F | Knob/Lever Key | ASD0306T8 ASD0306KT8 ASLD0306T8 | ASD0310T8 ASD0301KT8 ASLD0310T8 | ASD0328T8 ASD0328KT8 ASLD0328T8 | ASD0339T8 ASD0339KT8 ASLD0339T8 |
| | | 3 | X | 0 | X | HW-U10-F | Illuminated Knob | | | | |
| | | 4 | 0 | 0 | X | HW-U10-F | | | | | |
| 4NC | N/D | 1 | 0 | X | X | HW-U01-F | | | | | |
| | | 2 | X | X | 0 | HW-U01-F | Knob/Lever Key | ASD0302T8 ASD0302KT8 ASLD0302T8 | ASD0314T8 ASD0314KT8 ASLD0314T8 | ASD0323T8 ASD0323KT8 ASLD0323T8 | ASD0335T8 ASD0335KT8 ASD0335T8 |
| | | 3 | 0 | X | X | HW-U01-F | Illuminated Knob | | | | |
| | | 4 | X | X | 0 | HW-U01-F | | | | | |
| | 314 | 1 | 0 | X | 0 | HW-U01-F | | | | | |
| | | 2 | X | X | 0 | HW-U01-F | Knob/Lever Key | ASD0306T8 ASD0306KT8 ASLD0306T8 | ASD0310T8 ASD0301KT8 ASLD0310T8 | ASD0328T8 ASD0328KT8 ASLD0328T8 | ASLD0339T8 ASD0339KT8 ASLD0339T8 |
| | | 3 | 0 | X | 0 | HW-U01-F | Illuminated Knob | | | | |
| | | 4 | X | X | 0 | HW-U01-F | | | | | |

- Each operator sub-assembly is available as an "02" and an "06" for 3-position selector switches. The internal cam of an "02" is different from that of an "06". This results in designated combinations of open and closed contacts in the various operator positions.
- N/D = No circuit number designation required in assembled part number.
- X = On (closed contacts) 0 = Off (open contacts). X-X Overlapping contacts remain on (closed) when switch is moved between these two positions.

Operator Truth Tables

Use the following tables to build custom selector switches.

2 Position Selector Switches

| | Contact | Mounting Position | Operator Position | |
|------------|-------------------|-------------------|-------------------|-------|
| | | | Left | Right |
| ASLD0201T8 | HW-U10-F (NO) | L | 0 | X |
| | | R | 0 | X |
| | HW-U01-F (NC) | L | X | 0 |
| | | R | X | 0 |
| | HW-U10R-F (NO-EM) | L | 0 | X-X |
| | | R | 0 | X-X |
| | HW-U01R-F (NC-LB) | L | X-X | 0 |
| | | R | X-X | 0 |

3 Position Selector Switches

| | Contact | Mounting Position | Operator Position | | |
|---------------------------------------|-------------------|-------------------|-------------------|--------|-------|
| | | | Left | Center | Right |
| ASD0302T8 ASLD0302T8 ASD0302KT8 | HW-U10-F (NO) | L | X | 0 | 0 |
| | | R | 0 | 0 | X |
| | HW-U01-F (NC) | L | 0 | X-X | 0 |
| | | R | X-X | 0 | 0 |
| | HW-U10R-F (NO-EM) | L | X | 0 | 0 |
| | | R | 0 | 0 | X |
| | HW-U10R-F (NC-LB) | L | 0 | X-X | 0 |
| | | R | X-X | 0 | 0 |

| | Contact | Mounting Position | Operator Position | | |
|---------------------------------------|-------------------|-------------------|-------------------|--------|-------|
| | | | Left | Center | Right |
| ASD0306T8 ASLD0306T8 ASD0306KT8 | HW-U10-F (NO) | L | X | 0 | X |
| | | R | 0 | 0 | X |
| | HW-U01-F (NC) | L | 0 | X | 0 |
| | | R | X-X | 0 | 0 |
| | HW-U10R-F (NO-EM) | L | X | 0 | X |
| | | R | 0 | 0 | X |
| | HW-U01R-F (NC-LB) | L | 0 | X | 0 |
| | | R | X-X | 0 | 0 |

Accessories — TWND Series

| Item | Appearance | Description/Usage | Part Number |
|----------------------|---|--|-------------|
| Lamp Removal Tool |  | Rubber tool used to install or remove LED's | OR-55 |
| Metal Bezel |  | Standard octagonal units (chrome-pl.). | OG-81 |
| | | Extended, non-illuminated (chrome-pl.). | OG-82 |
| | | Extended, illuminated (chrome-pl.). | OG-83L |
| | | Jumbo Mushroom Shallow Shroud | ABN4G |
| | | Jumbo Mushroom Deep Shroud | ABN4F |
| Plastic Bezel |  | Black plastic locking ring/bezel | OGP11B |
| Boot/Cover |  | In place of ⊕, specify Neoprene Rubber Boot color: B (black), G (green), R (red), Y (yellow) | OC-11 ⊕ |
| | | Flush units (clear plastic -40° to +60°C). | OC-121 |
| | | Extended units (clear plastic -40° to +60°C). | OC-122 |
| Anti-Rotation Ring |  | Plastic washer For nameplates or panels that should not be scratched. | OGL-D1T |
| | | Thrust washer/Anti-rotation ring for use with notched panel cutout. | OGL-D1S |
| Mounting Hole Plug |  | Plastic with locking nut attached. | OBP-11 |
| | | Metal with locking nut attached | OB-11 |
| | | Grey rubber (-5° to +60°C) | OB-13 |
| Terminal Tab Adaptor |  | Tab #250 17/64" x 3/64" (6.35mm x 0.8mm); Single tab | TW-FA4 |
| Long Lamp Holder |  | Used with Transformer and two contact blocks Used with Full Voltage Adaptor and two contact blocks | TW-LH2 |
| Lead Holder |  | Used with TW-LH2 holder when using four contact blocks | HW-LH3 |
| Lock Out Adaptor |  | Used to provide lockout protection for TWTD pushbuttons and knob selectors. ø 1-13/64" (30mm) | OL-KL1 |
| Full Voltage Clips |  | Primary Voltage (50/60Hz) Required for all full voltage pilot lights. Two pieces each. 2 clips required for full voltage pilot lights. | APD-F |
| Replacement Keys |  | Pair of keys (#0) | TW-SK |

Switches & Pilot Devices

Signaling Lights

Relays & Sockets

Timers

Contactors



Terminal Blocks

Circuit Breakers

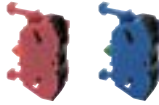
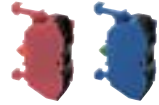
Accessories TWND Series continued

| Item | Appearance | Description/Usage | Part Number | |
|--|---|--|---|---|
| | | | 1NC | 1NO |
| Contact Blocks (with side entry) |  | These contacts are applicable for wires terminated by ring, fork, terminals, not recommended for bare wire connections. | HW-U01 HW-U01-MAU HW-U01R HW-U01R-MAU (with side entry) | HW-U10 HW-U10-MAU HW-U10R HW-U10R-MAU (with side entry) |
| Contact Blocks (without side entry) |  | These contacts are applicable for wires terminated by ring, fork, or ferule terminals, and also bare wire connections. | HW-U01-F HW-U01-MAU-F HW-U01R-F HW-U01R-MAU-F (no side entry) | HW-U10-F HW-U10-MAU-F HW-U10R-F HW-U10R-MAU-F (no side entry) |

Fingersafe Covers for TWND Series

| Item | Description | Used with | Part Number |
|--|---|---------------------------|-------------|
|  | Fingersafe terminal cover, for full voltage pilot lights, adds 3mm to overall depth | Full voltage pilot lights | APD-PVL |
|  | Fingersafe terminal cover, adds 1.5mm to overall depth | Transformer pilot lights | N-VL3 |

Nameplates – TWND Series

Faceplates

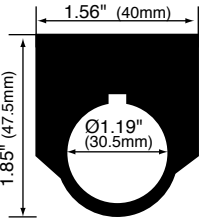
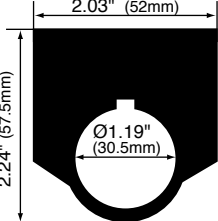
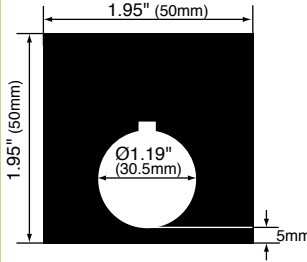
| | NALD | NAKD | NAQD |
|----------------------|---|---|--|
| Dimensions |  |  |  |
| Description | Part Number | | |
| Nameplate (blank) | NALD-B (black) NALD-R (red) | NAKD-B (black) NAKD-R (red) | NAQD-B (black) NAQD-R (red) |
| Nameplate (engraved) | NALD-① | NAKD-① | NAQD-① |

1. Nameplates are made of 0.031" aluminum. Lettering is white letters engraved on black background.
2. In place of ①, insert either the standard legend code from table below or custom engraving delimited by " ".

Standard Legend Codes

| Legend | Pushbuttons | | Pushbuttons/Selector Switches | | | | Selector Switches | | |
|-------------|-------------|---------------|-------------------------------|-------------|------|------------|-------------------|-------------------|------|
| | Code | Legend | Code | Legend | Code | Legend | Code | Legend | Code |
| AUTO | 101 | OPEN | 116 | AUTO-MAN | 201 | | | AUTO-MAN-OFF | 301 |
| CLOSE | 102 | OUT | 117 | CLOSE-OPEN | 202 | | | AUTO-OFF-MAN | 302 |
| DOWN | 103 | RAISE | 118 | DOWN-UP | 203 | | | CLOSE-OFF-OPEN | 303 |
| EMERG.STOP* | 104 | RESET | 119 | FAST-SLOW | 204 | | | DOWN-OFF-SLOW | 304 |
| FAST | 105 | REVERSE | 120 | FOR-REV | 205 | REV-FOR | 216 | FAST-OFF-SLOW | 305 |
| FORWARD | 106 | RUN | 121 | HAND-AUTO | 206 | RUN-JOG | 217 | FOR-OFF-REV | 306 |
| HAND | 107 | SLOW | 122 | HIGH-LOW | 207 | RUN-SAFE | 218 | LEFT-OFF-RIGHT | 307 |
| HIGH | 108 | START | 123 | JOG-RUN | 208 | SAFE-RUN | 219 | LOWER-OFF-RAISE | 308 |
| IN | 109 | STOP* | 124 | LEFT-RIGHT | 209 | SLOW-FAST | 220 | OFF-MAN-AUTO | 309 |
| INCH | 110 | STOP | 125 | LOWER-RAISE | 210 | START-STOP | 221 | OFF-SLOW-FAST | 310 |
| JOG | 111 | TEST | 126 | MAN-AUTO | 211 | STOP-START | 222 | OFF-1-2 | 311 |
| LOW | 112 | UP | 127 | OFF-ON | 212 | UP-DOWN | 223 | OPEN-OFF-CLOSE | 312 |
| LOWER | 113 | I (Int'l On) | 150 | ON-OFF | 213 | | | SLOW-OFF-FAST | 313 |
| OFF | 114 | O (Int'l Off) | 151 | OPEN-CLOSE | 214 | | | SUMMER-OFF-WINTER | 314 |
| ON | 115 | EMO | 152 | RAISE-LOWER | 215 | | | UP-OFF-DOWN | 315 |
| | | | | | | | | 1-OFF-2 | 316 |
| | | | | | | | | HAND-OFF-AUTO | 317 |

1. *Available in Red as standard legend code 104 and 124. To order engraved nameplate and codes, add legend code to nameplate part number. Character height based on the number of characters, space and size of nameplate. Standard character size is 3/16".
2. Nameplates with standard legends are the same list price as blank nameplates. Special engravings, additional cost.

To specify engraving instructions, use the Nameplate order form on next page.

Custom engraved Nameplates Order Form – TWND Series

Copy this order form and use it to specify Letter Height, Custom Engravings, Location of Engraving on Nameplate, and Quantity Desired.

To ensure engraving accuracy, fax it to your IDEC representative. or Distributor.

Your Company Name: _____

IDEC Rep/Distributor Contact: _____

Your Name: _____

PO number (if known): _____

Telephone: _____

IDEC Rep/Distributor Phone: _____

Fax & Email: _____

IDEC Rep/Distributor Fax & Email: _____

NALD Nameplate

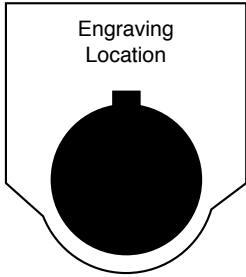

Step 1.

Choose Letter Size - 7/64" or 1/8".

Check the box for the letter size you want. Then write your lettering in box below checkboxes. Note: 1/8" size letters cannot exceed 13 characters.

Sample Letter Sizes

7/64" Letters: A B C D

1/8" Letters: A B C D

7/64"
Letter Size

16 characters max
(for 7/64" size letters)

1/8"
Letter Size

13 characters max
(for 1/8" size letters)

Step 2.

Specify Quantity.

Enter the number of nameplates desired in the box on the right.

Qty

| | | | | | | | | | | | | | | | | | | | |
|---|---|---|---|---|---|---|---|---|----|----|----|----|----|----|----|--|--|--|--|
| | | | | | | | | | | | | | | | | | | | |
| 1 | 2 | 3 | 4 | 5 | 6 | 7 | 8 | 9 | 10 | 11 | 12 | 13 | 14 | 15 | 16 | | | | |

NAKD Nameplate

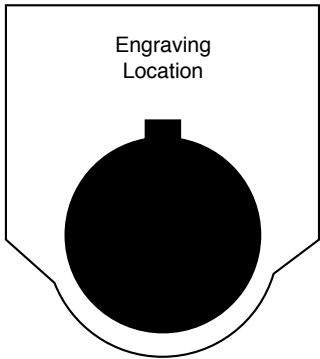

Step 1.

Choose Letter Size - 7/64" or 1/8".

Check the box for the letter size you want. Then write your lettering in box below checkboxes. Note: 1/8" size letters cannot exceed 9 characters.

Step 2.

Specify Quantity.

Enter the number of nameplates desired in the box on the right.

Qty

| | | | | | | | | | | | | | | | | | | | |
|---|---|---|---|---|---|---|---|---|----|----|----|----|----|----|----|----|--|--|--|
| | | | | | | | | | | | | | | | | | | | |
| 1 | 2 | 3 | 4 | 5 | 6 | 7 | 8 | 9 | 10 | 11 | 12 | 13 | 14 | 15 | 16 | 17 | | | |

Sample Letter Sizes

1/8" Letters: A B C D

NAQD Nameplate

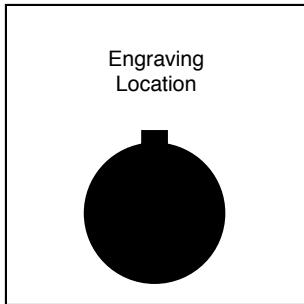

Step 1.

Choose Letter Size - 7/64" or 1/8".

Check the box for the letter size you want. Then write your lettering in box below checkboxes.

Note: 1/8" size letters cannot exceed 16 characters.

7/64"
Letter Size

20 characters max
(for 7/64" size letters)

1/8"
Letter Size

16 characters max
(for 1/8" size letters)

Step 2.

Specify Quantity.

Enter the number of nameplates desired in the box on the right.

Qty

| | | | | | | | | | | | | | | | | | | | |
|---|---|---|---|---|---|---|---|---|----|----|----|----|----|----|----|----|----|----|----|
| | | | | | | | | | | | | | | | | | | | |
| 1 | 2 | 3 | 4 | 5 | 6 | 7 | 8 | 9 | 10 | 11 | 12 | 13 | 14 | 15 | 16 | 17 | 18 | 19 | 20 |

Sample Letter Sizes

3/32" Letters: A B C D

1/8" Letters: A B C D

Switches & Pilot Devices

Signaling Lights

Relays & Sockets

Timers

Contactors

Terminal Blocks

Circuit Breakers

Switch Engraving Order Form – TWND Series

Copy this order form and use it to specify Letter Height, Maximum Number of Lines and Text to be engraved.

To insure engraving accuracy, fax it to your IDEC representative or Distributor.

Your Company: _____
 Name: _____
 Address: _____
 PO: _____

Telephone: _____
 Fax: _____
 Email: _____
 Part Number to be Engraved: _____

Please check one of the boxes below to indicate your choice of engraving options:



ø29mm, ø40mm Mushroom Head

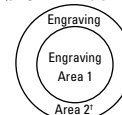

| | # of Lines | Letter Height | Max. Characters Per Line |
|--------------------------|------------|---------------|--------------------------|
| <input type="checkbox"/> | 1 | 5/32 | 7 |
| <input type="checkbox"/> | | 1/8 | 8 |
| <input type="checkbox"/> | 2 | 5/32 | 7 |
| <input type="checkbox"/> | | 1/8 | 8 |
| <input type="checkbox"/> | 3 | 1/8 | 8 |
| <input type="checkbox"/> | 4 | Custom* | |

| | # of Lines | Letter Height | Max. Characters Per Line |
|--------------------------|------------|---------------|--------------------------|
| <input type="checkbox"/> | 1 | 3/4 | 4 |
| <input type="checkbox"/> | | 5/16 | 5 |
| <input type="checkbox"/> | 2 | 5/16 | 5 |
| <input type="checkbox"/> | | 1/4 | 6 |
| <input type="checkbox"/> | | 5/32 | 8 |
| <input type="checkbox"/> | 3 | 5/32 | 8 |
| <input type="checkbox"/> | | 1/8 | 9 |
| <input type="checkbox"/> | 4 | 1/8 | 9 |

| | # of Lines | Letter Height | Max. Characters Per Line |
|--------------------------|------------------|---------------|--------------------------|
| <input type="checkbox"/> | Engraving Area 1 | 5/32 | 5 |
| <input type="checkbox"/> | | 1/8 | 5 |
| <input type="checkbox"/> | Engraving Area 2 | 5/32 | 7 |
| <input type="checkbox"/> | | 1/8 | 7 |

- 1. Above mentioned specifications hold true for standard size push-buttons (round and square).
- 2. *Engraving Area 2 can be engraved for 40mm mushroom head non-illuminated pushbutton only.
- 3. Engraving is done on the button itself for non-illuminated push buttons and on marking plate for illuminated push buttons and pilot lights.
- 4. Please enter text exactly how you want it engraved, take care to emphasize capital or small letters.



| | # of Lines | Letter Height | Max. Characters Per Line |
|--------------------------|------------|---------------|--------------------------|
| <input type="checkbox"/> | 1 | 5/32 | 7 |
| <input type="checkbox"/> | | 1/8 | 8 |
| <input type="checkbox"/> | 2 | 5/32 | 7 |
| <input type="checkbox"/> | | 1/8 | 8 |
| <input type="checkbox"/> | 3 | 1/8 | 8 |
| <input type="checkbox"/> | 4 | Custom* | |

*Engraving is possible, but character size will be smaller than standard sizes.

Enter text to be engraved:

Line 1: _____
 Line 2: _____
 Line 3: _____
 Line 4: _____

Sample Letter Sizes

1/8 Letters: **OPEN**

5/32 Letters: **OPEN**

All engraving is 5/8mm wide.

For IDEC Internal Use Only:

Work Order #: _____

Dimensions (mm)

Pushbutton

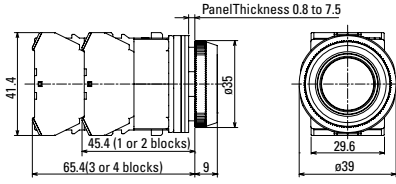

| Pushbuttons | Dimension A | Dimension B |
|---|-----------------------------------|----------------------------------|
| Flush | 0.351" (9mm) | ø 0.975" (25mm) |
| Extended | 0.566" (14.5mm) | ø 0.975" (25mm) |
| Extended w/Full Shroud | 0.663" (17mm) | ø 1.11" (28.5mm) |
| Mushroom | 0.858" (22mm) | ø 1.56" (40mm) |
| Mushroom w/Full Shroud | 0.936" (24mm) | ø 1.87" (48mm) |
| Jumbo Mushroom | 1.13" (29mm) | ø 2.54" (65mm) |
| Mushroom, Pushlock Turn Reset and Push-Pull | *0.975" (25mm) **0.975" (25mm) | ø 1.56" (40mm) ø 1.56" (40mm) |

Mushroom Pushbutton w/Full Shroud

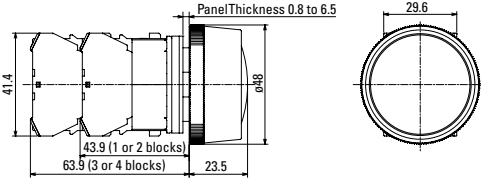

*Dimension when operator is in reset position.
**Dimension when operator is in pull position.

Illuminated Pushbuttons

w/Transformer

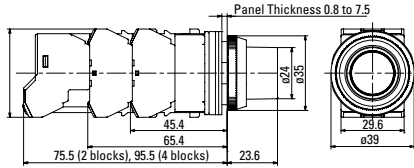

Full Voltage

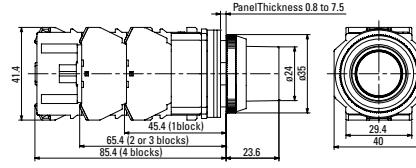

| Illuminated Pushbuttons | Dimension A | Dimension B |
|--|-----------------------------------|------------------------------------|
| Flush w/Full Shroud | 0.975" (25mm) 0.995" (25.5mm) | ø 0.936" (24mm) ø 0.936" (24mm) |
| Extended w/Full Shroud | 0.741" (19mm) 0.761" (19.5mm) | ø 0.936" (24mm) ø 0.936" (24mm) |
| ø 1.56" (40mm) Mushroom Pushlock Turn Reset, Push-Pull | *0.975" (25mm) **0.975" (25mm) | ø 1.56" (40mm) ø 1.56" (40mm) |



*Dimension when operator is in reset position.
**Dimension when operator is in pull position.

Pilot Lights

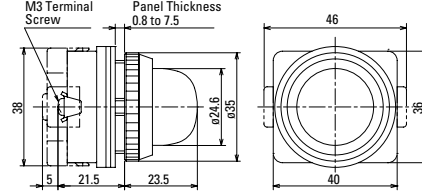

Selector Switches

Knob

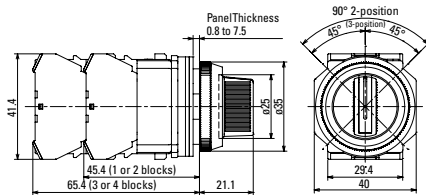

Lever

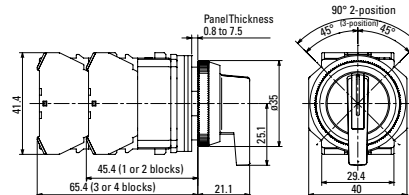

Key

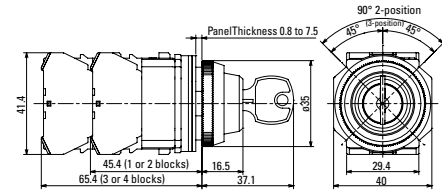

Illuminated Knob

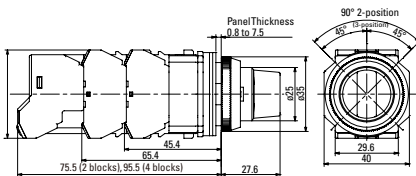

Selector Switches Panel Cut-Out

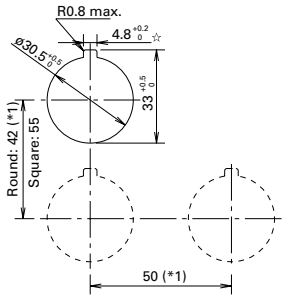

1. *Jumbo Mushroom < 2.61" (66mm)
2. Minimum mounting centers are applicable to switches with one stack of contact blocks. When mounting two stacks of contact blocks, minimum centers should allow for access to wiring.
3. The ø 0.195" (ø 5mm) recess is necessary when either the nameplate or anti-rotation ring is used.

Illuminated Selector Switches

OL-KL1
Lock-Out Adaptor

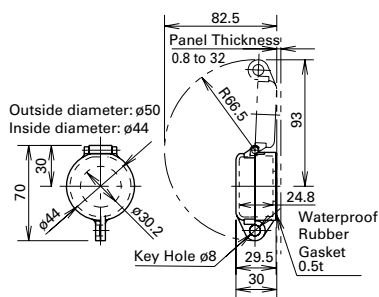

OC-31
Pushbutton Clear Boot

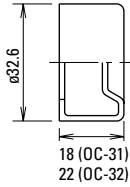

OGL-31
Anti-Rotation Ring

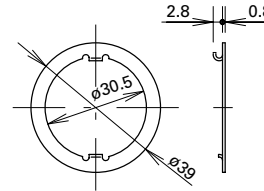

OB-31
Mounting Hole Rubber Plug

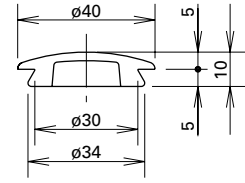

Finger-Safe Cover

N-VL3

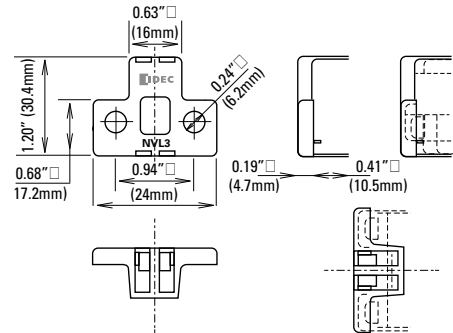

APD-PVL

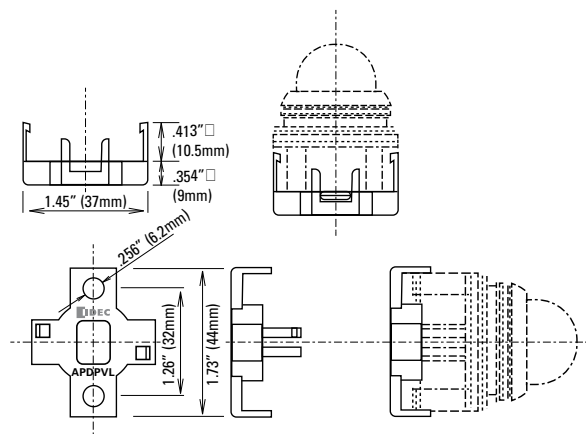

Operating Instructions

Adjustment for Panel Thickness

Each unit is shipped with several waterproof gaskets which are 0.06" (1.5mm) and 0.12" (3mm) thick. Combine the gaskets for a dimension approximately equal to panel thickness and install between the bezel and the body of the unit.

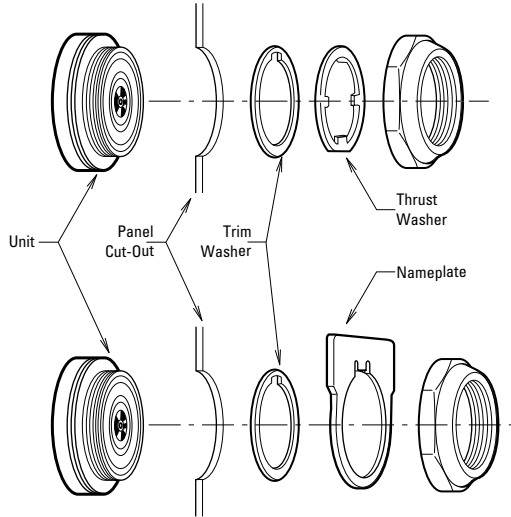

A trim washer must be used with a thrust washer or a nameplate to prevent the control unit from rotating in the mounting hole. When using anti-rotation rings (trim washer with thrust washer or nameplate), install as shown below.

Selector Switches

The operator shaft of each unit has a recess to identify in which direction to install the handle. Align the handle with the recess. Press color insert (TW-HC1) into the Standard Operating Positions.

Standard Operation Positions

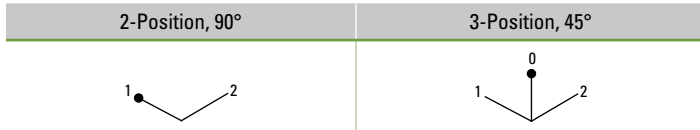

Non-Illuminated 3-Position Operators

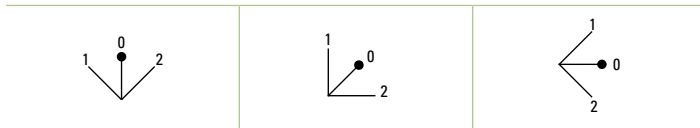

Installation of LED Illuminated Units

Transformer units are recommended for use in areas subjected to inductive noise.

Application Example For Push-To-Test Pilot Light

A typical application of illuminated pushbuttons is a push-to-test pilot light which can be used to check the lamp/LED circuit.

Transformer/AC-Adapter Circuit

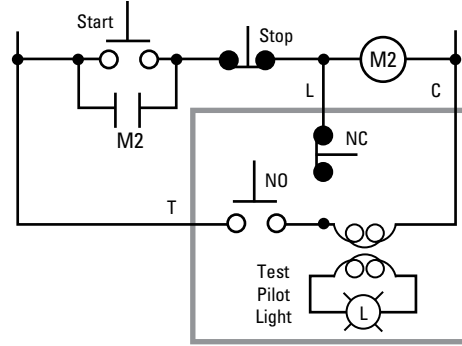

Full Voltage Circuit

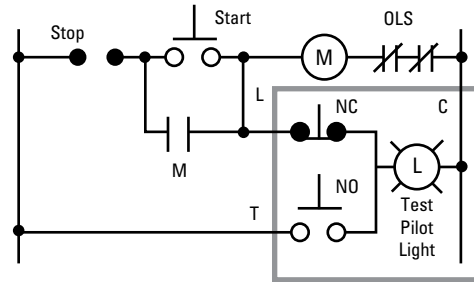

X-ON Electronics

Largest Supplier of Electrical and Electronic Components

Click to view similar products for [Industrial Panel Mount Indicators / Switch Indicators](#) category:

Click to view products by [Idec](#) manufacturer:

Other Similar products are found below :

[LW1A-P1-W](#) [LW1B-A0L](#) [01-952.0](#) [01-152.025](#) [D38999/20FJ29PB L/C](#) [704-6012](#) [704-6020](#) [704-6023](#) [704-6026](#) [73.362.4028.0](#) [EUS-704.000.7](#) [750-1520](#) [9001OA120](#) [99-450.837](#) [99-455.837](#) [99-486.837](#) [99-901.9](#) [99-902.9](#) [99-908.0](#) [99-909.4](#) [99-909.5](#) [A0244J1](#) [A3DT-500Y](#) [AL6M-P7P-A](#) [AOLQW-2B0600](#) [AP1M255-A](#) [APD106LN-A](#) [APD106LN-G](#) [APN1126-G](#) [APS122DN-W](#) [ATN2100](#) [AYLW4L-A](#) [18-237.035](#) [C0180AANAHA](#) [HW1A-L1-GD](#) [HW1A-P2-GL](#) [HW1F-3G](#) [HW1R-2DF20-R](#) [HW1X-BM411-R](#) [HW2A-L1-GL](#) [HW2A-P1-GD](#) [HW4S-31L](#) [HWAZ1N-OB](#) [PA2200/1](#) [PA2SHIELD](#) [21-931.0](#) [21-931.2](#) [96-923.5](#) [1625006](#) [99-451.837](#)