

New TWND Series – Full Size NEMA Pushbuttons

**New! TWND Series: Heavy duty switches built to last****Key features:**

- Variety of button sizes up to 2 9/16" (65mm)
- Rugged construction includes chrome plated zinc locking ring die cast zinc mounting thread
- LED illumination
- Transformer or full voltage
- Slow make, double break wiping contacts
- Modular construction for maximum flexibility
- Available assembled or as sub-components
- UL Type 4X, 13 and IP65 watertight/oiltight panel

The rugged series of TWND switches offers both variety and durability in an attractive design.

With button sizes up to 2 9/16" (65mm), chrome plated zinc locking rings, die cast zinc mounting threads, steel anti-rotation rings, and self cleaning contacts, the TWNDs are here to stay.

The TWND series also offers LED illumination in full voltage and transformer models.

Regardless of your switching needs, the NEW TWND series provides the kind of long lasting, industrial strength quality you've come to expect from IDEC.



Switches & Pilot Devices

Signaling Lights

Relays & Sockets

Timers

Contactors

Terminal Blocks

Circuit Breakers

Specifications

Conforming to Standards	EN60947-5-1, UL508, CSA C22-2 No.14
Approvals	CSA: pushbuttons and selector switches: A600 pilot lights and illuminated pushbuttons, direct supply pilot lights and illuminated pushbuttons with integral transformer (100/110, 115, 120, 200/220, 230, 240, 380, 400/440, 480V) UL: pushbuttons and selector switches: A600 pilot lights and illuminated pushbuttons, direct supply pilot lights and illuminated pushbuttons with integral transformer (100/110, 115, 120, 200/220, 230, 240, 380, 400/440, 480V) TÜV: pushbuttons and selector switches: A600 pilot lights and illuminated pushbuttons, direct supply pilot lights and illuminated pushbuttons with integral transformer (100/110, 115, 120, 200/220, 230, 240, 380, 400/440, 480V)
Operating Temperature	Operation: -25 to +50°C (illuminated versions) -25 ~ +70C non-illuminated Storage: -40 to +80°C (without freezing) C-> °C
Vibration Resistance	5 to 55Hz, 98m/sec ² (10g) conforming to IEC60068-2-6
Shock Resistance	980m/sec ² (100g) conforming to IEC60068-2-27
Electric Shock Protection	Class 2 conforming to IEC60664-1
Degree of Protection	IP65 (from front of the panel) (conforming to IEC60529) UL Type 1, 2, 3, 3R, 3S, 4, 4X, 5, 12, 13 (conforming to NEMA ICS6-110)
Mechanical Life	Momentary pushbuttons: 5,000,000 (1800 operations per hour) All other switches: 500,000
Pollution Degree (conforming to IEC60947-1)	3

Mechanical-Electrical Specifications

Rated Operational Characteristics	AC-15: A600					
Rated Insulation Voltage	600V					
Rated Impulse Withstanding Voltage Dielectric Strength	Between live and dead metal parts 2.5kV AC, 1 minute					
Rated Thermal Current	10 Amp					
Minimum Switching Capacity	5 mA at 3V AC/DC (applicable range may vary with operating conditions and load types)					
Contact Operation	Slow break NC or NO					
Operating Force	Flush and extended pushbuttons—with 1NO or 1NC contact: 6.2±2N (momentary), 9.0±1.5N Additional contacts—1NO or 1NC: +3.0N					
Recommended Terminal Torque	Unit	Wire	Number of Wires	Recommended Tightening Torque (Nm)	Terminal Screw	
	HW-U Contact Block	Crimping Terminal		2	1.0 to 1.3	M3.5
		Solid Wire	ø0.5 to 1.6 mm (AWG14 to 22)	2	1.0 to 1.3	
			ø1.7 to 2.0 mm (AWG12)	1	1.2 to 1.3	
		Stranded Wire	0.3 to 2.0 mm ² (AWG14 to 22)	2	1.0 to 1.3	
	2.1 to 3.5 mm ² (AWG12)		1	1.2 to 1.3		
	Illuminated Unit (*1)	Crimping Terminal		2	1.0 to 1.3	M3.5
		Solid Wire	ø0.5 to 1.6 mm (AWG14 to 22)			
Applicable Wire Size	Pilot Light	Crimping Terminal			0.6 to 1.0 (M3.0)	
		Solid Wire	ø0.5 to 1.6 mm (AWG14 to 22)	2	1.0 to 1.3 (M3.5)	
		Stranded Wire	ø0.3 to 2.0 mm (AWG14 to 22)			
 1. * refers to the lamp terminals of the illuminated push buttons and selector switches.						
Contact Resistance	Initial contact resistance of 50mΩ or less					
Contact Gap	4mm (NO and NC) 2mm (NO-EM and NC-LB)					
LED Ratings	LEDs: 6V: 8mA, 12V: 11mA, 24V: 11mA, 120V: 8.8mA, 240V: 8.6mA					
Contact Material	Silver					

Contact Ratings

Contact Ratings by Utilization Category IEC 60947-5-1	AC-15 (A600)								
	DC-13 (P600)								
Contact Ratings by Utilization Category									
Operational Voltage			24V	48V	50V	110V	220V	440V	
Operation Current	AC 50/60 Hz	AC-12 Control of resistive loads & solid state loads	10A	—	10A	10A	6A	2A	
		AC-15 Control of electromagnetic loads (> 72VA)	10A	—	7A	5A	3A	1A	
	DC	DC-12 Control of resistive loads & solid state loads	10A	5A	—	2.2A	1.1A	—	
		DC-13 Control of electromagnets	5A	2A	—	1.1A	0.6A	—	

Non-Illuminated Pushbuttons (Assembled)

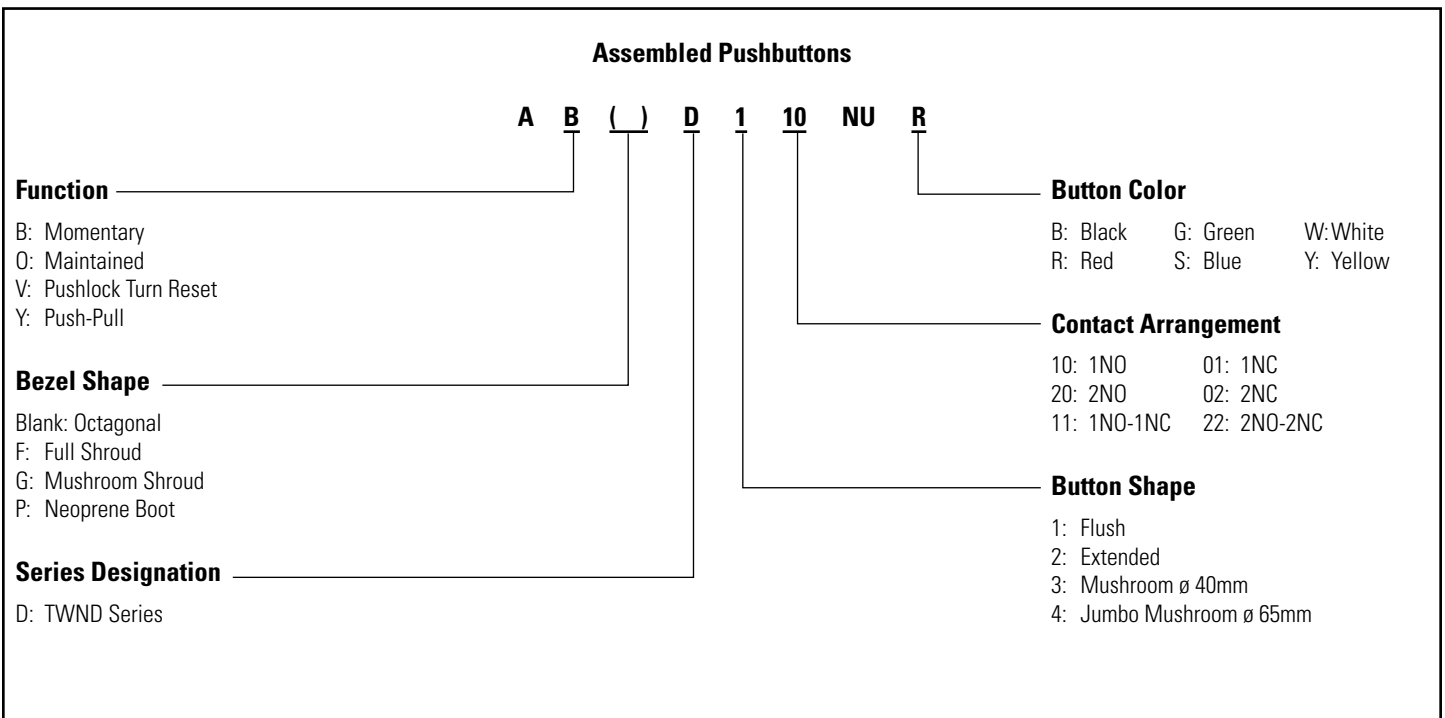

1. Use only when interpreting part numbers. Do not use for developing part numbers.
2. Custom contact configurations available, contact IDEC for details.

Non-Illuminated Pushbuttons (Assembled)

Non-Illuminated Pushbuttons

Style	Contacts	Momentary	Maintained
Flush	1NO	ABD110NUⓄ	AOD110NUⓄ
	1NC	ABD101NUⓄ	AOD101NUⓄ
	1NO-1NC	ABD111NUⓄ	AOD111NUⓄ
	2NO	ABD120NUⓄ	AOD120NUⓄ
	2NC	ABD102NUⓄ	AOD102NUⓄ
Extended	1NO	ABD210NUⓄ	AOD210NUⓄ
	1NC	ABD201NUⓄ	AOD201NUⓄ
	1NO-1NC	ABD211NUⓄ	AOD211NUⓄ
	2NO	ABD220NUⓄ	AOD220NUⓄ
	2NC	ABD202NUⓄ	AOD202NUⓄ
Extended with Neoprene Boot*	1NO	ABPD210NUⓄ	AOPD210NUⓄ
	1NC	ABPD201NUⓄ	AOPD201NUⓄ
	1NO-1NC	ABPD211NUⓄ	AOPD211NUⓄ
	2NO	ABPD220NUⓄ	AOPD220NUⓄ
	2NC	ABPD202NUⓄ	AOPD202NUⓄ
Recessed	1NO	ABFD110NUⓄ	AOFD110NUⓄ
	1NC	ABFD101NUⓄ	AOFD101NUⓄ
	1NO-1NC	ABFD111NUⓄ	AOFD111NUⓄ
	2NO	ABFD120NUⓄ	AOFD120NUⓄ
	2NC	ABFD102NUⓄ	AOFD102NUⓄ
Extended with Full Shroud	1NO	ABFD210NUⓄ	AOFD210NUⓄ
	1NC	ABFD201NUⓄ	AOFD201NUⓄ
	1NO-1NC	ABFD211NUⓄ	AOFD211NUⓄ
	2NO	ABFD220NUⓄ	AOFD220NUⓄ
	2NC	ABFD202NUⓄ	AOFD202NUⓄ
ø 40mm Mushroom Head	1NO	ABD310NUⓄ	AOD310NUⓄ
	1NC	ABD301NUⓄ	AOD301NUⓄ
	1NO-1NC	ABD311NUⓄ	AOD311NUⓄ
	2NO	ABD320NUⓄ	AOD320NUⓄ
	2NC	ABD302NUⓄ	AOD302NUⓄ
ø 40mm Mushroom Head with Full Shroud	1NO	ABGD310NUⓄ	AOGD310NUⓄ
	1NC	ABGD301NUⓄ	AOGD301NUⓄ
	1NO-1NC	ABGD311NUⓄ	AOGD311NUⓄ
	2NO	ABGD320NUⓄ	AOGD320NUⓄ
	2NC	ABGD302NUⓄ	AOGD302NUⓄ
ø 65mm Jumbo Mushroom Head	1NO	ABD410NUⓄ	AOD410NUⓄ
	1NC	ABD401NUⓄ	AOD401NUⓄ
	1NO-1NC	ABD411NUⓄ	AOD411NUⓄ
	2NO	ABD420NUⓄ	AOD420NUⓄ
	2NC	ABD402NUⓄ	AOD402NUⓄ
ø 65mm Jumbo Mushroom Head with Shallow Shroud	1NO	ABGD410NUⓄ	AOGD410NUⓄ
	1NC	ABGD401NUⓄ	AOGD401NUⓄ
	1NO-1NC	ABGD411NUⓄ	AOGD411NUⓄ
	2NO	ABGD420NUⓄ	AOGD420NUⓄ
	2NC	ABGD402NUⓄ	AOGD402NUⓄ
ø 65mm Jumbo Mushroom Head With Deep Shroud	1NO	ABFD410NUⓄ	AOFD410NUⓄ
	1NC	ABFD401NUⓄ	AOFD401NUⓄ
	1NO-1NC	ABFD411NUⓄ	AOFD411NUⓄ
	2NO	ABFD420NUⓄ	AOFD420NUⓄ
	2NC	ABFD402NUⓄ	AOFD402NUⓄ

① Button Color Codes

Color	Code
Black	B
Green	G
Red	R
Blue	S
Yellow	Y
White	W



1. 65mm Jumbo mushroom not available in white.
2. Neoprene boot is not available in blue or white.



1. In place of Ⓞ, specify the Button Color Code.
2. For sub-assembly part numbers, see next page.
3. *Neoprene boot available only in Black (B), Green (G), Red (R) and Yellow (Y).

Non-Illuminated Pushbuttons (Sub-Assembled)

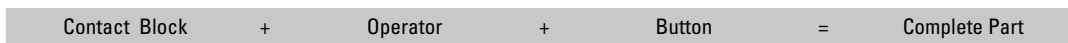

Operators

Style	Image	Part Number	
		Momentary	Maintained
Flush/Extended		ABD1200T8	AOD1200T8
Extended with Full Shroud		ALFD2300T8	AOLFD2300T8
ø 40mm Mushroom/ø 65mm Jumbo Mushroom		ABD3400T8	AOD3400T8
ø 40mm Mushroom with Full Shroud		ABGD-300T	AOGD-300T
ø 65mm Jumbo Mushroom with Shallow Shroud		ABGD-400T	AOGD-400T
ø 65mm Jumbo Mushroom with Deep Shroud		ABFD-400T	AOFD-400T

Buttons and Lenses

Style	Image	Part Number
Flush		ABD1BN-Ⓢ
Extended		ABD2BN-Ⓢ
ø 40mm Mushroom		ABD3BN-Ⓢ
ø 65mm Jumbo Mushroom		ABD4BN-Ⓢ



In place of Ⓢ, specify the Button Color Code. (See table previous page)

Contact Blocks

Style	Image	Part Number	
		1NO	1NC
All Control Units		HW-U10-F HW-U10R-F (early make)	HW-U01-F HW-U01R-F (late break)
Dummy Block		HW-DB	



- Dummy blocks (no contacts) are used with an odd number of contact blocks.
- Combining HW-U10R-F and HW-U01R-F result in overlapping contacts (remain on, or closed, when switch is moved between two positions).

Stop Switches (Assembled)



Assembled Stop Switches

A V (L) D 3 22 11 D NU R

Function

V: Pushlock Turn Reset
Y: Push-Pull

Illumination

Blank: None
L: Illuminated

Series Designation

D: TWND Series

Button/Lens Size

3: 40mm Mushroom

Illumination Circuit

Full Voltage:

66: 6VAC/DC

11: 12VAC/DC

22: 24AC/DC

QH2: 120VAC

QM4: 240VAC

Transformer:

126: 120VAC step down transformer

246: 240VAC step down transformer

486: 480VAC step down transformer

Button/Lens Color Code

A: Amber

G: Green

R: Red

S: Blue

W: White

Y: Yellow

(illuminated units only)

D: LED

Contact Arrangement

10: 1NO 01: 1NC

20: 2NO 02: 2NC

11: 1NO-1NC 22: 2NO-2NC



1. Use only when interpreting part numbers. Do not use for developing part numbers.
2. Custom contact configurations available, contact IDEC for details.

Stop Switches (Assembled)

Stop Switches

Style	Contacts	Part Number
ø 40mm Pushlock Turn Reset 	Non-Illuminated	1NO AVD310NUR* 1NC AVD301NUR* 1NO-1NC AVD311NUR* 2NO AVD320NUR* 2NC AVD302NUR*
	Full Voltage	1NO-1NC AVLD3③11DNUR* 2NO AVLD3③20DNUR* 2NC AVLD3③02DNUR*
ø 40mm Illuminated Pushlock Turn Reset 	Transformer	1NO-1NC AVLD3④11DNUR* 2NO AVLD3④20DNUR* 2NC AVLD3④02DNUR*
	Non-Illuminated	1NO AYD310NU④ 1NC AYD301NU④ 1NO-1NC AYD311NU④ 2NO AYD320NU④ 2NC AYD302NU④
ø 40mm Push-Pull 	Full Voltage	1NO-1NC AYLD3③11DNU② ** 2NO AYLD3③20DNU② ** 2NC AYLD3③02DNU② **
	Transformer	1NO-1NC AYLD3④11DNU② ** 2NO AYLD3④20DNU② ** 2NC AYLD3④02DNU② **

- 1. In place of ④, specify the button color code
- 2. In place of ③, specify the lens color code.
- 3. In place of ②, specify the Full Voltage (lamp voltage) Code.
- 4. * Only available in red.
- 5. In place of ④, specify the transformer voltage code.
- 6. **Not available in blue.
- 7. For sub-assembly part numbers, see next page.
- 8. For nameplates and accessories, see page 769 and page 767.
- 9. For dimensions, see page 772.

① Button Color Codes

Color	Code
Black	B
Green	G
Red	R
Blue	S
Yellow	Y

② Lens Color Codes

Color	Code
Amber	A
Green	G
Red	R
Blue	S
White	W
Yellow	Y

③ Full Voltage Codes

Voltage	Code
6V AC/DC	66
12V AC/DC	11
24V AC/DC	22
120V AC	QH2
240V AC	QM4

④ Transformer Voltage Codes

Voltage	Code
120VAC	126
240VAC	246
480VAC	486

 Transformers step down to 6V.

Stop Switches (Sub-Assembled)

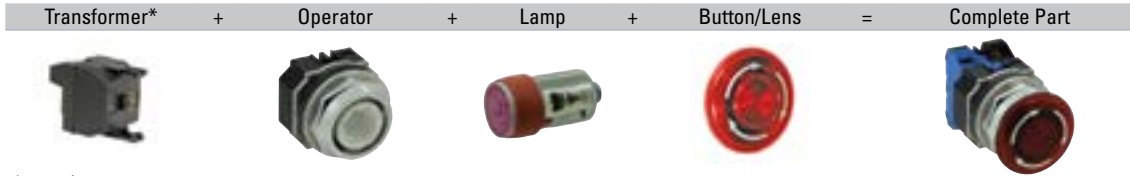

* Not required for full voltage units.

Operators

Style	Image	Part Number
ø40mm Illuminated and Non-illuminated Pushlock Turn Reset		AVD000T8
ø 40mm Illuminated and Non-illuminated Push-Pull		AYD000T8

Buttons and Lenses

Style	Image	Part Number
Button for Pushlock Turn Reset Stop Switches (ø40mm, red only)		AVN3B-R
Lens for Illuminated Pushlock Turn Reset Stop Switches (ø40mm, red only)		AVLN3LU-R
Button for Push-Pull Stop Switches (ø40mm)		AYD3BN-①
Lens for Illuminated Push-Pull Stop Switches (ø40mm)		AYLD3L-②

- ① In place of ①, specify the Button Color Code. (See table below)
- ② In place of ②, specify the LED Color Code.
- ③ *Not available in blue.

Lamp Circuit Components

Style	Application	Part Number
Long Lamp Holder	Used with Full-size Transformer and two contact blocks	TW-LH2
	Used with Full Voltage Adaptor and two contact blocks	
Lead Holder	Used with TW-LH2 holder when using four contact blocks	HW-LH3

Lamps

Style	Voltage	Part Number
LED	6V AC/DC	LSTD-6③
	12V AC/DC	LSTD-1③
	24V AC/DC	LSTD-2③
	120V AC	LSTD-H2③
	240V AC	LSTD-M4③

- ① In place of ②, specify the LED color code.
- ② The LED contains a current-limiting resistor and a protection diode.

① Button Color Codes

Color	Code
Black	B
Green	G
Red	R
Blue	S
Yellow	Y

② Lens Color Codes

Color	Code
Amber	A
Green	G
Red	R
Blue	S
White	W

③ LED Color Codes

Color	Code
Amber	A
Green	G
Red	R
Blue	S
White	W

Contact Blocks

Style	Part Number	
	1NO	1NC
All Control Units	HW-U10-F	HW-U01-F
	HW-U10R-F (early make)	HW-U01R-F (late break)
Dummy Block	HW-DB	

- ① Dummy blocks (no contacts) are used with an odd number of contact blocks.
- ② Combining HW-U10R-F and HW-U01R-F result in overlapping contacts.

Transformers

Style	Primary Voltage (50/60Hz)	Part Number
	120V AC	TW-F126B
	240V AC	TW-F246B
	480V AC	HW-L486

① 6V secondary voltage (uses 6V LED).

Full Voltage Modules

Style	Description	Part Number
Dummy Block with Full Voltage Adaptor	For use with odd number of contacts.	Finger-Safe HW-DA1FBN
Full Voltage Adaptor	For use with even number of contacts.	Finger-Safe TW-DA1FB

① All Transformers step down to 6V (use 6V lamp).

Pilot Lights (Assembled)



Assembled Pilot Lights

A P D 1 126 D NU R

Function _____
P: Pilot Light

Series Designation _____
D: TWND Series

Lens Shape _____
1: Dome

Rated Operational Voltage (Primary) _____

Transformer Type Full Voltage Type
126: 120V AC 66: 6VAC/DC
246: 240V AC 11: 12VAC/DC
486: 480V AC 22: 24VAC/DC
 QH2: 120VAC
 QM4: 240VAC

Lens Color Code

A: Amber
G: Green
R: Red
S: Blue
W: White
Y: Yellow

D: LED

Use only when interpreting part numbers. Do not use for developing part numbers.

LED Pilot Lights

Style	Operating Voltage	Part Number
		LED
 Transformer Dome	120V AC	APD1126DNU ^②
	240V AC	APD1246DNU ^②
	480V AC	APD1486DNU ^②
 Full Voltage Dome	—	APD1 ^③ DNU ^②

② Lens Color Codes

Color	Code
Amber	A
Green	G
Red	R
Blue	S
White	W
Yellow	Y

③ Full Voltage Codes

Voltage	Code
6V AC/DC	66
12V AC/DC	11
24V AC/DC	22
120V AC	QH2
240V AC	QM4

- 1. In place of ②, specify the Lens/LED Color Code.
- 2. In place of ③, specify the Full Voltage Code (LED voltage).
- 3. Yellow pilot light comes with white LED.

Pilot Lights (Sub-Assembled)



* Not required for full voltage units.



Operators

Style	Part Number
Transformer or FULL Voltage	APD09ST8

Full Voltage Clips

Primary Voltage (50/60Hz)	Part Number
	APD-F

Required for all full voltage models. Two pieces each. 2 clips required for full voltage pilot lights

Lenses

Style	Part Number
Dome Lens	APN106LN-②

1. In place of ②, specify the Lens Color Code.

Transformers (only for Pilot Lights)

Style	Primary Voltage (50/60Hz)	Part Number
LED	120V AC	TWD-0126
	240V AC	TWD-0246
	480V AC	TWD-0486

6V secondary voltage (use 6V lamp).

Lamps

Style	Voltage	Part Number
LED	6V AC/DC	LSTD-6③
	12V AC/DC	LSTD-1③
	24V AC/DC	LSTD-2③
	120V AC	LSTD-H2③
	240V AC	LSTD-M4③

1. In place of ③, specify the LED color code.
2. The LED contains a current-limiting resistor and a protection diode.

② **Lens Color Codes**

Color	Code
Amber	A
Green	G
Red	R
Blue	S
White	W
Yellow	Y

③ **LED Color Codes**

Color	Code
Amber	A
Green	G
Red	R
Blue	S
White	W

Yellow LED not available, use white LED with Yellow lens.

Illuminated Pushbuttons (Assembled)



Assembled Illuminated Pushbuttons

A L () D 2 126 11 D NU R

<p>Function</p> <p>L: Momentary Action OL: Maintained Action</p> <p>Bezel Shape</p> <p>Blank: Octagonal F: Full Shroud</p> <p>Series Designation</p> <p>D: TWND Series</p> <p>Lens Shape</p> <p>2: Extended 3: Mushroom ø 40mm</p> <p>Rated Operational Voltage (Primary)</p> <table border="0"> <tr> <td>Transformer Type</td> <td>Full Voltage Type</td> </tr> <tr> <td>126: 120V AC</td> <td>66: 6VAC/DC</td> </tr> <tr> <td>246: 240V AC</td> <td>11: 12VAC/DC</td> </tr> <tr> <td>486: 480V AC</td> <td>22: 24VAC/DC</td> </tr> <tr> <td></td> <td>QH2: 120VAC</td> </tr> <tr> <td></td> <td>QM4: 240VAC</td> </tr> </table>	Transformer Type	Full Voltage Type	126: 120V AC	66: 6VAC/DC	246: 240V AC	11: 12VAC/DC	486: 480V AC	22: 24VAC/DC		QH2: 120VAC		QM4: 240VAC	<p>Lens Color Code</p> <p>A: Amber G: Green R: Red S: Blue W: White Y: Yellow</p> <p>D: LED</p> <p>Contact Arrangement</p> <p>20: 2NO 02: 2NC 11: 1NO-1NC</p>
Transformer Type	Full Voltage Type												
126: 120V AC	66: 6VAC/DC												
246: 240V AC	11: 12VAC/DC												
486: 480V AC	22: 24VAC/DC												
	QH2: 120VAC												
	QM4: 240VAC												

1. Use only when interpreting part numbers. Do not use for developing part numbers.
2. All transformers step down to 6V.

Illuminated Pushbuttons (Assembled)

Illuminated Pushbuttons

Style	Contacts	Part Number		
		Momentary	Maintained	
Extended Lens 	Full Voltage	1NO-1NC 2NO 2NC	ALD2Ⓞ11DNUⓄ ALD2Ⓞ20DNUⓄ ALD2Ⓞ02DNUⓄ	AOLD2Ⓞ11DNUⓄ AOLD2Ⓞ20DNUⓄ AOLD2Ⓞ02DNUⓄ
	Transformer	1NO-1NC 2NO 2NC	ALD2 ⊕ 11DNUⓄ ALD2 ⊕ 20DNUⓄ ALD2 ⊕ 02DNUⓄ	AOLD2 ⊕ 11DNUⓄ AOLD2 ⊕ 20DNUⓄ AOLD2 ⊕ 02DNUⓄ
Extended Lens with Full Shroud 	Full Voltage	1NO-1NC 2NO 2NC	ALFD2Ⓞ11DNUⓄ ALFD2Ⓞ20DNUⓄ ALFD2Ⓞ02DNUⓄ	AOLFD2Ⓞ11DNUⓄ AOLFD2Ⓞ20DNUⓄ AOLFD2Ⓞ02DNUⓄ
	Transformer	1NO-1NC 2NO 2NC	ALFD2 ⊕ 11DNUⓄ ALFD2 ⊕ 20DNUⓄ ALFD2 ⊕ 02DNUⓄ	AOLFD2 ⊕ 11DNUⓄ AOLFD2 ⊕ 20DNUⓄ AOLFD2 ⊕ 02DNUⓄ
ø 40mm Mushroom Lens 	Full Voltage	1NO-1NC 2NO 2NC	ALD3Ⓞ11DNUⓄ ALD3Ⓞ20DNUⓄ ALD3Ⓞ02DNUⓄ	AOLD3Ⓞ11DNUⓄ AOLD3Ⓞ20DNUⓄ AOLD3Ⓞ02DNUⓄ
	Transformer	1NO-1NC 2NO 2NC	ALD3 ⊕ 11DNUⓄ ALD3 ⊕ 20DNUⓄ ALD3 ⊕ 02DNUⓄ	AOLD3 ⊕ 11DNUⓄ AOLD3 ⊕ 20DNUⓄ AOLD3 ⊕ 02DNUⓄ

② Lens Color Codes

Color	Code
Amber	A
Green	G
Red	R
Blue	S
White	W
Yellow	Y

③ Full Voltage Codes

Voltage	Code
6V AC/DC	66
12V AC/DC	11
24V AC/DC	22
120V AC	QH2
240V AC	QM4

④ Transformer Voltage Codes

Voltage	Code
120VAC	126
240VAC	246
480VAC	486

 6V secondary voltage (uses 6V LED).

- 1. In place of Ⓞ, specify the Lens Color Code.
- 2. In place of Ⓞ, specify the Full Voltage Code (LED voltage).
- 3. In place of ⊕, specify the Transformer Voltage Code.
- 4. Light is independent of switch position.
- 5. Yellow pushbutton comes with white LED only.

Illuminated Pushbuttons (Sub-Assembled)



*Not required for full voltage types.

Operators

Style	Image	Part Number	
		Momentary	Maintained
Extended		ALD2300T8	AOLD2300T8
Extended with Full Shroud		ALFD2300T8	AOLFD2300T8
40mm Mushroom		ALD2300T8	AOLD2300T8

Lenses

Style	Image	Part Number
Extended		ALN06LU-Ⓞ
ø 40mm Mushroom		ALN3LU-Ⓞ

In place of Ⓞ, specify the Lens Color Code.

Lamp Circuit Components

Style	Application	Part Number
Long Lamp Holder 	Used with Full-size Transformer and two contact blocks Used with Full Voltage Adaptor and two contact blocks	TW-LH2
Lead Holder 	Used with TW-LH2 holder when using four contact blocks	HW-LH3

Lamps

Style	Voltage	Part Number
	6V AC/DC	LSTD-6Ⓞ
	12V AC/DC	LSTD-1Ⓞ
	24V AC/DC	LSTD-2Ⓞ
	120V AC	LSTD-H2Ⓞ
	240V AC	LSTD-M4Ⓞ

1. In place of Ⓞ, specify the LED color code.
2. The LED contains a current-limiting resistor and a protection diode.

Ⓞ Lens Color Codes

Color	Code
Amber	A
Green	G
Red	R
Blue	S
White	W
Yellow	Y

Ⓞ LED Color Codes

Color	Code
Amber	A
Green	G
Red	R
Blue	S
White	W

Yellow lens only. Yellow LED not available, use white LED.

Contact Blocks

Style	Image	Part Number	
		1NO	1NC
All Control Units		HW-U10-F	HW-U01-F
		HW-U10R-F (early make)	HW-U01R-F (late break)
Dummy Block		HW-DB	

1. Dummy blocks (no contacts) are used with an odd number of contact blocks.
2. Combining HW-U10R-F and HW-U01R-F result in overlapping contacts (remain on, or closed, when switch is moved between two positions).

Transformers

Style	Primary Voltage (50/60Hz)	Part Number
	120V AC	TW-F126B
	240V AC	TW-F246B
	480V AC	HW-L486

6V secondary voltage (use 6V LED).

Full Voltage Modules

Style	Description	Part Number
Dummy Block with Full Voltage Adaptor 	For use with odd number of contacts. Finger-Safe	HW-DA1FBN
Full Voltage Adaptor 	For use with even number of contacts. Finger-Safe	TW-DA1FB

All Transformers step down to 6V (use 6V lamp).

Non-Illuminated Selector Switches (Assembled)



Assembled Selector Switches

A S D 2 () () 11 NU - ()

Function

S: Selector Switch

Series Designation

D: TWND Series

Number of Positions

2: 2-Position
3: 3-Position

Spring Return Action

Blank: Maintained
1: Spring return from Right
2: Spring return from Left
3: 2-Way spring return from Left and Right

Circuit Number

(See Circuit # column of Selector Switch Contact Arrangement Chart on beginning on page 764.)

Contact Arrangement Code

10: 1NO 01: 1NC
20: 2NO 02: 2NC
40: 4NO 04: 4NC
11: 1NO-1NC 22: 2NO-2NC

Operator Style Code

Blank: Knob Operator
L: Lever Operator
K: Key Operator

- 1. Use only when interpreting part numbers. Do not use for developing part numbers.
- 2. Custom key removal codes available. Please contact IDEC for details.

Non-Illuminated Selector Switches (Assembled)

Non-Illuminated 2-Position Selector Switches

Style					Part Number		
Contact	Mounting	Operator Position			Maintained	Spring Return from Right	Spring Return from Left
		L	R				
1NO	1	0	X	Knob	ASD210NU	ASD2110NU	ASD2210NU
	2	0	0	Lever Key	ASD2L10NU	ASD21L10NU	ASD22L10NU
					ASD2K10NU	ASD21K10NU	ASD22K10NU
1NC	1	X	0	Knob	ASD201NU	ASD2101NU	ASD2201NU
	2	0	0	Lever Key	ASD2L01NU	ASD21L01NU	ASD22L01NU
					ASD2K01NU	ASD21K01NU	ASD22K01NU
1NO 1NC	1	0	X	Knob	ASD211NU	ASD2111NU	ASD2211NU
	2	X	0	Lever Key	ASD2L11NU	ASD21L11NU	ASD22L11NU
					ASD2K11NU	ASD21K11NU	ASD22K11NU
2NO	1	0	X	Knob	ASD220NU	ASD2120NU	ASD2220NU
	2	0	X	Lever Key	ASD2L20NU	ASD21L20NU	ASD22L20NU
					ASD2K20NU	ASD21K20NU	ASD22K20NU
2NC	1	X	0	Knob	ASD202NU	ASD2102NU	ASD2202NU
	2	X	0	Lever Key	ASD2L02NU	ASD21L02NU	ASD22L02NU
					ASD2K02NU	ASD21K02NU	ASD22K02NU
2NO 2NC	1	0	X	Knob Lever Key	ASD222NU	ASD2122NU	ASD2222NU
	2	X	0		ASD2L22NU	ASD21L22NU	ASD22L22NU
	3	0	X		ASD2K22NU	ASD21K22NU	ASD22K22NU
	4	X	0				
2NO 2NC	1	0	X	Knob Lever Key	ASD222NU-111	ASD2122NU-111	ASD2222NU-111
	2	0	X		ASD2L22NU-111	ASD21L22NU-111	ASD22L22NU-111
	3	X	0		ASD2K22NU-111	ASD21K22NU-111	ASD22K22NU-111
	4	X	0				



- The truth table indicates the operating position of contact block when the operator is switched to that position.
X = On (closed contacts) 0 = Off (open contacts)
X-X = Overlapping Contacts: Remain on (closed contacts) when switch is moved between these two positions.
- All knob and lever selector switches come in black. Other colors are available by ordering the knob or lever separately.
- Custom contact arrangements available, see page 764.

Non-Illuminated 3-Position Selector Switches

Style						Part Number			
Contact	Mounting	Operator Position				Maintained	Spring Return from Right	Spring Return from Left	Spring Return Two-Way
		L	C	R					
2NO	1	X	0	0	Knob	ASD320NU	ASD3120NU	ASD3220NU	ASD3320NU
	2	0	0	X	Lever Key	ASD3L20NU	ASD31L20NU	ASD32L20NU	ASD33L20NU
						ASD3K20NU	ASD31K20NU	ASD32K20NU	ASD33K20NU
2NC	1	0	X	X	Knob	ASD302NU	ASD3102NU	ASD3202NU	ASD3302NU
	2	X	X	0	Lever Key	ASD3L02NU	ASD31L02NU	ASD32L02NU	ASD33L02NU
						ASD3K02NU	ASD31K02NU	ASD32K02NU	ASD33K02NU
2NO 2NC	1	X	0	0	Knob Lever Key	ASD322NU	ASD3122NU	ASD3222NU	ASD3322NU
	2	0	0	X		ASD3L22NU	ASD31L22NU	ASD32L22NU	ASD33L22NU
	3	0	X	X		ASD3K22NU	ASD31K22NU	ASD32K22NU	ASD33K22NU
	4	X	X	0					
2NO 2NC	1	X	0	X	Knob Lever Key	ASD322NU-309	ASD3122NU-309	ASD3222NU-309	ASD3322NU-309
	2	X	X	0		ASD3L22NU-309	ASD31L22NU-309	ASD32L22NU-309	ASD33L22NU-309
	3	0	X	0		ASD3K22NU-309	ASD31K22NU-309	ASD32K22NU-309	ASD33K22NU-309
	4	0	0	X					
2NO 2NC	1	0	X	0	Knob Lever Key	ASD322NU-310	ASD3122NU-310	ASD3222NU-310	ASD3322NU-310
	2	0	0	X		ASD3L22NU-310	ASD31L22NU-310	ASD32L22NU-310	ASD33L22NU-310
	3	0	X	0		ASD3K22NU-310	ASD31K22NU-310	ASD32K22NU-310	ASD33K22NU-310
	4	0	0	X					
4NO	1	X	0	0	Knob Lever Key	ASD340NU	ASD3140NU	ASD3240NU	ASD3340NU
	2	0	0	X		ASD3L40NU	ASD31L40NU	ASD32L40NU	ASD33L40NU
	3	X	0	0		ASD3K40NU	ASD31K40NU	ASD32K40NU	ASD33K40NU
	4	0	0	X					
4NC	1	0	X	X	Knob Lever Key	ASD304NU	ASD3104NU	ASD3204NU	ASD3304NU
	2	X	X	0		ASD3L04NU	ASD31L04NU	ASD32L04NU	ASD33L04NU
	3	0	X	X		ASD3K04NU	ASD31K04NU	ASD32K04NU	ASD33K04NU
	4	X	X	0					

Non-Illuminated Selector Switches (Sub-Assembled)

Contact Blocks + Operator + Knob or Lever* + Color Insert* = Complete Part†



- 1. *Not needed with key type switches.
- 2. †Knob type shown.

Operators

Style	Position	Description	Part Number	
 Knob/Lever	2	Maintained	ASD0201T8	
		Spring return from right	ASD0213T8	
		Spring return from left	ASD0224T8	
	3	Maintained, Cam 1 Maintained, Cam 2		ASD0302T8 ASD0306T8
			Spring return from right, Cam 1 Spring return from right, Cam 2	ASD0314T8 ASD0310T8
		Spring return from left, Cam 1 Spring return from left, Cam 2		ASD0323T8 ASD0328T8
Spring return from left/right, Cam 1 Spring return from left/right, Cam 2			ASD0335T8 ASD0339T8	
 Key		2	Maintained	ASD0201KT8
			Spring return from right	ASD0213KT8
	Spring return from left		ASD0224KT8	
	3	Maintained, Cam 1 Maintained, Cam 2		ASD0302KT8 ASD0306KT8
			Spring return from right, Cam 1 Spring return from right, Cam 2	ASD0302KT8B ASD0310KT8B
		Spring return from left, Cam 1 Spring return from left, Cam 2		ASD0323KT8 ASD0310KT8B
Spring return from left/right, Cam 1 Spring return from left/right, Cam 2			ASD0335KT8 ASD3K339KT8	



- 1. Order knobs, levers, color inserts separately (see below).
- 2. For key switches, keys are removable in all maintained positions. Other options available, contact IDEC for details.
- 3. See page 766 "Operator Truth Tables" for details of difference between cams.

① Color Codes

Knob/Lever Color	Code
Black	B
Blue	S
Green	G
Red	R
Yellow	Y
White	W

- 1. Knob/Lever not available in white.
- 2. Color inserts not available in Black.
- 3. Lever not available in yellow.

Handles and Inserts

Style	Part Number
 Knob	ASDHHY-①
 Lever	ASDHHL-①*
 Color Insert	TW-HC1-①

- 1. In place of ①, specify the Color Code.
*Not available in yellow.

Contact Blocks

Style	Part Number	
	1NO	1NC
 All Control Units	HW-U10-F HW-U10R-F (early make)	HW-U01-F HW-U01R-F (late break)
 Dummy Block	HW-DB	

- 1. Dummy blocks (no contacts) are used with an odd number of contact blocks.
- 2. Combining HW-U10R-F and HW-U01R-F result in overlapping contacts (remain on, or closed, when switch is moved between two positions).

Illuminated Selector Switches (Assembled)



Assembled Illuminated Selector Switches

A SL D 2 (2) 22 11 DN U - 111 - R

Function

SL: Illuminated Selector Switch

Series Designation

D: TWND series

Number of Positions

2: 2-Position
3: 3-Position

Spring Return Action

Blank: Maintained
1: Spring return from Right
2: Spring return from Left
3: Two-Way spring return from Left and Right

Rated Operational Voltage (Primary)

Transformer Type	Full Voltage Type
136: 120V AC	66: 6VAC/DC
256: 240V AC	11: 12VAC/DC
486: 480V AC	22: 24VAC/DC
	QH2: 120VAC
	QM4: 240VAC

Contact Arrangement Code

20: 2NO 02: 2NC
40: 4NO 04: 4NC
11: 1NO-1NC 22: 2NO-2NC

Lens Color Code

A: Amber
G: Green
R: Red
S: Blue
W: White
Y: Yellow

Circuit Code Number

See Circuit # column of Selector Switch Contact Arrangement Charts on page 764.

D: LED Lamp

 Use only when interpreting part numbers. Do not use for developing part numbers.

Illuminated Selector Switches (Assembled)

Illuminated 2-Position Selector Switches

Style					Part Number		
Contact	Mounting	Operator Position		Lamp Circuit Type	Maintained	Spring Return from Right	Spring Return from Left
		L	R				
1NO	1	0	X	Transformer Full Voltage	ASLD2 ④11DNU② ASLD2③11DNU②	ASLD21 ④11DNU② ASLD21③11DNU②	ASLD22 ④11DNU② ASLD22③11DNU②
1NC	2	X	0				
2NO	1	0	X	Transformer Full Voltage	ASLD2 ④20DNU② ASLD2③20DNU②	ASLD21 ④20DNU② ASLD21③20DNU②	ASLD22 ④20DNU② ASLD22③20DNU②
2NC	2	0	X				
2NO	1	X	0	Transformer Full Voltage	ASLD2 ④02DNU-② ASLD2③02DNU-104-②	ASLD21 ④02DNU-② ASLD21③02DNU-②	ASLD22 ④02③DNU-② ASLD22③02DNU-②
2NC	2	X	0				
2NO	1	0	X	Transformer Full Voltage	ASLD2 ④22DNU② ASLD2③22DNU②	ASLD21 ④22DNU② ASLD21③22DNU②	ASLD22 ④22DNU② ASLD22③22DNU②
2NC	2	X	0				
2NC	3	0	X				
2NC	4	X	0				
2NO	1	0	X	Transformer Full Voltage	ASLD2 ④22DNU-111-② ASLD2③22DNU-111-②	ASLD21 ④22DNU-111-② ASLD21③22DNU-111-②	ASLD22 ④22DNU-111-② ASLD22③22DNU-111-②
2NC	2	0	X				
2NC	3	X	0				
2NC	4	X	0				

② Lens Color Codes

Color	Code
Amber	A
Green	G
Red	R
Blue	S
White	W
Yellow	Y

③ Full Voltage Codes

Voltage	Code
6V AC/DC	66
12V AC/DC	11
24V AC/DC	22
120V AC	QH2
240V AC	QM4

Illuminated 3-Position Selector Switches, Maintained and Spring Return

Style					Part Number				
Contact	Mounting	Operator Position			Lamp Circuit Type	Maintained	Spring Return From Right	Spring Return from Left	Spring Return Two-Way
		L	C	R					
2NO	1	X	0	0	Transformer Full Voltage	ASLD3 ④ 20DNU② ASLD3③20DNU②	ASLD31 ④ 20DNU② ASLD31③20DNU②	ASLD32 ④ 20DNU② ASLD32③20DNU②	ASLD33 ④ 20DNU② ASLD33③20DNU②
2NC	2	0	0	X					
2NC	1	0	X	X	Transformer Full Voltage	ASLD3 ④ 02DNU② ASLD3③02DNU②	ASLD31 ④ 02DNU② ASLD31③02DNU②	ASLD32 ④ 02DNU② ASLD32③02DNU②	ASLD33 ④ 02DNU② ASLD33③02DNU②
2NC	2	X	X	0					
2NO	1	X	0	0	Transformer Full Voltage	ASLD3 ④ 22DNU② ASLD3③22DNU②	ASLD31 ④ 22DNU② ASLD31③22DNU②	ASLD32 ④ 22DNU② ASLD32③22DNU②	ASLD33 ④ 22DNU② ASLD33③22DNU②
2NC	2	0	0	X					
2NC	3	0	X	X					
2NC	4	X	X	0					
2NO	1	X	0	X	Transformer Full Voltage	ASLD3 ④ 22DNU-309-② ASLD3③22DNU-309-②	ASLD31 ④ 22DNU-309-② ASLD31③22DNU-309-②	ASLD32 ④ 22DNU-309-② ASLD32③22DNU-309-②	ASLD33 ④ 22DNU-309-② ASLD33③22DNU-309-②
2NC	2	X	X	0					
2NC	3	0	X	0					
2NC	4	0	0	X					
2NO	1	0	X	0	Transformer Full Voltage	ASLD3 ④ 22DNU-310-② ASLD3③22DNU-310-②	ASLD31 ④ 22DNU-310-② ASLD31③22DNU-310-②	ASLD32 ④ 22DNU-310-② ASLD32③22DNU-310-②	ASLD33 ④ 22DNU-310-② ASLD33③22DNU-310-②
2NC	2	0	0	X					
2NC	3	0	X	0					
2NC	4	0	0	X					
4NO	1	X	0	0	Transformer Full Voltage	ASLD3 ④ 40DNU② ASLD3③40DNU②	ASLD31 ④ 40DNU② ASLD31③40DNU②	ASLD32 ④ 40DNU② ASLD32③40DNU②	ASLD33 ④ 40DNU② ASLD33③40DNU②
4NO	2	0	0	X					
4NO	3	X	0	0					
4NO	4	0	0	X					
4NC	1	0	X	X	Transformer Full Voltage	ASLD3 ④ 04DNU② ASLD3③04DNU②	ASLD31 ④ 04DNU② ASLD31③04DNU②	ASLD32 ④ 04DNU② ASLD32③04DNU②	ASLD33 ④ 04DNU② ASLD33③04DNU②
4NC	2	X	X	0					
4NC	3	0	X	X					
4NC	4	X	X	0					

- In place of ②, specify the Lens/LED Color Code, in place of ③, specify the Full Voltage (LED voltage) Code, in place of ④, specify the Transformer Voltage Code.
- The truth table indicates the operating position of contact block when the operator is switched to that position.
 X = On (Closed Contacts) 0 = Off (Open Contacts)
 X-X = Overlapping Contacts: Remain on (closed contacts) when switch is moved between these positions
- Yellow selector switch comes with white LED.

④ Transformer Voltage Codes

Voltage	Code
120VAC	136
240VAC	256
480VAC	486

Transformers step down to 6V (use 6V LED).

Illuminated Selector Switches (Sub-Assembled)



*Not required for full voltage units.

Operators

Style	Position	Description	Part Number
Operator 	2	Maintained	ASLD0201T8
	3	Maintained, Cam 1	ASLD0302T8
		Maintained, Cam 2	ASLD0306T8
	2	Spring return from right	ASLD0213T8
		Spring return from left	ASLD0224T8
	3	Spring return from right, Cam 1	ASLD0314T8
		Spring return from right, Cam 2	ASLD0310T8
		Spring return from left, Cam 1	ASLD0323T8
		Spring return from left, Cam 2	ASLD0328T8
		Spring return from left/right, Cam 1	ASLD0335T8
Spring return from left/right, Cam 2		ASLD0339T8	

Lenses



Style	Part Number
Knob 	ASLNHU-③ ②

Lamps

Style	Voltage	Part Number
LED 	6V AC/DC	LSTD-6③
	12V AC/DC	LSTD-1③
	24V AC/DC	LSTD-2③
	120V AC	LSTD-H2③
	240V AC	LSTD-M4③

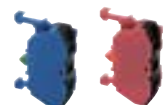

- In place of ②, specify the LED color code.
- The LED contains a current-limiting resistor and a protection diode.

Contact Blocks



Style	Part Number	
	1NO	1NC
All Control Units 	HW-U10-F	HW-U10-F
	HW-U10R-F (early make)	HW-U10R-F (late break)
Dummy Block 	HW-DB	

- Dummy blocks (no contacts) are used with an odd number of contact blocks.
- Combining HW-U10R-F and HW-U01R-F result in overlapping contacts (remain on, or closed, when switch is moved between two positions).

Lamp Circuit Components

Style	Application	Part Number
Long Lamp Holder 	Used with Full-size Transformer and two contact blocks	TW-LH2
Lead Holder 	Used with Full Voltage Adaptor and two contact blocks	
	Used with TW-LH2 holder when using four contact blocks	HW-LH3

Full Voltage Modules

Style	Description	Part Number
Dummy Block with Full Voltage Adaptor 	For use with odd number of contacts. Finger-Safe	HW-DA1FBN
Full Voltage Adaptor 	For use with even number of contacts. Finger-Safe	TW-DA1FB

- All Transformers step down to 6V (use 6V lamp).

Transformers

Style	Primary Voltage (50/60Hz)	Part Number
Transformers 	120V AC	TW-F126B
	240V AC	TW-F126B
	480V AC	HW-L486

- 6V secondary voltage.

② Lens Color Codes

Color	Code
Amber	A
Green	G
Red	R
Blue	S
White	W
Yellow	Y

③ LED Color Codes

Color	Code
Amber	A
Green	G
Red	R
Blue	S
White	W

- Yellow lens only. Yellow LED not available, use white LED.

Contact Arrangement Charts

How to Read Contact Arrangement Charts

To determine contact block mounting position, first make sure the selector switch is oriented as shown on the right

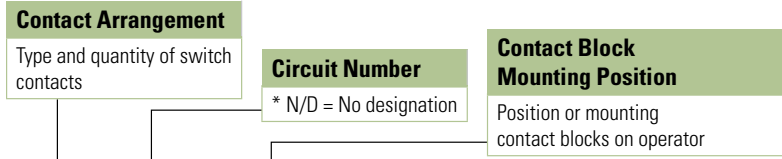
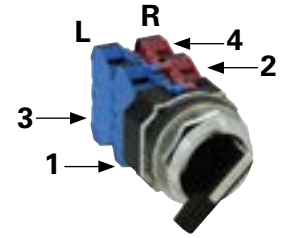

Operator Position

Truth table indicates the operating position of contact block when operator is switched to that position.

X = On (Closed Contacts)
 O = Off (Open Contacts)
 X-X = Overlapping Contacts: Remain on (closed) when switch is moved between these two positions

Contact Block Part Number

Part number to use when ordering sub-assembly contact blocks, as required for use with corresponding mounting position

Contact Arrangement Chart: 2-Position Selector Switches

Style		Mounting Position	Operator Position		Contact Block Part Number	Description	Operator Part Number		
Contact	Circuit Number		L	R			Maintained	Spring Return from Right	Spring Return from Left
							L	R	L
1NO	N/D	1	O	X	HW-U10-F	Knob/Lever Key	ASD0201T8 ASD0201KT8 ASLD0201T8	ASD0213T8 ASD0213KT8 ASLD0213T8	ASD0224T8 ASD0224KT8 ASLD0224T8
		2	O	O	HW-DB	Illuminated Knob			
1NC	N/D	1	X	O	HW-U01-F	Knob/Lever Key	ASD0201T8 ASD0201KT8 ASLD0201T8	ASD0213T8 ASD0213KT8 ASLD0213T8	ASD0224T8 ASD0224KT8 ASLD0224T8
		2	O	O	HW-DB	Illuminated Knob			
1NO 1NC	N/D	1	O	X	HW-U10-F	Knob/Lever Key	ASD0201T8 ASD0201KT8 ASLD0201T8	ASD0213T8 ASD0213KT8 ASLD0213T8	ASD0224T8 ASD0224KT8 ASLD0224T8
		2	X	O	HW-U01-F	Illuminated Knob			
	103	1	X	O	HW-U01-F	Knob/Lever Key	ASD0201T8 ASD0201KT8 ASLD0201T8	ASD0213T8 ASD0213KT8 ASLD0213T8	ASD0224T8 ASD0224KT8 ASLD0224T8
		2	O	X	HW-U10-F	Illuminated Knob			
1NO-EM 1NC-LB	600	1	O	X	HW-U10R-F	Knob/Lever Key	ASD0201T8 ASD0201KT8 ASLD0201T8	ASD0213T8 ASD0213KT8 ASLD0213T8	ASD0224T8 ASD0224KT8 ASLD0224T8
		2	X	O	HW-U01R-F	Illuminated Knob			
	601	1	X	O	HW-U01R-F	Knob/Lever Key	ASD0201T8 ASD0201KT8 ASLD0201T8	ASD0213T8 ASD0213KT8 ASLD0213T8	ASD0224T8 ASD0224KT8 ASLD0224T8
		2	O	X	HW-U10R-F	Illuminated Knob			
2NO	N/D	1	O	X	HW-U10-F	Knob/Lever Key	ASD0201T8 ASD0201KT8 ASLD0201T8	ASD0213T8 ASD0213KT8 ASLD0213T8	ASD0224T8 ASD0224KT8 ASLD0224T8
		2	O	X	HW-U10-F	Illuminated Knob			
2NC	N/D	1	X	O	HW-U01-F	Knob/Lever Key	ASD0201T8 ASD0201KT8 ASLD0201T8	ASD0213T8 ASD0213KT8 ASLD0213T8	ASD0224T8 ASD0224KT8 ASLD0224T8
		2	X	O	HW-U01-F	Illuminated Knob			
2NO 2NC	N/D	1	O	X	HW-U10-F	Knob/Lever Key	ASD0201T8 ASD0201KT8 ASLD0201T8	ASD0213T8 ASD0213KT8 ASLD0213T8	ASD0224T8 ASD0224KT8 ASLD0224T8
		2	X	O	HW-U01-F	Illuminated Knob			
		3	O	X	HW-U10-F	Illuminated Knob			
		4	X	O	HW-U01-F	Illuminated Knob			
	110	1	X	O	HW-U01-F	Knob/Lever Key	ASD0201T8 ASD0201KT8 ASLD0201T8	ASD0213T8 ASD0213KT8 ASLD0213T8	ASD0224T8 ASD0224KT8 ASLD0224T8
		2	O	X	HW-U10-F	Illuminated Knob			
		3	X	O	HW-U01-F	Illuminated Knob			
		4	O	X	HW-U10-F	Illuminated Knob			
111	1	O	X	HW-U10-F	Knob/Lever Key	ASD0201T8 ASD0201KT8 ASLD0201T8	ASD0213T8 ASD0213KT8 ASLD0213T8	ASD0224T8 ASD0224KT8 ASLD0224T8	
	2	O	X	HW-U10-F	Illuminated Knob				
	3	X	O	HW-U01-F	Illuminated Knob				
	4	X	O	HW-U01-F	Illuminated Knob				
4NO	N/D	1	O	X	HW-U10-F	Knob/Lever Key	ASD0201T8 ASD0201KT8 ASLD0201T8	ASD0213T8 ASD0213KT8 ASLD0213T8	ASD0224T8 ASD0224KT8 ASLD0224T8
		2	O	X	HW-U10-F	Illuminated Knob			
		3	O	X	HW-U10-F	Illuminated Knob			
		4	O	X	HW-U10-F	Illuminated Knob			

Contact Arrangement Chart: 3-Position Selector Switches

Style		Mounting Position	Operator Position			Contact Block Part Number	Description	Operator Part Number				
Contact	Circuit Number		L	C	R			Maintained	Spring Return from Right	Spring Return from Left	Two-Way	
1NO 1NC	202	1	X	0	0	HW-U10-F	Knob/Lever Key	ASD0302T8 ASD0302KT8	ASD0314T8 ASD0314KT8	ASD0323T8 ASD0323KT8	ASD0335T8 ASD0335KT8	
		2	X—X	0	0	HW-U01-F	Illuminated Knob	ASLD0302T8	ASLD0314T8	ASLD0323T8	ASLD0335T8	
	203	1	0	X—X	0	HW-U01-F	Knob/Lever Key	ASD0302T8 ASD0302KT8	ASD0314T8 ASD0314KT8	ASD0323T8 ASD0323KT8	ASD0335T8 ASD0335KT8	
		2	0	0	X	HW-U10-F	Illuminated Knob	ASLD0302T8	ASLD0314T8	ASLD0323T8	ASLD0335T8	
	302	1	X	0	X	HW-U10-F	Knob/Lever Key	ASD0306T8 ASD0306KT8	ASD0310T8 ASD0301KT8	ASD0328T8 ASD0328KT8	ASD0339T8 ASD0339KT8	
		2	X—X	0	0	HW-U01-F	Illuminated Knob	ASLD0306T8	ASLD310T8	ASLD0328T8	ASLD0339T8	
	303	1	0	X	0	HW-U01-F	Knob/Lever Key	ASD0306T8 ASD0306KT8	ASD0310T8 ASD0301KT8	ASD0328T8 ASD0328KT8	ASD0339T8 ASD0339KT8	
		2	0	0	X	HW-U10-F	Illuminated Knob	ASLD0306T8	ASLD310T8	ASLD0323T8	ASLD0339T8	
	2NO	N/D	1	X	0	0	HW-U10-F	Knob/Lever Key	ASD0302T8 ASD0302KT8	ASD0314T8 ASD0314KT8	ASD0323T8 ASD0323KT8	ASD0335T8 ASD0335KT8
			2	0	0	X	HW-U10-F	Illuminated Knob	ASLD0302T8	ASLD0314T8	ASLD0323T8	ASLD0335T8
301		1	X	0	X	HW-U10-F	Knob/Lever Key	ASD0306T8 ASD0306KT8	ASD0310T8 ASD0301KT8	ASD0328T8 ASD0328KT8	ASD0339T8 ASD0339KT8	
		2	0	0	X	HW-U10-F	Illuminated Knob	ASLD0306T8	ASLD310T8	ASLD0328T8	ASLD0339T8	
2NC	304	1	0	X	0	HW-U01-F	Knob/Lever Key	ASD0306T8 ASD0306KT8	ASD0310T8 ASD0301KT8	ASD0328T8 ASD0328KT8	ASD0339T8 ASD0339KT8	
		2	X—X	0	0	HW-U01-F	Illuminated Knob	ASLD0306T8	ASLD310T8	ASLD0328T8	ASLD0339T8	
	N/D	1	0	X—X	0	HW-U01-F	Knob/Lever Key	ASD0302T8 ASD0302KT8	ASD0314T8 ASD0314KT8	ASD0323T8 ASD0323KT8	ASD0335T8 ASD0335KT8	
		2	X—X	0	0	HW-U01-F	Illuminated Knob	ASLD0302T8	ASLD0314T8	ASLD0323T8	ASLD0335T8	
2NO 2NC	N/D	1	X	0	0	HW-U10-F	Knob/Lever Key Illuminated Knob	ASD0302T8	ASD0314T8	ASD0323T8	ASD0335T8	
		2	0	0	X	HW-U10-F		ASD0302KT8	ASD0314KT8	ASD0323KT8	ASD0335KT8	
		3	0	X—X	0	HW-U01-F		ASLD0302T8	ASLD0314T8	ASLD0323T8	ASLD0335T8	
		4	X—X	0	0	HW-U01-F		ASLD0302T8	ASLD0314T8	ASLD0323T8	ASLD0335T8	
	210	1	0	X—X	0	HW-U01-F	Knob/Lever Key Illuminated Knob	ASD0302T8	ASD0314T8	ASD0323T8	ASD0335T8	
		2	0	0	X	HW-U10-F		ASD0302KT8	ASD0314KT8	ASD0323KT8	ASD0335KT8	
		3	0	X—X	0	HW-U01-F		ASLD0302T8	ASLD0314T8	ASLD0323T8	ASLD0335T8	
		4	0	0	X	HW-U10-F		ASLD0302T8	ASLD0314T8	ASLD0323T8	ASLD0335T8	
	308	1	X	0	X	HW-U10-F	Knob/Lever Key Illuminated Knob	ASD0306T8	ASD0310T8	ASD0328T8	ASD0339T8	
		2	X—X	0	0	HW-U01-F		ASD0306KT8	ASD0301KT8	ASD0328KT8	ASD0339KT8	
		3	X	0	X	HW-U10-F		ASLD0306T8	ASLD310T8	ASLD0328T8	ASLD0339T8	
		4	X—X	0	0	HW-U01-F		ASLD0306T8	ASLD310T8	ASLD0328T8	ASLD0339T8	
	309	1	X	0	X	HW-U10-F	Knob/Lever Key Illuminated Knob	ASD0306T8	ASD0310T8	ASD0328T8	ASD0339T8	
		2	X—X	0	0	HW-U01-F		ASD0306KT8	ASD0301KT8	ASD0328KT8	ASD0339KT8	
		3	0	X	0	HW-U01-F		ASLD0306T8	ASLD310T8	ASLD0328T8	ASLD0339T8	
		4	0	0	X	HW-U10-F		ASLD0306T8	ASLD310T8	ASLD0328T8	ASLD0339T8	
310	1	0	X	0	HW-U01-F	Knob/Lever Key Illuminated Knob	ASD0306T8	ASD0310T8	ASD0328T8	ASD0339T8		
	2	0	0	X	HW-U10-F		ASD0306KT8	ASD0301KT8	ASD0328KT8	ASD0339KT8		
	3	0	X	0	HW-U01-F		ASLD0306T8	ASLD310T8	ASLD0328T8	ASLD0339T8		
	4	0	0	X	HW-U10-F		ASLD0306T8	ASLD310T8	ASLD0328T8	ASLD0339T8		

- Each operator sub-assembly is available as an "02" and an "06" for 3-position selector switches. The internal cam of an "02" is different from that of an "06". This results in designated combinations of open and closed contacts in the various operator positions.
- N/D = No circuit number designation required in assembled part number.
- X = On (closed contacts) 0 = Off (open contacts). X—X Overlapping contacts remain on (closed) when switch is moved between these two positions.

Contact Arrangement Chart: 3-Position Selector Switches

Style		Mounting Position	Operator Position			Contact Block Part Number	Description	Operator Part Number			
Contact	Circuit Number		L	C	R			Maintained	Spring Return from Right	Spring Return from Left	Two-Way
4NO	N/D	1	X	0	0	HW-U10-F					
		2	0	0	X	HW-U10-F	Knob/Lever Key	ASD0302T8 ASD0302KT8 ASLD0302T8	ASD0314T8 ASD0314KT8 ASLD0314T8	ASD0323T8 ASD0323KT8 ASLD0323T8	ASD0335T8 ASD0335KT8 ASD0335T8
		3	X	0	0	HW-U10-F	Illuminated Knob				
		4	0	0	X	HW-U10-F					
	305	1	X	0	X	HW-U10-F					
		2	0	0	X	HW-U10-F	Knob/Lever Key	ASD0306T8 ASD0306KT8 ASLD0306T8	ASD0310T8 ASD0301KT8 ASLD0310T8	ASD0328T8 ASD0328KT8 ASLD0328T8	ASD0339T8 ASD0339KT8 ASLD0339T8
		3	X	0	X	HW-U10-F	Illuminated Knob				
		4	0	0	X	HW-U10-F					
4NC	N/D	1	0	X	X	HW-U01-F					
		2	X	X	0	HW-U01-F	Knob/Lever Key	ASD0302T8 ASD0302KT8 ASLD0302T8	ASD0314T8 ASD0314KT8 ASLD0314T8	ASD0323T8 ASD0323KT8 ASLD0323T8	ASD0335T8 ASD0335KT8 ASD0335T8
		3	0	X	X	HW-U01-F	Illuminated Knob				
		4	X	X	0	HW-U01-F					
	314	1	0	X	0	HW-U01-F					
		2	X	X	0	HW-U01-F	Knob/Lever Key	ASD0306T8 ASD0306KT8 ASLD0306T8	ASD0310T8 ASD0301KT8 ASLD0301T8	ASD0328T8 ASD0328KT8 ASLD0328T8	ASLD0339T8 ASD0339KT8 ASLD0339T8
		3	0	X	0	HW-U01-F	Illuminated Knob				
		4	X	X	0	HW-U01-F					

- Each operator sub-assembly is available as an "02" and an "06" for 3-position selector switches. The internal cam of an "02" is different from that of an "06". This results in designated combinations of open and closed contacts in the various operator positions.
- N/D = No circuit number designation required in assembled part number.
- X = On (closed contacts) 0 = Off (open contacts). X-X Overlapping contacts remain on (closed) when switch is moved between these two positions.

Operator Truth Tables

Use the following tables to build custom selector switches.

2 Position Selector Switches

	Contact	Mounting Position	Operator Position	
			Left	Right
ASLD0201T8	HW-U10-F (NO)	L	0	X
		R	0	X
	HW-U01-F (NC)	L	X	0
		R	X	0
	HW-U10R-F (NO-EM)	L	0	X-X
		R	0	X-X
	HW-U01R-F (NC-LB)	L	X-X	0
		R	X-X	0

3 Position Selector Switches

	Contact	Mounting Position	Operator Position		
			Left	Center	Right
ASD0302T8 ASLD0302T8 ASD0302KT8	HW-U10-F (NO)	L	X	0	0
		R	0	0	X
	HW-U01-F (NC)	L	0	X-X	0
		R	X-X	0	0
	HW-U10R-F (NO-EM)	L	X	0	0
		R	0	0	X
	HW-U10R-F (NC-LB)	L	0	X-X	0
		R	X-X	0	0

	Contact	Mounting Position	Operator Position		
			Left	Center	Right
ASD0306T8 ASLD0306T8 ASD0306KT8	HW-U10-F (NO)	L	X	0	X
		R	0	0	X
	HW-U01-F (NC)	L	0	X	0
		R	X-X	0	0
	HW-U10R-F (NO-EM)	L	X	0	X
		R	0	0	X
	HW-U01R-F (NC-LB)	L	0	X	0
		R	X-X	0	0

Accessories — TWND Series

Item	Appearance	Description/Usage	Part Number
Lamp Removal Tool		Rubber tool used to install or remove LED's	OR-55
Metal Bezel		Standard octagonal units (chrome-pl.).	OG-81
		Extended, non-illuminated (chrome-pl.).	OG-82
		Extended, illuminated (chrome-pl.).	OG-83L
		Jumbo Mushroom Shallow Shroud	ABN4G
		Jumbo Mushroom Deep Shroud	ABN4F
Plastic Bezel		Black plastic locking ring/bezel	OGP11B
Boot/Cover		In place of ⊕, specify Neoprene Rubber Boot color: B (black), G (green), R (red), Y (yellow)	OC-11 ⊕
		Flush units (clear plastic -40° to +60°C).	OC-121
		Extended units (clear plastic -40° to +60°C).	OC-122
Anti-Rotation Ring		Plastic washer For nameplates or panels that should not be scratched.	OGL-D1T
		Thrust washer/Anti-rotation ring for use with notched panel cutout.	OGL-D1S
Mounting Hole Plug		Plastic with locking nut attached.	OBP-11
		Metal with locking nut attached	OB-11
		Grey rubber (-5° to +60°C)	OB-13
Terminal Tab Adaptor		Tab #250 17/64" x 3/64" (6.35mm x 0.8mm); Single tab	TW-FA4
Long Lamp Holder		Used with Transformer and two contact blocks Used with Full Voltage Adaptor and two contact blocks	TW-LH2
Lead Holder		Used with TW-LH2 holder when using four contact blocks	HW-LH3
Lock Out Adaptor		Used to provide lockout protection for TWTD pushbuttons and knob selectors. ø 1-13/64" (30mm)	OL-KL1
Full Voltage Clips		Primary Voltage (50/60Hz) Required for all full voltage pilot lights. Two pieces each. 2 clips required for full voltage pilot lights.	APD-F
Replacement Keys		Pair of keys (#0)	TW-SK

Switches & Pilot Devices

Signaling Lights

Relays & Sockets

Timers

Contactors



Terminal Blocks

Circuit Breakers

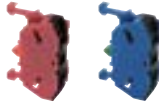
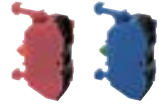
Accessories TWND Series continued

Item	Appearance	Description/Usage	Part Number	
			1NC	1NO
Contact Blocks (with side entry)		These contacts are applicable for wires terminated by ring, fork, terminals, not recommended for bare wire connections.	HW-U01 HW-U01-MAU HW-U01R HW-U01R-MAU (with side entry)	HW-U10 HW-U10-MAU HW-U10R HW-U10R-MAU (with side entry)
Contact Blocks (without side entry)		These contacts are applicable for wires terminated by ring, fork, or ferule terminals, and also bare wire connections.	HW-U01-F HW-U01-MAU-F HW-U01R-F HW-U01R-MAU-F (no side entry)	HW-U10-F HW-U10-MAU-F HW-U10R-F HW-U10R-MAU-F (no side entry)

Fingersafe Covers for TWND Series

Item	Description	Used with	Part Number
	Fingersafe terminal cover, for full voltage pilot lights, adds 3mm to overall depth	Full voltage pilot lights	APD-PVL
	Fingersafe terminal cover, adds 1.5mm to overall depth	Transformer pilot lights	N-VL3

Nameplates – TWND Series

Faceplates

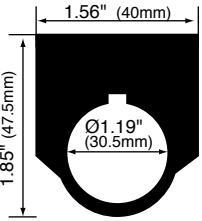
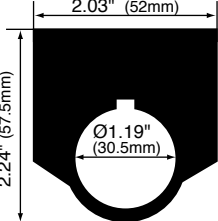
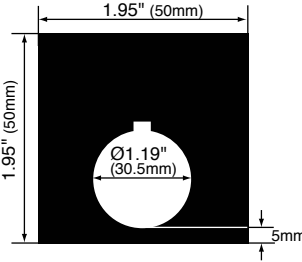
	NALD	NAKD	NAQD
Dimensions			
Description	Part Number		
Nameplate (blank)	NALD-B (black) NALD-R (red)	NAKD-B (black) NAKD-R (red)	NAQD-B (black) NAQD-R (red)
Nameplate (engraved)	NALD-⓪	NAKD-⓪	NAQD-⓪

1. Nameplates are made of 0.031" aluminum. Lettering is white letters engraved on black background.
2. In place of ⓪, insert either the standard legend code from table below or custom engraving delimited by " ".

Standard Legend Codes

Pushbuttons				Pushbuttons/Selector Switches				Selector Switches	
Legend	Code	Legend	Code	Legend	Code	Legend	Code	Legend	Code
AUTO	101	OPEN	116	AUTO-MAN	201			AUTO-MAN-OFF	301
CLOSE	102	OUT	117	CLOSE-OPEN	202			AUTO-OFF-MAN	302
DOWN	103	RAISE	118	DOWN-UP	203			CLOSE-OFF-OPEN	303
EMERG.STOP*	104	RESET	119	FAST-SLOW	204			DOWN-OFF-SLOW	304
FAST	105	REVERSE	120	FOR-REV	205	REV-FOR	216	FAST-OFF-SLOW	305
FORWARD	106	RUN	121	HAND-AUTO	206	RUN-JOG	217	FOR-OFF-REV	306
HAND	107	SLOW	122	HIGH-LOW	207	RUN-SAFE	218	LEFT-OFF-RIGHT	307
HIGH	108	START	123	JOG-RUN	208	SAFE-RUN	219	LOWER-OFF-RAISE	308
IN	109	STOP*	124	LEFT-RIGHT	209	SLOW-FAST	220	OFF-MAN-AUTO	309
INCH	110	STOP	125	LOWER-RAISE	210	START-STOP	221	OFF-SLOW-FAST	310
JOG	111	TEST	126	MAN-AUTO	211	STOP-START	222	OFF-1-2	311
LOW	112	UP	127	OFF-ON	212	UP-DOWN	223	OPEN-OFF-CLOSE	312
LOWER	113	I (Int'l On)	150	ON-OFF	213			SLOW-OFF-FAST	313
OFF	114	O (Int'l Off)	151	OPEN-CLOSE	214			SUMMER-OFF-WINTER	314
ON	115	EMO	152	RAISE-LOWER	215			UP-OFF-DOWN	315
								1-OFF-2	316
								HAND-OFF-AUTO	317

1. *Available in Red as standard legend code 104 and 124. To order engraved nameplate and codes, add legend code to nameplate part number. Character height based on the number of characters, space and size of nameplate. Standard character size is 3/16".
2. Nameplates with standard legends are the same list price as blank nameplates. Special engravings, additional cost.

To specify engraving instructions, use the Nameplate order form on next page.

Custom engraved Nameplates Order Form – TWND Series

Copy this order form and use it to specify Letter Height, Custom Engravings, Location of Engraving on Nameplate, and Quantity Desired.

To ensure engraving accuracy, fax it to your IDEC representative. or Distributor.

Your Company Name: _____

IDEC Rep/Distributor Contact: _____

Your Name: _____

PO number (if known): _____

Telephone: _____

IDEC Rep/Distributor Phone: _____

Fax & Email: _____

IDEC Rep/Distributor Fax & Email: _____

NALD Nameplate

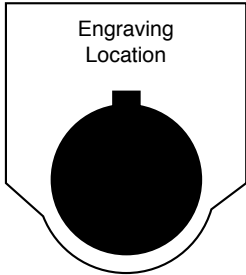

Step 1.

Choose Letter Size - 7/64" or 1/8".

Check the box for the letter size you want. Then write your lettering in box below checkboxes. Note: 1/8" size letters cannot exceed 13 characters.

Sample Letter Sizes

7/64"
Letter Size 16 characters max
(for 7/64" size letters)

7/64" Letters: **A B C D**

1/8" Letters: **A B C D**

1/8"
Letter Size 13 characters max
(for 1/8" size letters)

Step 2.

Specify Quantity.

Enter the number of nameplates desired in the box on the right.

Qty

1	2	3	4	5	6	7	8	9	10	11	12	13	14	15	16
---	---	---	---	---	---	---	---	---	----	----	----	----	----	----	----

NAKD Nameplate

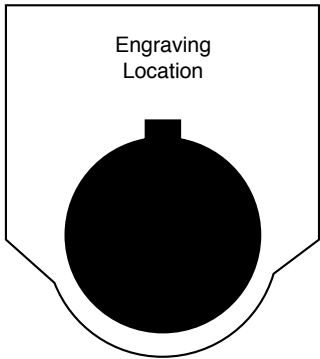

Step 1.

Choose Letter Size - 7/64" or 1/8".

Check the box for the letter size you want. Then write your lettering in box below checkboxes. Note: 1/8" size letters cannot exceed 9 characters.

Step 2.

Specify Quantity.

Enter the number of nameplates desired in the box on the right.

Qty

1	2	3	4	5	6	7	8	9	10	11	12	13	14	15	16	17
---	---	---	---	---	---	---	---	---	----	----	----	----	----	----	----	----

Sample Letter Sizes

1/8" Letters: **A B C D**

NAQD Nameplate

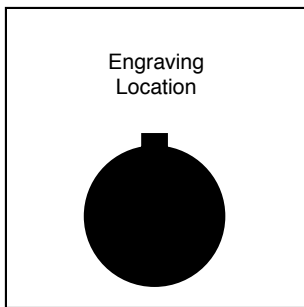

Step 1.

Choose Letter Size - 7/64" or 1/8".

Check the box for the letter size you want. Then write your lettering in box below checkboxes.

Note: 1/8" size letters cannot exceed 16 characters.

7/64"
Letter Size 20 characters max
(for 7/64" size letters)

1/8"
Letter Size 16 characters max
(for 1/8" size letters)

Sample Letter Sizes

3/32" Letters: **A B C D**

1/8" Letters: **A B C D**

Step 2.

Specify Quantity.

Enter the number of nameplates desired in the box on the right.

Qty

1	2	3	4	5	6	7	8	9	10	11	12	13	14	15	16	17	18	19	20
---	---	---	---	---	---	---	---	---	----	----	----	----	----	----	----	----	----	----	----

Switches & Pilot Devices

Signaling Lights

Relays & Sockets

Timers

Contactors

Terminal Blocks

Circuit Breakers

Switch Engraving Order Form – TWND Series

Copy this order form and use it to specify Letter Height, Maximum Number of Lines and Text to be engraved.

To insure engraving accuracy, fax it to your IDEC representative or Distributor.

Your Company: _____
 Name: _____
 Address: _____
 PO: _____

Telephone: _____
 Fax: _____
 Email: _____
 Part Number to be Engraved: _____

Please check one of the boxes below to indicate your choice of engraving options:



ø29mm, ø40mm Mushroom Head



	# of Lines	Letter Height	Max. Characters Per Line
<input type="checkbox"/>	1	5/32	7
<input type="checkbox"/>		1/8	8
<input type="checkbox"/>	2	5/32	7
<input type="checkbox"/>		1/8	8
<input type="checkbox"/>	3	1/8	8
<input type="checkbox"/>	4	Custom*	

*Engraving is possible, but character size will be smaller than standard sizes.

	# of Lines	Letter Height	Max. Characters Per Line
<input type="checkbox"/>	1	3/4	4
<input type="checkbox"/>		5/16	5
<input type="checkbox"/>	2	5/16	5
<input type="checkbox"/>		1/4	6
<input type="checkbox"/>		5/32	8
<input type="checkbox"/>	3	5/32	8
<input type="checkbox"/>		1/8	9
<input type="checkbox"/>	4	1/8	9

	# of Lines	Letter Height	Max. Characters Per Line
<input type="checkbox"/>	Engraving Area 1	5/32	5
<input type="checkbox"/>		1/8	5
<input type="checkbox"/>	Engraving Area 2	5/32	7
<input type="checkbox"/>		1/8	7



- Above mentioned specifications hold true for standard size push-buttons (round and square).
- *Engraving Area 2 can be engraved for 40mm mushroom head non-illuminated pushbutton only.
- Engraving is done on the button itself for non-illuminated push buttons and on marking plate for illuminated push buttons and pilot lights.
- Please enter text exactly how you want it engraved, take care to emphasize capital or small letters.



	# of Lines	Letter Height	Max. Characters Per Line
<input type="checkbox"/>	1	5/32	7
<input type="checkbox"/>		1/8	8
<input type="checkbox"/>	2	5/32	7
<input type="checkbox"/>		1/8	8
<input type="checkbox"/>	3	1/8	8
<input type="checkbox"/>	4	Custom*	

*Engraving is possible, but character size will be smaller than standard sizes.

Enter text to be engraved:

Line 1: _____
 Line 2: _____
 Line 3: _____
 Line 4: _____

Sample Letter Sizes

1/8 Letters: **OPEN**

5/32 Letters: **OPEN**



All engraving is 5/8mm wide.

For IDEC Internal Use Only:

Work Order #: _____

Dimensions (mm)

Pushbutton

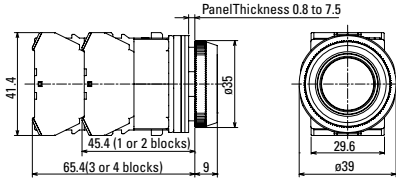

Pushbuttons	Dimension A	Dimension B
Flush	0.351" (9mm)	ø 0.975" (25mm)
Extended	0.566" (14.5mm)	ø 0.975" (25mm)
Extended w/Full Shroud	0.663" (17mm)	ø 1.11" (28.5mm)
Mushroom	0.858" (22mm)	ø 1.56" (40mm)
Mushroom w/Full Shroud	0.936" (24mm)	ø 1.87" (48mm)
Jumbo Mushroom	1.13" (29mm)	ø 2.54" (65mm)
Mushroom, Pushlock Turn Reset and Push-Pull	*0.975" (25mm) **0.975" (25mm)	ø 1.56" (40mm) ø 1.56" (40mm)

Mushroom Pushbutton w/Full Shroud

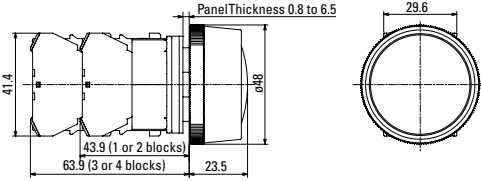

*Dimension when operator is in reset position.
**Dimension when operator is in pull position.

Illuminated Pushbuttons

w/Transformer

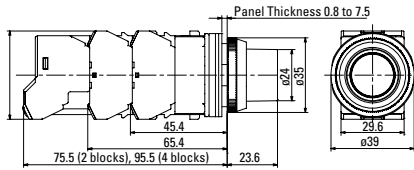

Full Voltage

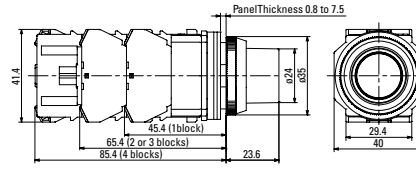

Illuminated Pushbuttons	Dimension A	Dimension B
Flush w/Full Shroud	0.975" (25mm) 0.995" (25.5mm)	ø 0.936" (24mm) ø 0.936" (24mm)
Extended w/Full Shroud	0.741" (19mm) 0.761" (19.5mm)	ø 0.936" (24mm) ø 0.936" (24mm)
ø 1.56" (40mm) Mushroom Pushlock Turn Reset, Push-Pull	*0.975" (25mm) **0.975" (25mm)	ø 1.56" (40mm) ø 1.56" (40mm)



*Dimension when operator is in reset position.
**Dimension when operator is in pull position.

Pilot Lights

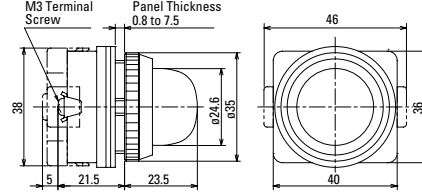

Selector Switches

Knob

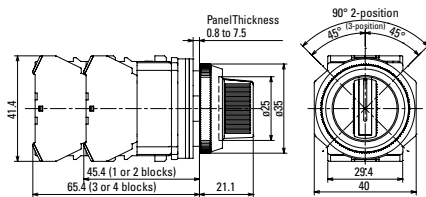

Lever

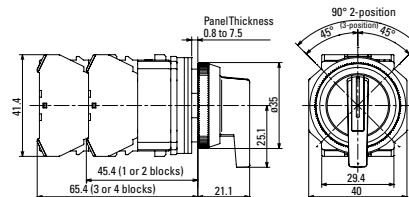

Key

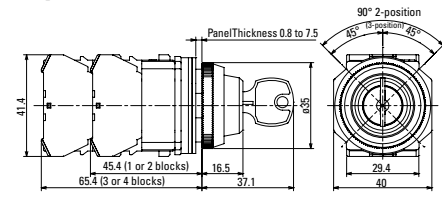

Illuminated Knob

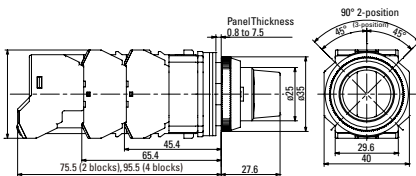

Selector Switches Panel Cut-Out

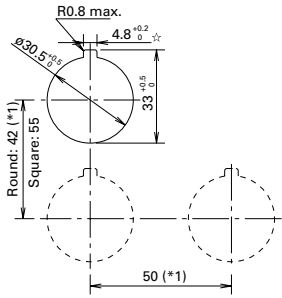

1. *Jumbo Mushroom < 2.61" (66mm)
2. Minimum mounting centers are applicable to switches with one stack of contact blocks. When mounting two stacks of contact blocks, minimum centers should allow for access to wiring.
3. The ø 0.195" (ø 5mm) recess is necessary when either the nameplate or anti-rotation ring is used.

Illuminated Selector Switches

OL-KL1
Lock-Out Adaptor

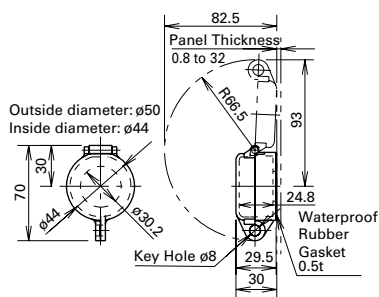

OC-31
Pushbutton Clear Boot

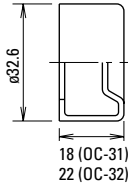

OGL-31
Anti-Rotation Ring

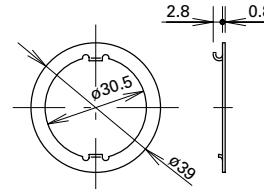

OB-31
Mounting Hole Rubber Plug

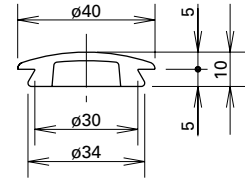

Finger-Safe Cover

N-VL3

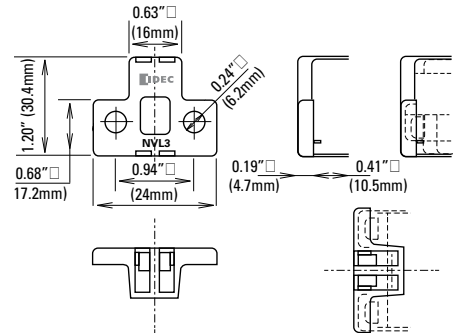

APD-PVL

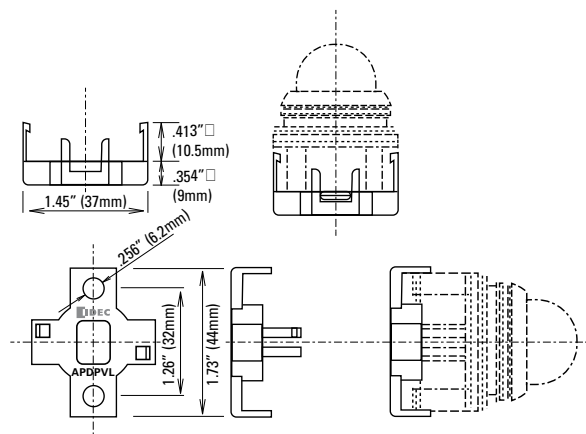

Operating Instructions

Adjustment for Panel Thickness

Each unit is shipped with several waterproof gaskets which are 0.06" (1.5mm) and 0.12" (3mm) thick. Combine the gaskets for a dimension approximately equal to panel thickness and install between the bezel and the body of the unit.

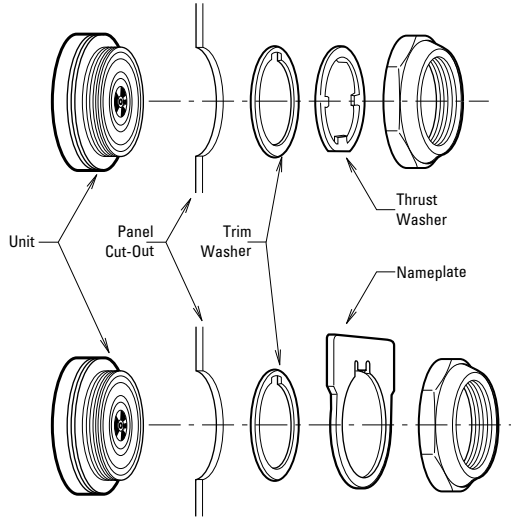

A trim washer must be used with a thrust washer or a nameplate to prevent the control unit from rotating in the mounting hole. When using anti-rotation rings (trim washer with thrust washer or nameplate), install as shown below.

Selector Switches

The operator shaft of each unit has a recess to identify in which direction to install the handle. Align the handle with the recess. Press color insert (TW-HC1) into the Standard Operating Positions.

Standard Operation Positions

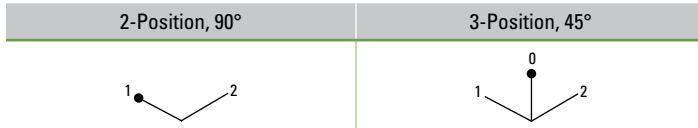

Non-Illuminated 3-Position Operators

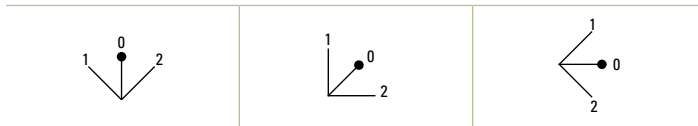

Installation of LED Illuminated Units

Transformer units are recommended for use in areas subjected to inductive noise.

Application Example For Push-To-Test Pilot Light

A typical application of illuminated pushbuttons is a push-to-test pilot light which can be used to check the lamp/LED circuit.

Transformer/AC-Adapter Circuit

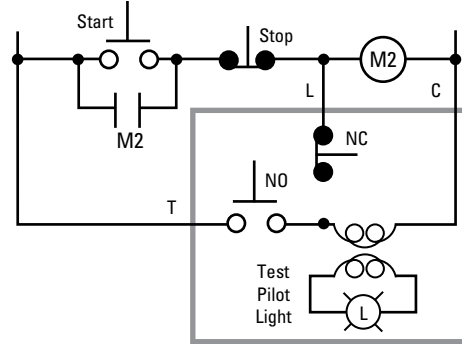

Full Voltage Circuit

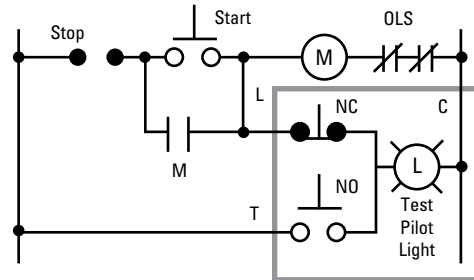

X-ON Electronics

Largest Supplier of Electrical and Electronic Components

Click to view similar products for [Pushbutton Switches](#) category:

Click to view products by [Idec](#) manufacturer:

Other Similar products are found below :

[LW1L-M1C10V-A](#) [LW2L-A1C20M-GD](#) [LW2L-M1C20M-A](#) [60324L](#) [M7E-HRN2](#) [67021K512](#) [67081K512X](#) [701PB580](#) [719-5504-000](#)
[MDPSSGLFS](#) [810KSV30B](#) [FLT 2U EE 01A](#) [MML21KA3ABK](#) [MML23KA3AC05K-001](#) [MML23KW3AA01W](#) [8418K2](#) [8646AB6X718UL](#)
[8646ABUL](#) [FSDWH](#) [9001KXRK](#) [9001T8BK](#) [9533CD4+U574+U4922](#) [1203MRA](#) [A22EM01S](#) [A595](#) [1202A6](#) [12037A2ULCSA](#) [1203A2UL](#)
[ABD122N-B](#) [1211390004](#) [ABN111-Y](#) [ABN400-R](#) [1211500044](#) [1211580012](#) [1212MRA](#) [1232A6NF](#) [RA3CSH6A](#) [1241.1183.7047](#)
[1241.2511](#) [1241.3428](#) [1223A2ULCSA](#) [1223MRA](#) [1232AX2119](#) [1241.1183.8000](#) [1241.1183.8029](#) [1241.2506](#) [1241.2606](#) [12MA6](#)
[1301940184](#) [RELBARF6X10\(PLASTIC\)](#)