

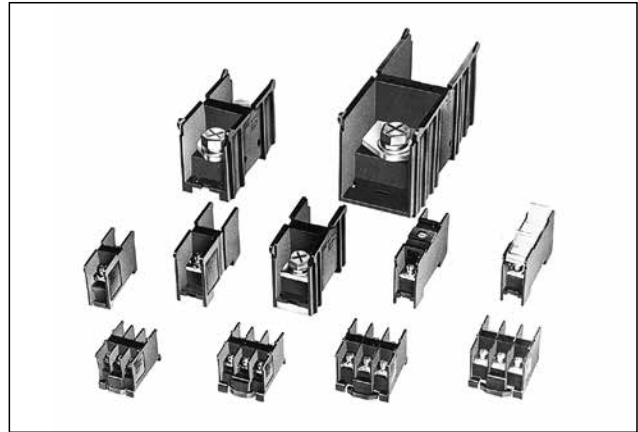

# BA Series Terminal Blocks

**Quick-mount terminal blocks for mounting on 35-mm-wide DIN rails. Current capacities from 16A to 400V (600V).**

- Snaps on to 35-mm-wide DIN rails.
- Wide range of current capacities from 16A to 400A. Insulation voltage is 600V.
- No end plates are required.
- 3-pole units, fuse blocks with blown fuse indicators available.
- Large capacity types (BA811S, BA911S) can be mounted directly to panels.
- Material: PPE (black)
- Complies with JIS C 2811.
- UL recognized and CSA certified. (BA111T, BA211T, BA311T, BA411S, BAF111SU, BAF111SNU)



| Applicable Standards | Mark  | Certification Organization/<br>File No. |
|----------------------|---|---|
| UL1059               |  | UL recognized<br>File No. E78117        |
| CSA 22.2 No. 158     |  | CSA (File No. LR64803)                  |

Quick-mount    Unlatch    No end plates required

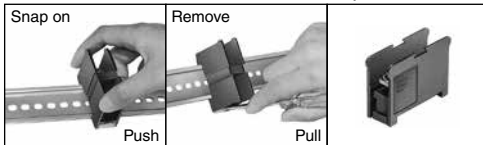

## General Ratings

|                       |                                |
|-----------------------|--------------------------------|
| Dielectric Strength   | 2500V AC, 1 minute             |
| Insulation Resistance | 100MΩ minimum                  |
| Operating Temperature | -25 to +55°C (no freezing)     |
| Storage Temperature   | -25 to 70°C (no freezing)      |
| Operating Humidity    | 45 to 85% RH (no condensation) |

## Terminal Blocks

| Style  | Part No.                   | Ordering No.              | UL/CSA               |                       | JIS             |                              | Terminal Screw   | Tightening Torque (N·m) | Package Quantity |            |    |
|--------|----------------------------|---------------------------|----------------------|-----------------------|-----------------|------------------------------|--|-------------------------|------------------|------------|----|
|        |                            |                           | Voltage/Current      | Wire Size (AWG)       | Voltage/Current | Wire Size (mm <sup>2</sup> ) |  |                         |                  |            |    |
| 3-pole | Self-Lifting               | <b>BA111T</b>             | <b>BA111TPN20</b>    | 300V/15A              | 22-14           | 600V/16A                     | 1.25 mm <sup>2</sup><br>(2 mm <sup>2</sup> )   | M3                      | 0.6 to 1.0       | 20         |    |
|        |                            | <b>BA211T</b>             | <b>BA211TPN20</b>    | 300V/20A              | 22-12           | 600V/21A                     | 2 mm <sup>2</sup><br>(3.5 mm <sup>2</sup> )  | M3.5                    | 1.0 to 1.3       | 20         |    |
|        |                            | <b>BA311T</b>             | <b>BA311TPN20</b>    | 150V/30A              | 18-10           | 600V/40A                     | 5.5 mm <sup>2</sup>  | M4                      | 1.4 to 2.0       | 20         |    |
| 1-pole | Self-Lifting               | <b>BA411S</b>             | <b>BA411SPN50</b>    | 600V/40A              | 16-6            | 600V/70A                     | 14 mm <sup>2</sup>   | M5                      | 2.6 to 3.7       | 50         |    |
|        |                            | <b>BA611S</b>             | <b>BA611SPN10</b>    | —                     | —               | 600V/94A                     | 22 mm <sup>2</sup>   | M6                      | 3.9 to 5.4       | 10         |    |
|        |                            | <b>BA711S</b>             | <b>BA711SPN06</b>    | —                     | —               | 600V/132A                    | 38 mm <sup>2</sup>   | M8                      | 10 to 13.5       | 6          |    |
|        | Large Capacity             | <b>BA811S</b>             | <b>BA811SPN06</b>    | —                     | —               | 600V/240A                    | 100 mm <sup>2</sup>  | M10                     | 21 to 28         | 6          |    |
|        |                            | <b>BA911S</b>             | <b>BA911SPN06</b>    | —                     | —               | 600V/370A                    | 200 mm <sup>2</sup><br>(200 mm <sup>2</sup> 2 wires)<br>(325 mm <sup>2</sup> 1 wire) | M12                     | 38 to 49         | 6          |    |
|        |                            | Fuse                      | <b>BAF111S-□</b>     | <b>BAF111S-□PN20</b>  | —               | —                            | 600V/10A   | 5.5 mm <sup>2</sup>     | M4               | 1.4 to 2.0 | 20 |
|        |                            | Fuse with Lamp            | <b>BAF111SN-□</b>    | <b>BAF111SN-□PN20</b> | —               | —                            | 600V/10A   | 5.5 mm <sup>2</sup>     | M4               | 1.4 to 2.0 | 20 |
|        | Without Fuse/<br>With Lamp | <b>BAF111SU</b>           | <b>BAF111SUPN20</b>  | 600V/10A              | 18-10           | 600V/10A                     | 5.5 mm <sup>2</sup>  | M4                      | 1.4 to 2.0       | 20         |    |
|        |                            | <b>BAF111SNU</b>          | <b>BAF111SNUPN20</b> | 600V/10A              | 18-10           | 600V/10A                     | 5.5 mm <sup>2</sup>  | M4                      | 1.4 to 2.0       | 20         |    |
|        |                            | With Disconnecting Switch | <b>BAT20</b>         | <b>BAT20PN20</b>      | —               | —                            | 600V/20A   | 5.5 mm <sup>2</sup>     | M4               | 1.4 to 2.0 | 20 |

1. Specify fuse ratings 1A, 3A, or 5A in place of □ in the Part No.
2. The wire size in ( ) does not comply with JIS standards.
3. The voltage/current differ according to operating conditions. See "Selecting Terminal Blocks by Current According to JIS Standards" on page 4.
4. Use a socket wrench or screwdriver for tightening screws.

○: Order when a marking strip or a dust cover is needed.

▲: Used for surface mounting

\*: Dust cover with fuse holder

| Part No.   | Accessories (× Necessary) |          |               |            |                |                |                       |
|--|---------------------------|----------|---------------|------------|----------------|----------------|-----------------------|
|  | DIN Rail                  | End Clip | Marking Strip | Dust Cover | Connecting Rod | Connecting Nut | Surface Mounting Clip |
| <b>BA111T, BA411S, BAT20, BA211T, BA611S, BA711S, BA311T</b> | ×                         | ×        | ○             | ○          | —              | —              | —                     |
| <b>BA811S, BA911S</b>  | ×                         | ×        | ○             | ○          | ×              | ×              | ▲                     |
| <b>BAF111S□, BAF111SN□, BAF111SU, BAF111SNU</b>              | ×                         | ×        | ○             | *          | —              | —              | —                     |

## Material

| Parts Name     | Material                   |
|----------------|----------------------------|
| Housing        | Polyamide                  |
| Bus Bar        | Brass (nickel-plated)      |
| Terminal Screw | Steel (zinc chrome-plated) |

# BA Series Terminal Blocks

## BA111T (3 Pole) 16A M3

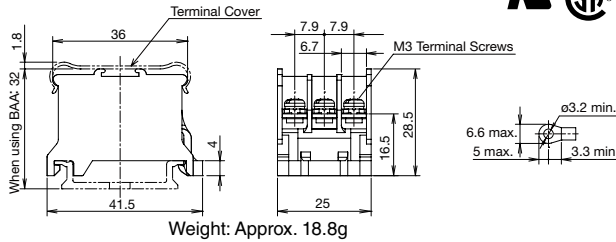

| Standards             | UL/CSA              | JIS                                       |
|-----------------------|---------------------|---|
| Insulation Voltage    | 300V                | 600V                                      |
| Rated Current *2      | 15A max.            | 16A                                       |
| Dielectric Strength   | 2,500V AC, 1 minute |   |
| Insulation Resistance | 100 MΩ minimum      |   |
| Wire Size *1          | 22-14 AWG           | 1.25 mm <sup>2</sup> (2 mm <sup>2</sup> ) |
| Accessories           | Marking Strip Width | 9.5 mm (BNM7, BNM9, BNM725)               |
|                       | Dust Cover          | BNC220                                    |
|                       | Rail                | BAP1000, BAA1000                          |
|                       | See page            | 31  |

## BA211T (3 Pole) 21A M3.5

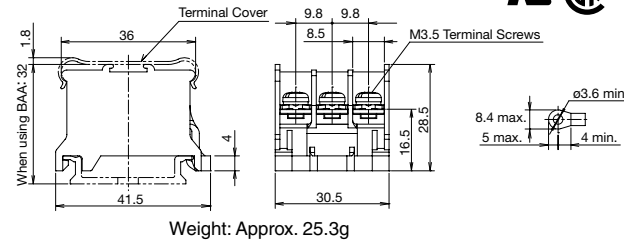

| Standards             | UL/CSA              | JIS                                      |
|-----------------------|---------------------|--|
| Insulation Voltage    | 300V                | 600V                                     |
| Rated Current *2      | 20A max.            | 21A                                      |
| Dielectric Strength   | 2,500V AC, 1 minute |  |
| Insulation Resistance | 100 MΩ minimum      |  |
| Wire Size *1          | 22-12 AWG           | 2 mm <sup>2</sup> (3.5 mm <sup>2</sup> ) |
| Accessories           | Marking Strip Width | 9.5 mm (BNM7, BNM9, BNM725)              |
|                       | Dust Cover          | BNC220                                   |
|                       | Rail                | BAP1000, BAA1000                         |
|                       | See page            | 31                                       |

## BA311T (3 Pole) 40A M4

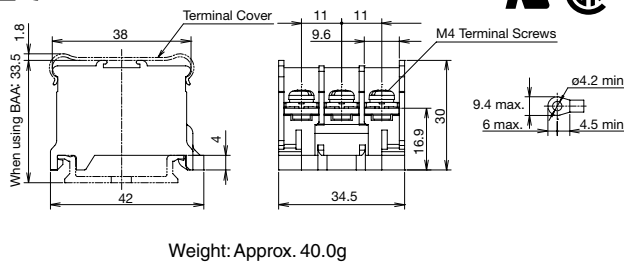

| Standards             | UL/CSA              | JIS                         |
|-----------------------|---------------------|-----------------------------|
| Insulation Voltage    | 150V                | 600V                        |
| Rated Current *2      | 30A max.            | 40A                         |
| Dielectric Strength   | 2,500V AC, 1 minute |                             |
| Insulation Resistance | 100 MΩ minimum      |                             |
| Wire Size *1          | 18-10 AWG           | 5.5 mm <sup>2</sup>         |
| Accessories           | Marking Strip Width | 9.5 mm (BNM7, BNM9, BNM725) |
|                       | Dust Cover          | BNC230                      |
|                       | Rail                | BAP1000, BAA1000            |
|                       | See page            | 31                          |

## BA411S 70A M5

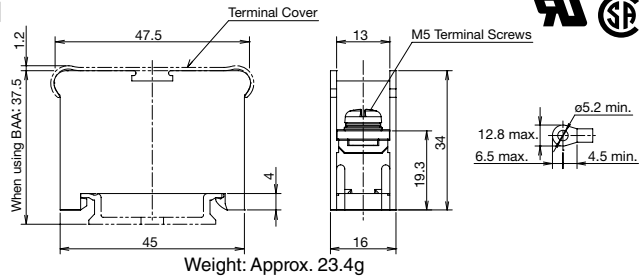

| Standards             | UL/CSA              | JIS                         |
|-----------------------|---------------------|-----------------------------|
| Insulation Voltage    | 600V                | 600V                        |
| Rated Current *2      | 40A max.            | 70A                         |
| Dielectric Strength   | 2,500V AC, 1 minute |                             |
| Insulation Resistance | 100 MΩ minimum      |                             |
| Wire Size *1          | 16-6 AWG            | 14 mm <sup>2</sup>          |
| Accessories           | Marking Strip Width | 9.5 mm (BNM7, BNM9, BNM725) |
|                       | Dust Cover          | BNC320                      |
|                       | Rail                | BAP1000, BAA1000            |
|                       | See page            | 31                          |

## BA611S 94A M6

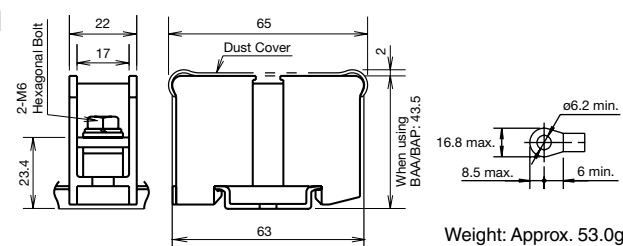
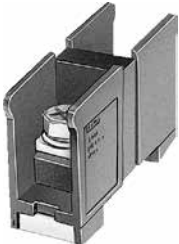

Socket wrench: 12.7 mm square drive hexagonal socket 10 \*3

|                       |                     |                             |
|-----------------------|---------------------|-----------------------------|
| Insulation Voltage    | 600V                |                             |
| Rated Current *2      | 94A max.            |                             |
| Dielectric Strength   | 2,500V AC, 1 minute |                             |
| Insulation Resistance | 100 MΩ minimum      |                             |
| Wire Size             | 22 mm <sup>2</sup>  |                             |
| Accessories           | Marking Strip Width | 9.5 mm (BNM7, BNM9, BNM725) |
|                       | Dust Cover          | BNC520                      |
|                       | Rail                | BAP1000, BAA1000            |
|                       | See page            | 31                          |

## BA711S 132A M8

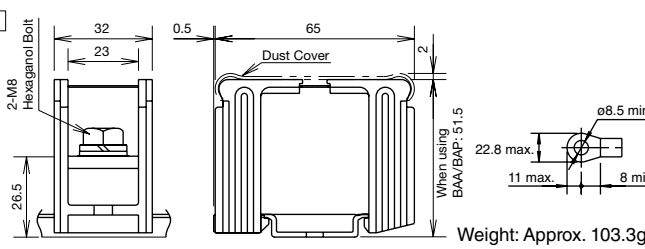
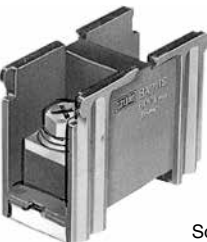

Socket wrench: 12.7 mm square drive hexagonal socket 13 \*3

|                       |                     |                             |
|-----------------------|---------------------|-----------------------------|
| Insulation Voltage    | 600V                |                             |
| Rated Current *2      | 132A max.           |                             |
| Dielectric Strength   | 2,500V AC, 1 minute |                             |
| Insulation Resistance | 100 MΩ minimum      |                             |
| Wire Size             | 38 mm <sup>2</sup>  |                             |
| Accessories           | Marking Strip Width | 9.5 mm (BNM7, BNM9, BNM725) |
|                       | Dust Cover          | BNC520                      |
|                       | Rail                | BAP1000, BAA1000            |
|                       | See page            | 31                          |

\*1: The wire size in ( ) does not comply with JIS standards.

\*2: The voltage/current differ according to operating conditions. See "Selecting Terminal Blocks by Current According to JIS Standards" on page 4.

\*3: Screws can be tightened with a socket wrench.

\*4: The grooves on the head of the hex bolt are for temporary tightening. For proper tightening, use an applicable socket wrench and tighten within the range of the recommended tightening torque.

# BA Series Terminal Blocks

## BA811S 240A M10



Socket wrench: 12.7 mm square drive hexagonal socket 17

Weight: Approx. 185.0g

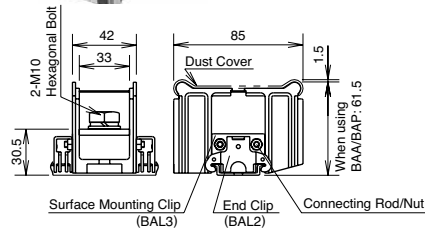

## BA911S 370A M12



Socket wrench: 12.7 mm square drive hexagonal socket 19

Weight: Approx. 406.3g

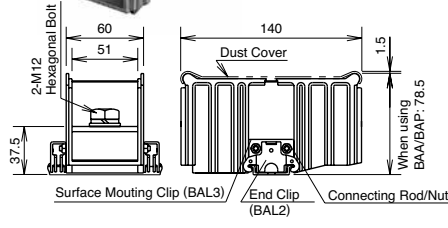

### Surface Mounting

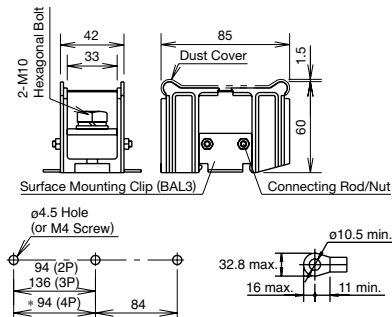

\*Use 3 surface mounting clips (BAL3) for 4-pole mounting

### Surface Mounting

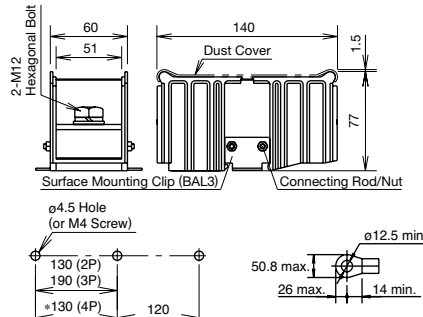

\*Use 3 surface mounting clips (BAL3) for 4-pole mounting

| Part No.              | BA811S                                | BA911S  |
|-----------------------|---------------------------------------|---|
| Insulation Voltage    | 600V                                  |   |
| Rated Current *2      | 240A                                  | 370 (400A)  |
| Dielectric Strength   | 2,500V AC, 1 minute                   |   |
| Insulation Resistance | 100MΩ minimum                         |   |
| Wire Size             | 100 mm <sup>2</sup>                   | 200 mm <sup>2</sup> *1<br>(200 mm <sup>2</sup><br>2 wires)<br>(325 mm <sup>2</sup><br>1 wire) |
| Terminal Screw        | M10                                   | M12   |
| Accessories           | Connecting Rod                        | BNR1, BNR2, BNL8  |
|                       | Connecting Nut                        | BAN1  |
|                       | End Clip/<br>Surface Mounting<br>Clip | BAL2, BAL3  |
|                       | Marking Strip<br>Width                | 9.5 mm (BNM7, BNM9,<br>BNM725)  |
|                       | Dust Cover                            | BAC820 BNC92  |
|                       | Rail                                  | BAP1000, BAA1000  |
| See page              | 31                                    |   |

## BAF111S (Fuse) 10A M4

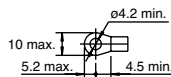
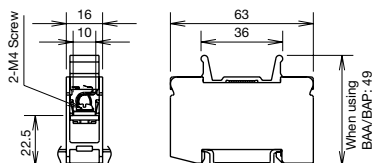

• BAF111SN is equipped with a neon lamp (for 100 or 200V AC) which turns on when the fuse is blown.

### Internal Connection

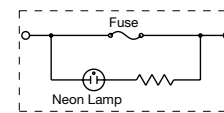

### BAF111S (with fuse)/BAF111SN (with fuse/lamp)

|                       |                                      |                               |
|-----------------------|--------------------------------------|-------------------------------|
| Insulation Voltage    | 600V                                 |                               |
| Rated Current         | 10A max.<br>(depends on fuse rating) |                               |
| Dielectric Strength   | 2,500V AC, 1 minute                  |                               |
| Insulation Resistance | 100MΩ minimum                        |                               |
| Wire Size             | 5.5 mm <sup>2</sup>                  |                               |
| Terminal Screw        | M4                                   |                               |
| Accessories           | Marking Strip Width                  | 9.5mm (BNM7, BNM9,<br>BNM725) |
|                       | Dust Cover                           | —                             |
|                       | Rail                                 | BAP1000, BAA1000              |
|                       | See page                             | 31                            |

• Fuse ratings  
Rated voltage: 250V  
Rated current: 1, 3, 5A  
Cartridge fuse: JIS C6575-2  
6.35×31.8 mm

Part No.  
BAF111S-1A  
BAF111S-3A  
BAF111S-5A  
BAF111SN-1A  
BAF111SN-3A  
BAF111SN-5A

### BAF111S (with fuse)/BAF111SN (without fuse/with lamp)

|                       |                                      |                                |
|-----------------------|--------------------------------------|--------------------------------|
| Insulation Voltage    | 600V                                 |                                |
| Rated Current         | 10A max.<br>(depends on fuse rating) |                                |
| Dielectric Strength   | 2,500V AC, 1 minute                  |                                |
| Insulation Resistance | 100 MΩ minimum                       |                                |
| Wire Size             | 18-10 AWG                            |                                |
| Terminal Screw        | M4                                   |                                |
| Accessories           | Marking Strip Width                  | 9.5 mm (BNM7, BNM9,<br>BNM725) |
|                       | Dust Cover                           | —                              |
|                       | Rail                                 | BAP1000, BAA1000               |
|                       | See page                             | 31                             |

• Use UL/CSA approved fuses (10A maximum)  
• Fuse size  
6.35×31.8 mm  
6.40×30 mm

## BAT20 (With Disconnecting Switch) 20A M4

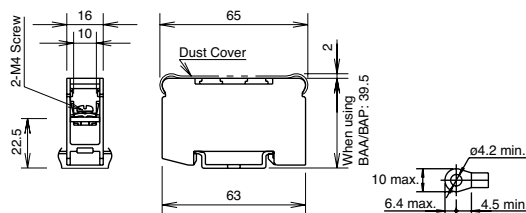
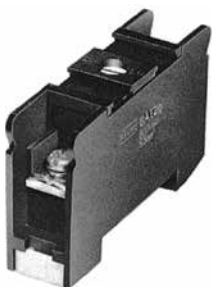

|                       |                          |                     |
|-----------------------|--------------------------|---------------------|
| Insulation Voltage    | 600V                     |                     |
| Rated Current         | 20A                      |                     |
| Dielectric Strength   | 2,500V AC, 1 minute      |                     |
| Insulation Resistance | 100 MΩ minimum           |                     |
| Wire Size             | 5.5 mm <sup>2</sup> max. |                     |
| Terminal Screw        | M4                       |                     |
| Accessories           | Marking Strip Width      | 9.5 mm (BNM7, BNM9) |
|                       | Dust Cover               | BNC520              |
|                       | Rail                     | BAP1000, BAA1000    |
|                       | See page                 | 31                  |

BAT20 is not capable of breaking circuits. Do not apply voltage when opening or closing the circuit. Turn the slot using a screwdriver.

\*1: The wire size in ( ) does not comply with JIS standards.

\*2: The rated current differs according to operating conditions. See "Selecting Terminal Blocks by Current According to JIS Standards" on page 4.

\*3: The grooves on the head of the hex bolt are for temporary tightening. For proper tightening, use an applicable socket wrench and tighten within the range of the recommended tightening torque.

## Accessories

### Rails

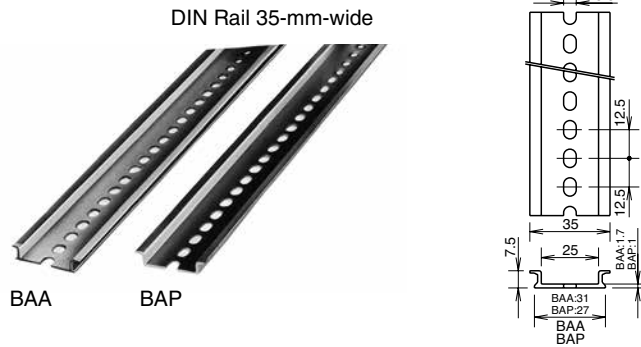

| Length  | Part No.              | Ordering No.       | Material | Weight (Approx.) | Package Quantity |
|---------|-----------------------|--------------------|----------|------------------|------------------|
| 1000 mm | <b>BAA1000</b> (Note) | <b>BAA1000PN10</b> | Aluminum | 200g             | 10               |
|         | <b>BAP1000</b>        | <b>BAP1000PN10</b> | Steel    | 320g             | 10               |

Note: 2000 mm is also available. Contact IDEC.

### Marking Strip (BNM)

| Part No.      | Ordering No.    | Package Quantity | Dimensions       | Material                    |
|---------------|-----------------|------------------|------------------|-----------------------------|
| <b>BNM7</b>   | <b>BNM7PN10</b> | 10               | 9.5 × 0.5t × 1m  | PVC (glossy surface)        |
| <b>BNM9</b>   | <b>BNM9PN10</b> | 10               | 9.5 × 0.5t × 1m  | Fiber Glass (matte surface) |
| <b>BNM725</b> | <b>BNM725</b>   | 1                | 9.5 × 0.5t × 25m | PVC (glossy surface)        |

### End Clip

Used on the ends of a group of terminal blocks to secure and prevent sliding along the rails.

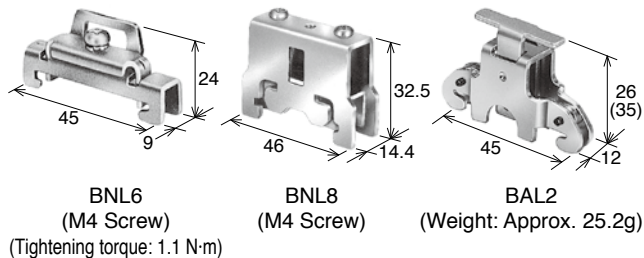

Material: Steel (zinc chrome-plated)

| Part No.    | Ordering No.    | Package Quantity |
|-------------|-----------------|------------------|
| <b>BNL6</b> | <b>BNL6PN10</b> | 10               |
| <b>BNL8</b> | <b>BNL8PN10</b> | 10               |
| <b>BAL2</b> | <b>BAL2PN10</b> | 10               |

### Notes on Selecting End Clips

- When using BA611S, use BAL2 or BNL8. Also, when using BA711S, BA811S, BA911S of 100A or larger, use BAL2 or BNL8.
- When mounting rails vertically, use BAL2 or BNL8.

### Dust Cover

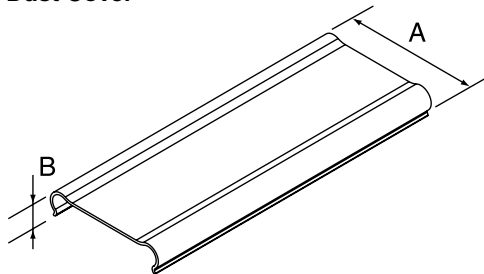

Material: Polycarbonate

| Item                | Part No.      | Ordering No.      | Size (mm) |      | Terminal Block        | Package Quantity |
|---------------------|---------------|-------------------|-----------|------|-----------------------|------------------|
|                     |               |                   | A         | B    |                       |                  |
| Dust Cover (1m)     | <b>BNC220</b> | <b>BNC220PN10</b> | 37.6      | 8.5  | BA111T, BA211T        | 10               |
|                     | <b>BNC230</b> | <b>BNC230PN10</b> | 39.6      | 8.5  | BA311T                | 10               |
|                     | <b>BNC320</b> | <b>BNC320PN10</b> | 49.6      | 8.5  | BA411S                | 10               |
|                     | <b>BNC520</b> | <b>BNC520PN10</b> | 65.0      | 9.0  | BA611S, BA711S, BAT20 | 10               |
|                     | <b>BAC820</b> | <b>BAC820PN10</b> | 85.0      | 10.6 | BA811S                | 10               |
| Dust Cover (500 mm) | <b>BNC92</b>  | <b>BNC92PN10</b>  | 140.5     | 9.8  | BA911S                | 10               |

# BA Series Terminal Blocks

## Connecting Rod/Connecting Nut (For BA811S, BA911S)



BNR1: M4 × 0.7 L = 265 (21.0g)  
BNR2: M4 × 0.7 L = 500 (43.0g)



BAN1: M4 × 0.7 (2.5g)

| Item                       | Part No.    | Ordering No.    | Weight (Approx.) | Package Quantity | Remarks  |
|----------------------------|-------------|-----------------|------------------|------------------|----------|
| Connecting Rod (265 mm)    | <b>BNR1</b> | <b>BNR1PN10</b> | 2.6g             | 10               | M4 × 0.7 |
| Connecting Rod (500 mm)    | <b>BNR2</b> | <b>BNR2PN10</b> | 43g              | 10               | M4 × 0.7 |
| Connecting Nut (4 pcs/set) | <b>BAN1</b> | <b>BAN1PN10</b> | 2.5g             | 10               | M4 × 0.7 |

## Surface Mounting Clip (For BA811S and BA911S Only)



Used on the ends of groups of terminal blocks for direct mounting to panels.

Material: Steel (zinc-chrome plated)

| Part No.    | Ordering No.    | Weight (approx.) | Package Quantity |
|-------------|-----------------|------------------|------------------|
| <b>BAL3</b> | <b>BAL3PN10</b> | 12.4g            | 10               |

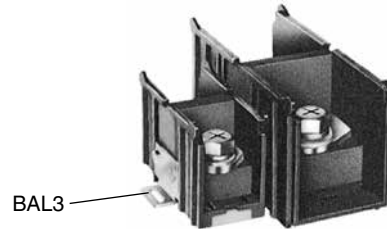

## Calculating Rail / Connecting Rod Length

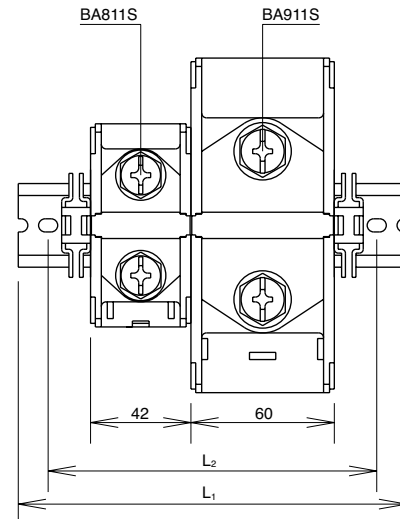
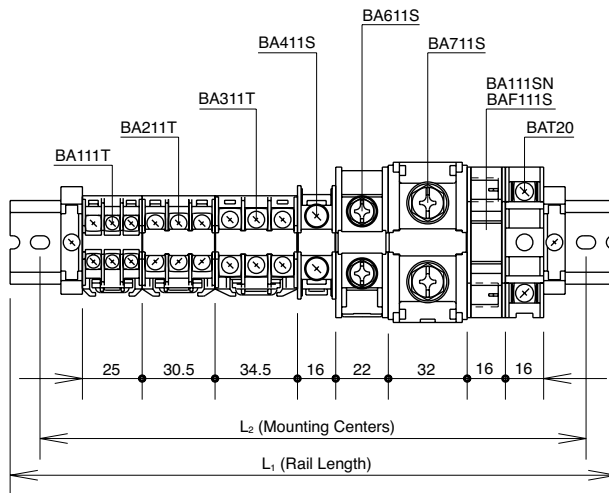

### Calculating Rail Length

For BAA, BAP rails

$$L_1 = 12.5 \times N$$

$$L_2 = L_1 - 25$$

A: Total thickness of each terminal block

B: Tolerance of stacking thickness

0.1 mm per block

C: End Clip

When using 2 pieces of BNL6 or BAL2 = 62.5

N: Rounded up numerical number from the calculated value of M.

(Example: N for 19.1 is 20)

$$M = \frac{A + B + C}{12.5}$$

Note: This formula is for calculating the maximum rail length including tolerance. The rail length may be shorter than the calculated value, depending on how the terminal blocks are combined.

### Calculating Connecting Rod Length

$$L = 42 \times n_1 + 60 \times n_2 + 10.2$$

n<sub>1</sub>: BA811S

n<sub>2</sub>: BA911S

n: The number of terminal blocks

## Instructions

### Installation of BA811S and BA911S

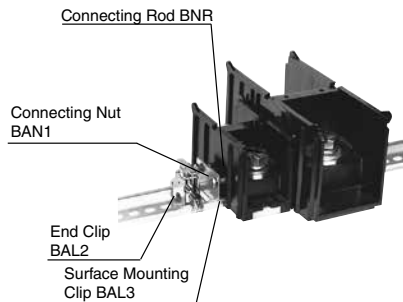

#### Rail Mount

1. Mount the terminal block on DIN rail.
2. Mount the surface mounting clips (BAL3) on both ends and slide 2 connecting rods (BNR) through the holes in the terminal blocks.
3. Tighten both ends of the connecting rod with a connecting nut (BAN1).
4. Secure the terminal blocks with end clips (BAL2).

#### Surface Mount

1. Mount the terminal block to the panel.
2. Mount the surface mounting clips (BAL3) on both ends and slide 2 connecting rods (BNR) through the holes in the terminal blocks.
3. Tighten both ends of the connecting rod with connecting nuts (BAN1).
4. Secure the terminal blocks to the panel.

### Notes on Wiring

#### Crimping Terminals

- When using crimping terminals, be sure to use insulated terminals to prevent electric shocks.

#### Without Crimping Terminals

- Insert the wire until the insulation comes into contact with the terminal metal part.
- Strip the insulation so that the wire is longer than the width of the wire clamp.
- When connecting two wires, use wires of the same size.

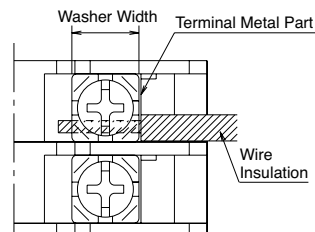

## **X-ON Electronics**

Largest Supplier of Electrical and Electronic Components

*Click to view similar products for [Fixed Terminal Blocks](#) category:*

*Click to view products by [Idec](#) manufacturer:*

Other Similar products are found below :

[00175550202](#) [MBE-1512](#) [MBE-1520](#) [MBE-154](#) [MBE-156](#) [MBES-1510](#) [MBES-153](#) [MBES-156](#) [MH-2512](#) [MHE-132](#) [MHE-133](#) [MHE-163](#)  
[MI-254 \(35\)](#) [MI-272](#) [8739](#) [880507](#) [880508](#) [MPT-275](#) [1546551-6](#) [ELM023100](#) [ELM10110G](#) [ELVD12100](#) [BA311TU](#) [BA411SU](#) [MV-152](#)  
[MV-253/NCNOC](#) [MV-254-D](#) [MV-255](#) [MV-462](#) [MV-472](#) [MV-493](#) [MVE-252](#) [MVE-253](#) [MVE-258](#) [MVE-273](#) [MVEB-153](#) [1700096](#)  
[1702246](#) [1705142](#) [1712417](#) [1713020](#) [1713088](#) [1776118-2](#) [1790852](#) [1-796689-8](#) [1-796692-6](#) [1800001](#) [1800114](#) [1823215](#) [1838462](#)