

## MicroSmart



UL Listed  
File No. E211795

### Key features of the MicroSmart series include:

- 10, 16, or 24 I/O All-in-one type CPU modules with Sink/Source DC input and Relay Output
- 20 I/O Slim type CPU modules with Sink/Source DC input and Transistor Sink or Source Output
- 20 I/O Slim type CPU modules with Sink/Source DC input and Relay Output with high-speed Transistor Sink or Source Output
- 40 I/O Slim type CPU modules with Sink/Source DC input and Transistor Sink or Source Output
- AC Input, DC Input, Relay Output, Transistor Output, Combination I/O and Analog I/O expansion modules available
- 24 I/O All-in-one CPU expandable to 88 I/O points; 20 I/O slim types expandable up to 148 or 244 I/O; 40 I/O slim type expandable up to 264 I/O points
- Standard RS232 port, optional plug-in RS485/RS232 port
- Optional memory cartridge or real-time clock and calendar cartridge
- Data link to other MicroSmart modules, PLCs, PCs or HG series operator interfaces
- Approved for Class 1–Div. 2 hazardous locations (UL1604)
- Compact size

### Pulse Output/Trapezoidal Control

Independent dual-axis control is available with two pulse outputs. Locational values can be easily defined for precise positional (trapezoidal) control.

- Pulse output instruction
- PWM instruction (Pulse Width Modulation control)

### Pulse Output Function Specifications

Number of output points	2
Maximum output frequency	20 kHz

\*Only one point of trapezoidal control is available.

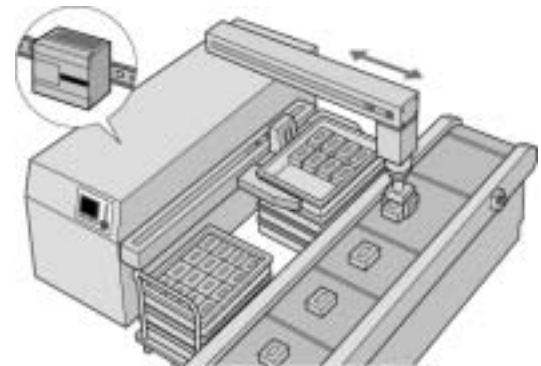

Setting the desired values enables you to precisely manage the trapezoidal control

Operation mode (S1)	1
Steady pulse frequency (S1 + 1)	50
Initial pulse frequency (S1 + 2)	10
Frequency change rate (S1 + 3)	2
Present value (S1 + 6, 7)	10,000

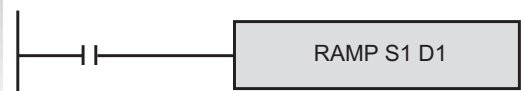
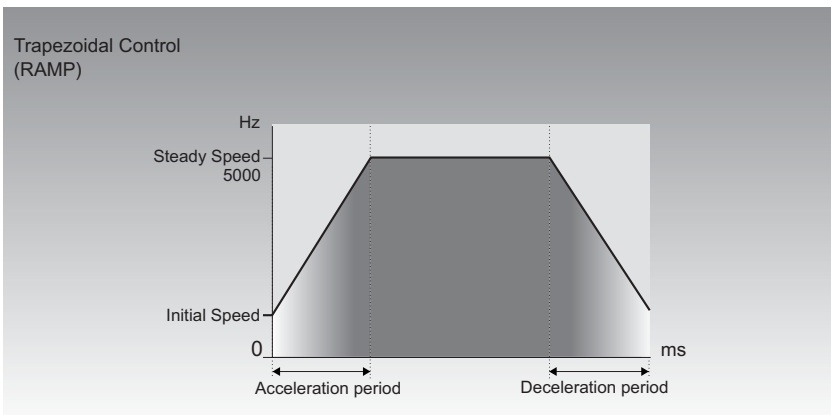

J Programmable Logic Controllers

**CPU and Module Combination Examples**

**All-In-One Type**

- Attach Maximum 4 Expansion Modules
- Maximum I/O 88 points
- Only FC4A-C24R2/C24R2C CPU Module is expandable



The maximum number of relay outputs that can be turned on simultaneously is 33 points including relay outputs on the CPU module.

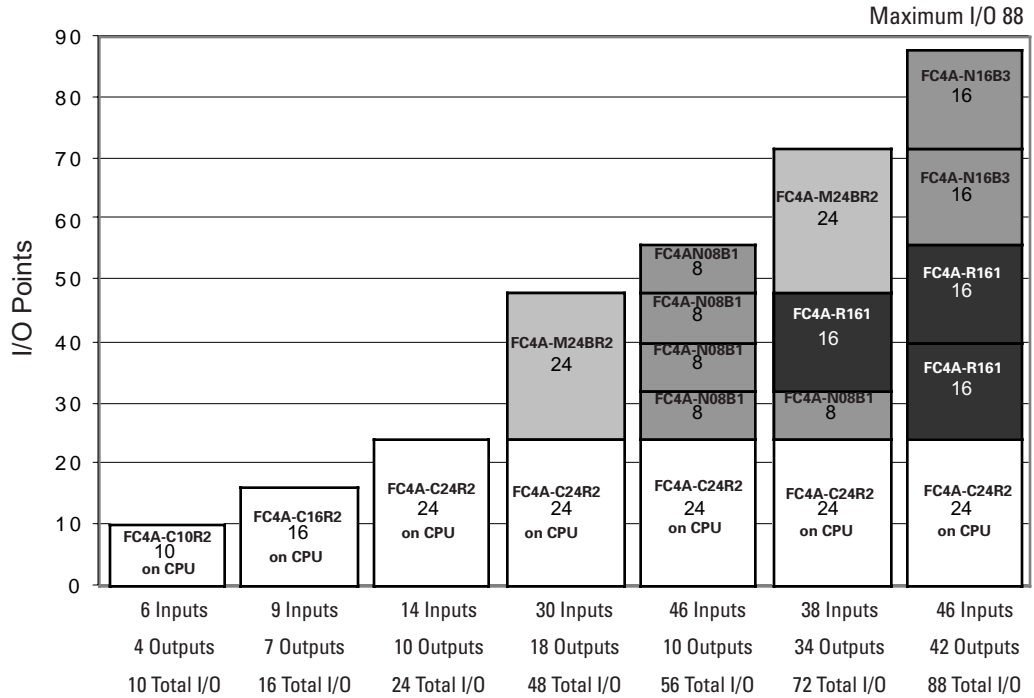

**Slim Type**



Programmable Logic Controllers

- Attach Maximum 7 Expansion Modules
- Maximum I/O
  - 148 points (D20K3, D20S3)
  - 244 points (D20RK1, D20RS1)
  - 264 points (D40K3, D40S3)



The maximum number of relay outputs that can be turned on simultaneously is 54 points including relay outputs on the CPU module.

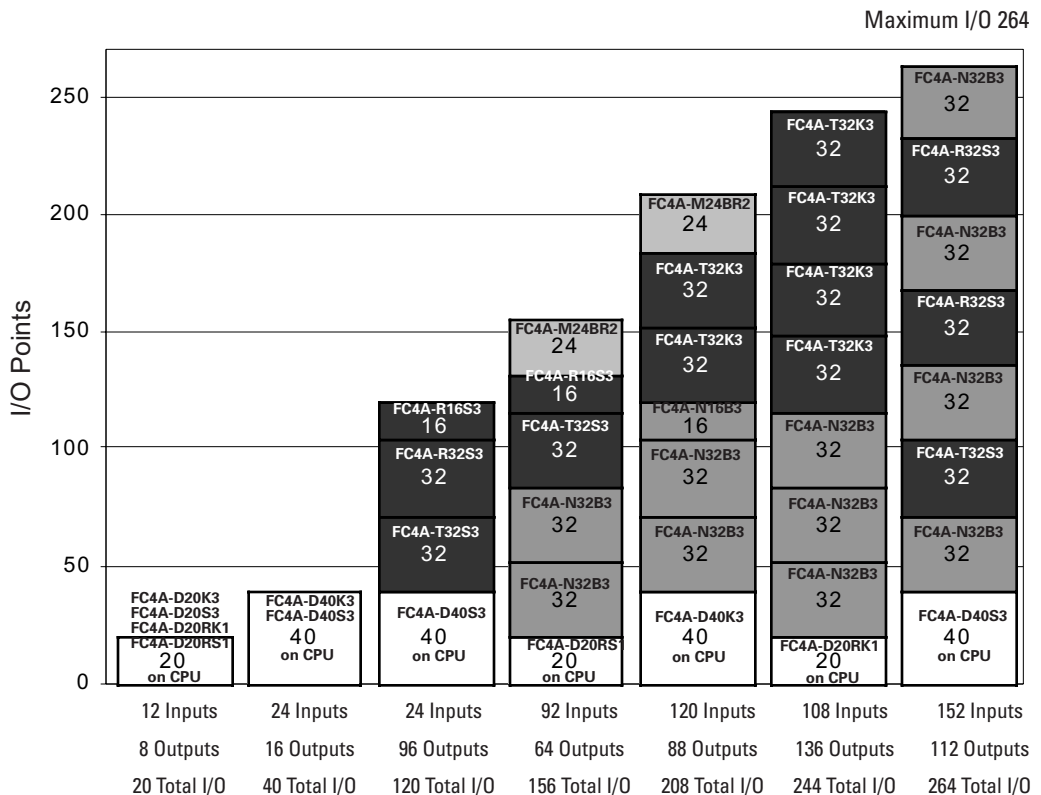

## PID Control

To automatically maintain a target water temperature (PID control), use the auto tuning function to perform sampling. Based on the determined PID parameters, PID control is executed automatically. (Slim type CPU units only.)

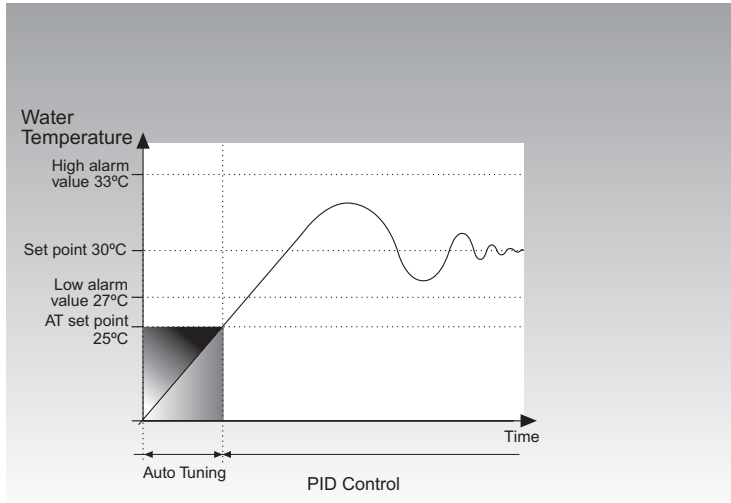

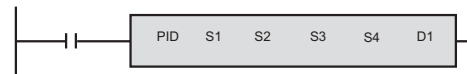

Set point	30
AT set point	25
High alarm value	35
Low alarm value	27



## CPU Modules - All-in-One Type

### Part Numbers



AC Power Type	FC4A-C10R2*	FC4A-C16R2*	FC4A-C24R2
DC Power Type	FC4A-C10R2C*	FC4A-C16R2C*	FC4A-C24R2C
Item			
I/O Points	10 (6 in/ 4 out)	16 (9 in/7 out)	24 (14 in/10 out)
Output Type	Relay Output, 240V AC/30V DC, 2A		
Input Type	24V DC (Sink/Source)		
Power Voltage	AC	100-240V AC, 50/60 Hz	
	DC	24V DC	
Memory	4.8KB	15KB	27KB
Expandability	N/A*	N/A	88 maximum I/O (up to 4 expansion I/O modules)



**J** Programmable Logic Controllers



- \* I/O expansion modules not applicable to these two models.
- For specifications see page J-15 & for dimensions see page J-25.
- For options see J-11 & for accessories see J-12.

**CPU Modules - Slim Type**

Part Number	FC4A-D20K3	FC4A-D20RK1	FC4A-D40K3
Item			
I/O Points	20 (12 in/ 8 out)*	20 (12 in/ 8 out)	40 (24 in/16 out)**
Output Type	Transistor Sink Output 0.3A	Relay Output, 240V AC/30V DC, 2A* Sink Output 0.3A*	Transistor Sink Output 0.3A
Input Type	24V DC (Sink/Source)		
Power Voltage	24V DC		
Memory	27KB	31.2KB	31.2KB
Expandability	148 maximum I/O (up to 7 expansion modules)	244 maximum I/O (up to 7 expansion modules)	264 maximum I/O (up to 7 expansion modules)

Part Number	FC4A-D20S3	FC4A-D20RS1	FC4A-D40S3
Item			
I/O Points	20 (12 in/ 8 out)*	20 (12 in/ 8 out)	40 (24 in/16 out)**
Output Type	Transistor Source Output 0.3A	Relay Output, 240V AC/30V DC, 2A* Transistor, Source Output 0.3A*	Transistor Source Output 0.3A
Input Type	24V DC (Sink/Source)		
Power Voltage	24V DC		
Memory	27KB	31.2KB	31.2KB
Expandability	148 maximum I/O (up to 7 expansion modules)	244 maximum I/O (up to 7 expansion modules)	264 maximum I/O (up to 7 expansion modules)







1. \* Transistor output 2 points and relay output 6 points.
2. \*\*For MIL connector type modules, see page J-12 for cables and breakout modules.
3. For specifications see page J-15 & for dimensions see page J-25.
4. For options see J-11 & for accessories see J-12.

**J**

**Programmable Logic Controllers**









## Input Modules - 5 Types

Part Number	FC4A-N08B1	FC4A-N16B1	FC4A-N16B3	FC4A-N32B3	FC4A-N08A11
Item					
Input Points	8-point DC	16-point DC	16-point DC*	32-point DC*	8-point AC
Input Type	24V DC (Sink/Source)				100 - 120V AC
Power Voltage	24V DC				100 - 120V AC (50/60Hz)
Terminal	Removable screw terminal	Removable screw terminal	MIL connector	MIL connector	Removable screw terminal



1. For specifications see page J-19 & for dimensions see page J-25.
2. For options see J-11 & for accessories see J-12.
3. \*For MIL connector type modules, see page J-12 for cables and breakout modules.



## Output Modules - 8 Types

Part Number	FC4A-R081	FC4A-R161	FC4A-T08K1	FC4A-T08S1
Item				
Output Points	8-point Relay	16-point Relay	8-point Transistor	8-point Transistor
Output Type	Relay Output (1NO contact), 240V AC/30V DC, 2A		Transistor sink output 0.3A	Transistor Source Output 0.3A
Terminal	Removable screw terminal			
Part Number	FC4A-T16K3	FC4A-T16S3	FC4A-T32K3	FC4A-T32S3
Item				
Output Points	16-point Transistor	16-point Transistor	32-point Transistor	32-point Transistor
Output Type	Transistor sink output 0.1A*	Transistor source output 0.1A*	Transistor sink output 0.1A*	Transistor source output 0.1A*
Terminal	MIL connector			



1. For specifications see page J-19 & for dimensions see page J-25.
2. For options see J-11 & for accessories see J-12.
3. \*For MIL connector type modules, see page J-12 for cables and breakout modules.





## Combination I/O Modules - 2 Types

Part Number	FC4A-M08BR1	FC4A-M24BR2
Item		
I/O Points	8 (4 in/ 4 out)	24 (16 in/ 8 out)
Output Type	Relay Output, 240V AC/30V DC, 2A	
Input Type	24V DC (Sink/Source)	
Terminal	Removable terminal block	Wire clamp terminal



1. For specifications see page J-21 & for dimensions see page J-25.  
2. For options see J-11 & for accessories see J-12.

## Analog I/O Modules - 4 Types

Part Number	FC4A-K1A1	FC4A-J2A1	FC4A-L03AP1	FC4A-L03A1
Item				
I/O Points	1 Analog Output	2 Analog Inputs	2 Analog Inputs, 1 Analog Output	2 Analog Inputs, 1 Analog Output
Output Type	Voltage (0-10V DC) Current (4-20mA)	–	Voltage (0-10V DC) Current (4-20mA)	Voltage (0-10V DC) Current (4-20mA)
Input Type	–	Voltage (0-10V DC) Current (4-20mA)	Thermocouple Resistance thermometer (RTD)	
Terminal	Removable terminal block			



1. For specifications see page J-22 & for dimensions see page J-25.  
2. For options see J-11 & for accessories see J-12.  
3. New analog modules available Fall '05. See page J-4 for details.

## Expansion Module Examples

Example 1

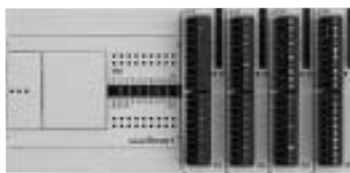

Module	Type No.	Input	Output
CPU	FC4A-C24R2	14	10
DC Input	FC4A-N16B1	16	0
DC Input	FC4A-N16B1	16	0
Relay Output	FC4A-R161	0	16
Relay Output	FC4A-R161	0	16
<b>Total</b>		<b>46</b>	<b>42</b>

Example 2





Module	Type No.	Input	Output
CPU	FC4A-C24R2	14	10
DC Input	FC4A-N08B1	8	0
DC Input/Relay Output	FC4A-M08BR1	4	4
Relay Output	FC4A-R081	0	8
Transistor Sink Output	FC4A-T08K1	0	8
<b>Total</b>		<b>26</b>	<b>30</b>

J

Programmable Logic Controllers

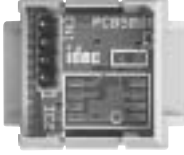
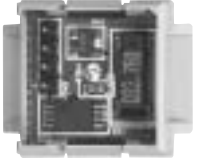

## Optional Modules

Part Number	FC4A-HPH1	FC4A-PH1	FC4A-PM32 FC4A-PM64	FC4A-PT1
Item				
Type	HMI Base Module (does not come with HMI module)	HMI Module	Memory Cartridge	Clock Cartridge
Description	For mounting HMI module with slim type CPU module	For displaying and changing required operands	32KB or 64KB	-



1. For specifications see page J-24.





## Communication Adapters

Part Number	FC4A-PC1	FC4A-PC2	FC4A-PC3
Item			
Type	RS232C	RS485	RS485
Terminal	Mini DIN	Mini DIN	Screw Terminal Type



1. For specifications see page J-24.  
2. Used for All-In-One CPU units only, or for FC4A-HPH1 unit shown above.

## Communication Modules for Slim Type CPUs



Part Number	FC4A-HPC1	FC4A-HPC2	FC4A-HPC3	FC4A-AS62M*
Item				
Type	RS232C	RS485	RS485	AS-Interface Master Module
Terminal	Mini DIN for Slim Type CPU Module	Mini DIN for Slim Type CPU Module	Screw Terminal Type for Slim Type CPU Module	-









1. For specifications see page J-24.  
2. \*FC4A-AS62M is compatible with CPUs: FC4A-D20RK1, FC4A-D20RS1, FC4A-D40K3, and FC4A-D40S3. (See Communication & Networking Section M for more information.)  
3. New web server module available Fall '05. See page J-3 for details.

**Accessories**

**MicroSmart Options**

Item	Description	Length	Part Number
	Programming cable (Loader /user mode selectable)	3m/9.84'	FC4A-KC4CA
	O/I Interface Cable (MicroSmart port 1/2 RS232 to HG1B/2A)	1.5m/5'	FC4A-KC1CA
	O/I Interface Cable (MicroSmart port 1/2 RS232 to HG2F/3F/4F)		FC4A-KC2CA
	Modem Cable	3m/9.84'	FC2A-KM1C
	User Communication Cable	2.4m/7.87'	FC2A-KP1C
	Analog Voltage Input Cables (included with slim type CPU only)	1m/3.28'	FC4A-PMAC2P
	USB/RS232 Converter		FC4A-USB

**MIL Connector Cables (Use with Breakout Modules)**

Item	Length	Part Number	
<b>Non-Shielded</b> 	0.5m	FC9Z-H050B20	
	1m	FC9Z-H100B20	
	2m	FC9Z-H200B20	
	3m	FC9Z-H300B20	
<b>Shielded</b> 	0.5m	FC9Z-H050A20	
	1m	FC9Z-H100A20	
	2m	FC9Z-H200A20	
	3m	FC9Z-H300A20	
<b>Shielded Single Connectors</b> 	16pt & 32pt I/O Modules (20-wire)	5 ft	FC9Z-H100C20A
<b>Non-Shielded</b> 	0.5m	FC9Z-H050B26	
	1m	FC9Z-H100B26	
	2m	FC9Z-H200B26	
	3m	FC9Z-H300B26	
<b>Shielded</b> 	0.5m	FC9Z-H050A26	
	1m	FC9Z-H100A26	
	2m	FC9Z-H200A26	
	3m	FC9Z-H300A26	
<b>Shielded Single Connectors</b> 	20pt & 40pt CPU Modules (26-wire)	5 ft	FC9Z-H100C26A

**Breakout Modules**

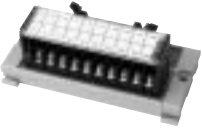
Item	Description	Part Number
	20 points (for 16 & 32 I/O expansion modules)	BX1D-S20A
	26 points (for 20 & 40 I/O CPU modules)	BX1D-S26A

**J**

Programmable Logic Controllers











## Accessories con't

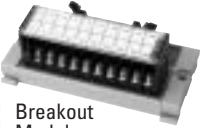











Item	Description	Pkg Qty	Part Number
	13-position terminal blocks for slim type CPU modules (TB1 for FC4A-D20RK1/-D20RS1)	2	FC4A-PMT13P
	16-position terminal blocks for slim type CPU modules (TB2 for FC4A-D20RS1)	2	FC4A-PMTS16P
	16-position terminal blocks for slim type CPU modules (TB2 for FC4A-D20RK1)	2	FC4A-PMTK16P
	11-position terminal blocks for I/O modules (8 point I/O modules)	2	FC4A-PMT11P
	10-position terminal blocks for I/O module (16 point I/O modules)	2	FC4A-PMT10P
	Direct Mounting Strips (for direct mounting of slim type CPU or I/O modules on a panel)	5	FC4A-PSP1P
	End Clips		BNL6
	DIN Rails (1m/3.28' long, 7.5mm height)		BAA1000
	DIN Rails (1m/3.28' long, 10.5mm height)		BNDN1000
	White IDEC screwdriver (2.5mm)		FC9Z-SD2
	Blue IDEC screwdriver (3.5mm)		FC9Z-SD1
	20-position connector socket (MIL connector for I/O modules)	2	FC4A-PMC20P
	26-position connector socket (MIL connector for Slim Type CPU)	2	FC4A-PMC26P
	14-point input simulator switch (Use with FC4A-C24R2 & FC4A-C24R2C)		FC4A-DS824-SW14
	9-point input simulator switch (Use with FC4A-C16R2 & FC4A-C16R2C)		FC4A-DS824-SW9
	6-point input simulator switch (Use with FC4A-C10R2 & FC4A-C10R2C)		FC4A-DS824-SW6
	MicroSmart Users Manual		FC9Y-B812-0A
	Windows-based programming software for IDEC PLCs (for more information, see page J-44).		WINDLDR

**MicroSmart Packages**

**MicroSmart Starter Kits**

Part Number	Includes	
	 Input Simulator Switch  Screwdriver  Breakout Module  15w Power Supply  HMI Display & Base Module  26-Wire I/O Cable	 WindLDR Cables  Manuals
<b>MM-SMART-10</b>	FC4A-C10R2, Input Simulator Switch, Screwdriver	WindLDR, Cables & Manuals
<b>MM-SMART-16</b>	FC4A-C16R2, Input Simulator Switch, Screwdriver	WindLDR, Cables & Manuals
<b>MM-SMART-24</b>	FC4A-C24R2, Input Simulator Switch, Screwdriver	WindLDR, Cables & Manuals
<b>MM-SMART-20</b>	FC4A-D20RK1, HMI Display & Base Module, 15w Power Supply, Screwdriver	WindLDR, Cables & Manuals
<b>MM-SMART-40</b>	FC4A-D40K3, HMI Display & Base Module, 15w Power Supply, 26-Wire I/O Cable & Breakout Module, Screwdriver	WindLDR, Cables & Manuals

**MicroSmart Solution Packages**

	Part Number	Micro Smart CPU	Operator Interface	Power Supply	Accessories	
				 15W  50W	 WindLDR  Cables  WindMSG  Manuals  WindO/I-NV2	
	<b>MM-SMART-10-252</b>	10 I/O	HG1X 2 line	—	WindLDR, WindMSG, Cables & Manuals	—
	<b>MM-SMART-16-452</b>	16 I/O	HG1X 4 line	—	WindLDR, WindMSG, Cables & Manuals	—
	<b>MM-SMART-10-HG1B</b>	10 I/O	HG1B RS232/485	15W	WindLDR, WindO/I-NV2, Cables & Manuals	E-Stop & Nameplate
	<b>MM-SMART-16-HG1B</b>	16 I/O	HG1B RS232/485	15W	WindLDR, WindO/I-NV2, Cables & Manuals	E-Stop & Nameplate
	<b>MM-SMART-24-HG1B</b>	24 I/O	HG1B RS232/485	15W	WindLDR, WindO/I-NV2, Cables & Manuals	E-Stop & Nameplate
	<b>MM-SMART-20-HG1B</b>	20 I/O	HG1B RS232/485	50W	WindLDR, WindO/I-NV2, Cables & Manuals	E-Stop & Nameplate
	<b>MM-SMART-40-HG1B</b>	40 I/O	HG1B RS232/485	50W	WindLDR, WindO/I-NV2, Cables & Manuals	E-Stop & Nameplate
	<b>MM-SMART-16-HG2F-M</b>	16 I/O	HG2F Monochrome	15W	WindLDR, WindO/I-NV2, Cables & Manuals	E-Stop & Nameplate
	<b>MM-SMART-16-HG2F-C</b>	16 I/O	HG2F Color	15W	WindLDR, WindO/I-NV2, Cables & Manuals	E-Stop & Nameplate
	<b>MM-SMART-24-HG2F-M</b>	24 I/O	HG2F Monochrome	15W	WindLDR, WindO/I-NV2, Cables & Manuals	E-Stop & Nameplate
	<b>MM-SMART-24-HG2F-C</b>	24 I/O	HG2F Color	15W	WindLDR, WindO/I-NV2, Cables & Manuals	E-Stop & Nameplate
	<b>MM-SMART-20-HG2F-M</b>	20 I/O	HG2F Monochrome	50W	WindLDR, WindO/I-NV2, Cables & Manuals	E-Stop & Nameplate
	<b>MM-SMART-20-HG2F-C</b>	20 I/O	HG2F Color	50W	WindLDR, WindO/I-NV2, Cables & Manuals	E-Stop & Nameplate
	<b>MM-SMART-40-HG2F-M</b>	40 I/O	HG2F Monochrome	50W	WindLDR, WindO/I-NV2, Cables & Manuals	E-Stop & Nameplate
	<b>MM-SMART-40-HG2F-C</b>	40 I/O	HG2F Color	50W	WindLDR, WindO/I-NV2, Cables & Manuals	E-Stop & Nameplate
	<b>MM-SMART-24-HG3F</b>	24 I/O	HG3F 10.4" TFT Color	60W	WindLDR, WindO/I-NV2, Cables & Manuals	E-Stop & Nameplate
	<b>MM-SMART-24-HG4F</b>	24 I/O	HG4F 12.1" TFT Color	60W	WindLDR, WindO/I-NV2, Cables & Manuals	E-Stop & Nameplate

Programmable Logic Controllers **J**

## General Specifications (CPU Module)

		FC4A-C10R2 FC4A-C10R2C	FC4A-C16R2 FC4A-C16R2C	FC4A-C24R2 FC4A-C24R2C	FC4A-D20K3 FC4A-D20S3	FC4A-D20RK1 FC4A-D20RS1	FC4A-D40K3 FC4A-D40S3	
CPU General Specifications	<b>Rated Voltage</b>	AC Power Type: 100-240V AC DC Power Type: 24V DC			24V DC			
	<b>Allowable Range</b>	AC Power Type: 85-264V AC DC Power Type: 16.0 - 31.2V DC			20.4 to 26.4V DC (including ripple)			
	<b>Rated Frequency</b>	AC Power Type: 50/60 Hz (47-63 Hz)			—			
	<b>Maximum Input Current</b>	0.25A (85V AC or 24V DC)	0.30A (85V AC or 24V DC)	0.45A (85V AC or 24V DC) **	0.56A (26.4V DC) #	0.70A (26.4V DC) #		
	<b>Max. Power Consumption</b>	AC	30VA/264V AC * 20VA/100V AC	31VA/264V AC * 22VA/100V AC	40VA/264V AC ** 33VA/100V AC	15W/26.4V DC #	19W/26.4V DC #	
		DC	3.8W/24V DC	4.6W/24V DC	8.7W/24V DC	Not applicable		
	<b>Allowable Momentary Power Interruption</b>	10 msec at the rated inputs and outputs (IEC61131)			10 msec (at 24V DC)			
	<b>Dielectric Strength</b>	Between power and ⊕ terminal: 1500V AC, 1 min Between I/O and ⊕ terminal: 1500V AC, 1 min			Between power and ⊕ terminal: 500V AC, 1 min Between I/O and ⊕ terminal: 1500V AC, 1 min			
	<b>Insulation Resistance</b>	Between power and ⊕ terminal: 10 MΩ (min), 500V DC Between I/O and ⊕ terminal: 10 MΩ (min), 500V DC			Between power and ⊕ terminal: 10 MΩ (min) Between I/O and ⊕ terminal: 10 MΩ (min)			
	<b>Noise Resistance</b>	AC or DC power terminal: 1.5 kV, 50ns to 1μs I/O terminal (coupling clamp): 1.5 kV, 50ns to 1μs			DC power terminals: 1.0 kV, 50 nsec to 1μsec I/O terminals (coupling clamp): 1.5 kV, 50 nsec to 1μsec			
	<b>Inrush Current</b>	35A max.	35A max.	40A max.	50A maximum (24V DC)			
	<b>Power Supply Wire</b>	22 - 18AWG						
	<b>Operating Temperature</b>	0 to 55°C						
	<b>Storage Temperature</b>	-25 to +70°C						
	<b>Operating Humidity</b>	30-95% Level RH1 (no condensation)						
	<b>Altitude</b>	Operation: 0 to 2,000m (0 to 6,595 ft) Transport: 0 to 3,000m (0 to 9,840 ft)						
	<b>Pollution Degree</b>	2 (IEC60664)						
	<b>Corrosion Immunity</b>	Free from corrosive gases						
	<b>Degree of Protection</b>	IP20						
<b>Grounding Wire</b>	16 AWG			22 AWG				
<b>Vibration Resistance</b>	DIN rail mounted: 10 to 57Hz / amplitude 0.075mm, 57 to 150Hz / acceleration 9.8m/s <sup>2</sup> (1G) Direct mounted: 2 to 25Hz / amplitude 1.6mm, 25 to 100Hz / acceleration 39.2m/s <sup>2</sup> (4B) in each of 3 axes							
<b>Shock Resistance</b>	15G, 11ms, 3 shocks in each of 3 axes							
<b>Weight</b>	AC	230g	250g	305g	Not Applicable			
	DC	240g	260g	310g	140g	185g	180g	



- \* CPU module power consumption includes 250 mA sensor power.
- \*\* CPU module (including 250 mA sensor power) + 4 I/O modules
- # CPU module + 7 I/O modules

### Communication Port 1 Specifications

<b>Standards</b>	EIA RS232C
<b>Maximum Baud Rate</b>	19200 bps
<b>Maintenance Communication</b>	Possible
<b>User Communication</b>	Possible
<b>Modem Communication</b>	Not possible
<b>Data Link Communication</b>	Not possible
<b>Cable</b>	Special Cables: FC2A-KC4C, FC2A-KP1C, FC4A-KC1CA, FC4A-KC2CA
<b>Isolation between Internal Circuit and Communication Port</b>	Not isolated

## Function Specifications (CPU Module)

	FC4A-C10R2 FC4A-C10R2C	FC4A-C16R2 FC4A-C16R2C	FC4A-C24R2 FC4A-C24R2C	FC4A-D20K3 FC4A-D20S3	FC4A-D20RK1 FC4A-D20RS1	FC4A-D40K3 FC4A-D40S3
<b>Control System</b>	Stored program system					
<b>Instruction words</b>	35 basic instructions					
	38 advanced	40 advanced	46 advanced	53 advanced	70 advanced	
<b>Program Capacity</b>	4,800 bytes (800 steps)	15,000 bytes (2,500 steps)	27,000 bytes (4,500 steps)	27,000 bytes (4,500 steps)	31,200 bytes (5,200 steps)	
	Calculated 6 bytes per step					
<b>User Program Storage</b>	Internal EEPROM, Memory cartridge (option: EEPROM)					
<b>Processing Time</b>	Basic instruction: 1.65 msec (1000 steps); END processing: 0.64 msec (does not include expansion I/O service, clock function processing, data link processing and interrupt processing)					
<b>Expandable I/O Modules</b>	—	—	4 modules	7 modules		
<b>RAM Backup</b>	Backup Data: Internal relay, shift register, counter, data register Backup Duration: Approx. 30 days (typical) at 25° C after backup battery fully charged Battery: Lithium secondary battery Charging Time: Approx. 15 hours for charging from 0% to 90% of full charge Battery Life: 5 years Replaceability: Impossible to replace battery					
<b>I/O Points</b>	6 input, 4 output	9 input, 7 output	14 input, 10 output Expansion: 64 I/O	12 input, 8 output Expansion: 128 I/O	12 input, 8 output Expansion: 224 I/O	24 input, 16 output Expansion: 224 I/O
<b>Internal Relay</b>	256	1024				
<b>Shift Register</b>	64	128				
<b>Data Register</b>	400	1300				
<b>Expansion Data Register</b>	—				6000	
<b>Counter</b>	32	100				
<b>Timer (1-sec, 100-msec, 10-msec, 1-msec)</b>	32	100				
<b>Self-Diagnostic Function</b>	Power failure check, watchdog timer, data link connection, user program EEPROM sum check, timer/counter preset value sum check, user program RAM sum check, keep data, user program syntax, user program writing, CPU module, clock IC, I/O bus initialize, user program execution					
<b>Input Filter</b>	3 to 15 msec (1-msec increments)					
<b>Catch Input/Interrupt Input</b>	4 input (I2 through I5) Minimum turn on pulse width: 40 µsec maximum Minimum turn off pulse width: 150 µsec maximum					
<b>High-Speed Counter</b>	Total 4 points: Single/two-phase selectable: 20kHz (1 point) Single-phase: 5kHz (3 points)			Total 4 points: Single/two-phase selectable: 20kHz (2 points) Single-phase: 5kHz (2 points)		
	Counting Range 0 to 65535 (16 bits), Operation Mode: Rotary encoder mode and adding counter mode					
<b>Analog Potentiometer</b>	1 point	2 points	1 point			
	Data Range: 0 to 255					
<b>Analog Voltage Input</b>	—			1 point, 0 to 10V DC Input Voltage Range, approx. 100kΩ Input Impedance, data range 0-255 (8 bit)		
<b>Pulse Output</b>	—			2 points, max. frequency 20kHz		
<b>Sensor Power Supply</b>	24V DC (+10% to -15%), 250 mA, no overload detection Isolated from the internal circuit			—		
<b>Port 1</b>	RS232C Maintenance Communication, User Communication, Modem Communication					
<b>Port 2 (optional)</b>	—	Possible: RS232C or RS485 (Maintenance communication, data link)				
<b>Clock Function (optional)</b>	Possible			Possible Year, month, day, day of week, hour, minute, second		
<b>Memory Cartridge (optional)</b>	Select either clock or memory cartridge			Possible		
<b>HMI Module (optional)</b>	Possible			Possible using HMI Base Module		

Programmable Logic Controllers CPU Function Specifications

## DC Input/Relay Output Specifications (CPU Module)

### DC Input Specifications for CPU modules

		FC4A-C10R2 FC4A-C10R2C	FC4A-C16R2 FC4A-C16R2C	FC4A-C24R2 FC4A-C24R2C	FC4A-D20K3 FC4A-D20S3	FC4A-D20RK1 FC4A-D20RS1	FC4A-D40K3 FC4A-D40S3
<b>Rated Input Voltage</b>		24V DC sink / source input signal					
<b>Allowable Range</b>		20.4 to 28.8V DC			20.4 to 26.4V DC		
<b>Rated Input Current</b>		I0, I1: 11mA, I2 to I7, I10 to I15: 7mA			I0, I1, I6, I7: 5mA/point, I2 to I5, I10 to I27: 7mA/point		
<b>Input Impedance</b>		I0, I1: 2.1kΩ, I2 to I7, I10 to I15: 3.4kΩ			I0, I1, I6, I7: 5.7kΩ, I2 to I5, I10 to I27: 3.4kΩ		
<b>OFF/ON Time</b>	<b>OFF/ON</b>	I0 to I5: 35μsec + Filter Value I6, I7, I10 to I15: 40μsec + Filter Value			I0 to I7: 35μsec + Filter Value I10 to I27: 40μsec + Filter Value		
	<b>ON/OFF</b>	I0, I1: 45μsec + Filter Value I2 to I7, I10 to I15: 150μsec + Filter Value			I0, I1, I6, I7: 45μsec + Filter Value I2 to I5, I10 to I27: 150μsec + Filter Value		
<b>Input Points</b>		6 inputs 6/1 common	9 inputs 9/1 common	14 inputs 14/1 common	12 inputs 12/1 common	12 inputs 12/1 common	24 inputs, 12/1 common
<b>Connector</b>	<b>On Mother Board</b>	—			FL26A2MA (Oki Electric Cable)	MC1.5/13-G-3.81BK (Phoenix Contact)	FL26A2MA (Oki Electric Cable)
	<b>Insertion/Removal Durability</b>	—			100 times minimum		
<b>Isolation</b>		Between input terminals: Not isolated Internal circuit: Photocoupler isolated					
<b>Input Type</b>		Type 1 (IEC61131)					
<b>External Load for I/O Interconnection</b>		Not needed					
<b>Signal Determination Method</b>		Static					
<b>Effect of Improper Input Connection</b>		Both sinking and sourcing input signals can be connected. If any input exceeding the rated value is applied, permanent damage may be caused.					
<b>Cable Length</b>		3m (9.84 ft)					

### Relay Output Specifications for CPU modules

		FC4A-C10R2 FC4A-C10R2C	FC4A-C16R2 FC4A-C16R2C	FC4A-C24R2 FC4A-C24R2C	FC4A-D20RK1 FC4A-D20RS1
<b>Output Points</b>		4 points	7 points	10 points	8 points
<b>Output Points per Common</b>	<b>COM0</b>	3 points	4 points	4 points	2 points (transistor output)
	<b>COM1</b>	1 point	2 points	4 points	3 points
	<b>COM2</b>	—	1 point	1 point	2 points
	<b>COM3</b>	—	—	1 point	1 point
<b>Type of Output</b>		1NO			
<b>Maximum Load Current</b>	<b>Per point</b>	2A			
	<b>Per Common</b>	8A			
<b>Minimum Switching Load</b>		0.1mA, 0.1V DC (reference value)			
<b>Initial Contact Resistance</b>		30mΩ maximum			
<b>Electrical Life</b>		100,000 operations (rated load) @ 1,800 operations/hr			
<b>Mechanical Life</b>		200,000 operations (no load) @ 18,000 operations/hr			
<b>Rated Load Current (resistive/inductive)</b>		240V AC/2A, 24V DC/2A (30V DC / 2A)			
<b>Dielectric Strength</b>		Between output and ⊕ terminals: 1500V AC, 1 minute Between output terminals and internal circuit: 1500V AC, 1 minute Between output terminals (COMs): 1500 V AC, 1 minute			
<b>Connector</b>	<b>On Mother Board</b>	—			MC1.5/16-G-3.81BK (Phoenix Contact)
	<b>Insertion/Removal Durability</b>	—			100 times minimum

**Transistor Sink and Source Output Specifications (CPU Module)**

**Transistor Sink and Source Output Specifications for CPU modules**

		<b>FC4A-D20K3 FC4A-D20S3</b>	<b>FC4A-D20RK1 FC4A-D20RS1</b>	<b>FC4A-D40K3 FC4A-D40S3</b>
<b>Output Points and Common Line</b>		8 points, 8/1 common	2 points, 2/1 common	16 points, 8/1 common
<b>Type of Output</b>		FC4A-D20K3/D20RK1/D40K3 = Sink Output FC4A-D20S3/D20RS1/D40S3 = Source Output		
<b>Rated Load Voltage</b>		24V DC		
<b>Operating Load Voltage Range</b>		20.4 to 28.8V DC		
<b>Rated Load Current</b>		0.3A per output point		
<b>Maximum Load Current</b>		1A per common line		
<b>Voltage Drop (ON Voltage)</b>		1V maximum (voltage between COM and output terminals when output is on)		
<b>Inrush Current</b>		1A maximum		
<b>Leakage Current</b>		0.1 mA maximum		
<b>Clamping Voltage</b>		39V±1V		
<b>Maximum Lamp Load</b>		8W		
<b>Inductive Load</b>		L/R = 10ms (28.8V DC, 1Hz)		
<b>External Current Draw</b>		100mA maximum, 24V DC (power voltage at the +V or -V terminal)		
<b>Isolation</b>		Between output terminal and internal circuit: Photocoupler isolated Between output terminals: Not isolated		
<b>Connector</b>	<b>On Mother Board</b>	FL26A2MA (Oki Electric Cable)	MC1.5/16-G-3.81BK (Phoenix Contact)	FL26A2MA (Oki Electric Cable)
	<b>Insertion/Removal Durability</b>	100 times minimum		
<b>Output Delay</b>	<b>Turn ON time</b>	5 μs (Q0, Q1), 300 μs max (Q2 to Q7, Q10 to Q17)		
	<b>Turn OFF time</b>	5 μs (Q0, Q1), 300 μs max (Q2 to Q7, Q10 to Q17)		

**J**

**Programmable Logic Controllers**

## Input/Relay Output Specifications (Expansion Modules)

### Input Module Specifications

		DC Input				AC Input
		FC4A-N08B1	FC4A-N16B1	FC4A-N16B3	FC4A-N32B3	FC4A-N08A11
<b>Input Points</b>		8 points (8/1 common)	16 points (16/1 common)		32 points (16/1 common)	8 points (4/1 common)
<b>Rated Input Voltage</b>		24V DC sink/source input signal				100 - 120V AC (50-60Hz)
<b>Input Voltage Range</b>		20.4 to 28.8V DC				85 to 132V AC
<b>Rated Input Current</b>		7mA/point (24V DC)		5mA/point (24V DC)		7.5mA/pt (100V AC, 60Hz)
<b>Input Impedance</b>		3.4 kΩ		4.4 kΩ		0.8kΩ (60Hz)
<b>Input Delay Time</b>		ON time: 4 msec OFF time: 4 msec				ON time: 25 msec OFF time: 30 msec
<b>Isolation</b>	Between input terminals	Not isolated				In the same commons: not isolated In different commons: 500V
	Internal circuit	Photocoupler isolated				2500V (photocoupler isolated)
<b>External Load for I/O Interconnection</b>		Not needed				
<b>Signal Determination Method</b>		Static				
<b>Effect of Improper Input Connection</b>		Both sinking and sourcing input signals can be connected. If any input exceeding the rated value is applied, permanent damage may be caused.				
<b>Cable Length</b>		3m (9.84 ft) in compliance with electromagnetic immunity				
<b>Connector</b>	<b>On Mother Board</b>	MC1.5/10-G-3.81BK (Phoenix contact)		FL20A2MA (Oki Electric Cable)		
	<b>Insertion/Removal Durability</b>	100 times minimum				
<b>Internal Current Draw</b>	<b>All Inputs ON</b>	25 mA (5V DC) 0 mA (24V DC)	40 mA (5V DC) 0 mA (24V DC)	35 mA (5V DC) 0 mA (24V DC)	65 mA (5V DC) 0 mA (24V DC)	60mA (5V DC) 0mA (24V DC)
	<b>All Inputs OFF</b>	5 mA (5V DC) 0 mA (24V DC)	5 mA (5V DC) 0 mA (24V DC)	5 mA (5V DC) 0 mA (24V DC)	10 mA (5V DC) 0 mA (24V DC)	30mA (5V DC) 0mA (24V DC)
<b>Weight</b>		85g	100g	65g	100g	-

### Relay Output Module Specifications

		FC4A-R081	FC4A-R161
<b>Output Points and Common Lines</b>		8 points (4/1 common)	16 points (8/1 common)
<b>Output Type</b>		1NO	
<b>Maximum Load Current</b>	<b>per point</b>	2A	
	<b>per common</b>	7A	8A
<b>Minimum Switching Load</b>		0.1 mA/0.1V DC (reference value)	
<b>Initial Contact Resistance</b>		30 mΩ maximum	
<b>Electrical Life</b>		100,000 operations minimum (rated load 1,800 operations/hour)	
<b>Mechanical Life</b>		20,000,000 operations minimum (no load 18,000 operations/hour)	
<b>Rated Load (resistive/inductive)</b>		240V AC/2A, 30V DC/2A	
<b>Dielectric Strength</b>		Between output and ⊕ terminals: 1500V AC, 1 minute Between output terminals and internal circuit: 1500V AC, 1 minute Between output terminals (COMs): 1500 V AC, 1 minute	
<b>Connector</b>	<b>On Mother Board</b>	MC1.5/11-G-3.81BK (Phoenix contact)	MC1.5/10-G-3.81BK (Phoenix contact)
	<b>Insertion/Removal Durability</b>	100 times minimum	
<b>Internal Current Draw</b>	<b>All Inputs ON</b>	30 mA (5V DC) 40 mA (24V DC)	45 mA (5V DC) 75 mA (24V DC)
	<b>All Inputs OFF</b>	5 mA (5V DC) 0 mA (24V DC)	5 mA (5V DC) 0 mA (24V DC)
<b>Weight</b>		110g	145g

**Transistor Output Specifications (Expansion Modules)**
**Transistor Output Module Specifications**

		FC4A-T08K1 FC4A-T08S1	FC4A-T16K3 FC4A-T16S3	FC4A-T32K3 FC4A-T32S3
<b>Output Points</b>		8 points (8/1 common)	16 points (16/1 common)	32 points (16/1 common)
<b>Output Type</b>		FC4A-T□K□: Transistor sink output FC4A-T□S□: Transistor source output		
<b>Rated Load Voltage</b>		24V DC		
<b>Operating Load Voltage Range</b>		20.4 to 28.8V DC		
<b>Rated Load Current</b>		0.3A per output point (at 28.8V DC)	0.1A per output point (at 28.8V DC)	
<b>Maximum Load Current</b>	<b>per point</b>	0.36A (at 28.8V DC)	0.12A (at 28.8V DC)	
	<b>per common</b>	3A (at 28.8V DC)	1A (at 28.8V DC)	
<b>Voltage Drop (ON Voltage)</b>		1V maximum (between COM and output terminals when output is on)		
<b>Inrush Current</b>		1A maximum		
<b>Leakage Current</b>		0.1A maximum		
<b>Clamping Voltage</b>		39V ± 1V		
<b>Maximum Clamping Load</b>		8W		
<b>Inductive Load</b>		L/R = 10 msec (DC 28.8V, 1Hz)		
<b>External Current Draw</b>		FC4A-T□K□: 100mA maximum, 24V DC (power voltage at the +V) FC4A-T□S□: 100mA maximum, 24V DC (power voltage at the -V)		
<b>Isolation</b>		Between output terminal and internal circuit: Photocoupler isolated Between output terminals: Not isolated		
<b>Connector</b>	<b>Type (on Mother Board)</b>	MC1.5/10-G-3.81BK (Phoenix contact)	FL20A2MA (Oki Electric Cable)	
	<b>Insertion/Removal Durability</b>	100 times minimum		
<b>Internal Current Draw</b>	<b>All Inputs ON</b>	10mA (5V DC) 20mA (24V DC)	10mA (5V DC) 40mA (24V DC)	20mA (5V DC) 70mA (24V DC)
	<b>All Inputs OFF</b>	5mA (5V DC) 0mA (24V DC)	5mA (5V DC) 0mA (24V DC)	10mA (5V DC) 0mA (24V DC)
<b>Output Delay</b>	<b>Turn ON time</b>	300µsec maximum		
	<b>Turn OFF time</b>	300µsec maximum		
<b>Weight</b>		85g	70g	105g

J

Programmable Logic Controllers



## Combination I/O Specifications (Expansion Modules)

### Combination I/O Module Specifications

		FC4A-M08BR1	FC4A-M24BR2	
<b>DC Input Specifications</b>	<b>Input Points</b>	4 points (4/1 common)	16 points (16/1 common)	
	<b>Rated Input Voltage</b>	24V DC sink/source input signal		
	<b>Input Voltage Range</b>	20.4 to 28.8V DC		
	<b>Range Input Current</b>	7 mA/point (24V DC)		
	<b>Input Impedance</b>	3.4 kΩ		
	<b>Turn ON Time</b>	4 msec (24V DC)		
	<b>Turn OFF Time</b>	4 msec (24V DC)		
	<b>Isolation</b>	Between input terminals: Not isolated Internal circuit: Photocoupler isolated		
	<b>External Load for I/O Interconnection</b>	Not needed		
	<b>Signal Determination Method</b>	Static		
	<b>Effect of Improper Input Connection</b>	Both sinking and sourcing input signals can be connected. If any input exceeding the rated value is applied, permanent damage may be caused.		
	<b>Cable Length</b>	3m (9.84 ft) in compliance with electromagnetic immunity		
<b>Relay Output Specifications</b>	<b>Output Points</b>	4 points (4/1 common)	8 points (8/2 common)	
	<b>Output Type</b>	1NO		
	<b>Maximum Load Current</b>	per point	2A	
		per common	7A	
	<b>Minimum Switching Load</b>	0.1 mA/0.1V DC (reference value)		
	<b>Initial Contact Resistance</b>	30 mΩ maximum		
	<b>Electrical Life</b>	100,000 operations minimum (rated load 1,800 operations/hour)		
	<b>Mechanical Life</b>	20,000,000 operations minimum (no load 18,000 operations/hour)		
	<b>Rated Load (resistive/inductive)</b>	240V AC/2A, 30V DC/2A		
	<b>Dielectric Strength</b>	Between output and ⊕ or ⊖ terminals: 1,500V AC, 1 minute Between output terminal and internal circuit: 1,500V AC, 1 minute Between output terminal (COMs): 1,500V AC, 1 minute		
<b>Connector</b>	<b>on Mother Board</b>	MC1.5/11-G-3.81BK (Phoenix contact)	Input: F6018-17P (Fujicon) Output: F6018-11P (Fujicon)	
	<b>Insertion/Removal Durability</b>	100 times minimum	—	
	<b>Internal Current Draw</b>	<b>All Inputs ON</b>	25 mA (5V DC) 20 mA (24V DC)	65 mA (5V DC) 45 mA (24V DC)
		<b>All Inputs OFF</b>	5 mA (5V DC) 0 mA (24V DC)	10 mA (5V DC) 0 mA (24V DC)
<b>Weight</b>	95g		140g	

**Analog I/O Specifications (Expansion Modules)**

**Analog I/O Module Specifications**

	<b>FC4A-L03A1</b>	<b>FC4A-L03AP1</b>	<b>FC4A-J2A1</b>	<b>FC4A-K1A1</b>
<b>Input Points</b>	2	2	2	—
<b>Input Signal Type</b>	Voltage Input (0 to 10V DC) Current Input (4 to 20 mA DC)	Thermocouple Resistance Thermometer	Voltage Input (0 to 10V DC) Current Input (4 to 20 mA DC)	—
<b>Output Points</b>	1	1	—	1
<b>Output Signal Type</b>	Voltage Output (0 to 10V DC) Current Output (4 to 20 mA DC)	Voltage Output (0 to 10V DC) Current Output (4 to 20 mA DC)	—	Voltage Output (0 to 10V DC) Current Output (4 to 20 mA DC)
<b>Rated Power Voltage</b>	24V DC			
<b>Allowable Voltage Range</b>	20.4 to 28.8V DC			
<b>Connector</b>	<b>On Mother Board</b>			
	MC1.5/11-G-3.81BK (Phoenix contact)			
<b>Internal Current Draw</b>	<b>Insertion/Removal Durability</b>			
	100 times minimum			
<b>Internal Current Draw</b>	<b>Internal Power</b>	50 mA (5V DC) 0 mA (24V DC)	50 mA (5V DC) 0 mA (24V DC)	50 mA (5V DC) 0 mA (24V DC)
	<b>External Power</b>	40 mA (24V DC)	40 mA (24V DC)	40 mA (24V DC)
<b>Weight</b>	85g			

**Analog Output Specifications**

		<b>FC4A-L03A1, FC4A-L03AP1, FC4A-K1A1</b>	
		<b>Voltage Output</b>	<b>Current Output</b>
<b>Output Signal Type</b>		0 to 10V DC	4 to 20 mA DC
<b>Output Range</b>		2 kΩ minimum	300Ω maximum
<b>Load Impedance</b>		Resistive load	
<b>Applicable Load Type</b>		20 msec	
<b>Setting Time</b>		20 msec + 1 scan time	
<b>Total Output System Transfer Time</b>		±0.2% of full scale	
<b>Output Error</b>	<b>Maximum Error at 25°C</b>	±0.015% of full scale/°C	
	<b>Temperature Coefficient</b>	±0.5% of full scale	
	<b>Repeatability after Stabilization Time</b>	±1% of full scale	—
	<b>Output Voltage Drop</b>	±0.2% of full scale	
	<b>Non-linearity</b>	1 LSB maximum	
	<b>Output Ripple</b>	0%	
	<b>Overshoot</b>	±1% of full scale	
	<b>Total Error</b>	4096 increments (12 bits)	
<b>Data</b>	<b>Digital Resolution</b>	2.5 mV	4 μA
	<b>Output Value of LSB</b>	0 to 4095 (12-bit data); -32768 to 32767 (optional range designation) See note on page J-23	
	<b>Data Type in Application Program</b>	Yes	
	<b>Monotonicity</b>	—	Detectable (See note on page J-23)
<b>Noise</b>	<b>Current Loop Open</b>	±3% max. when a 500V clamp is applied to the power and I/O wiring	
	<b>Maximum Temporary Deviation during Electrical Noise Tests</b>	Twisted pair shielded cable recommended for improved noise immunity	
	<b>Cable</b>	No crosstalk because of 1 channel output	
	<b>Crosstalk</b>	500V between output and power circuit	
<b>Dielectric Strength</b>		Photocoupler between output and internal circuit	
<b>Type of Protection</b>		No damage	
<b>Effect of Improper Output Connection</b>		Using software programming	
<b>Selection of Analog Output Signal Type</b>		Impossible (approx. 10 years)	
<b>Calibration or Verification to Maintain Rated Accuracy</b>			

**J** Programmable Logic Controllers

## Analog Input Specifications (Expansion Modules)

### Analog Input Specifications

		FC4A-L03A1, FC4A-J2A1		FC4A-L03AP1		
Input Signal Type		Voltage Input	Current Input	Thermocouple	Resistance Thermometer	
Input Range		0 to 10V DC	4 to 20 mA DC	Type K (0 to 1300°C) Type J (0 to 1200°C) Type T (0 to 400°C)	Pt 100 3-wire type (-100 to 500°C)	
Input Impedance		1 MΩ minimum	10Ω	1 MΩ minimum	1 MΩ minimum	
Allowable Conductor Resistance		—	—	—	200Ω maximum	
Input Detection Current		—	—	—	1.0 mA maximum	
Sample Duration Time		16 msec maximum		50 msec maximum		
Sample Repetition Time		16 msec maximum		50 msec maximum		
Total Input System Transfer Time		32 msec + 1 scan time *		100 msec + 1 scan time *		
Type of Input		Single-ended input	Differential input			
Operating Mode		Self scan				
Conversion Method		ΣΔ type ADC				
Input Error	Maximum Error at 25°C	±0.2% of full scale		±0.2% of full scale plus reference junction compensa- tion accuracy (±4°C maximum)	±0.2% of full scale	
	Temperature Coefficient	±0.006% of full scale / °C				
	Repeatability after Stabilization Time	±0.5% of full scale				
	Non-linearity	±0.2% of full scale				
	Maximum Error	±1% of full scale				
Data	Digital Resolution	4096 increments (12 bits)				
	Input Value of LSB	2.5 mV	4 μA	K: 0.325°C; J: 0.300°C; T: 0.100°C	0.15°C	
	Data Type in Application Program	0 to 4095 (12-bit data); -32768 to 32767 (optional range designation) **				
	Monotonicity	Yes				
	Input Data Out of Range	Detectable #				
Noise Resistance	Maximum Temporary Deviation during Electrical Noise Tests	±3% maximum when a 500V clamp voltage is applied to the power and I/O wiring			Accuracy is not assured when noise is applied	
	Common Mode Characteristics	Common mode reject ratio (CMRR): -50 dB				
	Common Mode Voltage	16V DC				
	Input Filter	No				
	Cable	Twisted pair shielded cable recommended for improved noise immunity		—		
	Crosstalk	2 LSB maximum				
Dielectric Strength		500V between input and power circuit				
Type of Protection		Photocoupler between input and internal circuit				
Effect of Improper Input Connection		No damage				
Maximum Permanent Allowed Overload (No damage)		13V DC	40 mA DC	—		
Selection of Analog Input Signal Type		Using software programming				
Calibration or Verification to Maintain Rated Accuracy		Impossible (approx. 10 years)				

J

Programmable Logic Controllers



#### NOTES FOR ANALOG EXPANSION UNITS:

- \* Total input system transfer time = Sample repetition time x 2 + 1 scan time
- \*\* The 12-bit data (0 to 4095) processed in the analog I/O module can be linear-converted to a value between -32768 and 32767. Select the optional range designations and analog I/O data minimum and maximum values by using data registers allocated to analog I/O modules.
- # When an error is detected, a corresponding error code is sorted to a data register allocated to analog I/O operating status.

## Communication Adapter and Communication Module Specifications (Expansion Modules)

### Communication Adapter and Communication Module Specifications

	FC4A-PC1 FC4A-HPC1	FC4A-PC2 FC4A-HPC2	FC4A-PC3 FC4A-HPC3
<b>Standards</b>	EIA RS232C	EIA RS485	EIA RS485
<b>Maximum Baud Rate</b>	19200 bps	19200 bps	Computer link: 19200 bps Data link: 38400 bps
<b>Maintenance Communication</b>	Possible	Possible	Possible
<b>User Communication</b>	Possible	Impossible	Impossible
<b>Modem Communication</b>	Possible	Impossible	Impossible
<b>Data Link Communication</b>	Impossible	Impossible	Possible
<b>Maximum Cable Length</b>	special cable	special cable	200m
<b>Quantity of Slave Stations</b>	—	—	31
<b>Isolation between Internal Circuit and Communication Port</b>	Not isolated		
<b>Recommended Cable for RS485</b>	—	—	Twisted-pair shielded cable with a minimum core wire of 0.3 mm <sup>2</sup>
<b>Conductor Resistance</b>	—	—	85 Ω/km maximum
<b>Shield Resistance</b>	—	—	20 Ω/km maximum

### Option Specifications

#### Optional HMI Module Specifications

	FC4A-PH1
<b>Power Voltage</b>	5V DC (supplied from the CPU module)
<b>Internal Current Draw</b>	200mA DC
<b>Weight</b>	20g

#### Optional Memory Cartridge Specifications

	FC4A-PM32	FC4A-PM64
<b>Memory Type</b>	EEPROM	
<b>Accessible Memory Capacity</b>	32 KB	64 KB
<b>Hardware for Storing Data</b>	CPU module	
<b>Software for Storing Data</b>	WindLDR	
<b>Quantity of Store Programs</b>	One user program can be stored on one memory cartridge	

#### Optional Clock Cartridge Specifications

	FC4A-PT1
<b>Accuracy</b>	±30 sec/month (typical) at 25°C
<b>Backup Duration</b>	Approx. 30 days (typical) at 25°C after backup battery fully charged
<b>Battery</b>	Lithium secondary battery
<b>Charging Time</b>	Approx. 10 hours for charging from 0% to 90% of full charge
<b>Replaceability</b>	Impossible to replace battery

## Dimensions

### CPU Modules:

all dimensions in mm

FC4A-C10R2, FC4A-C16R2  
FC4A-C10R2C, FC4A-C16R2C

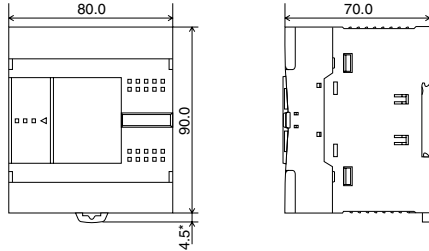

FC4A-C24R2, FC4A-C24R2C

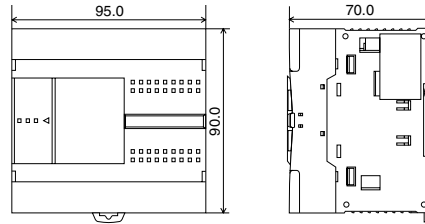

FC4A-D20K3, FC4A-D20S3

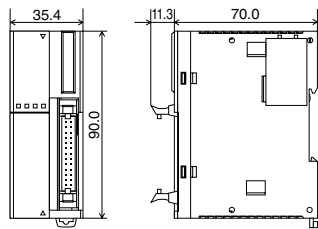

FC4A-D20RK1, FC4A-D20RS1

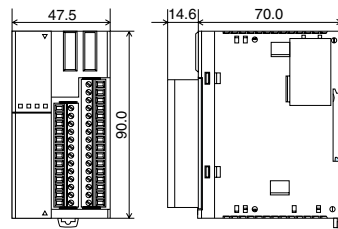

FC4A-D40K3, FC4A-D40S3

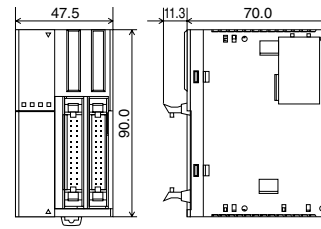

### Expansion Modules:

FC4A-N08B1, FC4A-N08A11, FCA-T08K1,  
FC4A-M08BR1, FC4A-L03AP1, FC4A-K1A1  
FC4A-R081, FC4A-T08S1, FC4A-L03A1,  
FC4A-J2A1

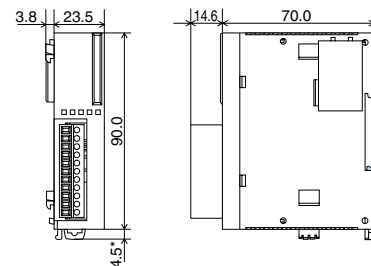

FC4A-N16B3, FC4A-T16K3, FC4A-T16S3

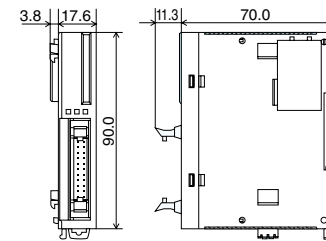

FC4A-HPC1, FC4A-HPC2, FC4A-HPC3

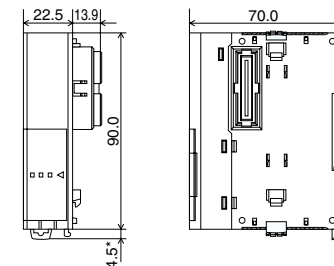

FC4A-N16B1, FC4A-R161

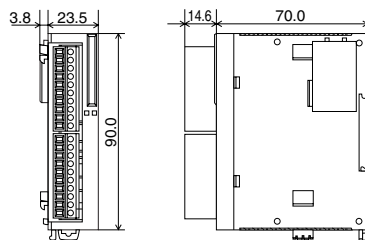

FC4A-N32B3, FC4A-T32K3, FC4A-T32S3

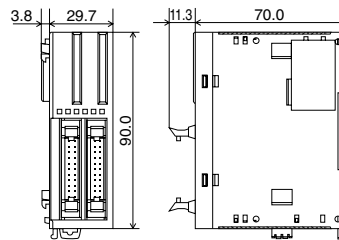

FC4A-HPH1

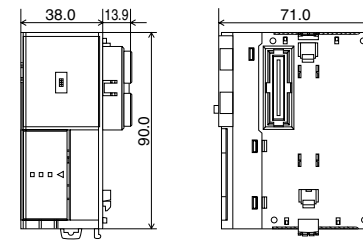

FC4A-M24BR2

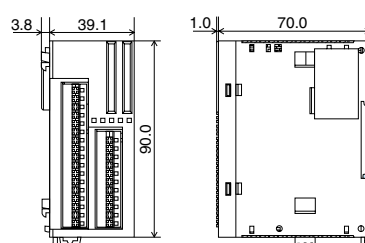

Example:  
This figure illustrates a system setup with the FC4A-C24R2 All-in-one type CPU, an 8-point relay output module, and a 16-point DC input module, mounted on a 35mm DIN rail using BNL6 mounting clips.

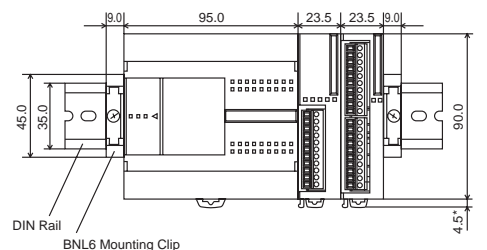

**Mounting Hole Layout**

**CPU Modules:**

**FC4A-C10R2, FC4A-C10R2C  
FC4A-C16R2, FC4A-C16R2C**

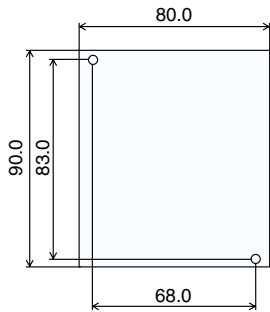

**FC4A-C24R2, FC4A-C24R2C**

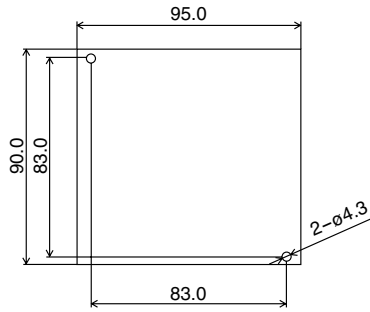

**FC4A-C20K3  
FC4A-D20S3**

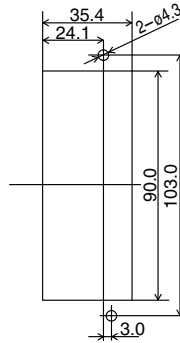

**FC4A-C20RK1, FC4A-D40K3  
FC4A-C20RS1, FC4A-D40S3**

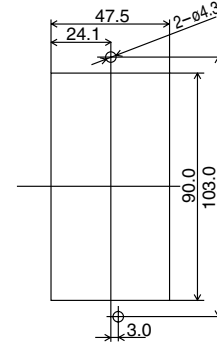

**Expansion Modules:**

**FC4A-N08B1, FC4A-N08A11,  
FC4A-N16B1, FC4A-R081,  
FC4A-R161, FC4A-T08K1,  
FC4A-T08S1, FC4A-M08BR1,  
FC4A-L03A1, FC4A-L03AP1,  
FC4A-J2A1, FC4A-K1A1**

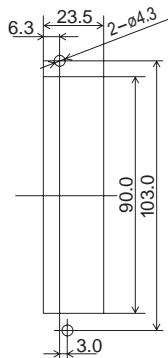

**FC4A-N16B3  
FC4A-T16K3  
FC4A-T16S3**

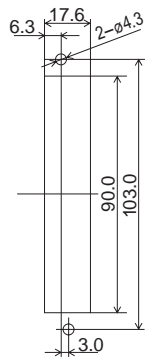

**FC4A-N32B3  
FC4A-T32K3  
FC4A-T32S3**

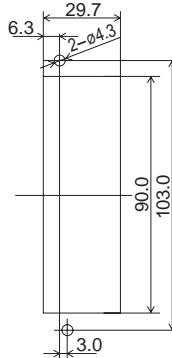

**EXAMPLE:**  
Mounting hole layout for FC4A-C24R2 and 23.5mm-wide I/O modules.

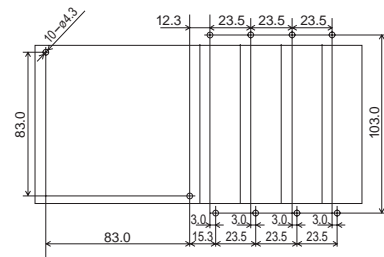

**FC4A-M24BR2**

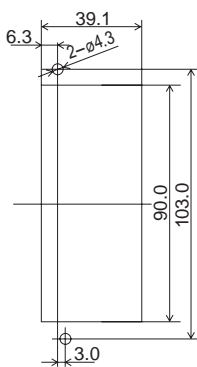

**FC4A-HP1C  
FC4A-HPC2  
FC4A-HPC3**

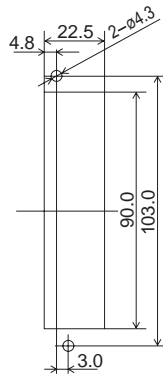

**FC4A-HPH1**

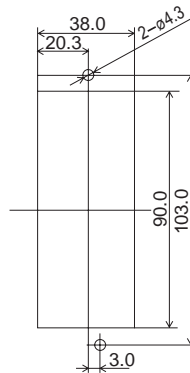

**EXAMPLE:**  
Mounting hole layout for, from left, FC4A-HPH1, FC4A-D20K3, FC4A-N16B3, FC4A-N32B3, and FC4A-M24R2 modules.

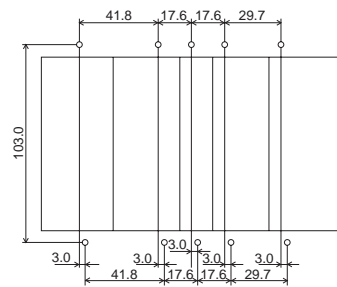

**J**  
Programmable Logic Controllers

## Usage Limits

### I/O Usage Limits

All-in-one Type CPU Modules:

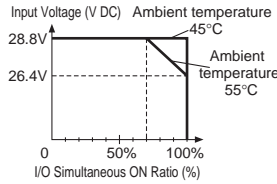
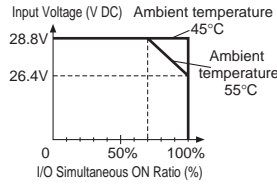
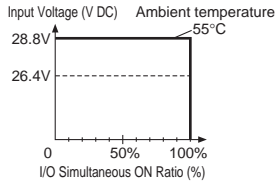

When using at an operating ambient temperature above 40°C, reduce the input voltage or the quantity of I/O points that turn on simultaneously.

Slim Type CPU Modules:

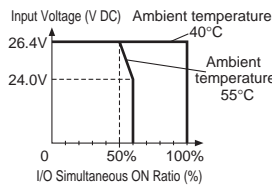
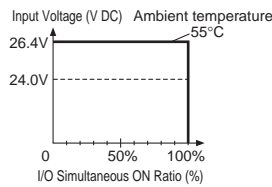
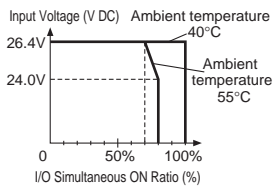

### Input Usage Limits

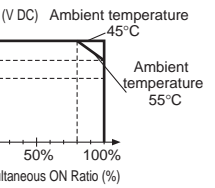
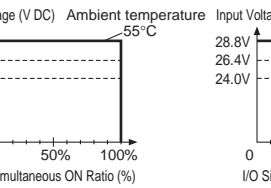
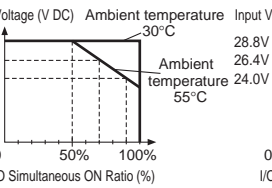
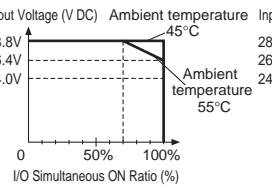
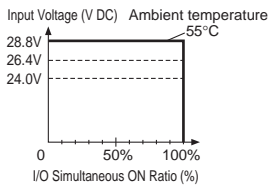

## Internal Circuits

### Input Internal Circuits

#### ALL-IN-ONE TYPE

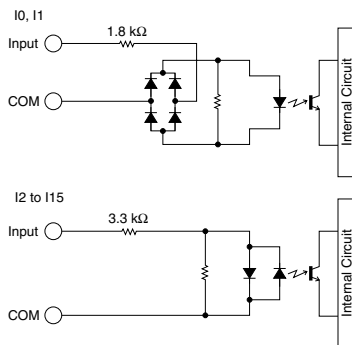

#### SLIM TYPE

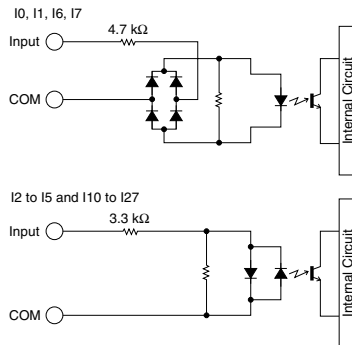

### Output Internal Circuit (Slim Type)

#### SINK OUTPUT

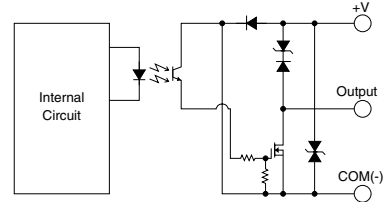

#### SOURCE OUTPUT

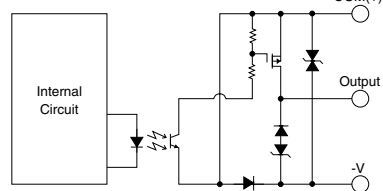

Internal Circuits

**Input Internal Circuits (Expansion Modules)**

**Output Internal Circuits**

**FC4A-N081, FC4A-N16B1**

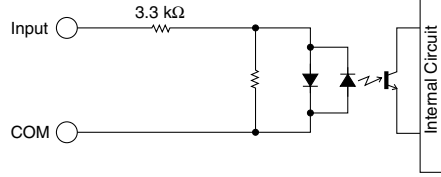

**FC4A-N16B3, FC4A-N32B3**

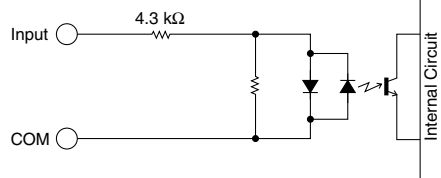

**FC4A-M08BR1, FC4A-M24BR2**

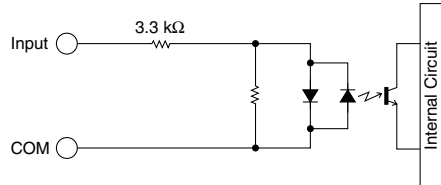

**FC4A-N08A11**

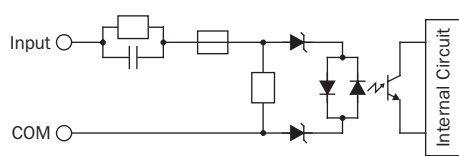

**FC4A-T08K1, FC4A-T16K3, FC4A-T32K3**

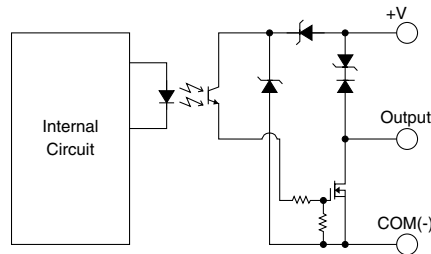

**FC4A-T08S1, FC4A-T16S3, FC4A-T32S3**

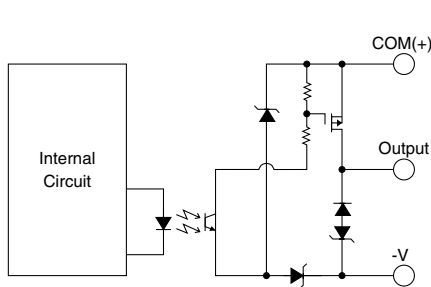

J

Programmable Logic Controllers

**Analog I/O Module**

**Input Circuit**

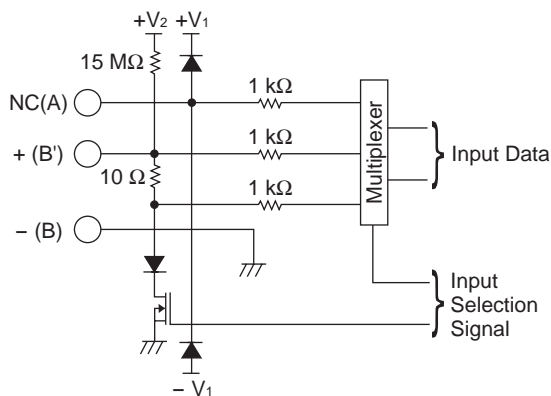

**Output Circuit**

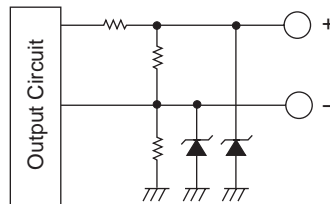



## **X-ON Electronics**

Largest Supplier of Electrical and Electronic Components

*Click to view similar products for [Switch Fixings](#) category:*

*Click to view products by [Idec](#) manufacturer:*

Other Similar products are found below :

[893102000](#) [00-5150](#) [LZZ1A](#) [0098.9234](#) [61-9451.0](#) [M2PA-5011](#) [630155](#) [635401](#) [6PA113](#) [6PA147-E6](#) [6PA148-E6](#) [6PA32](#) [6PA9](#) [700106](#)  
[700109](#) [700303A56](#) [700C1GRY](#) [700C2GRN](#) [704-6001](#) [704.960.9](#) [704.965.2](#) [704.965.6](#) [704.966.0](#) [7089-3](#) [710082-B11](#) [71M1048](#)  
[757200264](#) [764300000](#) [MHU35](#) [MHU37](#) [807039-1](#) [825.003.011](#) [825.005.011](#) [825.053.011](#) [825.055.011](#) [826.000.071](#) [827.020.011](#)  
[827.400.021](#) [835.900.023](#) [MML52C10C](#) [MML52E10C](#) [MML92HGH](#) [MML93K](#) [84211M02CNNS](#) [84212M02CNNS](#) [84217A8.0LNOS](#)  
[842.500.011](#) [843187-000](#) [843487-000](#) [84-901](#)