

BA Series Terminal Blocks

Quick-mount terminal blocks for mounting on 35-mm-wide DIN rails. Current capacities from 16A to 400V (600V).

- Snaps on to 35-mm-wide DIN rails.
- Wide range of current capacities from 16A to 400A. Insulation voltage is 600V.
- No end plates are required.
- 3-pole units, fuse blocks with blown fuse indicators available.
- Large capacity types (BA811S, BA911S) can be mounted directly to panels.
- Material: PPE (black)
- Complies with JIS C 2811.
- UL recognized and CSA certified. (BA111T, BA211T, BA311T, BA411S, BAF111SU, BAF111SNU)

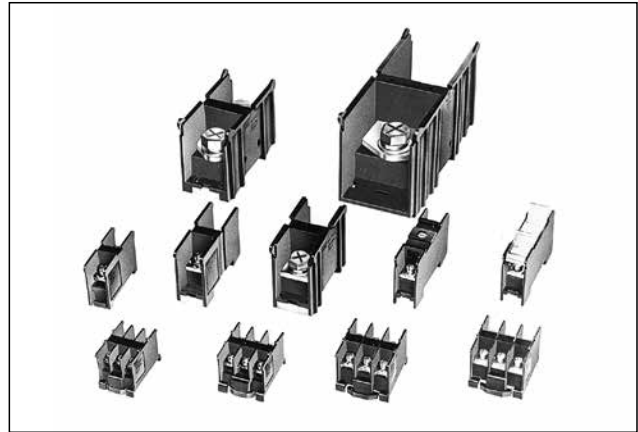

Applicable Standards	Mark	Certification Organization/ File No.
UL1059		UL recognized File No. E78117
CSA 22.2 No. 158		CSA (File No. LR64803)

Quick-mount Unlatch No end plates required

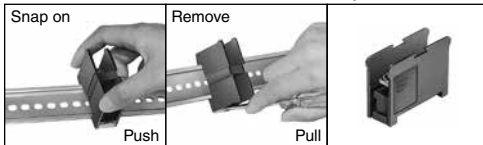

General Ratings

Dielectric Strength	2500V AC, 1 minute
Insulation Resistance	100MΩ minimum
Operating Temperature	-25 to +55°C (no freezing)
Storage Temperature	-25 to 70°C (no freezing)
Operating Humidity	45 to 85% RH (no condensation)

Terminal Blocks

Style	Part No.	Ordering No.	UL/CSA		JIS		Terminal Screw	Tightening Torque (N·m)	Package Quantity		
			Voltage/Current	Wire Size (AWG)	Voltage/Current	Wire Size (mm ²)					
3-pole	Self-Lifting	BA111T	BA111TPN20	300V/15A	22-14	600V/16A	1.25 mm ² (2 mm ²)	M3	0.6 to 1.0	20	
		BA211T	BA211TPN20	300V/20A	22-12	600V/21A	2 mm ² (3.5 mm ²)	M3.5	1.0 to 1.3	20	
		BA311T	BA311TPN20	150V/30A	18-10	600V/40A	5.5 mm ²	M4	1.4 to 2.0	20	
1-pole	Self-Lifting	BA411S	BA411SPN50	600V/40A	16-6	600V/70A	14 mm ²	M5	2.6 to 3.7	50	
		BA611S	BA611SPN10	—	—	600V/94A	22 mm ²	M6	3.9 to 5.4	10	
		BA711S	BA711SPN06	—	—	600V/132A	38 mm ²	M8	10 to 13.5	6	
	Large Capacity	BA811S	BA811SPN06	—	—	600V/240A	100 mm ²	M10	21 to 28	6	
		BA911S	BA911SPN06	—	—	600V/370A	200 mm ² (200 mm ² 2 wires) (325 mm ² 1 wire)	M12	38 to 49	6	
		Fuse	BAF111S-□	BAF111S-□PN20	—	—	600V/10A	5.5 mm ²	M4	1.4 to 2.0	20
		Fuse with Lamp	BAF111SN-□	BAF111SN-□PN20	—	—	600V/10A	5.5 mm ²	M4	1.4 to 2.0	20
	Without Fuse/ With Lamp	BAF111SU	BAF111SUPN20	600V/10A	18-10	600V/10A	5.5 mm ²	M4	1.4 to 2.0	20	
		BAF111SNU	BAF111SNUPN20	600V/10A	18-10	600V/10A	5.5 mm ²	M4	1.4 to 2.0	20	
		With Disconnecting Switch	BAT20	BAT20PN20	—	—	600V/20A	5.5 mm ²	M4	1.4 to 2.0	20

1. Specify fuse ratings 1A, 3A, or 5A in place of □ in the Part No.
2. The wire size in () does not comply with JIS standards.
3. The voltage/current differ according to operating conditions. See "Selecting Terminal Blocks by Current According to JIS Standards" on page 4.
4. Use a socket wrench or screwdriver for tightening screws.

○: Order when a marking strip or a dust cover is needed.

▲: Used for surface mounting

*: Dust cover with fuse holder

Part No.	Accessories (× Necessary)						
	DIN Rail	End Clip	Marking Strip	Dust Cover	Connecting Rod	Connecting Nut	Surface Mounting Clip
BA111T, BA411S, BAT20, BA211T, BA611S, BA711S, BA311T	×	×	○	○	—	—	—
BA811S, BA911S	×	×	○	○	×	×	▲
BAF111S□, BAF111SN□, BAF111SU, BAF111SNU	×	×	○	*	—	—	—

Material

Parts Name	Material
Housing	Polyamide
Bus Bar	Brass (nickel-plated)
Terminal Screw	Steel (zinc chrome-plated)

BA Series Terminal Blocks

BA111T (3 Pole) 16A M3

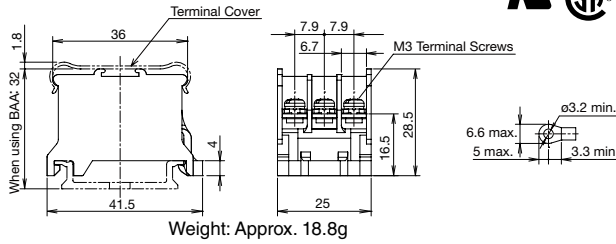

Standards	UL/CSA	JIS
Insulation Voltage	300V	600V
Rated Current *2	15A max.	16A
Dielectric Strength	2,500V AC, 1 minute	
Insulation Resistance	100 MΩ minimum	
Wire Size *1	22-14 AWG	1.25 mm ² (2 mm ²)
Accessories	Marking Strip Width	9.5 mm (BNM7, BNM9, BNM725)
	Dust Cover	BNC220
	Rail	BAP1000, BAA1000
	See page	31

BA211T (3 Pole) 21A M3.5

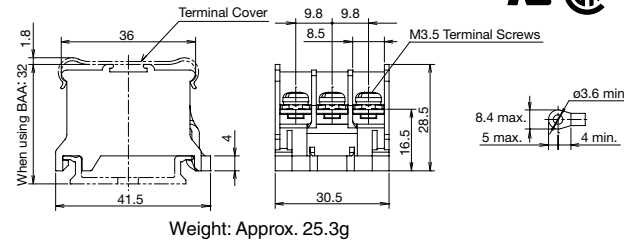

Standards	UL/CSA	JIS
Insulation Voltage	300V	600V
Rated Current *2	20A max.	21A
Dielectric Strength	2,500V AC, 1 minute	
Insulation Resistance	100 MΩ minimum	
Wire Size *1	22-12 AWG	2 mm ² (3.5 mm ²)
Accessories	Marking Strip Width	9.5 mm (BNM7, BNM9, BNM725)
	Dust Cover	BNC220
	Rail	BAP1000, BAA1000
	See page	31

BA311T (3 Pole) 40A M4

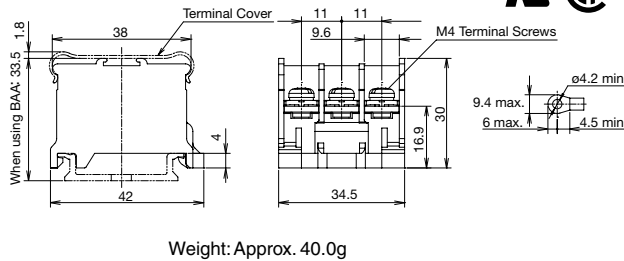

Standards	UL/CSA	JIS
Insulation Voltage	150V	600V
Rated Current *2	30A max.	40A
Dielectric Strength	2,500V AC, 1 minute	
Insulation Resistance	100 MΩ minimum	
Wire Size *1	18-10 AWG	5.5 mm ²
Accessories	Marking Strip Width	9.5 mm (BNM7, BNM9, BNM725)
	Dust Cover	BNC230
	Rail	BAP1000, BAA1000
	See page	31

BA411S 70A M5

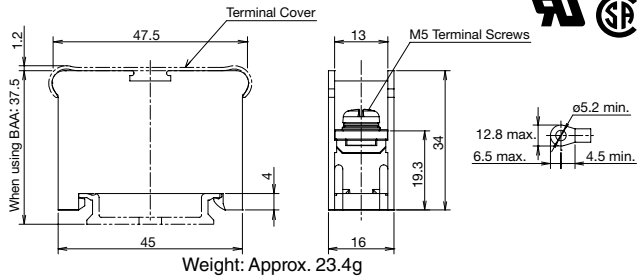

Standards	UL/CSA	JIS
Insulation Voltage	600V	600V
Rated Current *2	40A max.	70A
Dielectric Strength	2,500V AC, 1 minute	
Insulation Resistance	100 MΩ minimum	
Wire Size *1	16-6 AWG	14 mm ²
Accessories	Marking Strip Width	9.5 mm (BNM7, BNM9, BNM725)
	Dust Cover	BNC320
	Rail	BAP1000, BAA1000
	See page	31

BA611S 94A M6

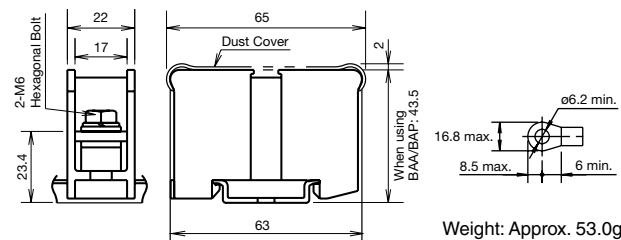
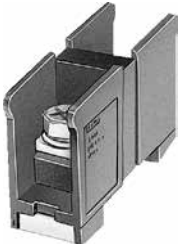

Socket wrench: 12.7 mm square drive hexagonal socket 10 *3

Insulation Voltage	600V	
Rated Current *2	94A max.	
Dielectric Strength	2,500V AC, 1 minute	
Insulation Resistance	100 MΩ minimum	
Wire Size	22 mm ²	
Accessories	Marking Strip Width	9.5 mm (BNM7, BNM9, BNM725)
	Dust Cover	BNC520
	Rail	BAP1000, BAA1000
	See page	31

BA711S 132A M8

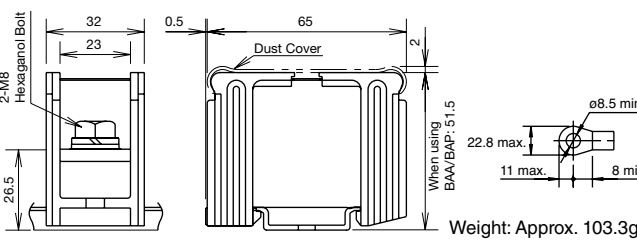
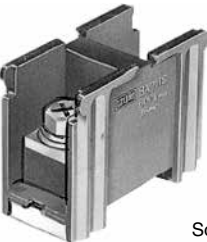

Socket wrench: 12.7 mm square drive hexagonal socket 13 *3

Insulation Voltage	600V	
Rated Current *2	132A max.	
Dielectric Strength	2,500V AC, 1 minute	
Insulation Resistance	100 MΩ minimum	
Wire Size	38 mm ²	
Accessories	Marking Strip Width	9.5 mm (BNM7, BNM9, BNM725)
	Dust Cover	BNC520
	Rail	BAP1000, BAA1000
	See page	31

*1: The wire size in () does not comply with JIS standards.

*2: The voltage/current differ according to operating conditions. See "Selecting Terminal Blocks by Current According to JIS Standards" on page 4.

*3: Screws can be tightened with a socket wrench.

*4: The grooves on the head of the hex bolt are for temporary tightening. For proper tightening, use an applicable socket wrench and tighten within the range of the recommended tightening torque.

BA Series Terminal Blocks

BA811S 240A M10



Socket wrench: 12.7 mm square drive hexagonal socket 17

Weight: Approx. 185.0g

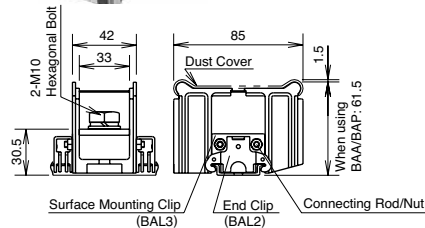

Surface Mounting

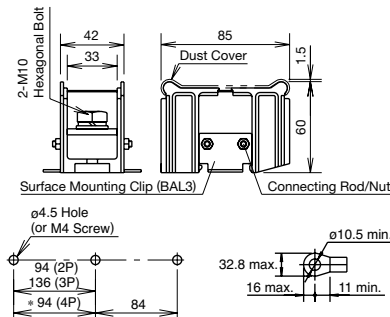

BA911S 370A M12



Socket wrench: 12.7 mm square drive hexagonal socket 19

Weight: Approx. 406.3g

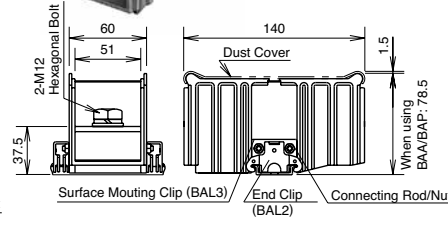

Surface Mounting

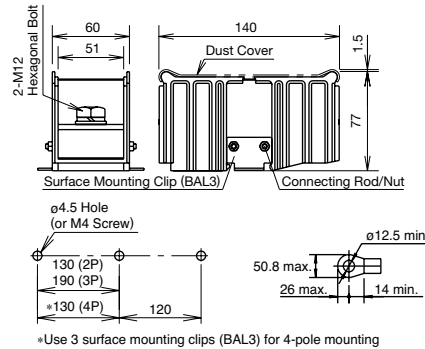

Part No.	BA811S	BA911S
Insulation Voltage	600V	
Rated Current *2	240A	370 (400A)
Dielectric Strength	2,500V AC, 1 minute	
Insulation Resistance	100MΩ minimum	
Wire Size	100 mm ²	200 mm ² *1 (200 mm ² 2 wires) (325 mm ² 1 wire)
Terminal Screw	M10	M12
Accessories	Connecting Rod	BNR1, BNR2, BNL8
	Connecting Nut	BAN1
	End Clip/ Surface Mounting Clip	BAL2, BAL3
	Marking Strip Width	9.5 mm (BNM7, BNM9, BNM725)
	Dust Cover	BAC820 BNC92
	Rail	BAP1000, BAA1000
	See page	31

BAF111S (Fuse) 10A M4

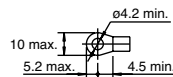
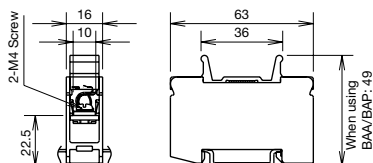

• BAF111SN is equipped with a neon lamp (for 100 or 200V AC) which turns on when the fuse is blown.

Internal Connection

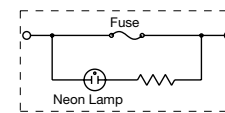

BAF111S (with fuse)/BAF111SN (with fuse/lamp)

Insulation Voltage	600V	
Rated Current	10A max. (depends on fuse rating)	
Dielectric Strength	2,500V AC, 1 minute	
Insulation Resistance	100MΩ minimum	
Wire Size	5.5 mm ²	
Terminal Screw	M4	
Accessories	Marking Strip Width	9.5mm (BNM7, BNM9, BNM725)
	Dust Cover	—
	Rail	BAP1000, BAA1000
	See page	31

• Fuse ratings
Rated voltage: 250V
Rated current: 1, 3, 5A
Cartridge fuse: JIS C6575-2
6.35×31.8 mm

Part No.
BAF111S-1A
BAF111S-3A
BAF111S-5A
BAF111SN-1A
BAF111SN-3A
BAF111SN-5A

BAF111S (with fuse)/BAF111SN (without fuse/with lamp)

Insulation Voltage	600V	
Rated Current	10A max. (depends on fuse rating)	
Dielectric Strength	2,500V AC, 1 minute	
Insulation Resistance	100 MΩ minimum	
Wire Size	18-10 AWG	
Terminal Screw	M4	
Accessories	Marking Strip Width	9.5 mm (BNM7, BNM9, BNM725)
	Dust Cover	—
	Rail	BAP1000, BAA1000
	See page	31

• Use UL/CSA approved fuses (10A maximum)
• Fuse size
6.35×31.8 mm
6.40×30 mm

BAT20 (With Disconnecting Switch) 20A M4

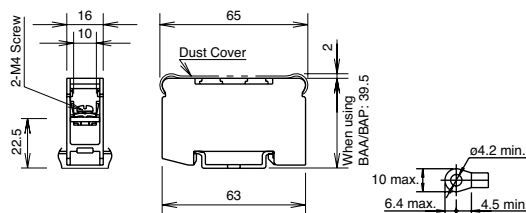
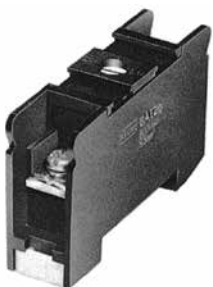

Insulation Voltage	600V	
Rated Current	20A	
Dielectric Strength	2,500V AC, 1 minute	
Insulation Resistance	100 MΩ minimum	
Wire Size	5.5 mm ² max.	
Terminal Screw	M4	
Accessories	Marking Strip Width	9.5 mm (BNM7, BNM9)
	Dust Cover	BNC520
	Rail	BAP1000, BAA1000
	See page	31

BAT20 is not capable of breaking circuits. Do not apply voltage when opening or closing the circuit. Turn the slot using a screwdriver.

*1: The wire size in () does not comply with JIS standards.

*2: The rated current differs according to operating conditions. See "Selecting Terminal Blocks by Current According to JIS Standards" on page 4.

*3: The grooves on the head of the hex bolt are for temporary tightening. For proper tightening, use an applicable socket wrench and tighten within the range of the recommended tightening torque.

Accessories

Rails

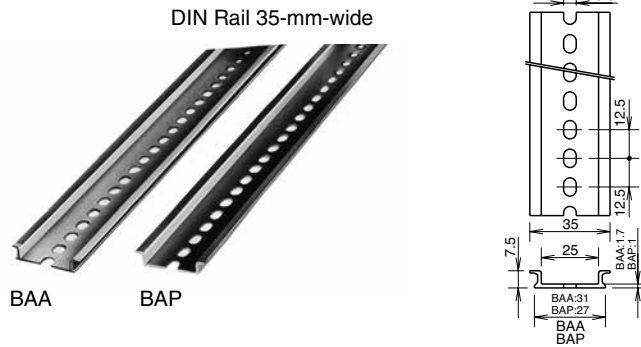

Length	Part No.	Ordering No.	Material	Weight (Approx.)	Package Quantity
1000 mm	BAA1000 (Note)	BAA1000PN10	Aluminum	200g	10
	BAP1000	BAP1000PN10	Steel	320g	10

Note: 2000 mm is also available. Contact IDEC.

Marking Strip (BNM)

Part No.	Ordering No.	Package Quantity	Dimensions	Material
BNM7	BNM7PN10	10	9.5 × 0.5t × 1m	PVC (glossy surface)
BNM9	BNM9PN10	10	9.5 × 0.5t × 1m	Fiber Glass (matte surface)
BNM725	BNM725	1	9.5 × 0.5t × 25m	PVC (glossy surface)

End Clip

Used on the ends of a group of terminal blocks to secure and prevent sliding along the rails.

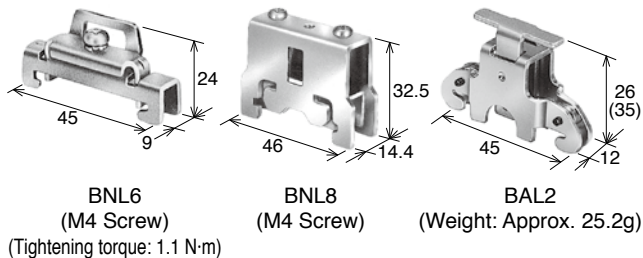

Material: Steel (zinc chrome-plated)

Part No.	Ordering No.	Package Quantity
BNL6	BNL6PN10	10
BNL8	BNL8PN10	10
BAL2	BAL2PN10	10

Notes on Selecting End Clips

- When using BA611S, use BAL2 or BNL8. Also, when using BA711S, BA811S, BA911S of 100A or larger, use BAL2 or BNL8.
- When mounting rails vertically, use BAL2 or BNL8.

Dust Cover

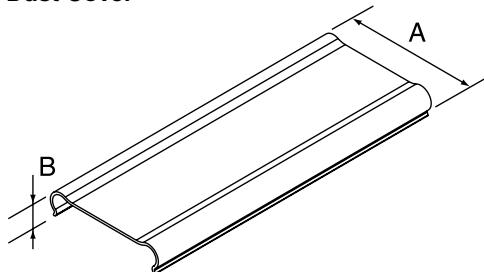

Material: Polycarbonate

Item	Part No.	Ordering No.	Size (mm)		Terminal Block	Package Quantity
			A	B		
Dust Cover (1m)	BNC220	BNC220PN10	37.6	8.5	BA111T, BA211T	10
	BNC230	BNC230PN10	39.6	8.5	BA311T	10
	BNC320	BNC320PN10	49.6	8.5	BA411S	10
	BNC520	BNC520PN10	65.0	9.0	BA611S, BA711S, BAT20	10
	BAC820	BAC820PN10	85.0	10.6	BA811S	10
Dust Cover (500 mm)	BNC92	BNC92PN10	140.5	9.8	BA911S	10

BA Series Terminal Blocks

Connecting Rod/Connecting Nut (For BA811S, BA911S)



BNR1: M4 × 0.7 L = 265 (21.0g)
BNR2: M4 × 0.7 L = 500 (43.0g)



BAN1: M4 × 0.7 (2.5g)

Item	Part No.	Ordering No.	Weight (Approx.)	Package Quantity	Remarks
Connecting Rod (265 mm)	BNR1	BNR1PN10	2.6g	10	M4 × 0.7
Connecting Rod (500 mm)	BNR2	BNR2PN10	43g	10	M4 × 0.7
Connecting Nut (4 pcs/set)	BAN1	BAN1PN10	2.5g	10	M4 × 0.7

Surface Mounting Clip (For BA811S and BA911S Only)



Used on the ends of groups of terminal blocks for direct mounting to panels.

Material: Steel (zinc-chrome plated)

Part No.	Ordering No.	Weight (approx.)	Package Quantity
BAL3	BAL3PN10	12.4g	10

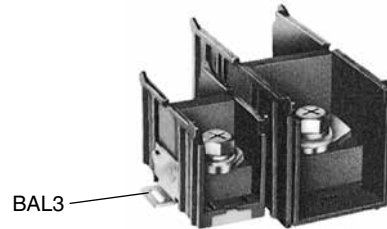

Calculating Rail / Connecting Rod Length

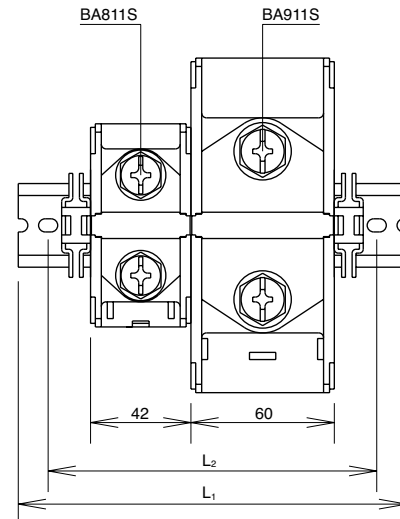
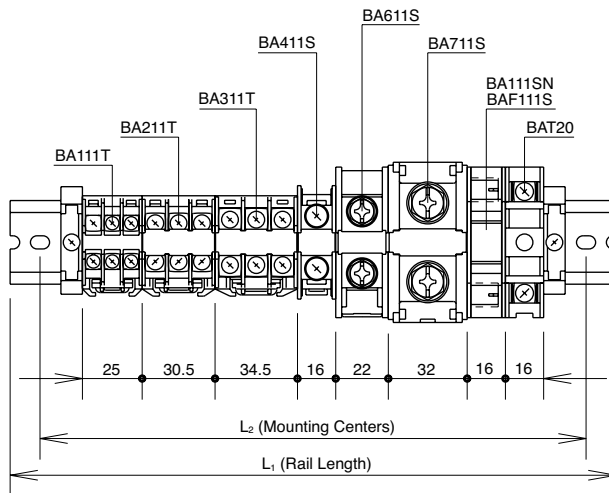

Calculating Rail Length

For BAA, BAP rails

$$L_1 = 12.5 \times N$$

$$L_2 = L_1 - 25$$

A: Total thickness of each terminal block

B: Tolerance of stacking thickness

0.1 mm per block

C: End Clip

When using 2 pieces of BNL6 or BAL2 = 62.5

N: Rounded up numerical number from the calculated value of M.

(Example: N for 19.1 is 20)

$$M = \frac{A + B + C}{12.5}$$

Note: This formula is for calculating the maximum rail length including tolerance. The rail length may be shorter than the calculated value, depending on how the terminal blocks are combined.

Calculating Connecting Rod Length

$$L = 42 \times n_1 + 60 \times n_2 + 10.2$$

n₁: BA811S

n₂: BA911S

n: The number of terminal blocks

Instructions

Installation of BA811S and BA911S

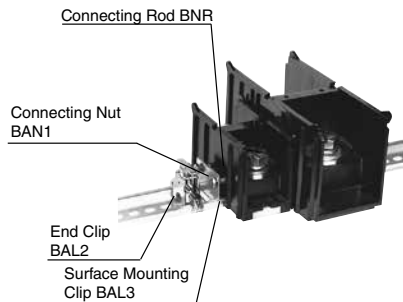

Rail Mount

1. Mount the terminal block on DIN rail.
2. Mount the surface mounting clips (BAL3) on both ends and slide 2 connecting rods (BNR) through the holes in the terminal blocks.
3. Tighten both ends of the connecting rod with a connecting nut (BAN1).
4. Secure the terminal blocks with end clips (BAL2).

Surface Mount

1. Mount the terminal block to the panel.
2. Mount the surface mounting clips (BAL3) on both ends and slide 2 connecting rods (BNR) through the holes in the terminal blocks.
3. Tighten both ends of the connecting rod with connecting nuts (BAN1).
4. Secure the terminal blocks to the panel.

Notes on Wiring

Crimping Terminals

- When using crimping terminals, be sure to use insulated terminals to prevent electric shocks.

Without Crimping Terminals

- Insert the wire until the insulation comes into contact with the terminal metal part.
- Strip the insulation so that the wire is longer than the width of the wire clamp.
- When connecting two wires, use wires of the same size.

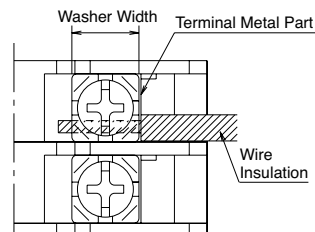

X-ON Electronics

Largest Supplier of Electrical and Electronic Components

Click to view similar products for [Other Tools](#) category:

Click to view products by [Idec](#) manufacturer:

Other Similar products are found below :

[CR-05FL7--150R](#) [CR-05FL7--698K](#) [899-2-KT46](#) [899-5-KT46](#) [CR-0AFL4--332K](#) [CR-12FP4--260R](#) [CRCW04021100FRT7](#)
[CRCW04021961FRT7](#) [5800-0090](#) [CRCW04024021FRT7](#) [CRCW040254R9FRT7](#) [CRCW0603102JRT5](#) [59065-5](#) [00-8273-RDPP](#) [00-8729-](#)
[WHPP](#) [593033](#) [593058](#) [593072](#) [593564100](#) [593575](#) [593591](#) [593593](#) [011349-000](#) [LTLA506SBLAMNBL](#) [CRCW08052740FRT1](#) [LUC-](#)
[012S070DSM](#) [LUC-018S070DSP](#) [599-2021-3-NME](#) [599-JJ-2021-03](#) [00-5080-YWPP](#) [5E4750/01-20R0-T/R](#) [LW1A-L1-GL](#) [LW1A-P1-GD](#)
[LW1L-A1C10V-GL](#) [LW1L-M1C70-A](#) [0202-0173](#) [00-9089-RDPP](#) [00-9300-RDPP](#) [CRCW2010331JR02](#) [01-1003W-8/32-10](#) [601-GP-08-](#)
[KT39](#) [601-JJ-06](#) [601-SPB](#) [601YSY](#) [602-JJ-03](#) [602SPB](#) [602Z](#) [603-JJ-07-FP](#) [603-JJY-04](#) [604J](#)