

Terminal Blocks

BN-W BNH-W Series



UL recognized, CSA certified, and TÜV compliant.
Self-lifting and touch-down terminals available.



• See website for details on approvals and standards.

Touch-down terminal blocks reduce wiring time. (BNH-W/BNDH-W Series)

1. Insert the Crimping Terminal



Terminal screw is always in the open position. No need to loosen the screw.

2. Push the Screw Down

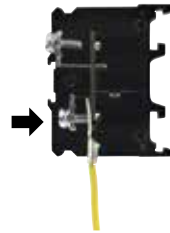

Push the screw down to temporarily hold the wire in place.

3. Tighten the Screw



The screws can be tightened easily with a pneumatic screwdriver.

- Molded from UL94V-0 material with excellent flame and shock resistance.
- Terminal blocks can be mounted on a 35-mm-wide DIN rail and 30-mm-wide IEC type C rail.

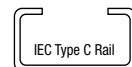

- 9.5-mm-wide marking strips can be used on all models. 17-mm-wide sliding type marking strips also available. (BN10W to BN30W)
- Terminal blocks of different shapes and capacities can be installed without using an end plate. (BN/BNH10W to BN/BNH30W)
- Screw and stud terminals available for large capacity terminal blocks.
- Additional mounting and removal of terminals is easy. (BN□10W to BN□150W)
- Complies with JIS C 8201-7-1.
- UL recognized, CSA certified, and EN compliant (TÜV approved). (Except common terminal)
- UL recognized for field wiring (FW2).

BN-W / BNH-W Series Terminal Blocks

UL recognized, CSA certified, and TÜV compliant.
Touch-down terminals reduce wiring time.



General Ratings

Dielectric Strength	2500V AC, 1 minute
Insulation Resistance	100 MΩ minimum
Operating Temperature	-25 to +55°C (no freezing)
Storage Temperature	-25 to +70°C (no freezing)
Operating Humidity	45 to 85% RH (no condensation)

Material

Parts Name	Material
Housing	Modified PPE
Bus Bars	Brass (Nickel-plated)
Terminal Screw	Steel (Zinc chrome-plated)
Spring	Stainless steel (touch-down type only)

Ratings/Terminal Screw Tightening Torque

Style	Part No.		UL/CSA Ratings		EN Ratings (*1)		JIS Ratings		Terminal Screw	Tightening Torque (N·m)
	Self-Lifting	Touch-Down	Voltage/Current	Wire Size (AWG)	Voltage/Current	Wire Size [mm ² /(AWG)]	Voltage/Current	Wire Size (mm ²)		
Standard	BN10W ★	BNH10W ★	600V/15A	22-16	660V/16A	1.25/(22-16)	800V/16A	1.25	M3	0.6 to 1.0
	BN15MW ★	BNH15MW ★	600V/15A	22-14	660V/22A	2/(22-14)	800V/16A	1.25 (2) *2	M3	0.6 to 1.0
	BN15LW ★	BNH15LW ★	600V/20A	22-14	660V/22A	2/(22-14)	630V/21A	2	M3.5	1.0 to 1.3
	BN15MWT ★	BNH15MWT ★	600V/15A	22-14	660V/22A	2/(22-14)	800V/21A	2	M3.5	1.0 to 1.3
	BN15LWT ★	BNH15LWT ★	600V/30A	22-14	660V/22A	3.5/(22-14)	630V/30A	3.5	M4	1.4 to 2.0
	BN30W ★	BNH30W ★	600V/35A	18-10	660V/38A	5.5/(18-10)	630V/40A	5.5	M4	1.4 to 2.0
	BN40W	BNH40W	600V/40A	16-8	660V/50A	8/(16-8)	630V/50A	8	M5	2.6 to 3.7
	BN50W	BNH50W	600V/60A	16-6	660V/67A	14/(16-6)	800V/70A	14	M5	2.6 to 3.7
Large Capacity	BN75W ★		600V/80A	16-4	660V/94A	22/(8-4)	1000V/94A	22	M6	3.9 to 5.4
	BN100W		600V/100A	16-2	660V/132A	38/(2)	1000V/132A	38	M8	10 to 13.5
	BN150W		600V/150A	16-1/0	660V/175A	60/(1/0)	1000V/175A	60	M8	
	BN150NW		600V/150A	16-1/0	660V/175A	60/(1/0)	630V/175A	60	M8	10 to 13.5
	BN200BW□, BN200NW□		600V/200A	4/0	660V/240A	100/(4/0)	800V/240A	100	M10	21 to 28
	BN300BW□, BN300NW□		600V/310A	300MCM	660V/310A	150/(300MCM)	800V/310A	150	M10	
	BN400BW□, BN400NW□		600V/350A	400MCM	660V/370A	200/(400MCM)	800V/370A	200	M12	38 to 49
	BN500BW□, BN500NW□		600V/500A	500MCM	660V/430A	240/(500MCM)	800V/430A	250	M16	83 to 116
BN600NW□K		600V/600A	600MCM	660V/520A	300/(600MCM)	800V/520A	325	M16		
With Disconnecting Switch	BNT20	—	—	—	—	—	600V/20A	5.5	M4	1.4 to 2.0
With Fuse	BNF10S	—	—	—	—	—	600V/10A	5.5	M4	1.4 to 2.0
	BNF10N	—	—	—	—	—	600V/10A	5.5	M4	
Double-Deck	BND15W	BNDH15W	600V/10A	22-14	660V/22A	2/(22-14)	800V/16A	1.25 (2) *2	M3	0.6 to 1.0
	BND15LW	BNDH15LW	600V/15A	22-14	660V/22A	2/(22-14)	800V/21A	2	M3.5	1.0 to 1.3
	BND15WT	BNDH15WT	600V/15A	22-14	660V/22A	2/(22-14)	800V/21A	2	M3.5	1.0 to 1.3
Common Terminal	BN15MC□	—	—	—	—	—	600V/16A Common Current	1.25 (2) *2	M3	0.6 to 1.0

*1: Ratings approved by TÜV based on EN60947-7-1.

*2: The rated applicable wire size is 1.25 mm², but 2 mm² wires can also be connected. The wire size in () does not comply with JIS standards.

*3: Part No. with ★ is UL recognized for field wiring (FW2).

Specify the number of poles in place of □.



Download catalogs and CAD from <http://eu.idec.com/downloads>

BN-W / BNH-W Series Terminal Blocks

Terminal Blocks

Terminal Style		Part No.	Ordering No.	Applicable Wire (mm ²)	Terminal Screw	Width (mm)	Package Quantity	Page	
Standard									
Self-Lifting	1-pole	16A	BN10W	BN10WPN50	1.25	M3	7	50	
			BN15MW	BN15MWP50	1.25 (2) (Note)	M3	8	50	G-012
		21A	BN15LW	BN15LWPN50	2	M3.5	10.5	50	G-013
			BN15MWT	BN15MWT50	2	M3.5	8	50	
			30A	BN15LWT	BN15LWTPN50	3.5	M4	10.5	
		40A	BN30W	BN30WPN50	5.5	M4	12	50	G-014
		50A	BN40W	BN40WPN20	8	M5	14	20	
70A	BN50W	BN50WPN20	14	M5	15.5	20			
Touch-Down	1-pole	16A	BNH10W	BNH10WPN50	1.25	M3	7	50	
			BNH15MW	BNH15MWP50	1.25 (2) (Note)	M3	8	50	G-012
		21A	BNH15LW	BNH15LWPN50	2	M3.5	10.5	50	G-013
			BNH15MWT	BNH15MWT50	2	M3.5	8	50	
			30A	BNH15LWT	BNH15LWTPN50	3.5	M4	10.5	
		40A	BNH30W	BNH30WPN50	5.5	M4	12	50	G-014
		50A	BNH40W	BNH40WPN20	8	M5	14	20	
70A	BNH50W	BNH50WPN20	14	M5	15.5	20			
Large Capacity (Rail Mount)									
Screw	1-pole	94A	BN75W	BN75WPN10	22	M6	20	10	
			132A	BN100W	BN100WPN05	38	M8	26	5
		175A	BN150W	BN150WPN05	60	M8	26	5	G-016
			BN150NW	BN150NWP05	60	M8	26	5	
	2-pole	240A	BN200BW2	BN200BW2	100	M10	37	1	G-017
	3-pole		BN200BW3	BN200BW3					
	4-pole		BN200BW4	BN200BW4					
	2-pole	310A	BN300BW2	BN300BW2	150	M10	44	1	G-018
	3-pole		BN300BW3	BN300BW3					
	4-pole		BN300BW4	BN300BW4					
	2-pole	370A	BN400BW2	BN400BW2	200	M12	57	1	G-019
	3-pole		BN400BW3	BN400BW3					
	4-pole		BN400BW4	BN400BW4					
	Stud	2-pole	240A	BN200NW2	BN200NW2	100	M10	37	1
3-pole		BN200NW3		BN200NW3					
4-pole		BN200NW4		BN200NW4					
2-pole		310A	BN300NW2	BN300NW2	150	M10	44	1	G-018
3-pole			BN300NW3	BN300NW3					
4-pole			BN300NW4	BN300NW4					
2-pole		370A	BN400NW2	BN400NW2	200	M12	57	1	G-019
3-pole			BN400NW3	BN400NW3					
4-pole	BN400NW4		BN400NW4						

Note The rated applicable wire size is 1.25 mm², but 2 mm² wires can also be connected.
The wire size in () does not comply with JIS standards.

Terminal Blocks

Terminal Style		Part No.	Ordering No.	Applicable Wire (mm ²)	Terminal Screw	Width (mm)	Package Quantity	Page	
Large Capacity (Surface Mount)									
Screw	2-pole	240A	BN200BW2K	BN200BW2K	100	M10	37	1	G-017
	3-pole		BN200BW3K	BN200BW3K					
	4-pole		BN200BW4K	BN200BW4K					
	2-pole	310A	BN300BW2K	BN300BW2K	150	M10	44	1	G-018
	3-pole		BN300BW3K	BN300BW3K					
	4-pole		BN300BW4K	BN300BW4K					
	2-pole	370A	BN400BW2K	BN400BW2K	200	M12	57	1	G-019
	3-pole		BN400BW3K	BN400BW3K					
	4-pole		BN400BW4K	BN400BW4K					
	2-pole	430A	BN500BW2K	BN500BW2K	250	M16	57	1	G-020
	3-pole		BN500BW3K	BN500BW3K					
	4-pole		BN500BW4K	BN500BW4K					
Stud	2-pole	240A	BN200NW2K	BN200NW2K	100	M10	37	1	G-017
	3-pole		BN200NW3K	BN200NW3K					
	4-pole		BN200NW4K	BN200NW4K					
	2-pole	310A	BN300NW2K	BN300NW2K	150	M10	44	1	G-018
	3-pole		BN300NW3K	BN300NW3K					
	4-pole		BN300NW4K	BN300NW4K					
	2-pole	370A	BN400NW2K	BN400NW2K	200	M12	57	1	G-019
	3-pole		BN400NW3K	BN400NW3K					
	4-pole		BN400NW4K	BN400NW4K					
	2-pole	430A	BN500NW2K	BN500NW2K	250	M16	57	1	G-020
	3-pole		BN500NW3K	BN500NW3K					
	4-pole		BN500NW4K	BN500NW4K					
	2-pole	520A	BN600NW2K	BN600NW2K	325	M16	57	1	G-020
	3-pole		BN600NW3K	BN600NW3K					
	4-pole		BN600NW4K	BN600NW4K					

Terminal Style		Part No.	Ordering No.	Applicable Wire (mm ²)	Terminal Screw	Width (mm)	Package Quantity	Page	
With Disconnecting Switch, Fuse									
Disconnecting Switch	20A	1-pole	BNT20	BNT20PN20	5.5	M4	15	20	G-021
With Fuse	10A	1-pole	BNF10S-□	BNF10S-□APN20	5.5	M4	15	20	
Double-Deck Terminal Block									
Self-Lifting	16A	1-pole	BND15W	BND15WPN25	1.25 (2)*	M3	8	25	G-022
Touch-Down			BNDH15W	BNDH15WPN25					
Self-Lifting	21A	1-pole	BND15LW	BND15LWPN25	2	M3.5	8	25	G-023
Touch-Down			BNDH15LW	BNDH15LWPN25					
Self-Lifting	21A	1-pole	BND15WT	BND15WTPN25	2	M3.5	12	25	G-023
Touch-Down			BNDH15WT	BNDH15WTPN25					
Common Terminal									
Self-Lifting Type 16A (Common Current)	4-pole	BN15MC4	BN15MC4PN10	1.25 (2)*	M3	8	10	G-024	
	8-pole	BN15MC8	BN15MC8PN10						
	10-pole	BN15MC10	BN15MC10PN10						

* The wire size in () does not comply with JIS standards.
The rated applicable wire size is 1.25 mm², but 2 mm² wires can also be connected.
Specify the fuse rating in place of □. 1A: 1, 3A: 3, 5A: 5.



BN-W / BNH-W Series Terminal Blocks

Accessories

When ordering accessories, check if the accessories are necessary by referring to the table.

×: Necessary

○: Optional

Terminal		Part No.	Accessories (×: Necessary)												
			End Plate	Rail	End Clip	Rail Mounting Clip	Dust Cover	Marking Strip	Marking Strip Fastener	Sliding Marking Strip	Jumper	Removal Tool	Surface Mount Clip	Connecting Rod	Connecting Nut
Standard	16A to 40A Self-Lifting Touch-Down	BN10W, BN15MW, BN15LW, BN15MWT, BN15LWT, BN30W	×	×	×	○	○	○	○	○	○	○	—	—	—
	50A to 70A Self-Lifting Touch-Down	BNH10W, BNH15MW, BNH15LW, BNH15MWT, BNH15LWT, BNH30W	×	×	×	○	○	○	○	—	○	○	—	—	—
	50A to 70A Self-Lifting Touch-Down	BN40W, BN50W, BNH40W, BNH50W	×	×	×	○	○	○	○	—	○	—	—	—	—
Large Capacity	Rail Mount 1-Pole 94A to 175A	BN75W, BN100W, BN150W, BN150NW	×	×	×	○	○	○	○	—	—	—	—	—	—
	Rail Mount 240A to 370A	BN200BW□, BN300BW□, BN400BW□ BN200NW□, BN300NW□, BN400NW□	—	×	×	—	Supplied	Supplied	—	—	—	—	—	—	—
	Surface Mount 240A to 520A	BN200BW□K, BN300BW□K, BN400BW□K BN200NW□K, BN300NW□K, BN400NW□K BN500BW□K, BN500NW□K, BN600NW□K	—	—	—	—	Supplied	Supplied	—	—	—	—	—	—	—
	With Disconnecting Switch	BNT20	×	×	×	○	○	○	○	—	—	—	—	—	—
	With Fuse	BNF10S-□A, BNF10N-□A	×	×	×	○	—	○	○	—	—	—	—	—	—
	Double-Deck	BND15W, BND15LW, BNDH15W, BNDH15LW, BND15WT, BNDH15WT	×	×	×	○	○	○	○	—	×	—	×	×	×
	Common Terminal	BN15MC□	—	×	×	—	○	○	○	○	—	—	—	—	—
			G-025		G-026		G-027		G-028		G-029				
Page															

*1: Accessory not necessary for surface mounting.

*2: Accessory not necessary for rail mounting.

Specify the number of poles in place of □.

Standard	Self-Lifting Terminal	Part No.	BN10W	16A	M3	BN15MW	16A	M3	BN15LW	21A	M3.5						
		Dimensions				Ordering No.	BN10WPN50	BN15MWP50	BN15LWPN50	Package Quantity	50	50	50				
		Weight (Approx.)	6.5g	7.3g	10g	Standard	Touch-Down Terminal	Part No.	BNH10W	16A	M3	BNH15MW	16A	M3	BNH15LW	21A	M3.5
Dimensions				Ordering No.	BNH10WPN50			BNH15MWP50	BNH15LWPN50	Package Quantity	50	50	50	Weight (Approx.)	7.5g	8.2g	11.2g
Specification / Ratings	Standards	UL/CSA	EN	JIS	UL/CSA	EN	JIS	UL/CSA	EN	JIS							
	Insulation Voltage	600V	660V	800V	600V	660V	800V	600V	660V	630V							
	Wire Size *1	22-16 AWG	1.25 mm ² (22-16 AWG)	1.25 mm ²	22-14 AWG	2 mm ² (22-14 AWG)	1.25 mm ² (2mm ² max)	22-14 AWG	2 mm ² (22-14 AWG)	2 mm ²							
	Rated Current *2	15A	16A	16A	15A	22A	16A	20A	22A	21A							
	Terminal screw	M3			M3			M3.5									
	Crimping Terminal	1.25-3			1.25-3 (2-3)			2-3.5									
	Max. No. of Crimping Terminals	2			2			2									
Tightening Torque	0.6 to 1.0 N·m			0.6 to 1.0 N·m			1.0 to 1.3 N·m										
Crimping Terminal Dimensions (mm) *3																	
Accessories *4	End Plate	BNE15W															
	Dust Cover	BNC230															
	Marking Strip	PVC 1m/BNM7, Fiber glass 1m/BNM9, PVC 25m/BNM725															
	Marking Strip Fastner	BNM3															
	DIN Rail/End Clip	Aluminum: BAA1000, Steel: BAP1000/BNL6															
	C Rail/End Clip	Aluminum: BNCA1000/BNL7															
DIN + C Rail/End Clip	Aluminum: BNJA1000/BNL6, BNL7																

*1: The wire size in () does not comply with JIS standards.

*2: The rated current differs according to operating conditions. See "Selecting Terminal Blocks by Current According to JIS Standards" on G-006.



*3: Use a CSA certified crimping terminal when using the terminal block as a CSA certified product.

*4: See G-025 for details on accessories.



- APEM
- Switches & Pilot Lights
- Control Boxes
- Emergency Stop Switches
- Enabling Switches
- Safety Products
- Explosion Proof
- Terminal Blocks
- Relays & Sockets
- Circuit Protectors
- Power Supplies
- LED Illumination
- Controllers
- Operator Interfaces
- Sensors
- AUTO-ID
- BN

BN-W / BNH-W Series Terminal Blocks

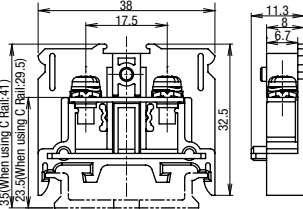
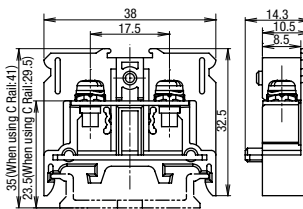
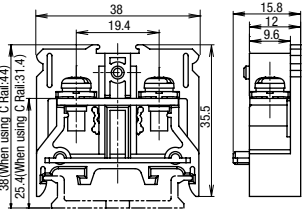
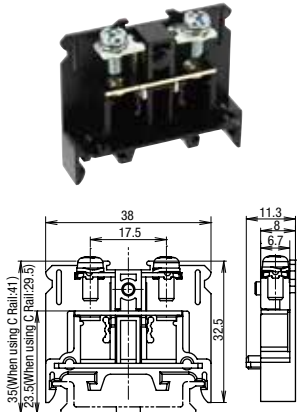
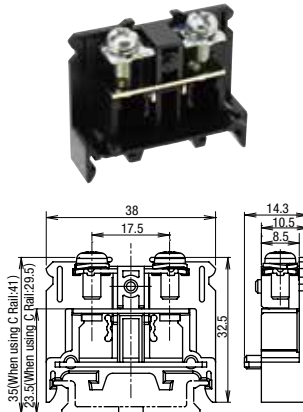
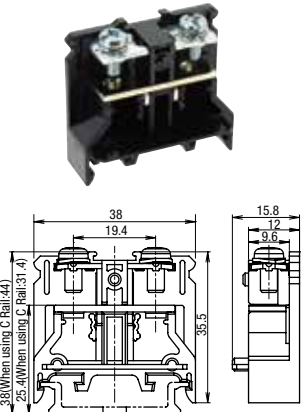
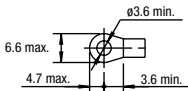
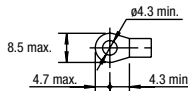
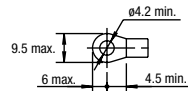
	Part No.	BN15MWT	21A	M3.5	BN15LWT	30A	M4	BN30W	40A	M4
		Self-Lifting Terminal								
Standard	Dimensions									
	Ordering No.	BN15MWTPN50			BN15LWTPN50			BN30WPN50		
	Package Quantity	50			50			50		
	Weight (Approx.)	7g			10g			15.6g		
Touch-Down Terminal	Part No.	BNH15MWT	21A	M3.5	BNH15LWT	30A	M4	BNH30W	40A	M4
	Dimensions									
	Ordering No.	BNH15MWTPN50			BNH15LWTPN50			BNH30WPN50		
	Package Quantity	50			50			50		
Weight (Approx.)	8g			11g			16.8g			
Specification / Ratings	Standards	UL/CSA	EN	JIS	UL/CSA	EN	JIS	UL/CSA	EN	JIS
	Insulation Voltage	600V	660V	800V	600V	660V	630V	600V	660V	630V
	Wire Size *1	22-14 AWG	2 mm ² (22-14 AWG)	2 mm ²	22-14 AWG	3.5 mm ² (22-14 AWG)	3.5 mm ²	18-10 AWG	5.5 mm ² (18-10 AWG)	5.5 mm ²
	Rated Current *2	15A	22A	21A	30A	22A	30A	35A	38A	40A
	Terminal screw	M3.5			M4			M4		
	Crimping Terminal	1.25-3.5 to 2-3.5			1.25-4 to 3.5-4			1.25-4 to 5.5-4		
	Max. No. of Crimping Terminals	2			2			2		
Tightening Torque	1.0 to 1.3 N·m			1.4 to 2.0 N·m			1.4 to 2.0 N·m			
Crimping Terminal Dimensions (mm) *3										
	End Plate			BNE15W			BNE30W			
	Dust Cover			BNC230			BNC230			
Accessories *4	Marking Strip			PVC 1m/BNM7, Fiber glass 1m/BNM9, PVC 25m/725						
	Marking Strip Fastner			BNM3						
	DIN Rail/End Clip			Aluminum: BAA1000, Steel: BAP1000/BNL6						
	C Rail/End Clip			Aluminum: BNCA1000/BNL7						
	DIN + C Rail/End Clip			Aluminum: BNJA1000/BNL6, BNL7						

*1: The wire size in () does not comply with JIS standards.

*2: The rated current differs according to operating conditions. See "Selecting Terminal Blocks by Current According to JIS Standards" on G-006.

*3: Use a CSA certified crimping terminal when using the terminal block as a CSA certified product.

*4: See G-025 for details on accessories.

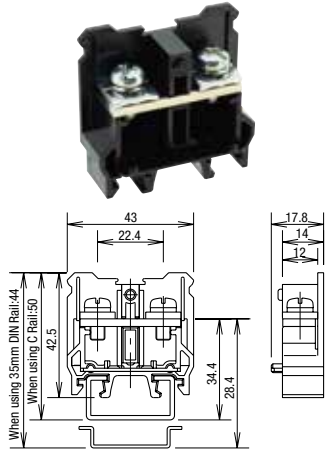
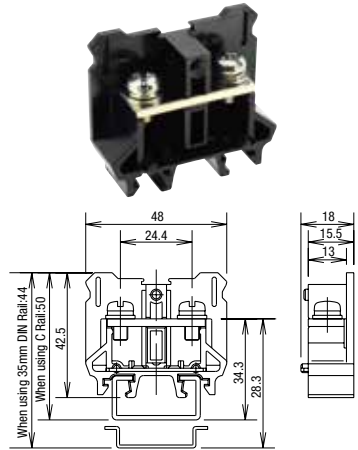
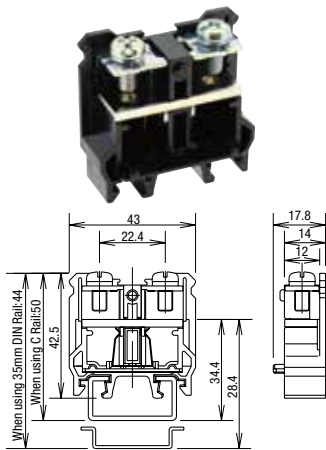
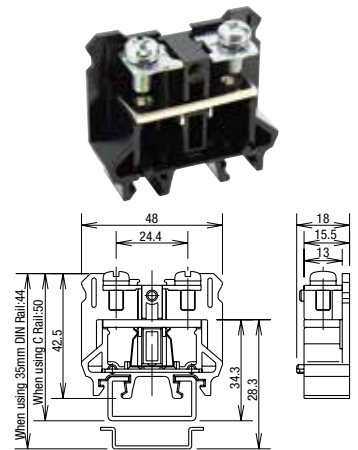
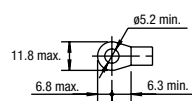
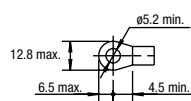
		BN40W 50A M5			BN50W 70A M5		
		Self-Lifting Terminal					
Standard	Dimensions						
	Ordering No.	BN40WPN20			BN50WPN20		
	Package Quantity	20			20		
	Weight (Approx.)	25g			25.4g		
		BNH40W 50A M5			BNH50W 70A M5		
		Touch-Down Terminal					
Standard	Dimensions						
	Ordering No.	BNH40WPN20			BNH50WPN20		
	Package Quantity	20			20		
	Weight (Approx.)	25g			29g		
Standards		UL/CSA	EN	JIS	UL/CSA	EN	JIS
Specification / Ratings	Insulation Voltage	600V	660V	630V	600V	660V	800V
	Wire Size *1	16-8 AWG	8 mm ² (16-8 AWG)	8 mm ²	16-6 AWG	14 mm ² (16-6 AWG)	14 mm ²
	Rated Current *2	40A	50A	50A	60A	67A	70A
	Terminal screw	M5			M5		
	Crimping Terminal	1.25-5 to 8-5			1.25-5 to 14-5		
	Max. No. of Crimping Terminals	2			2		
	Tightening Torque	2.6 to 3.7 N·m			2.6 to 3.7 N·m		
Crimping Terminal Dimensions (mm) *3							
Accessories *4	End Plate	BNE40W			BNE50W		
	Dust cover	BNC330			BNC320		
	Marking Strip	PVC 1m/BNM7, Fiber glass 1m/BNM9, PVC 25m/725					
	Marking Strip Fastner	BNM3					
	DIN Rail/End Clip	Aluminum: BAA1000, Steel: BAP1000/BNL6			Aluminum: BAA1000, Steel: BAP1000/BNL8		
	C Rail/End Clip	Aluminum: BNCA1000/BNL7			Aluminum: BNCA1000/BNL8		
	DIN + C Rail/End Clip	Aluminum: BNJA1000/BNL6, BNL7			Aluminum: BNJA1000/BNL8		

*1: The wire size in () does not comply with JIS standards.



*2: The rated current differs according to operating conditions. See "Selecting Terminal Blocks by Current According to JIS Standards" on G-006.

*3: Use a CSA certified crimping terminal when using the terminal block as a CSA certified product.

*4: See G-025 for details on accessories.



BN-W / BNH-W Series Terminal Blocks

Part No.	BN75W	94A	M6	BN100W	132A	M8
	Dimensions					
Ordering No.	BN75WPN10			BN100WPN05		
Package Quantity	10			5		
Weight (Approx.)	45g			86g		

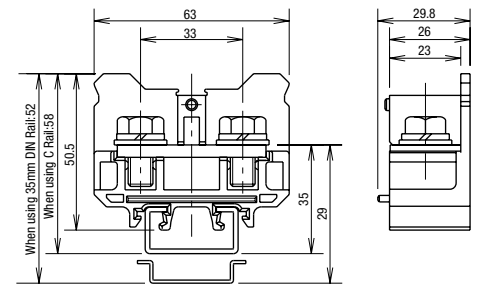
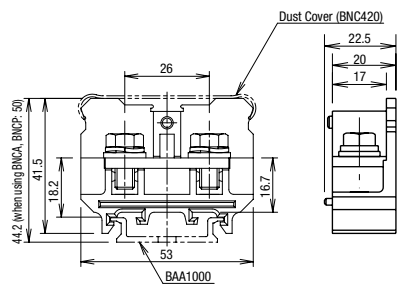

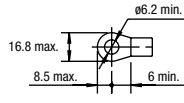
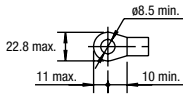
Standards	UL/CSA	EN	JIS	UL/CSA	EN	JIS
Insulation Voltage	600V	660V	1000V	600V	660V	1000V
Wire Size	16-4 AWG	22 mm ² (8-4 AWG)	22 mm ²	16-2 AWG	38 mm ² (2AWG)	38 mm ²
Rated Current *1	80A	94A	94A	100A	132A	132A
Terminal screw *2	M6			M8		
Crimping Terminal	2-6 to 22-6			2-8 to 38-8		
Max. No. of Crimping Terminals	2			2		
Socket Wrench	12.7 mm square drive hexagonal socket 10 (*4)			12.7 mm square drive hexagonal socket 13 (*2)		
Tightening Torque	3.9 to 5.4 N·m			10 to 13.5 N·m		
Crimping Terminal Dimensions (mm) *3						
Accessories *5	End Plate	BNE75W		BNE100W		
	Dust Cover	BNC420		BNC520		
	Marking Strip	PVC 1m/BNM7, Fiber glass 1m/BNM9, PVC 25m/BNM725				
	Marking Strip Fastner	BNM3				
	DIN Rail/End Clip	Aluminum: BAA1000, Steel: BAP1000/BNL8				
	Type C Rail/End Clip	Aluminum: BNCA1000/BNL8				
	DIN+Type C Rail/End Clip	Aluminum: BNJA1000/BNL8				

- *1: The rated current differs according to operating conditions. See "Selecting Terminal Blocks by Current According to JIS Standards" on G-006.
- *2: The grooves on the head of the hex bolt are for temporary tightening. For proper tightening, use an applicable socket wrench and tighten within the range of the recommended tightening torque.
- *3: Use a CSA certified crimping terminal when using the terminal block as a CSA certified product.
- *4: Applicable wrench or screwdriver can be used to tighten screws.
- *5: See G-025 for details on accessories.

Part No.		BN150W 175A M8			BN150NW 175A M8		
Large Capacity Screw Terminal	Dimensions						
	Ordering No.	BN150WPN05			BN150NWP05		
	Packaging Quantity	5			5		
	Weight (Approx.)	88g			95g		
Standards	UL/CSA	EN	JIS	—	—	JIS	
Specification / Ratings	Insulation Voltage	600V	660V	1000V	—	—	630V
	Wire Size	16-1/0 AWG	60 mm ² (1/0 AWG)	60 mm ²	—	—	60 mm ²
	Rated Current *1	150A	175A	175A	—	—	175A
	Terminal screw *2	M8			M8		
	Crimping Terminal	2-8 to 60-8			2-8 to 60-8		
	Max. No. of Crimping Terminals	2			2		
	Socket Wrench	12.7 mm square drive hexagonal socket 13 (*4)			12.7 mm square drive hexagonal socket 13 (*2)		
	Tightening Torque	10 to 13.5 N·m			10 to 13.5 N·m		
Crimping Terminal Dimensions (mm) *3							
Accessories *5	End Plate	BNE150W					
	Dust Cover	BNC520					
	Marking Strip	PVC 1m/BNM7, Fiber glass 1m/BNM9 PVC 25m/BNM725		PVC 1m/BNM7, Fiber glass 1m/BNM9 PVC 25m/BNM725			
	Marking Strip Fastner	BNM3					
	DIN Rail/End Clip	Aluminum BAA1000, Steel: BAP1000/BNL8					
	Type C Rail/End Clip	Aluminum: BNCA1000/BNL8					
	DIN+Type C Rail/End Clip	Aluminum: BNJA1000/BNL8					

*1: The rated current differs according to operating conditions. See "Selecting Terminal Blocks by Current According to JIS Standards" on G-006.
 *2: The grooves on the head of the hex bolt are for temporary tightening. For proper tightening, use an applicable socket wrench and tighten within the range of the recommended tightening torque.
 *3: Use a CSA certified crimping terminal when using the terminal block as a CSA certified product.
 *4: Applicable wrench or screwdriver can be used for tightening screws.
 *5: See G-025 for details on accessories.

BN-W / BNH-W Series Terminal Blocks

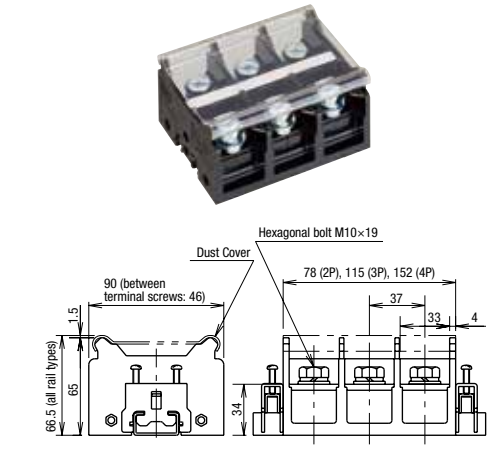
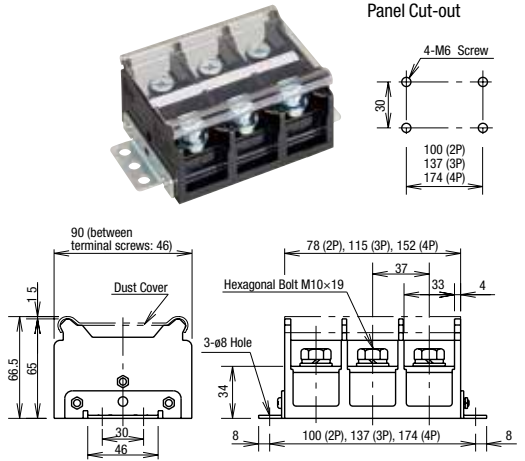
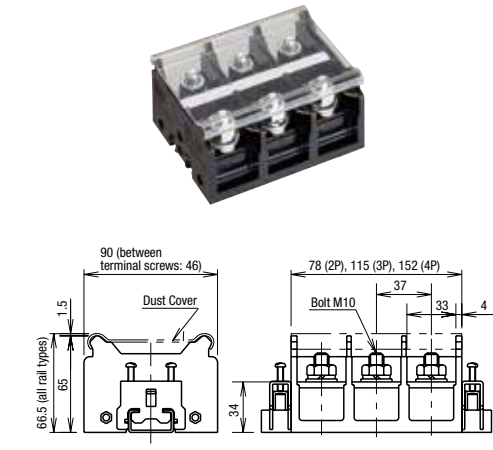
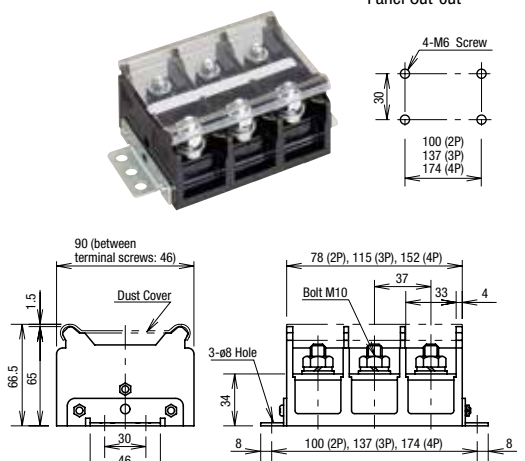
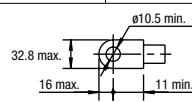
Terminal Type	Part No.	BN200BW□	240A	M10	BN200BW□K	240A	M10	Surface Mount
	Screw Terminal	Dimensions						
Package Quantity		1			1			
Weight (Approx.)		2P: 430g, 3P: 650g, 4P: 870g			2P: 490g, 3P: 710g, 4P: 930g			
Stud Terminal	Part No.	BN200NW□	240A	M10	BN200NW□K	240A	M10	Surface Mount
	Dimensions							
	Package Quantity	1			1			
Weight (Approx.)	2P: 500g, 3P: 720g, 4P: 940g			2P: 560g, 3P: 780g, 4P: 1000g				
Specification / Ratings	Standards	UL/CSA	EN	JIS	UL/CSA	EN	JIS	
	Insulation Voltage	600V	660V	800V	600V	660V	800V	
	Wire Size	4/0 AWG	100 mm ² (4/0 AWG)	100 mm ²	4/0 AWG	100 mm ² (4/0 AWG)	100 mm ²	
	Rated Current *1	200A	240A	240A	200A	240A	240A	
	Terminal Screw *2	M10			M10			
	Crimping Terminal	5.5-10 to 100-10			5.5-10 to 100-10			
	Max. No. of Crimping Terminals	2			2			
	Socket Wrench	12.7 mm square drive hexagonal socket 17 (*2)			12.7 mm square drive hexagonal socket 17 (*2)			
Tightening Torque	21 to 28 N·m			21 to 28 N·m				
Crimping Terminal Dimensions (mm) *3								
Accessories (Supplied)	End Plate, Dust Cover, Marking Strip are supplied. (Note) Marking Strip Fastener (BNM3) is not necessary.							
Accessories *4	DIN Rail	Aluminum: BAA1000, Steel: BAP1000			—			
	C Rail	Aluminum: BNCA1000			—			
	DIN+C Rail	Aluminum: BNJA1000			—			
	End Clip	BNL8			—			

*1: The rated current differs according to operating conditions. See "Selecting Terminal Blocks by Current According to JIS Standards" on G-006.
 *2: The grooves on the head of the hex bolt are for temporary tightening. For proper tightening, use an applicable socket wrench and tighten within the range of the recommended tightening torque.
 *3: Use a CSA certified crimping terminal when using the terminal block as a CSA certified product.
 *4: See G-025 for details on accessories.
 Specify the number of poles in place of □. 2-pole: 2, 3-pole: 3, 4-pole: 4.

Large Capacity	Screw Terminal	Part no.	BN300BW□	310A	M10	BN300BW□K	310A	M10	Surface Mount
		Dimensions							
	Package Quantity	1			1				
	Weight (Approx.)	2P: 480g, 3P: 750g, 4P: 1020g			2P: 540g, 3P: 810g, 4P: 1080g				
Stud Terminal	Screw Terminal	Part no.	BN300NW□	310A	M10	BN300NW□K	310A	M10	Surface Mount
		Dimensions							
	Package Quantity	1			1				
	Weight (Approx.)	2P: 540g, 3P: 810g, 4P: 1080g			2P: 600g, 3P: 870g, 4P: 1140g				
Specification / Ratings	Standards	UL/CSA	EN	JIS	UL/CSA	EN	JIS		
	Insulation Voltage	600V	660V	800V	600V	660V	800V		
	Wire Size	300 MCM	150 mm ² (300 MCM)	150 mm ²	300 MCM	150 mm ² (300 MCM)	150 mm ²		
	Rated Current *1	310A	310A	310A	310A	310A	310A		
	Terminal Screw *2	M10			M10				
	Crimping Terminal	5.5-10 to 150-10			5.5-10 to 150-10				
	Max. No. of Crimping Terminals	2			2				
	Socket Wrench	12.7 mm square drive hexagonal socket 17 (*2)			12.7 mm square drive hexagonal socket 17 (*2)				
Tightening Torque	21 to 28 N-m			21 to 28 N-m					
Crimping Terminal Dimensions (mm) *3									
Accessories (Supplied)	End Plate, Dust Cover, Marking Strip are supplied. (Note) Marking Strip Fastener (BNM3) is not necessary.								
Accessories *4	DIN Rail	Aluminum: BAA1000, Steel: BAP1000			—				
	C Rail	Aluminum: BNCA1000			—				
	DIN+C Rail	Aluminum: BNJA1000			—				
	End Clip	BNL8			—				

*1: The rated current differs according to operating conditions. See "Selecting Terminal Blocks by Current According to JIS Standards" on G-006.
 *2: The grooves on the head of the hex bolt are for temporary tightening. For proper tightening, use an applicable socket wrench and tighten within the range of the recommended tightening torque.
 *3: Use a CSA certified crimping terminal when using the terminal block as a CSA certified product.
 *4: See G-025 for details on accessories.
 Specify the number of poles in place of □. 2-pole: 2, 3-pole: 3, 4-pole: 4.

- APEM
- Switches & Pilot Lights
- Control Boxes
- Emergency Stop Switches
- Enabling Switches
- Safety Products
- Explosion Proof
- Terminal Blocks
- Relays & Sockets
- Circuit Protectors
- Power Supplies
- LED Illumination
- Controllers
- Operator Interfaces
- Sensors
- AUTO-ID

BN-W / BNH-W Series Terminal Blocks









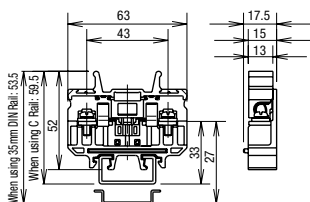

Terminal Type	Part no.	BN400BW□ 370A M12	BN400BW□K 370A M12 Surface Mount				
	Screw Terminal	Dimensions					
Package Quantity		1	1				
Weight (Approx.)		2P: 950g, 3P: 1400g, 4P: 1860g	2P: 1030g, 3P: 1480g, 4P: 1940g				
Stud Terminal	Part No.	BN400NW□ 370A M12	BN400NW□K 370A M12 Surface Mount				
	Dimensions						
	Package Quantity	1	1				
Weight (Approx.)	2P: 980g, 3P: 1460g, 4P: 1930g	2P: 1060g, 3P: 1540g, 4P: 1990g					
Specification / Ratings	Standards	UL/CSA	EN	JIS	UL/CSA	EN	JIS
	Insulation Voltage	600V	660V	800V	600V	660V	800V
	Wire Size	400 MCM	200 mm ² (400 MCM)	200 mm ²	400 MCM	200 mm ² (400 MCM)	200 mm ²
	Rated Current *1	350A	370A	370A	350A	370A	370A
	Terminal Screw *2	M12			M12		
	Crimping Terminal	14-12 to 200-12			14-12 to 200-12		
	Max. No. of Crimping Terminals	2			2		
	Socket Wrench	12.7 mm square drive hexagonal socket 19 (*2)			12.7 mm square drive hexagonal socket 19 (*2)		
Tightening Torque	38 to 49 N·m			38 to 49 N·m			
Crimping Terminal Dimensions (mm) *3							
Accessories (Supplied)	End Plate, Dust Cover, Marking Strip are supplied. (Note) Marking Strip Fastener (BNM3) is not necessary.						
Accessories *4	DIN Rail	Aluminum: BAA1000, Steel: BAP1000			—		
	C Rail	Aluminum: BNCA1000			—		
	DIN+C Rail	Aluminum: BNJA1000			—		
	End Clip	BNL8			—		

*1: The rated current differs according to operating conditions. See "Selecting Terminal Blocks by Current According to JIS Standards" on G-006.
 *2: The grooves on the head of the hex bolt are for temporary tightening. For proper tightening, use an applicable socket wrench and tighten within the range of the recommended tightening torque.
 *3: Use a CSA certified crimping terminal when using the terminal block as a CSA certified product.
 *4: See G-025 for details on accessories.
 Specify the number of poles in place of □. 2-pole: 2, 3-pole: 3, 4-pole: 4.

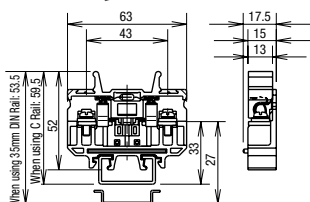
Large Capacity Surface Mount	Screw Terminal	Part No	BN500BW□K	430A	M16	Surface Mount	—			
		Dimensions			—					
		Package Quantity	1		—					
	Weight (Approx.)	2P: 1550g, 3P: 2250g, 4P: 2950g		—						
	Stud Terminal	Part No.	BN500NW□K	430A	M16	Surface Mount	BN600NW□K	520A	M16	Surface Mount
		Dimensions								
		Package Quantity	1		1					
	Weight (Approx.)	2P: 1600g, 3P: 2300g, 4P: 3000g		2P: 1650g, 3P: 2400g, 4P: 3150g						
	Specification / Ratings	Standards	UL/CSA	EN	JIS	UL/CSA	EN	JIS		
		Insulation Voltage	600V	660V	800V	600V	660V	800V		
Wire Size		500 MCM	240 mm ² (500 MCM)	250 mm ²	600 MCM	300 mm ² (600 MCM)	325 mm ²			
Rated Current *1		500A	430A	430A	600A	520A	520A			
Terminal Screw *2		M16			M16					
Crimping Terminal		14-16 to 200-16		325-16	14-16 to 200-16		325-16			
Max. No. of Crimping Terminals		2		1	2		1			
Socket Wrench		12.7 mm square drive hexagonal socket 24 (*2)			12.7 mm square drive hexagonal socket 24 (*2)					
Tightening Torque	83 to 116 N·m			83 to 116 N·m						
Crimping Terminal Dimensions (mm) *3										
Accessories (Supplied) *4	End Plate, Dust Cover, Marking Strip are supplied. (Note) Marking Strip Fastener (BNM3) is not necessary.									

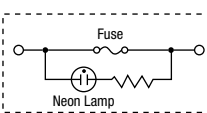
*1: The rated current differs according to operating conditions. See "Selecting Terminal Blocks by Current According to JIS Standards" on G-006.
 *2: The grooves on the head of the hex bolt are for temporary tightening. For proper tightening, use an applicable socket wrench and tighten within the range of the recommended tightening torque.
 *3: Use a CSA certified crimping terminal when using the terminal block as a CSA certified product.
 *4: See G-025 for details on accessories.
 Specify the number of poles in place of □. 2-pole: 2, 3-pole: 3, 4-pole: 4.

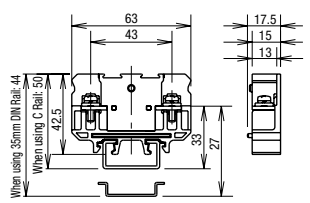
BN-W / BNH-W Series Terminal Blocks

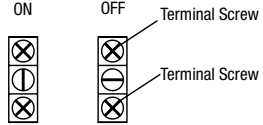
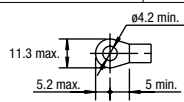
	BNF10S-□A 10A M4	BNF10N-□A (With Lamp) 10A M4	BNT20 20A M4
Self-Lifting Terminal with Fuse	    <p>Fuse Ratings</p> <ul style="list-style-type: none"> Rated Voltage: 250V Rated Current: 1, 3, 5A Cartridge Fuse: JIS C 6575-2 6.35×31.8 mm or 6.40×30.0 mm <p>• Part No.: BNF10S-1A BNF10S-3A BNF10S-5A</p> <ul style="list-style-type: none"> Cartridge used: FGB1 by FUJII Terminal Industry Co., Ltd. <p>Notes: UL/CSA approved products shown below are not supplied with fuses. When UL/CSA approval is required for fuse terminal blocks, use UL/CSA-rated fuses.</p> <ul style="list-style-type: none"> Part No.: BNF10SW Rated Insulation Voltage: 600V Rated Current: 10A Applicable Wire: 18-10 AWG UL File No.: E78117 CSA File No.: LR64803 	    <p>• Internal Connection</p>  <p>Notes: Neon lamp turns on when the fuse blows. For the neon lamp to turn on, the voltages must be from 100 to 250V AC.</p> <p>Fuse Ratings</p> <ul style="list-style-type: none"> Rated Voltage: 250V Rated Current: 1, 3, 5A Cartridge Fuse: JIS C 6575-2 6.35×31.8mm or 6.40×30.0mm <p>• Part No.: BNF10N-1A BNF10N-3A BNF10N-5A</p> <p>Note: 6.4×30.0mm fuse can also be used.</p>	    <p>Notes:</p> <ul style="list-style-type: none"> Rated Current: 20A This terminal block cannot be used as a disconnect switch. When switching on/off, make sure that voltage is not applied. <p>ON OFF Terminal Screw</p> 
	Self-Lifting Terminal with Disconnecting Switch		
Ordering No.	BNF10S-□APN20	BNF10N-□APN20	BNT20PN20
Package Quantity	20	20	20
Weight (Approx.)	34g	34g	36g
Standards	JIS	JIS	JIS
Specification / Ratings	Insulation Voltage	600V	600V
	Wire Size	5.5 mm ²	5.5 mm ²
	Rated Current	10A max.	20A
	Terminal Screw	M4	M4
	Crimping Terminal	1.25-4 to 5.5-4	1.25-4 to 5.5-4
	Max. No. of Crimping Terminals	2	2
Tightening Torque	1.4 to 2.0 N·m	1.4 to 2.0 N·m	1.4 to 2.0 N·m
Crimping Terminal Dimensions (mm)			
Accessories *1	End Plate	BNE20	
	Dust Cover	—	BNC520
	Marking Strip	—	PVC 1m/BNM7, Fiber glass 1m/BNM9 PVC 25m/BNM725
	DIN Rail/End Clip	Aluminum: BAA1000, Steel: BAP1000 /BNL6	
	C Rail/End Clip	Aluminum: BNCA1000/BNL7	
DIN+C Rail/End Clip	Aluminum: BNJA1000 /BNL6, BNL7		

*1: See G-025 for details on accessories.

		Self-Lifting Terminal			Touch-Down Terminal		
		Part No.	BND15W 16A M3	BND15LW 21A M3.5	Part No.	BNDH15W 16A M3	BNDH15LW 21A M3.5
Double-Deck Terminal Block	Self-Lifting Terminal	Dimensions					
		Ordering No.	BND15WPN25		BND15LWPN25		
	Package Quantity	25		25			
	Weight (Approx.)	16g		23g			
Touch-Down Terminal	Touch-Down Terminal	Dimensions					
		Ordering No.	BNDH15WPN25		BNDH15LWPN25		
	Package Quantity	25		25			
	Weight (Approx.)	17g		26g			
Standards		UL/CSA	EN	JIS	UL/CSA	EN	JIS
Specification / Ratings	Insulation Voltage	600V	660V	800V	600V	660V	800V
	Wire Size	22-14 AWG	2 mm ² (22-14 AWG)	1.25 mm ² (2 mm ² max)	22-14 AWG	2 mm ² (22-14 AWG)	2 mm ²
	Rated Current *1	10A	22A	16A	15A	22A	21A
	Terminal Screw *2	M3			M3.5		
	Crimping Terminal	1.25-3 (2-3)			2-3.5		
	Max. No. of Crimping Terminals	2			2		
	Tightening Torque	0.6 to 1 N·m			1 to 1.3 N·m		
Crimping Terminal (mm) *3							
Accessories *4	End Plate	BNDE15W/BNDE15W2			BNDE15LW/BNDE15LW2		
	Dust Cover	Upper Deck: BNC230, Lower Deck: BNC240					
	Marking Strip	PVC 1m/BNM7, Fiber glass 1m/BNM9, PVC 25m/BNM725					
	Marking Strip Fastener	BNM3					
	Surface Mounting Clip	BNDL2					
	Connecting Rod/Connecting Nut	Connecting Rod: BNR1, BNR2, Connecting Nut: BNN1					
	DIN Rail/End Clip	Aluminum: BAA1000, Steel: BAP1000/BNL6					
	C Rail/End Clip	Aluminum: BNCA1000/BNL7					
DIN+C Rail/End Clip	Aluminum: BNJA1000/BNL6, BNL7						

*1: The rated current differs according to operating conditions. See "Selecting Terminal Blocks by Current According to JIS Standards" on G-006.

*2: The grooves on the head of the hex bolt are for temporary tightening. For proper tightening, use an applicable socket wrench and tighten within the range of the recommended tightening torque.



*3: Use a CSA certified crimping terminal when using the terminal block as a CSA certified product.

*4: See G-025 for details on accessories.

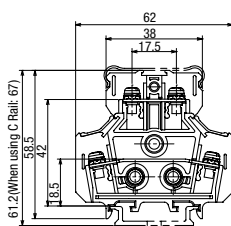
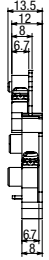

Download catalogs and CAD from <http://eu.idec.com/downloads>

BN-W / BNH-W Series Terminal Blocks

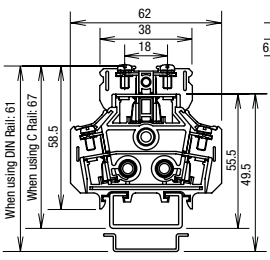
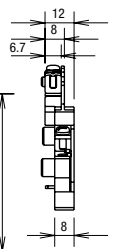
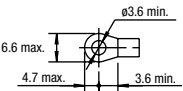
		Part No.	BND15WT	21A	M3.5	
Self-Lifting Terminal	Dimensions	  				
		Ordering No.	BND15WTPN25			
		Package Quantity	25			
		Weight (Approx.)	17g			
Touch-Down Terminal	Dimensions	  				
		Ordering No.	BNDH15WTPN25			
		Package Quantity	25			
		Weight (Approx.)	17g			
Standards		UL/CSA	EN	JIS		
Specification / Ratings	Insulation Voltage	600V	660V	800V		
	Wire Size	22-14 AWG	2mm ² (22-14 AWG)	2 mm ²		
	Rated Current *1	15A	22A	21A		
	Terminal Screw	M3				
	Crimping Terminal	1.25-3.5 to 2-3.5				
	Max. No. of Crimping Terminals	2				
	Tightening Torque	1.0 to 1.3 N·m				
Crimping Terminal (mm) *2						
Accessories *3	End Plate	BNDE15W/BNDE15W2				
	Dust Cover	Upper Deck: BNC230, Lower Deck: BNC240				
	Marking Strip	PVC 1m/BNM7, Fiber glass 1m/BNM9, PVC 25m/BNM725				
	Marking Strip Fastener	BNM3				
	Surface Mounting Clip	BNDL2				
	Connecting Rod/ Connecting Nut	Connecting Rod: BNR1, BNR2, Connecting Nut: BNN				
	DIN Rail/End Clip	Aluminum: BAA1000, Steel: BAP1000/BNL6				
	C Rail/End Clip	Aluminum: BNCA1000/BNL7				
DIN+C Rail/End Clip	Aluminum: BNJA1000/BNL6, BNL7					

*1: The rated current differs according to operating conditions. See "Selecting Terminal Blocks by Current According to JIS Standards" on G-006.

*2: Use a CSA certified crimping terminal when using the terminal block as a CSA certified product.

*3: See G-025 for details on accessories.

Common Terminal Self-Lifting Terminal	Part No.	BN15MC4	16A (common current)	M3	BN15MC8	16A (common current)	M3	BN15MC10	16A (common current)	M3
	No. of Poles	4			8			10		
	Shape									
	Dimensions									
	Ordering No.	BN15MC4PN10			BN15MC8PN10			BN15MC10PN10		
	Package Quantity	10			10			10		
Weight (Approx.)	30g			57g			70g			
Color	Light Gray			Light Gray			Light Gray			

Standards		JIS
Specification / Ratings	Insulation Voltage	600V
	Wire Size	1.25 mm ² (2 mm ² max.)
	Rated Current	16A/Common Current
	Terminal Screw	M3
	Crimping Terminal	1.25-3 (2-3)
	Max. No. of Crimping Terminals	2
	Tightening Torque	0.6-1.0 N·m
Crimping Terminal Dimensions (mm)		
Accessories #5	End Plate	Supplied
	Dust Cover	BNC230
	Marking Strip	PVC 1m/BNM7, Fiber glass 1m/BNM9, PVC 25m/BNM725
	Marking Strip Fastener	BNM3
	DIN Rail / End Clip	Aluminum: BAA1000, Steel: BAP1000/BNL6
	C Rail / End Clip	Aluminum: BNCA1000/BNL7
DIN+C Rail / End Clip	Aluminum: BNJA1000/BNL6, BNL7	

- *1: The rated applicable wire size is 1.25 mm², but 2 mm² wires can also be connected. The wire size in () does not comply with JIS standards.
- *2: Do not remove the built-in common jumper. Common terminal type terminal blocks cannot be disassembled.
- *3: Make sure that all terminal screws are tightened to an appropriate tightening torque before power is applied.
- *4: Specifications are in compliance with JIS C 8201-7-1 except values in ().
- *5: See G-025 for details on accessories.

Application Example

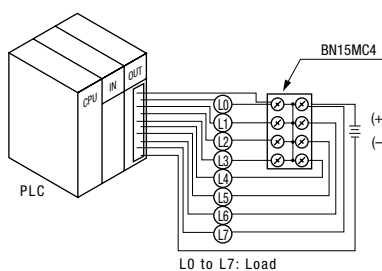

Features

- All terminals are short-circuited by a built-in common jumper. External jumpers are not required.
- Accessories (marking strip, cover, and rails) are compatible with standard types.
- Common terminal type terminal blocks can be combined with other standard types as they are identical in shape and in size as BN15MW.
- Color: Light Gray

Accessories (End Plate / Rail)

End Plates

Used for ends of terminal blocks. Also used to hold the marking strips in place.

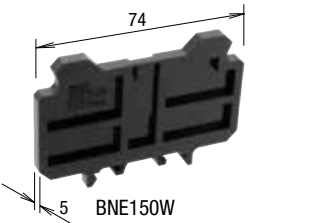
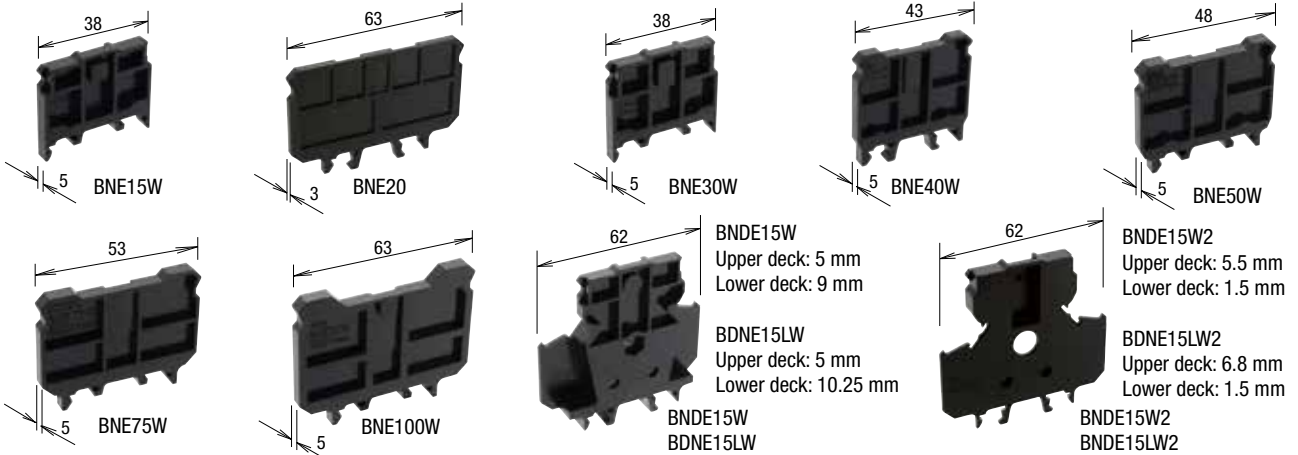

Securing a marking strip with the end plate

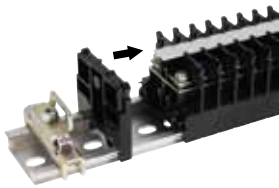

	Part No.	Ordering No.	Applicable Terminal Blocks	Thickness (mm)	Weight (Approx.)	Package Quantity
End Plate	BNE15W	BNE15WPN10	BN10W, BNH10W BN15MW, BNH15MW BN15LW, BNH15LW BN15MWT, BNH15MWT BN15LWT, BNH15LWT	5.0	4g	10
	BNE20	BNE20PN10	BNT20, BNF10S, BNF10N	3.0	8g	
	BNE30W	BNE30WPN10	BN30W, BNH30W	5.0	4g	
	BNE40W	BNE40WPN10	BN40W, BNH40W	5.0	5g	
	BNE50W	BNE50WPN10	BN50W, BNH50W	5.0	6g	
	BNE75W	BNE75WPN10	BN75W	5.0	6g	
	BNE100W	BNE100WPN10	BN100W	5.0	9g	
	BNE150W	BNE150WPN10	BN150W, BN150NW	5.0	10g	
	BNDE15W	BNDE15WPN10	BND15W, BND15WT, BNDH15W, BNDH15WT	Upper deck: 5.0 Lower deck: 9.0	5.5g	
	BNDE15LW	BNDE15LWPN10	BND15LW, BNDH15LW	Upper deck: 5.0 Lower deck: 10.25	6g	
End Plate for Securing End Plate	BNDE15W2	BNDE15W2PN10	BND15W, BND15WT, BNDH15W, BNDH15WT	Upper deck: 5.5 Lower deck: 1.5	5.5g	
	BNDE15LW2	BNDE15LW2PN10	BND15LW, BNDH15LW	Upper deck: 6.8 Lower deck: 1.5	6g	

Note: BNDE15W2 and BNDE15LW2 are end plates used for securing marking strips at the end of double deck terminal blocks.

Rails

Rails for mounting terminal blocks. Available in four styles.

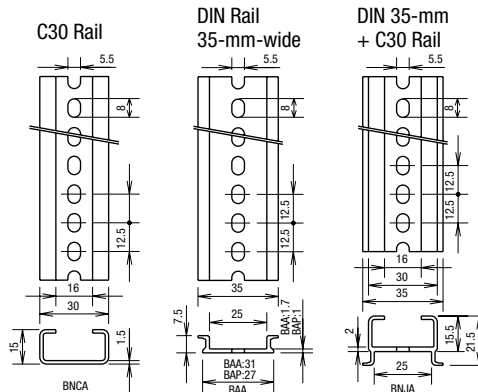
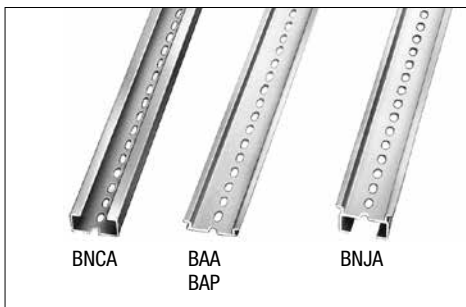

Approvals:
IEC60715
JIS C 2812

Length	Part No.	Ordering No.	Material	Weight (Approx.)	Package Quantity
1000 mm	BNCA1000	BNCA1000PN10	Aluminum	260g	10
	BAA1000	BAA1000PN10	Aluminum	200g	10
	BAP1000	BAP1000PN10	Steel	320g	10
	BNJA1000	BNJA1000PN10	Aluminum	340g	10

Accessories (End Clip / Rail Mounting Clip / Dust Cover)

End Clips

Used to secure the ends of the terminal blocks assembled on the rail.

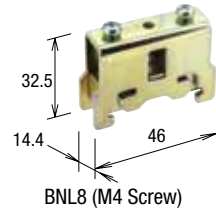

- Material: Steel
- Plating: Trivalent zinc chromate

Note: Slide the end clip onto the DIN rail.

Part No.	Ordering No.	Rails	For Terminal Blocks up to BND and BN□40	For BN□50 and BN□75	For Terminal Blocks BN□100 and larger	Weight (Approx.)	Package Quantity
BNL6	BNL6PN10	BAA, BAP	×	× (*2)	—	15.2g	10
BNL7	BNL7PN10	BNCA, BNCP, BNJA	×	× (*2)	—	16g	10
BNL8	BNL8PN10	BAA, BAP, BNCA, BNCP, BNJA	— (*1)	×	×	56g	10

- *1: Do not use BNL8 because the insulation distance will be insufficient if used.
- *2: We recommend you to use BNL8 for secure hold.

Rail Mounting Clips

Used to raise the DIN rail from the panel surface.

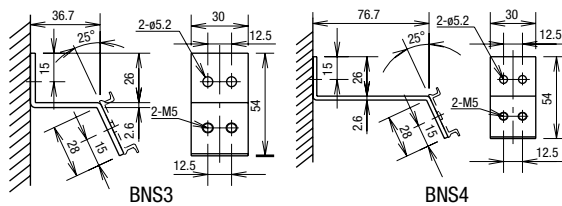

Part No.	Ordering No.	Weight (Approx.)	Package Quantity
BNS3	BNS3PN10	51.3g	10
BNS4	BNS4PN10	76.2g	10

- Material: Steel
- Plating: Trivalent zinc chromate

Dust Cover

Material: Polycarbonate

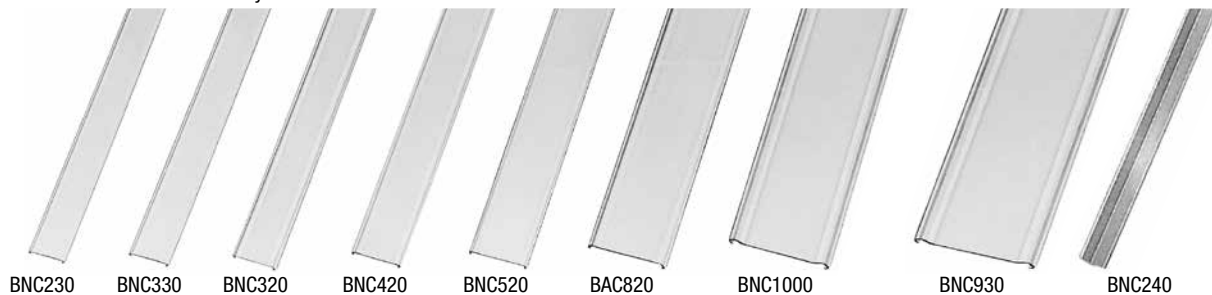

Length	Width (mm)	Part No.	Ordering No.	Terminal Blocks (□: No. of Poles)	Weight (Approx.)	Package Quantity
1m	39.6	BNC230	BNC230PN10	BN10W, BNH10W, BN15MW, BNH15MW, BN15LW, BNH15LW, BN30W, BNH30W, BN15MWT, BNH15MWT, BN15LWT, BNH15LWT	56g	10
	43	BNC330	BNC330PN10	BN40W, BNH40W	57g	10
	49.6	BNC320	BNC320PN10	BN50W, BNH50W	64g	10
	54.6	BNC420	BNC420PN10	BN75W	72g	10
	65	BNC520	BNC520PN10	BN150W, BN150NW, BNT20, BN100W	96g	10
	82	BAC820	BAC820PN10	BN200BW□(K), BN200NW□(K)	204g	10
	96	BNC910	BNC910PN10	BN300BW□(K), BN300NW□(K)	222g	10
	110	BNC1000	BNC1000PN10	BN400BW□(K), BN400NW□(K)	256g	10
	145	BNC930	BNC930PN10	BN500BW□(K), BN500NW□(K), BN600NW□(K)	310g	10

Dust Covers for Double Deck Terminal Blocks

Length	Part No.	Ordering No.	Terminal Block	Weight (Approx.)	Package Quantity
1m	Upper Deck BNC230	BNC230PN10	BND15W, BNDH15W, BND15LW, BNDH15LW, BND15WT, BNDH15WT	56g	10
	Lower Deck BNC240	BNC240PN10		15g	10

Accessories (Marking Strips / Marking Strip Fastener / Slide Marking Strip)

Marking Strips, Marking Strip Fastener

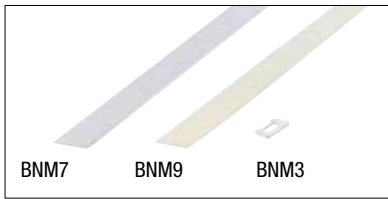

Item	Part No.	Ordering No.	Weight (approx.)	Package Quantity	Specification
Marking Strip	BNM7	BNM7PN10	7.2g	10	PVC (glossy surface) 1000 mm × 9.5 mm × 0.5 mm
	BNM9	BNM9PN10	6.4g	10	Fiber glass (matte surface) 1000 mm × 9.5 mm × 0.5 mm
	BNM725	BNM725	—	1	PVC (matte surface) 25 m × 9.5 mm × 0.5 mm
Marking Strip Fastener	BNM3	BNM3PN50	0.1g	50	

- To install the marking strip fastener

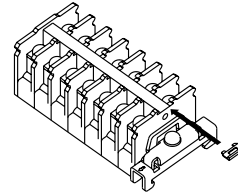
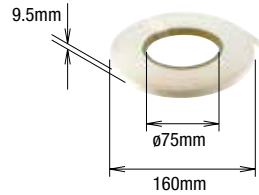

Sliding Marking Strip (BN10W to BN30W)

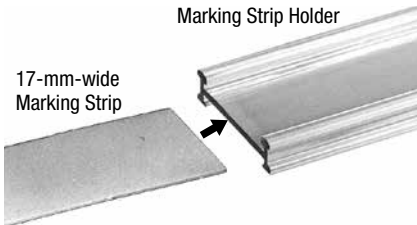

17-mm-wide marking strip

- Both top and bottom sides of the marking strip holder can be used.

End plate (Thickness 5 mm)
BNES15W
BNES30W



Terminal Block
BN10W to BN15LWT
BN30W

Item	Part No.	Ordering No.	Terminal Blocks	Specification	Package Quantity
① End Plate	BNES15W	BNES15WPN10	BN10W to BN15LWT	For sliding marking strip	10
	BNES30W	BNES30WPN10	BN30W	For sliding marking strip	10
② Marking Strip	BNM5	BNM5PN10	BN10W to BN15LWT BN30W	PVC (Note)	10
③ Marking Strip Holder	BNMH1	BNMH1PN10		1m	10
④ Dust Cover	BNCS230	BNCS230PN10		1m	10

Note: Length 1000 mm × Width 9.5 mm × Thickness 0.5 mm

Installing the Sliding Marking Strip

1. Insert the marking strip into the groove of the top of the marking strip holder.

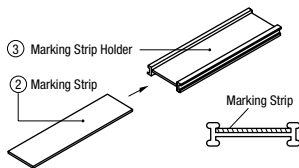

3. Insert the marking strip holder into the recess of the end plate.

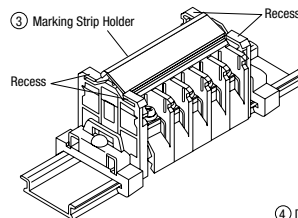

2. Installing the end plate

Attach the end plates to the terminal blocks and secure with end clips.

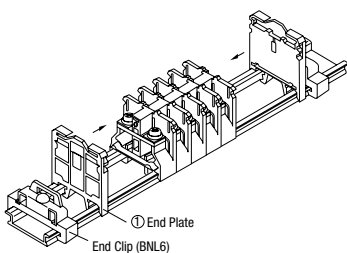

4. Press the dust cover to fit onto the bottom groove of the end plate.

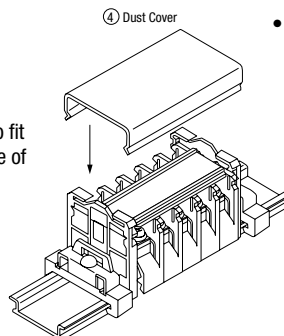

Movement

- Sliding movement of the marking strip holder

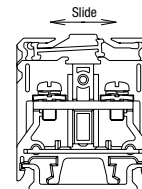

When sliding the marking strip holder, slide by holding both edges of the holder.

- To lock the marking strip holder

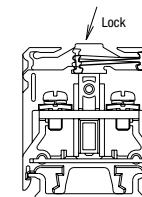

To lock the marking strip holder, lock by holding both edges of the holder.

Accessories (Jumper)

Jumpers for 6 Poles (Material: Brass, Plating: Nickel-plated, Insulation: PVC)

Part No.	Ordering No.	Terminal Centers	Insulation	Dimensions	Current (Note 1, 2)	Applicable Terminal Block	Weight (Approx.)	Package Quantity
BNJ16	BNJ16PN10	7 mm	Without	Ring Terminal 	10A	BN10W BNH10W	2.8g	10
BNJ16B	BNJ16BPN10		With	Fork Terminal 				10
BNJ16F	BNJ16FPN10		Without				2.7g	10
BNJ16FB	BNJ16FBPN10		With					10
BNJ26W	BNJ26WPN10	8 mm	Without		Ring Terminal 	20A	BN15MW BNH15MW BNH15WWT BNH15MWT BND15W BNDH15W BND15WT BNDH15WT	3.1g
BNJ26WB	BNJ26WBPN10		With	Fork Terminal 	10			
BNJ26FW	BNJ26FWPN10		Without		3.1g			10
BNJ26FWB	BNJ26FWBPN10		With					10
BNJ46	BNJ46PN10	10.5 mm	Without		Ring Terminal 	20A	BN15LW BNH15LW BNH15LWT BND15LW BNDH15LW	4.6g
BNJ46B	BNJ46BPN10		With	Fork Terminal 	10			
BNJ46F	BNJ46FPN10		Without		3.0g			10
BNJ46FB	BNJ46FBPN10		With					10
BNJ56	BNJ56PN10	12 mm	Without		Ring Terminal 	30A	BN30W BNH30W	3.2g
BNJ56B	BNJ56BPN10		With	Fork Terminal 	10			
BNJ56F	BNJ56FPN10		Without		4.5g			10
BNJ56FB	BNJ56FBPN10		With					10

• Insulation color: Black, Insulation material: PVC

Note 1: Ensure that the total current to the jumper does not exceed the maximum current.

Note 2: Ensure that the current does not exceed the rated current of the terminal block to be used.

Jumper for 2 poles

Part No.	Ordering No.	Terminal Centers	Insulation	Dimensions	Current (Note 1, 2)	Applicable Terminal Block	Package Quantity
BNJ62	BNJ62PN10	14.5 mm	Without	Ring Terminal 	80A	BN40W (Note 3) BNH40W (Note 3) BN50W BNH50W	10
BNJ62B	BNJ62BPN10		With				

• Material: nickel-coated brass

• Sheath: PVC

Note 1: Ensure that the total current to the jumper does not exceed the maximum current.

Note 2: Ensure that the current does not exceed the rated current of the terminal block to be used.

Note 3: BN40W and BNH40: Do not install adjacently.



Accessories (Removal Tool)

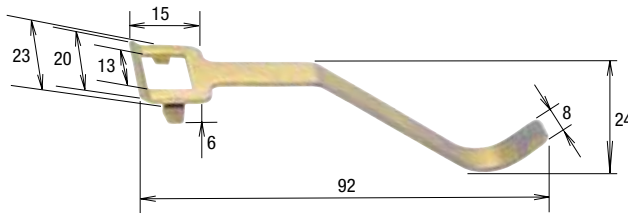

A tool for removing terminal blocks from the DIN rail.

Part No.	Weight (Approx.)	Package Quantity
BND2	8.6g	1

- Material: Steel
- Plating: Zinc

Note: Cannot be used for terminal blocks other than BN10W, BNH10W, BN15MW, BNH15MWT, BN15LW, BNH15LW, BN15LWT, BNH15LWT, BN30W, and BNH30W.

Accessories for BND Double-Deck Terminal Blocks

Surface Mounting Clip

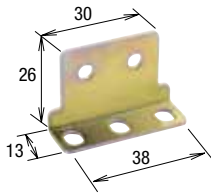

Part No.	Ordering No.	Applicable Terminal Block	Weight (Approx.)	Package Quantity
BNDL2	BNDL2PN10	BND15W, BNDH15W BND15WT, BNDH15WT BND15LW, BNDH15LW	14.3g	10

- Material: Steel
- Plating: Zinc

Connecting Rods



Part No.	Ordering No.	Applicable Terminal Block	Weight (Approx.)	Dimensions (mm)	Package Quantity
BNR1	BNR1PN10	BND15W, BNDH15W BND15WT, BNDH15WT	21g	265 mm (M4×0.7)	10
BNR2	BNR2PN10	BND15LW, BNDH15LW	43g	500 mm (M4×0.7)	10

- Material: Steel
- Plating: Zinc

Connecting Nuts

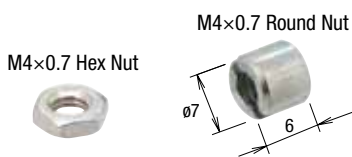

Part No.	Ordering No.	Applicable Terminal Block	Weight (Approx.)	Package Quantity
BNN1	BNN1PN1H	BND15W, BNDH15W BND15WT, BNDH15WT BND15LW, BNDH15LW	14g	100 (pairs of both nuts)

- Material: Steel
- Plating: Zinc

- APEM
- Switches & Pilot Lights
- Control Boxes
- Emergency Stop Switches
- Enabling Switches
- Safety Products
- Explosion Proof
- Terminal Blocks**
- Relays & Sockets
- Circuit Protectors
- Power Supplies
- LED Illumination
- Controllers
- Operator Interfaces
- Sensors
- AUTO-ID

Calculating Rail Lengths and Mounting Centers

- BNCA, BAA, BAP, and BNJA Rails

$$L_1 = 12.5 \times N$$

$$L_2 = L_1 - 25$$

Note: This formula is for calculating the maximum rail length including tolerance. Depending on the combination of terminal blocks, the required rail length may be shorter than the calculated value, particularly when many terminal blocks are combined.

N: Rounded up numerical number from the calculated value of M. (Example: N for 19.1 is 20)

$$M = \frac{(A + 0.1)n + B + C}{12.5}$$

- A: Thickness of each terminal block
- B: Thickness of end plate
- C: Thickness of end clip when using 2 pieces of:
 - BNL6 = 56.0 mm
 - BNL7 = 62.5 mm
 - BNL8 = 67.0 mm
- n: The number of terminal blocks

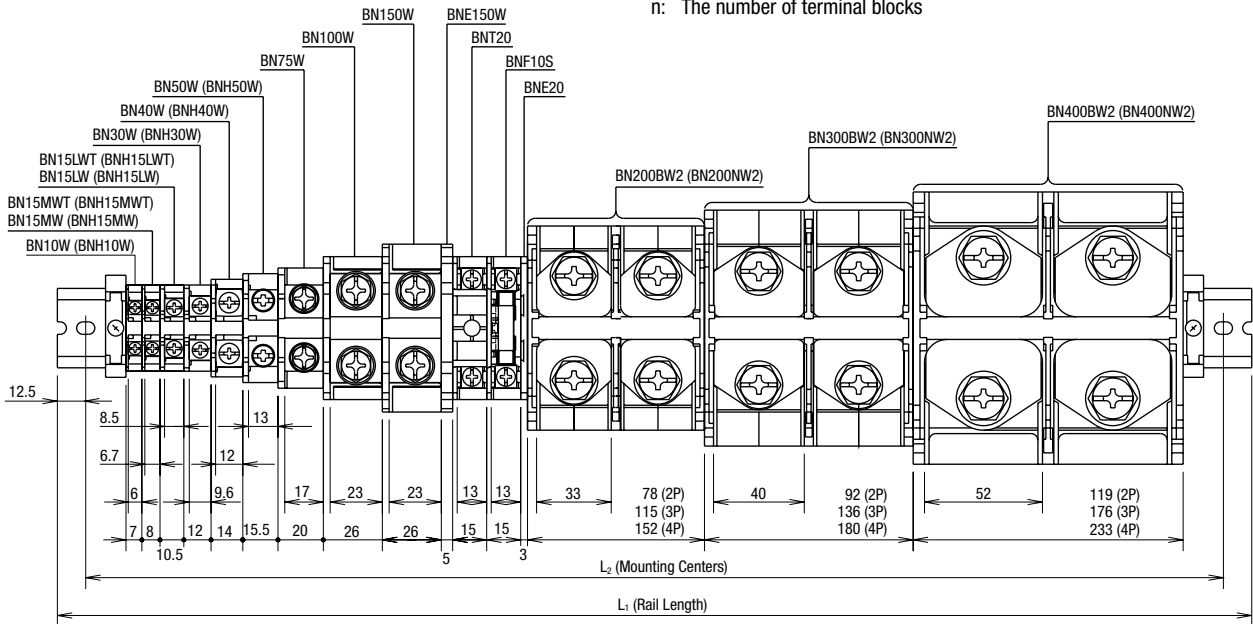

Rail Length (Double-Deck)

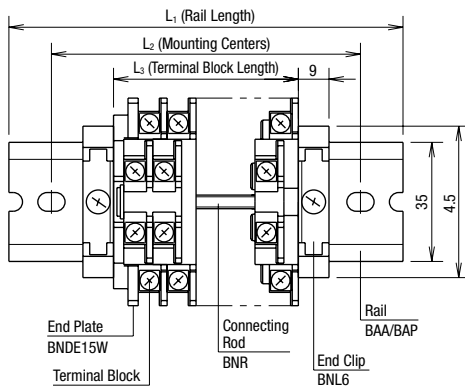

Mounting Centers (Double-Deck)

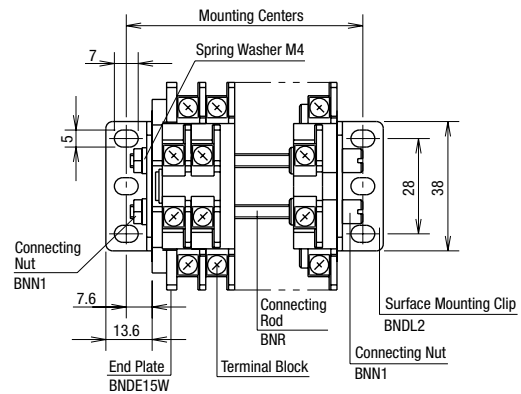

Calculating the length (mm)

Part No.	BND15W BNDH15W BND15WT	BND15LW BNDH15LW
L1 (*1)	12.5 × N	
L2 (*1)	L ₁ - 25	
L3 (*1, *2)	8 × n + 9	10.5 × n + 10.3
Connecting Rod Length (*1, *2)	8 × n + 8.7	10.5 × n + 10

N: Rounded up numerical number from the calculated value of M. (Example: N for 19.1 is 20)

For BND15W, BNDH15W, BND15WT

For BND15LW, BNDH15LW

$$M = \frac{(8 \times n + 9 + 62.5)}{12.5}$$

$$M = \frac{10.5 \times n + 10.3 + 62.5}{12.5}$$

Calculating the length (mm)

Part No.	BND15W BNDH15W BND15WT	BND15LW BNDH15LW
Mounting Centers (*1, *2)	8 × n + 24.2	10.5 × n + 25.5
Connecting Rod Length (*1, *2)	8 × n + 20.2	10.5 × n + 21.5

n: The number of terminal blocks

*1: This formula is for calculating the maximum rail length including tolerance. Depending on the combination of terminal blocks, the required rail length may be shorter than the calculated value, particularly when many terminal blocks are combined.

*2: The length will be 1.5 mm longer when end plates BNDE15W2 and BNDE15LW2 are used.

Instructions

How to Use Touch-Down Terminals



1. With the terminal screws in the up position, insert a ring crimping terminal.

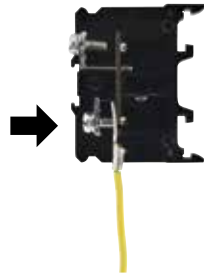

2. Push down the head of the screw lightly to hold the crimping terminal.



3. When the wiring is in position, tighten all the screws simultaneously.

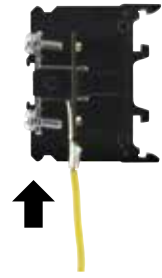

4. To remove the wiring, loosen the screw and lightly push up.

Installation and Removal on Rails

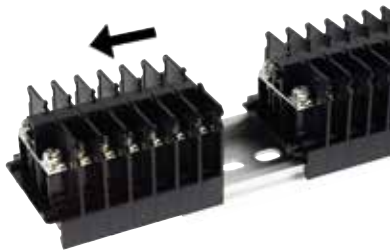

Additional Installation and Removal (on DIN Rail)

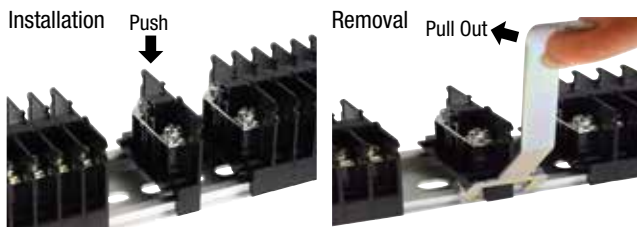

Notes: The following terminal blocks can be added or removed:
BN10W, BNH10W, BN15MW, BNH15MW, BN15LW, BNH15LW, BN30W,
BNH30W, BN15MWT, BNH15MWT, BN15LWT, BNH15LWT

Securing the Ends of the Marking Strip

The ends of the marking strip can be secured with a marking strip fastener (or end plate).

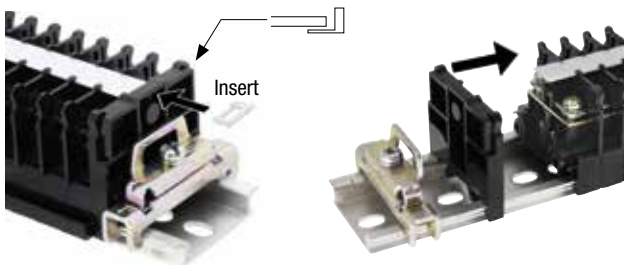

To Secure the Marking Strip

Installing End Plate

For double-deck, use an end plate to secure marking strips (BNDE15W2, BNDE15LW2).

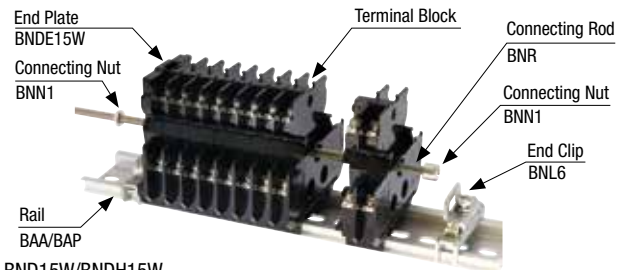
Installation of Double-Deck Terminal Blocks (BND)
Rail Mount (photo: when using BND15W, BNDH15W, BNDE15W2)

BND15W/BNDH15W

1. Install end plate. Then mount the terminal blocks onto the DIN rail.
2. Insert connecting rod (BNR) through each hole of the terminal blocks.
3. Secure the ends of the connecting rods with connecting nuts (BNN1).
4. To prevent side-to-side movement on the DIN rail, use the BNL6 end clips at both ends of the rail.

Surface Mount

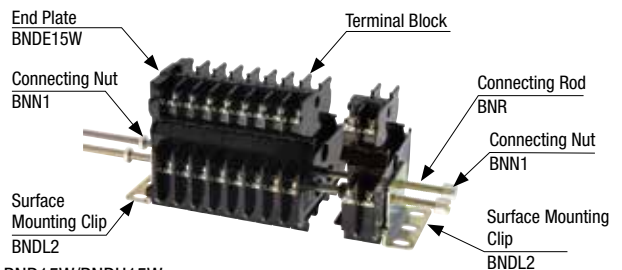

BND15W/BNDH15W

1. Assemble a row of terminal blocks with end plates on exposed ends.
2. Use BNDL2 mounting clips at both ends of a row.
3. With the two holes of the mounting clip (BNDL2) aligned with the terminal block holes, insert a connecting rod (BNR) through each hole.
4. Secure the ends of the connecting rods with the connecting nuts (BNN1).

Instructions

Dust Covers on the Lower Deck Terminal of Double-Deck Terminal Blocks

Installing Dust Covers on Lower Deck Terminals

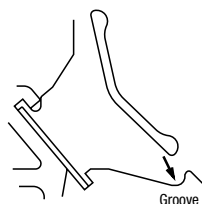
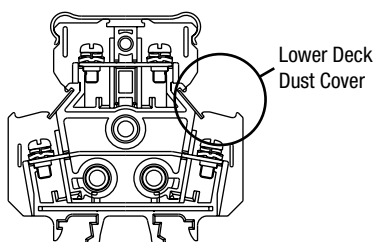

1. Press the lower end of the dust cover into the groove.

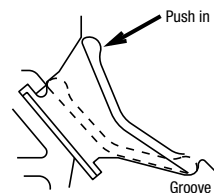

2. With the lower end of the dust cover pressed into the groove, push in the top end in the direction of the arrow.

Removing Dust Covers from Lower Deck Terminals

Turn the power off before removing the dust cover.

1. Hold the end of the dust cover which is extruding from the end plate.

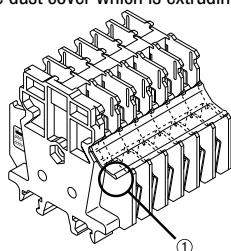

2. Lift up in the direction of the arrow.
3. If the dust cover cannot be removed all at once, place fingers between the terminal block and dust cover, and slowly remove the dust cover.

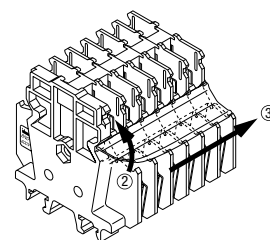

Length of Double-Deck Dust Covers

Upper-Deck Dust Cover
BNC230

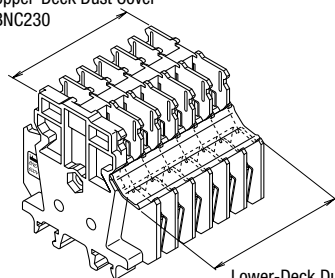

Lower-Deck Dust Cover
BNC240

Cut required length depending on the number of terminal blocks used. (Length in mm)

Terminal Block	Dust Cover	1-pole	2-pole	3-pole	4-pole	5-pole	6-pole	7-pole	8-pole	n-pole
BND(H)15W BND(H)15WT	Upper Deck	12	20	28	36	44	52	60	68	8 (n+1) - 4
	Lower Deck	16	24	32	32	48	56	64	72	8 (n+1)
BND(H)15LW	Upper Deck	16	26.5	37	47.5	58	68.5	79	89.5	10.5 (n+1) - 5
	Lower Deck	21	31.5	42	52.5	63	73.5	84	94.5	10.5 (n+1)

Securing Marking Strip with Marking Strip Fasteners for Double-Deck Terminal Blocks

Because marking strips can be secured without using marking strip fasteners, installation time can be shortened. Also, marking strips can be inserted and removed after installation.

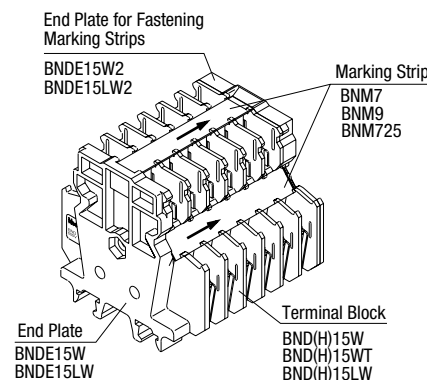
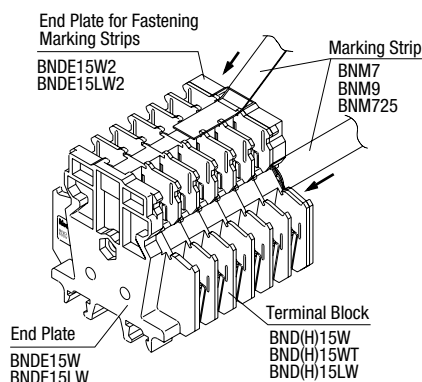

Notes on Wiring

Crimping Terminals

• When using crimping terminals, be sure to use insulated terminals to prevent electric shocks.

Without Crimping Terminals

- Insert the wire until the insulation comes into contact with the terminal metal part.
- Strip the insulation so that the wire is longer than the width of the wire clamp.
- When connecting two wires, use wires of the same size.

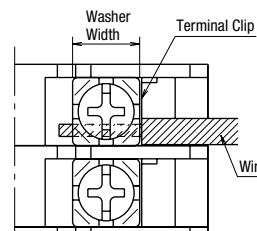

X-ON Electronics

Largest Supplier of Electrical and Electronic Components

Click to view similar products for [DIN Rail Terminal Blocks](#) category:

Click to view products by [Idec](#) manufacturer:

Other Similar products are found below :

[00110420202](#) [00175550302](#) [8WA1011-1BH23](#) [91.040](#) [9123140000](#) [RBO 5-T-B-HEX](#) [1333564](#) [1431306](#) [HSL-TB64-DIN](#) [90.070](#) [90.202](#)
[912314](#) [260-301_NR](#) [280-560](#) [280-564](#) [281-611/281-542](#) [281-673/281-411](#) [281-994](#) [283-317](#) [283-607](#) [264-724](#) [264-726](#) [280-530](#) [280-555](#)
[280-619](#) [281-610](#) [281-622/281-417](#) [284-317](#) [2907033](#) [35956](#) [USK 10](#) [102510](#) [5520682](#) [EMH 25-ZE30](#) [1SNK706410R0000](#)
[1SNK705210R0000](#) [1SNK705151R0000](#) [1SNK705020R0000](#) [1SNK506066R0000](#) [1SNK506061R0000](#) [1SNK506012R0000](#)
[1SNK505065R0000](#) [1SNK505060R0000](#) [UM 45-SEFE M.NUT BK](#) [1SNK505062R0000](#) [1SNK506013R0000](#) [1SNK506030R0000](#)
[1SNK506062R0000](#) [1SNK506065R0000](#) [1SNK508062R0000](#)