



Think Automation and beyond...



The New MicroSmart PLC Family



“The features and adaptability of MicroSmart PLCs make them my first choice for applications now and in the future!” – Project Manager

The Power to Control. Anywhere. Anytime.

Power, Performance, Connectivity

Maximize efficiency and cut development time! MicroSmart PLCs combine advanced networking capabilities with unparalleled power, performance and connectivity. Designed to meet all your communication requirements, now and in the future, MicroSmart Pentra PLCs give you the flexibility to expand your system with as many as fifteen modules! Our new Embedded Ethernet PLC with built-in Modbus TCP also lets you monitor status in real-time, receive email alerts and customize your own web page.

Safety

All MicroSmart PLCs (FC4A and FC5A) meet the highest standards for safety including: cULus listed, CE compliant, as well as certified for marine use by ABS (American Bureau of Shipping), DNV (Det Norske Veritas), GL (Germanischer Lloyd) and LR (Lloyd's Register of Shipping).*



**Note: The following products are pending approval for UL, ABS, DNV and Lloyd's Registry
FC5A-D12*, FC4A-K4A1, FC4A-PM128, FC5A-F2M2, FC5A-F2MR2, FC5A-SIF2, FC5A-SIF4, FC5A-C**R2D, FC5A-EXM*, FC4A-SX5ES*, FC4A-AS62M, and FC4A-N08A11.*



The MicroSmart Pentra PLC Family: Everything you need in a controller



Embedded Ethernet Port



Modbus TCP, RTU and ASCII



Seven communication ports



User web page



Email and text notifications



USB programming port



NEW Advanced PID modules



NEW 4-pt. analog output module

A CPU for every application

With three controller types to choose from, MicroSmart Pentra PLCs offer the features you need for your applications. Built to allow you the flexibility to expand when you need to, MicroSmart Pentra PLCs are the best way to get everything you need in just one controller.

Note: For a comparison of FC5A and FC4A functions, see CPU Highlights on pages 22 and 23.

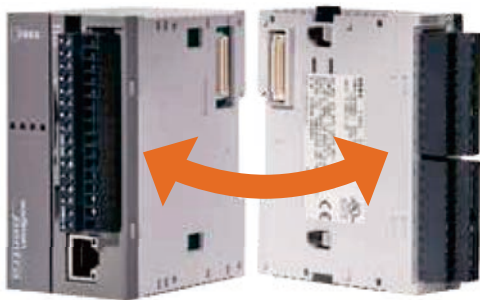
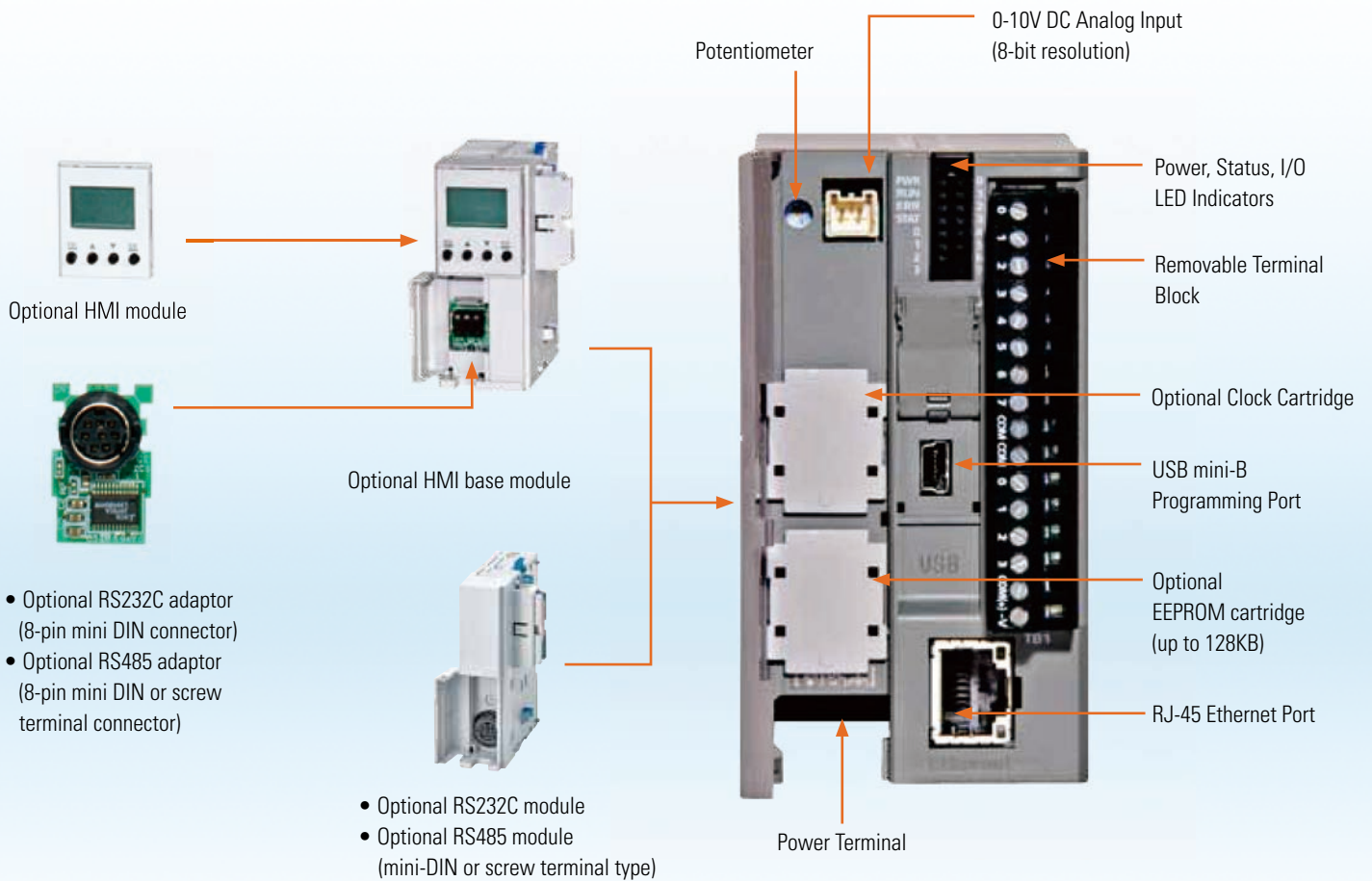

Modules snap together easily without the need for additional tools.

Slim CPU with Ethernet Port

The perfect design when you need Ethernet capability, this slim CPU with embedded Ethernet port is available with 24V DC power and equipped with eight DC inputs and four transistor outputs (sink or source). Up to seven functional modules, including analog and communication modules can be mounted on the right-hand expansion bus. Using an expansion interface module, an additional eight discrete expansion modules can be mounted.

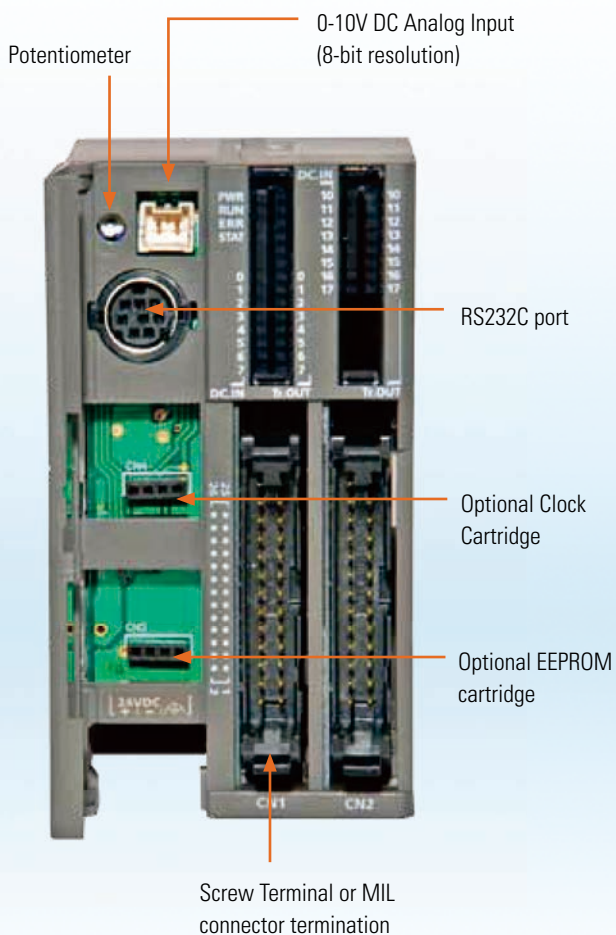

Slim CPU

If you don't need Ethernet, but still want a high-performance CPU, the MicroSmart Pentra slim CPU is your best choice! Available with 24V DC power, this controller has all the functionalities you need in 16 and 32 I/O configurations. Each 16 I/O CPU is equipped with eight DC inputs, two transistor outputs (sink or source) and six relay outputs, while the 32 I/O CPU is equipped with 16 DC inputs and 16 transistor outputs (sink or source).

All-in-One CPU

Available with 12V DC, 24V DC and 100-240V AC power, you can choose from 10, 16 and 24 I/O configurations. The 10 I/O CPU is equipped with six DC inputs and four relay outputs, while the 16 I/O CPU is equipped with nine DC inputs and seven relay outputs. The 24 I/O CPU is equipped with 14 DC inputs and ten relay outputs. The 24 I/O CPU (24V DC and 100-240V AC models) can also be expanded with a maximum of four functional or discreet expansion modules.



Communicate with Modbus Protocol

Modbus is a communications protocol, which over the years has become a standard in the automation industry. The main reasons for the extensive use of Modbus over other communications protocols are because it is:

- 1. Openly published and royalty-free
- 2. A relatively easy industrial network to deploy
- 3. Able to move raw bits or word data without placing many restrictions on vendors

Modbus is often used to connect a supervisory computer with a remote terminal unit (RTU) in supervisory control and data acquisition (SCADA) systems. All IDEC MicroSmart Pentra PLCs support Modbus protocol.

Using intuitive WindLDR software, you can configure the MicroSmart Pentra to be a Master or Slave device on a Modbus network. All MicroSmart Pentra PLCs support Modbus RTU/ASCII protocols and our CPU with embedded Ethernet port also supports Modbus TCP protocol.



Modbus Connectivity with TCP, RTU and ASCII

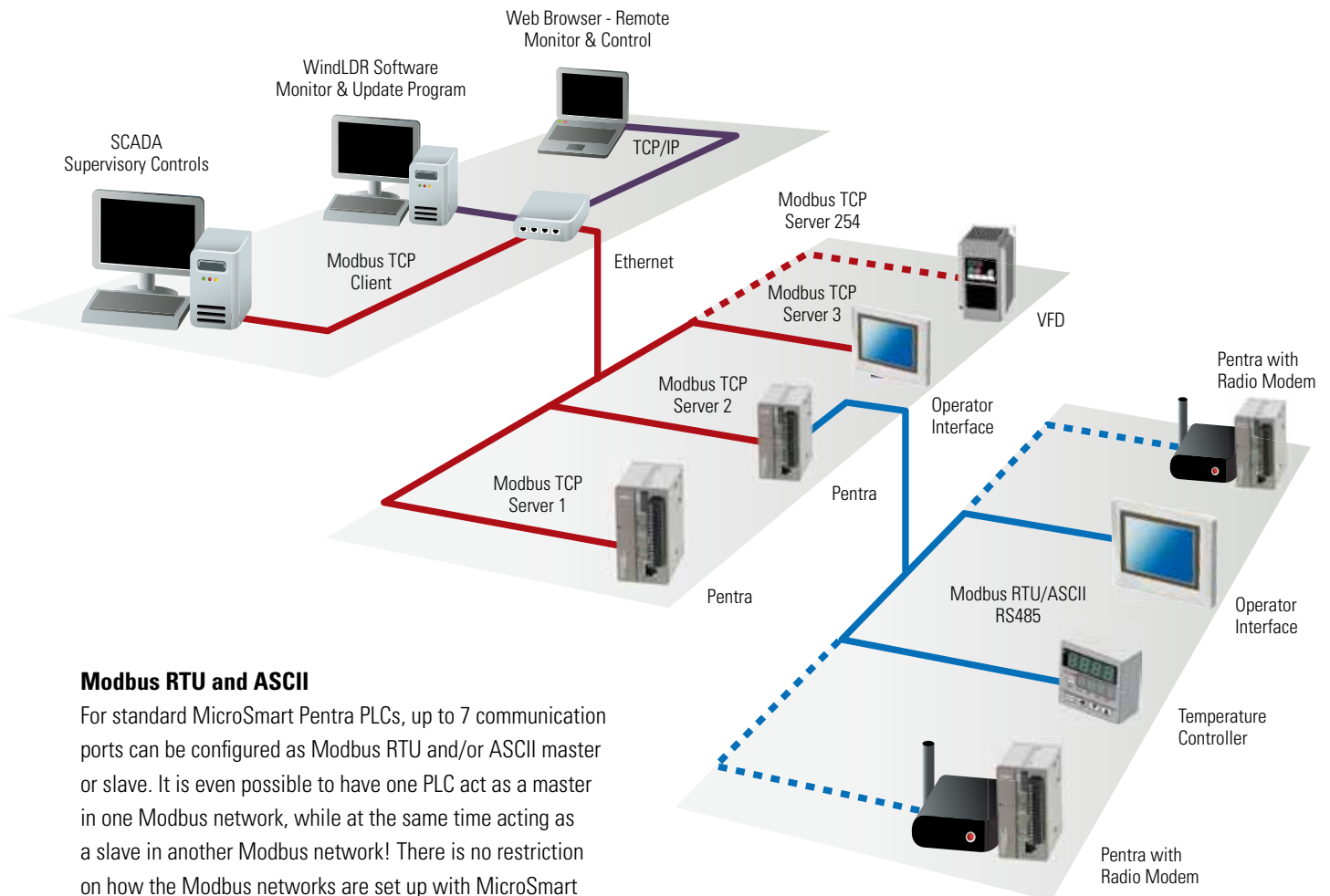

Modbus RTU and ASCII

For standard MicroSmart Pentra PLCs, up to 7 communication ports can be configured as Modbus RTU and/or ASCII master or slave. It is even possible to have one PLC act as a master in one Modbus network, while at the same time acting as a slave in another Modbus network! There is no restriction on how the Modbus networks are set up with MicroSmart Pentra PLCs.

Modbus TCP

MicroSmart Pentra PLCs with embedded Ethernet port support Modbus TCP Client (Master) or Server (Slave) communications. When the MicroSmart Pentra is configured as a client (master) on the Modbus TCP network, up to 3 connections can be established. Each master can send up to 255 requests to the slaves. On top of that, you can make connections to the PLC using WindLDR software for program monitoring, upload or download. You can also use a web browser for remote access to the PLC, even though the Ethernet port is already configured for Modbus TCP connections.

*“Seamless communication between all my devices is a big deal. And it doesn’t get easier than with a Pentra controller!”
– System Integrator*

Built-in Ethernet for fast, reliable connectivity



Ethernet is the fastest growing segment of industrial networking, allowing reliable access-from-anywhere capability and easy remote-data archiving. It makes sense: you can't always be in the same location as your machinery, but with IDEC MicroSmart Pentra PLCs, you don't need to be. Now you can monitor status in real-time, receive email alerts and customize your own web pages.

MicroSmart Pentra PLC with embedded Ethernet

With an easy-to-configure, built-in Ethernet port, you can set up your systems for remote access in no time.

Remote Access and Control

With this latest model, you can configure the MicroSmart Pentra PLC for remote monitoring and control. Using WindLDR software, you can remotely monitor or update the PLC programs without having to be near the PLC.

Web Server Functions

Using standard web browsers like Internet Explorer or Firefox, you can remotely log-in and access web pages that are stored directly on the MicroSmart Pentra PLC. Up to 1 MB of memory is dedicated for web page storage! Use the built-in web pages or create your own using an HTML editor.

Ping Functions

A new PING instruction, available in the MicroSmart Pentra PLCs with embedded Ethernet, allows the PLC to ping other PLCs or devices on a network to verify if that device is active or offline. It's a great way to make sure all your systems are working.

Instant Email and Text Alerts

Never have to worry that you will be out of touch with your control system. MicroSmart Pentra PLCs have the ability to send email or text messages to your inbox and mobile phone. You can instantly be notified if any abnormal conditions occur. Or simply have the PLC configure and send daily operational status updates. Not only can static information with up to 1,500 characters (1 byte per character) be sent in one message, but data register values can be incorporated as well.

A new EMAIL instruction is now available in WindLDR software. You can program as many EMAIL instructions as you prefer as long as you don't exceed the programming memory capacity. A total of 255 email messages can be configured in each PLC. Each email message can be sent to multiple recipients. That means you can have as many people receive the email as required! MicroSmart Pentra PLCs also support email login authentication, which requires each sender to be verified by a username and password.

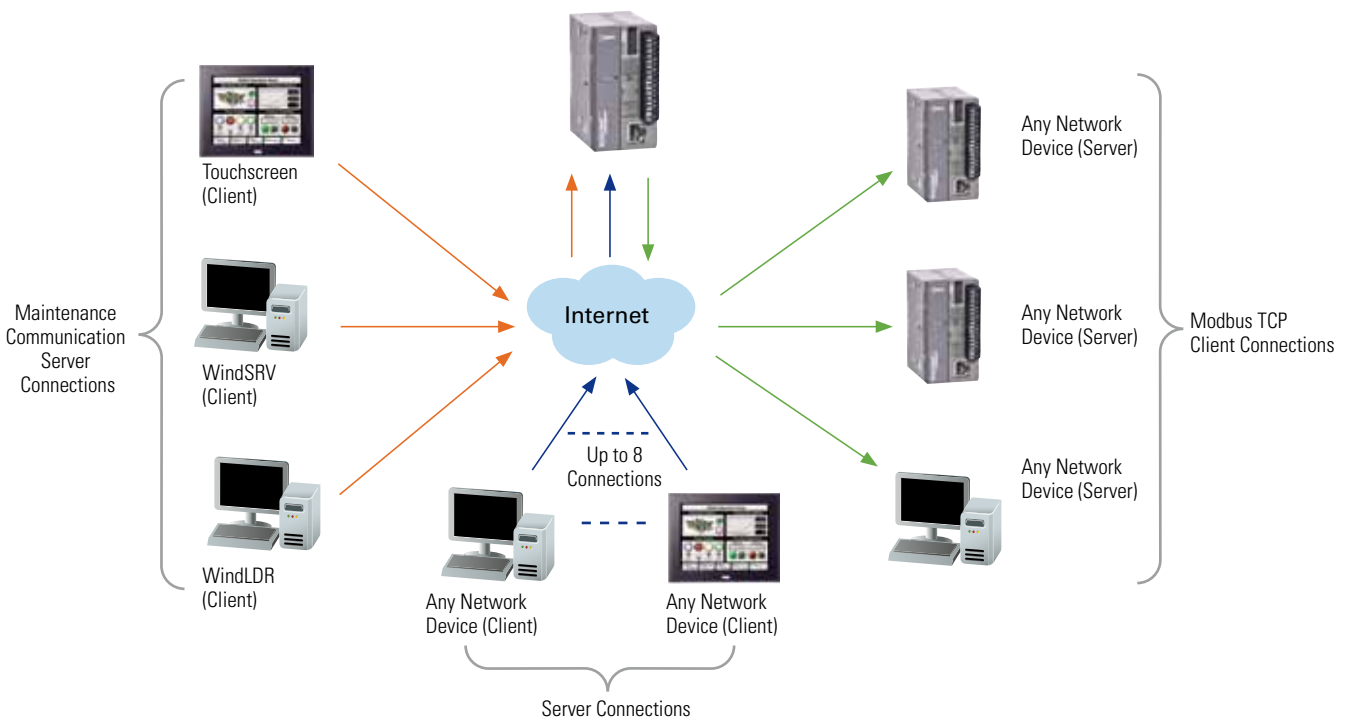
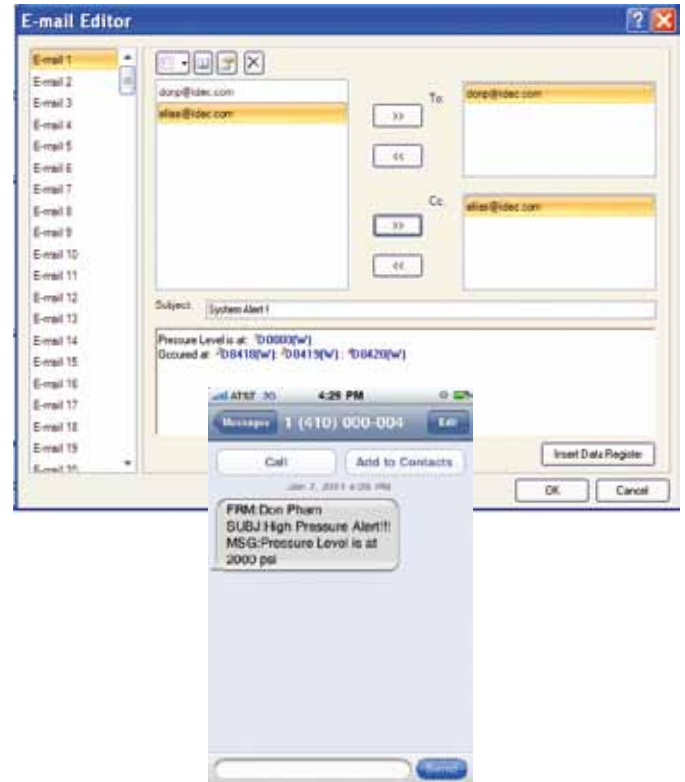

Up to 14 Simultaneous Connections

Using Maintenance Communication Server connections, up to 3 Client devices, such as an operator interface, WindLDR software and SCADA OPC server such as WindSRV (KepServerEx), can simultaneously communicate with your MicroSmart Pentra PLC. Using Server Connections, an additional 8 connections can be established and each connection can be defined as Maintenance, User Communication or Modbus TCP server protocol. On top of that, another 3 connections can be configured as Modbus TCP client protocol, with a maximum of 255 requests. Each request can be for different slave devices with different IP addresses on the network.

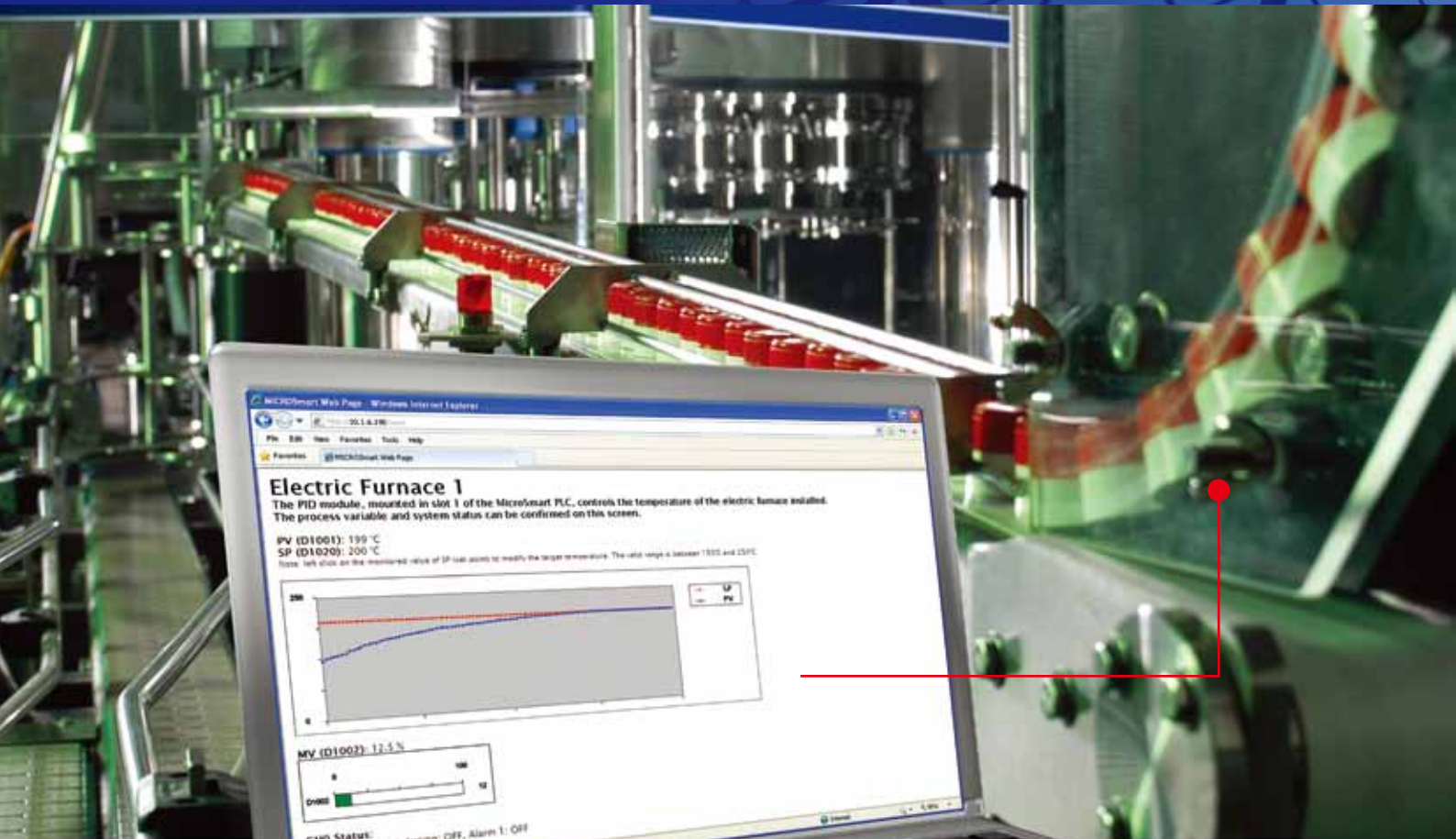

Customize critical data for quick online monitoring

Using the MicroSmart Pentra PLC with embedded Ethernet, you have the ability to design and create your own web page. Using a standard web browser, such as Internet Explorer or Firefox, critical information in the PLC can be accessed and controlled remotely over the web. Up to 1MB of memory is reserved for web server functions.

With your web page, data is easy to access and read. Your web page can display important parameters such as flow

rate, pressure, temperature, speed etc. of your system. These parameters can then be remotely monitored and updated. Need to change and update set points, no problem!

Using any standard HTML editor; design and create your own web pages and then import these files to the WindLDR software. WindLDR will download the HTML files to the embedded Ethernet MicroSmart Pentra CPU. It's that simple! Design it the way you want.

“With MicroSmart Pentra, I can check on our assembly lines right from the office, no matter where they're located. Makes my life a whole lot easier!” – Product Manager



Cellular modems let you connect anywhere

If your system is located in a remote, unpopulated area where a simple internet connection isn't available, monitoring equipment spread across a large geographic region can be difficult. Usually someone must drive to each location to manually monitor critical information, which is both time consuming and costly. So what do you do if an internet connection isn't available where your system is installed? A GSM/CDMA wireless modem lets you access your system remotely through mobile carriers in the GSM/CDMA network.

MicroSmart Pentra PLCs have been installed in various applications where they provide seamless communications through a third party GSM/CDMA cellular modem and its network. Data can then be streamed from the PLC to your servers or central office. Critical information can be remotely accessed 24/7, even in systems deployed in remote and unpopulated areas where internet service is not accessible.

- Reliable cellular connections
- 24/7 monitoring
- Alarms and system status alerts
- Remote updating for PLC programs

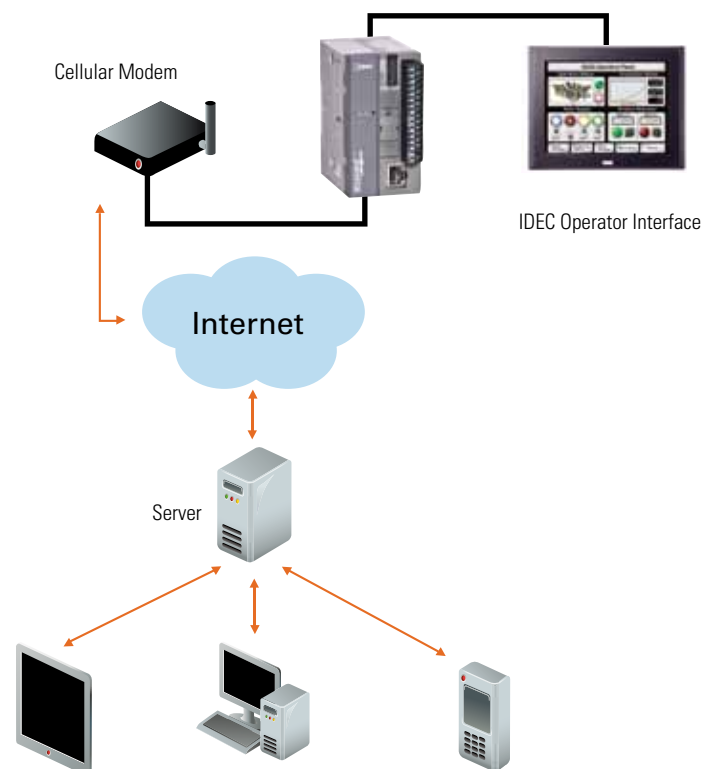

Connect your devices by expanding to 7 ports

Just imagine all the possibilities you will experience with the flexibility of a powerful MicroSmart Pentra Slim PLC. You can configure and seamlessly communicate with as many as 7 serial devices via RS232C or RS485. MicroSmart Pentra PLCs are the only micro PLC in the market to combine so much power and flexibility in one controller.

Communicate to any device

With MicroSmart Pentra PLCs, you don't have to worry about limited communication capabilities. It doesn't matter if you're just starting out or a current user expanding your MicroSmart Pentra PLC, you can rest assured that these communication modules will provide reliable and seamless communication. If RS485 modules are used for all six ports (one RS485 communication module and five SIF4 modules), up to 186 RS485 slave devices can be connected with as high as a 115K baud rate available for fast transmission.

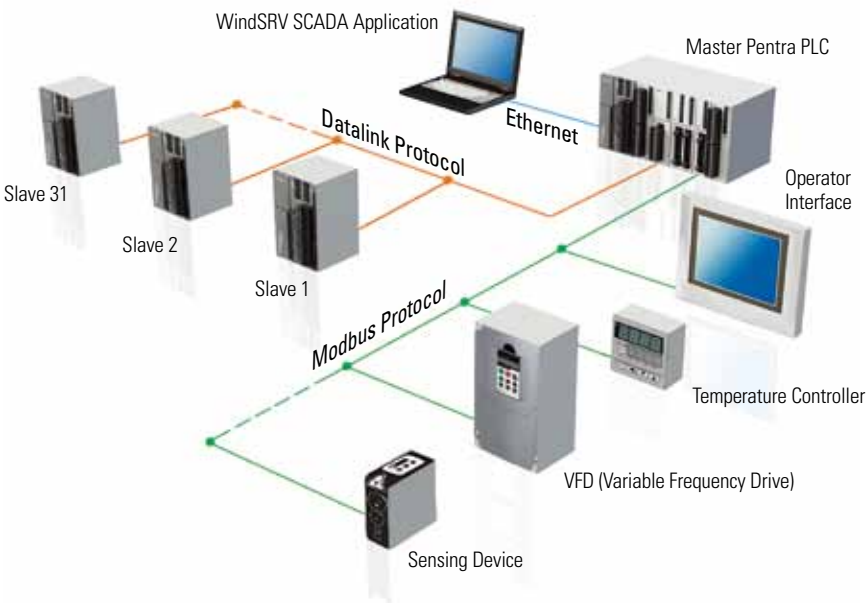

Multiple networks of Modbus protocols

IDEC MicroSmart PLCs can support Modbus communication protocol and each of the seven communication ports support Modbus protocol. You can configure one port to talk Modbus RTU master, another port for Modbus RTU slave, and more.

Network thousands of I/Os

Using IDEC Datalink and/or Modbus protocol, you can configure tens of thousands of I/Os with one MicroSmart Pentra PLC.

Boost the speed of productivity

The success of your system might be dependent on a few milliseconds. Many micro controllers lack the necessary tools for accuracy at any speed, much less at the high speeds modern applications require. MicroSmart PLCs have always had the capability to operate high speed inputs and outputs, but MicroSmart Pentra PLCs can go even faster, up to 100kHz – and so can your productivity.

High-speed inputs

- Four high-speed inputs with a maximum frequency of 100kHz
- Supports single/dual phase inputs for rotary encoders
- 32-bit counting range up to 4,294,967,295 pulses
- Integrated Functions
 - Execute Interrupt Programs
 - Frequency Measurement
 - High Speed Counter Refresh
 - Multi Stage Comparison

High-speed outputs

Configure as many as three high speed pulse outputs, up to 100kHz, and get the simple control you want for stepper or servo motors.



Connect up to 56 analog devices



Process controls play an important part in industrial machines. Analog signals such as pressure transducers, float switches, flow meters, valves, temperature, analog sensors and more, need to be correctly analyzed and controlled. MicroSmart Pentra PLCs offer a wide range of solutions, including 0-10V DC, 4-20mA, resistance thermometer, thermistor and thermocouple inputs, and -10 to 10V DC and 4-20mA outputs. Analog modules are available in 12 or 16-bit resolution, providing a precise reading and fast throughput.

Expand to 56 Analog I/O

7 analog I/O expansion modules can be configured on MicroSmart Pentra PLCs. That's a total of 56 analog channels that you can utilize!

Revolutionary universal input module

IDEC also offers a universal analog input module. This 4-pt universal analog input module can accept any of the following types of analog signals: 4-20mA, 0-10V DC, resistance thermometer and type J, K or T thermocouple!

Easy to configure and scale

Setting up analog modules in your PLC system should not be a challenge. Using our analog setting macro instruction in WindLDR software, you can easily set up and scale your analog signals in no time at all.

Part Number	I/O Points	Input	Output	Resolution
FC4A-J8C1	8 (8 inputs)	0-10 VDC, 4-20 mA	-	16-bit (0-50,000)
FC4A-L03A1	3 (2 inputs, 1 output)	0-10 VDC, 4-20 mA, RTD, Thermocouple	0-10 VDC, 4-20 mA	12-bit (0-4095)
FC4A-J2A1	2 (2 inputs)		-	
FC4A-J4C1	4 (4 inputs)		16-bit (0-50,000)	
FC4A-L03AP1	3 (2 inputs, 1 output)	RTD, Thermocouple	0-10 VDC, 4-20 mA	12-bit (0-4095)
FC4A-J8AT1	8 (8 inputs)	Thermistor (NTC/PTC)	-	12-bit (0-4000)
FC4A-K4A1	4 (4 outputs)	-	0-10 VDC, 4-20 mA	12-bit (0-4095)
FC4A-K2C1	2 (2 outputs)		-10 to 10 VDC, 4-20 mA	16-bit (0-50,000)
FC4A-K1A1	1 (1 output)		0-10 VDC, 4-20 mA	12-bit (0-4095)

Choose from a wide range of available modules.

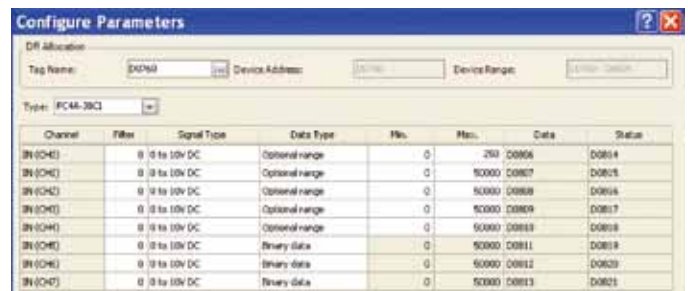

Modules are easy to configure using WindLDR software.

Advanced PID for precision control

PID (Proportional Integral Derivative) is the most commonly used feedback control loop in industrial control systems. PID calculates an error value as the difference between a measured process variable and a desired set point. The controller then attempts to minimize the error by adjusting the process control. With MicroSmart Pentra PLCs, PID implementation can be deployed in two ways: integrated PID controls or a dedicated Process Control module, which can be mounted on the MicroSmart Pentra expansion bus.

Integrated PID Controls

Using built-in PID functions in the MicroSmart Pentra PLCs, and in conjunction with analog I/O expansion modules, a maximum of 56 PID loops can be programmed. A PID Macro instruction in WindLDR software is also available to guide you through the process of setting up and tuning the P, I and D parameters. You can also select from various control modes including Auto-tuning, Advanced Auto-tuning or Manual.

Advanced PID Module

A dedicated PID module is available for extreme stability and complex applications. This particular module has more functionalities than you will find in any other controller on the market. Independent of CPU scan time, the PID Control module does the work, reducing PLC scan time without taking up PLC memory space.

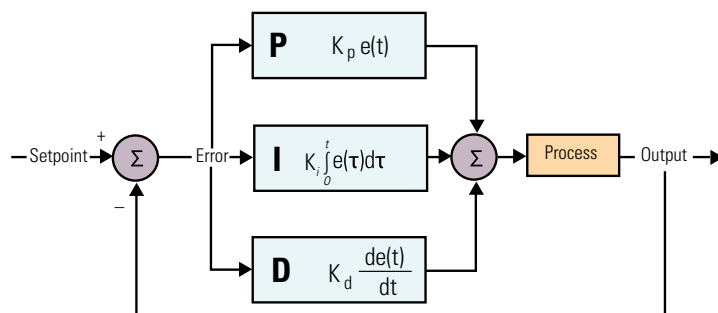

PID Module Highlights:

- Precise, stable and accurate PID control with less than a 0.2% error
- Available in two models:
 - Built-in 2 analog inputs, 2 x 4-20mA/ non-contact voltage for SSR drive
 - Built-in 2 analog inputs, 2 x relay outputs
- Each input individually configured to accept different signal types
- Up to seven modules can be mounted on the MicroSmart Pentra
- Maximum 14 PID loops with auto-tuning
- 14-bit resolution
- ARW (anti-reset windup)
- Accepts many different input types including:
 - Type K, J, R, S, B, E, T, C, PL-II and N thermocouples
 - Resistance thermometer
 - 0-20mA and 4-20mA
 - 0-1V, 0-5V, 1-5V, and 0-10V DC
- Numerous control methods including:
 - Cascade
 - External set point
 - Heating and cooling control action
 - Difference input control



Solar ready 12V DC models

With abundant features and unparalleled performance, 12V DC MicroSmart Pentra PLCs are the perfect choice for solar applications, including traffic signs, light controls, road sign controls, remote pumping and injection systems for oil and gas industries, remote water pumping stations and solar tracking systems. For mobile applications, these PLCs can be employed in utility vehicles such as cement mixers, lift controls for the handicapped, lighting and even designation signs for vans and buses.

“12V DC MicroSmart controllers are compact enough to fit in a tight space, while providing the controls I need.” – Engineer





Meets rigorous maritime standards

FC5A/FC4A series PLCs are one of the few PLCs in the market approved for maritime applications. Our PLCs are widely used in both marine and offshore applications.

We are dedicated to ensuring the safety of life and property at sea. Our FC5A/FC4A series PLCs are trusted and approved by leading maritime classification agencies, such as ABS (American Bureau of Shipping), DNV (Det Norske Veritas), GL (Germanischer Lloyd) and LR (Lloyd's Register of Shipping).

MicroSmart Pentra PLCs are the perfect solution for all your maritime applications! The MicroSmart Pentra PLC combines power and ease-of-use to give you a simple and flexible programming concept that can be tailored to your specific application.

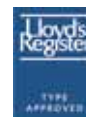

Note: The following part numbers are pending approval from ABS, DNV and Lloyd's FC5A-D12, FC4A-K4A1, FC5A-F2M2, FC5A-F2MR2, FC5A-SIF2, FC5A-SIF4, FC5A-C**R2D, FC5A-EXM*, FC4A-SX5ES*, FC4A-AS62M, FC4A-N08A11.*

A fast and flawless OPC solution

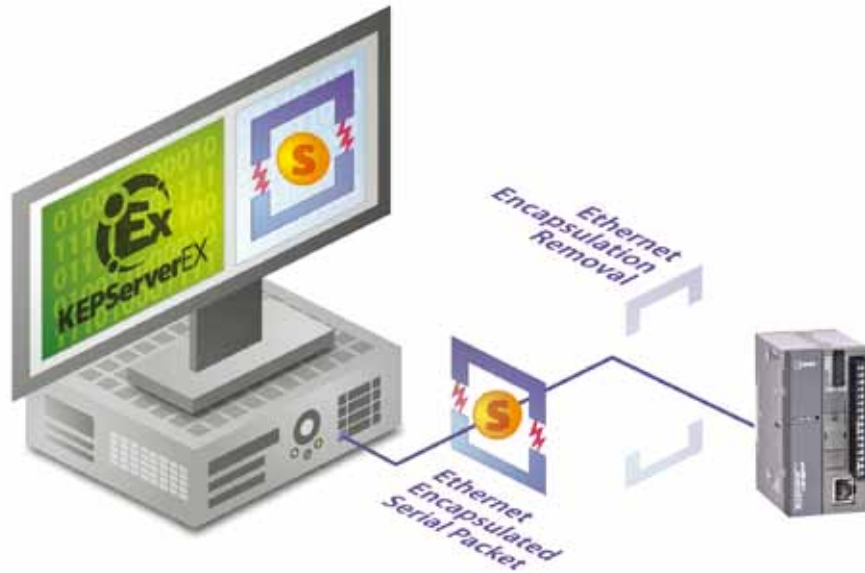

Want your control systems centralized, easy-to-manage and able to take advantage of the components you already have? WindSRV, also known as KEPServerEX, is an OPC server that provides direct connectivity between client applications and IDEC MicroSmart Pentra PLCs. It's a true plug-and-play OPC Server with effortless data management, acquisition, monitoring and control. Plus it supports complete addressing, including 32-bit data and floating point data.

Industrial strength, easy to use OPC Server

The intuitive interface makes connecting IDEC MicroSmart Pentra PLCs so easy that within minutes you can be providing data to your application. KEPServerEX maximizes the promise of OPC through the use of a single server interface, ensuring:

- Shorter product learning curves
- Reduced system training and maintenance costs
- Improved network reliability

Control at your fingertips

A maximum of 100 MicroSmart/MicroSmart Pentra PLCs can be connected. Imagine having the ability to centrally monitor and control your whole plant, at your fingertips.

Quick Client

Using Quick Client, you can access all data available to the server application, including System, Diagnostic- and User-defined tags. After you've created a simple KEPServerEX project, auto launch Quick Client from the server toolbar to test your device connection.

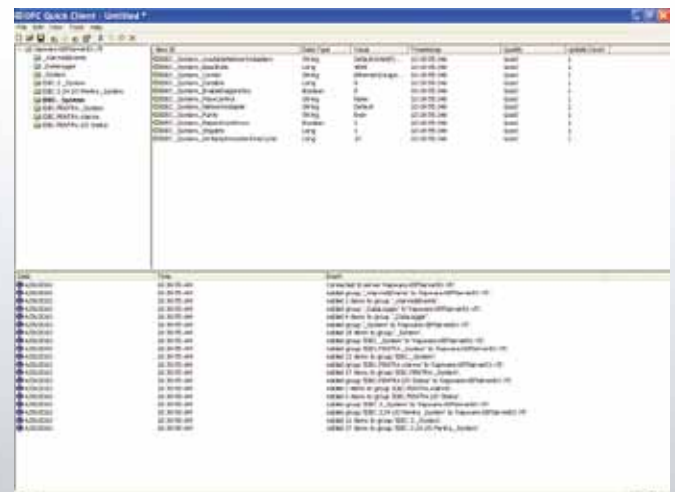

Fastest micro PLC in its class



Fast Processing Speed

MicroSmart Pentra Slim CPU is the fastest PLC in its class. In fact, the overall processing speed of our new Logic Engine CPU is 16 times faster than our competitor's average controller for simple instruction execution, and more than 14 times faster when executing advanced instruction sets.

USB maintenance port

The new MicroSmart Pentra PLC with an embedded Ethernet PLC port also has an embedded mini-B USB port for maintenance. You can now easily connect your PC to this PLC using a standard USB cable.

Expanded Memory

You won't run out of program memory space with our MicroSmart Pentra PLCs. The slim type CPU supports up to 62K bytes (10,400 steps) of programming memory. And if that's still not enough for your applications, a new optional memory cartridge for the embedded Ethernet PLC is now available with 128K bytes (21,300 ladder steps).

MicroSmart Pentra is also equipped with:

- 48,000 Data Registers
- 2,048 Internal Relays
- 256 Timers
- 256 Counters

FREE Upgradeable Firmware

MicroSmart Pentra PLCs can keep up with your always expanding applications. This is thanks to field upgradeable firmware that allows you to upgrade and download system firmware as needed. And you never have to worry new features and functions won't be compatible with your MicroSmart Pentra PLC. The newest firmware is always available when you download our most recent version of Automation Organizer suite. Upgrades are always free to our users.

Comments and Tags download

With up to 128K bytes of programming memory, you are free to load as much information into the PLC as you like. All comments and tag identification can be downloaded and will reside in the PLC for better understanding and clarification. No other micro PLC can offer this much programming memory and more importantly, flexibility.

MicroSmart Pentra Slim CPU Speed Comparison (µsecs)

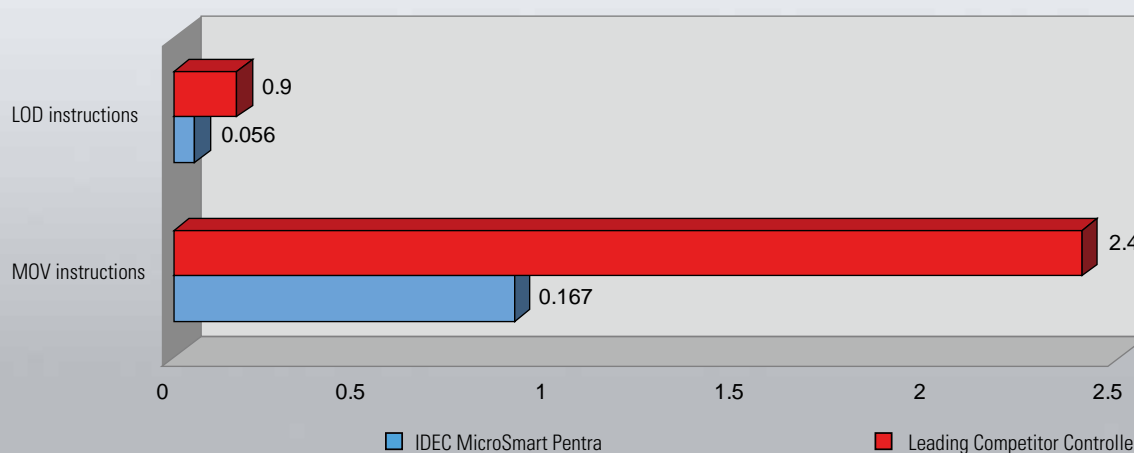

Automation Organizer lets you design, debug and document

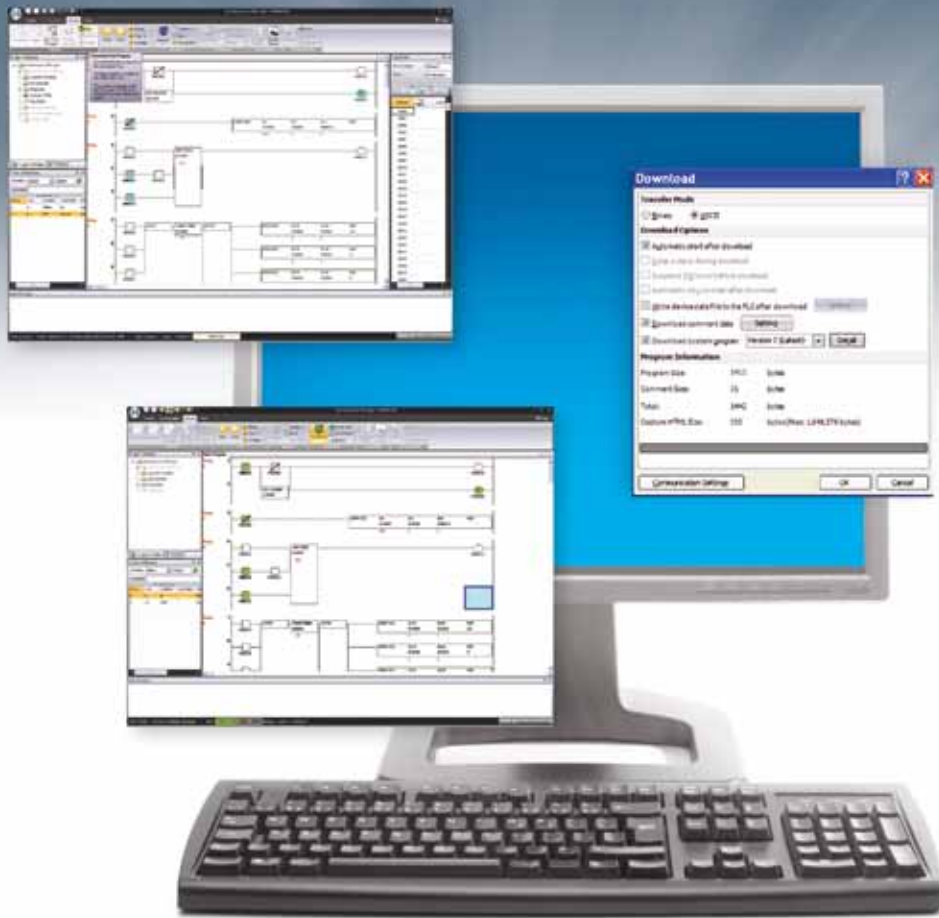

Automation Organizer (AO) is a powerful software suite containing PLC programming software (WindLDR), operator interface configuration software (WindO/I-NV2) and system configuration software (WindCFG). AO boasts a completely new graphic user interface and redesigned menu icons. AO is a one-stop automation software package for IDEC MicroSmart Pentra PLCs and IDEC operator interfaces, and is compatible with Windows XP, Vista (32 bit) and Windows 7 (32 and 64-bit).

FREE Upgrades

The Automation Organizer suite comes with free lifetime upgrades. Once you make the initial purchase, upgrades are absolutely free.

"AO just makes sense. It's the little things like a common tag name database for both my PLC and HMI controls." - Engineer



Automation Organizer WindLDR

All IDEC MicroSmart Pentra PLCs are programmable with WindLDR ladder logic software. This icon-driven programming tool combines logic and intuition with an incredibly easy-to-use interface to allow you to take advantage of MicroSmart features. Even without ladder program experience, you can use the built-in editors, shortcuts and debuggers to configure programs. WindLDR is an excellent, long-term investment for your control solutions.

- **Simulation Mode**

WindLDR allows you to simulate ladder programs with built-in Simulation mode. You can easily test and verify functionality of your ladder program without actual hardware.

- **Online Editing**

Shutting down your PLC for minor changes can be a major hassle, so WindLDR allows you to edit and download programs without interrupting PLC operation. You can write new values to counters, timers and registers at any time without switching between editor mode (for programming) and monitor mode.

- **Firmware Download**

With WindLDR version 6.4 or later, you have the option to upgrade or downgrade your CPU system program. It's as simple as clicking on the checkbox in the Download dialog box. Now you can easily update your PLC system firmware with the click of a button.



Automation Organizer WindO/I-NV2

WindO/I-NV2 software is the programming tool available for all IDEC operator interfaces. It is used to create projects or programs that can display information from a PLC, process status, or can be used to input data with virtual switches or keypads to make changes to a process. The objects are extremely easy to configure with the help of step-by-step navigation. It lets you quickly create colorful graphical screens in no time using drop-down menus and intuitive drag and drop functionality for the objects. A workspace is available to help you organize and manage projects, objects and screens.



Automation Organizer WindCFG

WindCFG is a system layout and configuration tool for IDEC PLCs and operator interfaces. Using WindCFG, you can create a visual layout of the system design and basic configuration of your PLC and operator interfaces.

CPU Highlights

No matter your application, FC5A and FC4A have the features you need!

CPU Series		FC5A							
CPU Type		Slim Type			All-in-One Type				
CPU I/O size		32 I/Os	16 I/Os	Web Server CPU Module	24 I/Os		16 I/Os	10 I/Os	
				12 I/Os	24V DC type AC type	12V DC			
Inputs		16	8	8	14		9	6	
Outputs	Relay	-	6	-	10		7	4	
	Transistor	16	2	4	-		-	-	
Max. I/Os		512 *1	496 *1	492 *1	88 *2	24	16	10	
Program Capacity		62.4KB			127.8KB		54KB	27KB	13.8KB
Instruction Excecuting Time	Basic Instruction	LOD: 0.056 us (=micro sec.)			LOD: 0.7 us (=micro sec.)				
	Advanced Instruction	MOV: 0.167 to 0.278 us (=micro sec.)			MOV: 33 us (=micro sec.)				
High-speed Counter Max. counting frequency		100kHz single/ two phase-selectable: 2 points 100kHz Single-phase: 2 points			50kHz single/ two phase-selectable: 1 point 5kHz Single-phase: 3 points				
Pulse Output (Trapezoidal Control)		100kHz (3-axis simultaneous control): 2 points	100kHz (2-axis simultaneous control): 2 points	100kHz (3-axis simultaneous control): 2 points	-				
PID Control	Combination with Analog module	Possible Max. 56ch			Possible Max. 28ch	-	-	-	
	PID Module	Possible Max. 14ch			Possible Max. 8ch	-	-	-	
Analog Potentiometer		1ch			2ch	2ch	1ch	1ch	
Built-in Analog Input (0-10V DC)		1ch			-				
Timer Interrupt Functions		Possible			Possible				
Communication Function Expandability	Maximum Ports	7 ports		8 ports	5 ports	2 ports	2 ports	2 ports	
	USB mini-B	Built in CPU	-	-	1 port	-			
		Built in CPU	-	-	1 port	-			
	Ethernet	FC4A Web Server Unit	Max. 7 modules		Max. 6 modules	Max. 5 modules	Max. 2 modules	Max. 2 modules	Max. 2 modules
		Built in CPU	1 port	1 port	-	1 port			
	RS232C	Communication Adapter	-			1pce			
		Communication Module	1 module			-			
		Expansion RS232C Comm. Module	Max. 5 modules			Max. 3 modules	-	-	-
	RS485	Communication Adapter	-			1pce			
		Communication Module	1 module			-			
		Expansion RS485 Comm. Module	Max. 5 modules			Max. 3 modules	-	-	-
	Modbus Function		Master/slave function (standard feature)			Master/slave function (standard feature)			
Option Module Combination	AS-Interface Master Module	Max. 2 modules			Max. 2 modules	-	-	-	
	Analog I/O Module	Max. 7 modules			Max. 4 modules	-	-	-	
	Analog I/O Module & AS-Interface Master Module	Possible			-				
	Analog I/O Module & Expansion RS232C or RS485 Communication Module	Possible			-				
	PID Module	Max. 7 modules			Max. 4 modules	-	-	-	
	PID Module & AS-Interface Master Module	Possible			-				
	PID Module & Expansion RS232C or RS485 Communication Module	Possible			-				
	Analog Module & PID Module	Possible			Possible	-	-	-	
	AS-Interface Master Module & Expansion RS232C or RS485 Communication Module	Possible			-				
	Expansion Interface Module	Possible			-				
Web Server Module	Possible			Possible					
Width (mm)		47.5			95.0		80.0		
Power Voltage		24V DC			FC5A-C**R2 (AC type): 100V to 240V AC (50/60 Hz) FC5A-C**R2C (24V DC type): 24V DC FC5A-C**R2D (12V DC Type): 12V DC				

*1. When using expansion I/O modules and expansion interface modules.

*2. When using expansion I/O modules.

CPU Series		FC4A					
CPU Type		Slim Type			All-in-One Type		
CPU I/O size		40 I/Os	20 I/Os		24 I/Os	16 I/Os	10 I/Os
Inputs		24	12	12	14	9	6
Outputs	Relay	-	6	-	10	7	4
	Transistor	16	2	8	-	-	-
Max. I/Os		264 *2	244 *2	148 *2	88 *2	16	10
Program Capacity		31.2KB		27KB	27KB	15KB	4.8KB
Instruction Executing Time	Basic Instruction	LOD: 1 us (=micro sec.)			LOD: 1 us (=micro sec.)		
	Advanced Instruction	MOV: 46 us (=micro sec.)			MOV: 46 us (=micro sec.)		
High-speed Counter Max. counting frequency		20kHz single/ two phase-selectable: 2 points 5kHz Single-phase: 2 points			20kHz single/ two phase-selectable: 1 point 5kHz Single-phase: 3 points		
Pulse Output (Trapezoidal Control)		20kHz(1 or 2-axis control): 2 points			-		
PID Control	Combination with Analog module	Possible Max. 56ch			Possible Max. 28ch	-	-
	PID Module	-			-	-	-
Analog Potentiometer		1ch			2ch	1ch	1ch
Built-in Analog Input (0-10V DC)		1ch			-		
Timer Interrupt Functions		Possible	Possible	-	-		
Communication Function Expandability	Maximum Ports		2 ports		2 ports		1 port
	USB mini-B	Built in CPU		-		-	
		Ethernet		-		-	
	FC4A Web Server Unit	-		-		-	
		Max. 2 modules		Max. 2 modules		1 module	
	RS232C	Built in CPU		1 port		1 port	
		Communication Adapter		-		1pce	
		Communication Module		1 module		-	
		Expansion RS232C Comm. Module		-		-	
	RS485	Communication Adapter		-		1pce	
		Communication Module		1 module		-	
		Expansion RS485 Comm. Module		-		-	
	Modbus Function		-		-		
	Option Module Combination	AS-Interface Master Module		1 module		-	
Analog I/O Module		Max. 7 modules		Max. 4 modules			
Analog I/O Module & AS-Interface Master Module		Possible		-			
Analog I/O Module & Expansion RS232C or RS485 Communication Module		-		-			
PID Module		-		-			
PID Module & AS-Interface Master Module		-		-			
PID Module & Expansion RS232C or RS485 Communication Module		-		-			
Analog Module & PID Module		-		-			
AS-Interface Master Module & Expansion RS232C or RS485 Communication Module		-		-			
Expansion Interface Module		-		-			
Web Server Module		Possible		Possible			
Width (mm)		47.5	35.4	95.0	80.0	80.0	
Power Voltage		24V DC			FC4A-C**R2(AC type): 100V to 240V AC (50/60 Hz) FC4A-C**R2C(DC type): 24V DC		

*2. When using expansion I/O modules.

MicroSmart PLC Specifications and Technical Data

High-performance quality programmable logic controller with world-class processing speed. Compact body packed with outstanding features. New slim type CPU module available with web server function, ideal for remote control. (FC5A-D12*1E)

microSmart
pentra

- New FC5A slim type modules available with web server function, send email function, n:n communication by Modbus communication, PING function. Supports user web page. (FC5A-D12*1E)
- Equipped with a USB port (mini-B) and Ethernet port for easy maintenance, remote control and monitoring. (FC5A-D12*1E)
- World-class processing speed.
Logic Engine performance:
 - Basic instruction LOD 0.056 μs
 - Advanced instruction MOV 0.167 μs (FC5A slim type only)
- Equipped with Modbus ASCII/RTU master/slave function (FC5A).
- FC5A slim type expandable up to 512 I/O points (when expansion interface modules are used).
- Full line up of analog modules including 4-point analog output module.
- FC5A PID module with high accuracy and high functionality available.



MicroSmart

•FC5A CPU Modules

Type	High-speed Counter Pulse Output	Power	Input Type	Output Type	High-speed Transistor Output	Interface	I/O Points	Type No.
Slim	<ul style="list-style-type: none"> • High-speed counter Maximum input frequency: 100 kHz • Pulse output Maximum output frequency: 100 kHz 	24V DC	24V DC (Sink/Source)	Relay Output 2A 240V AC, 2A 30V DC, 2A	Sink Output 0.3A Source Output 0.3A	Port 1 (RS232C)	8/8 points (Note) 496 points max.	FC5A-D16RK1
							16/16 points 512 points max.	FC5A-D16RS1
							8/4 points 492 points max.	FC5A-D32K3
								FC5A-D32S3
						Port 1 (USB mini-B port) Ethernet port	FC5A-D12K1E	
							FC5A-D12S1E	
All-in-One	<ul style="list-style-type: none"> • High-speed counter Maximum input frequency: 50 kHz 	12V DC	12V DC (Sink/Source)	Relay Output 2A 240V AC, 2A 30V DC, 2A	—	Port 1 (RS232C)	6/4 points	FC5A-C10R2D
		100V to 240V AC (50/60 Hz)	24V DC (Sink/Source)				9/7 points	FC5A-C16R2D
							14/10 points	FC5A-C24R2D
							6/4 points	FC5A-C10R2
		24V DC	24V DC (Sink/Source)				9/7 points	FC5A-C16R2
							14/10 points 88 points max.	FC5A-C24R2
							6/4 points	FC5A-C10R2C
							9/7 points	FC5A-C16R2C
		14/10 points 88 points max.	FC5A-C24R2C					

Note: Two points are transistor output and six points are relay outputs.

•FC4A CPU Modules

Type	High-speed counter Pulse Output	Power	Input Type	Output Type	High-speed Transistor Output	I/O Points	Type No.
Slim	<ul style="list-style-type: none"> • High-speed counter Maximum input frequency: 20 kHz • Pulse output Maximum output frequency: 20 kHz 	24V DC	24V DC (Sink/Source)	Relay Output 2A 240V AC, 2A 30V DC, 2A	Sink Output 0.3A Source Output 0.3A	12/8 points	FC4A-D20K3
						148 points max.	FC4A-D20S3
						12/8 points (Note) 244 points max.	FC4A-D20RK1
							FC4A-D20RS1
						24/16 points 264 points max.	FC4A-D40K3
							FC4A-D40S3
All-in-One	<ul style="list-style-type: none"> • High-speed counter Maximum input frequency: 20 kHz 	100V to 240V AC (50/60 Hz)	24V DC (Sink/Source)	Relay Output 2A 240V AC, 2A 30V DC, 2A	—	6/4 points	FC4A-C10R2
		24V DC				9/7 points	FC4A-C16R2
						14/10 points 88 points max.	FC4A-C24R2
						6/4 points	FC4A-C10R2C
		24V DC				9/7 points	FC4A-C16RC2
						14/10 points 88 points max.	FC4A-C24R2C

Note: Two points are transistor output and six points are relay outputs.

•Input Modules

Input Type	Input Points	Terminal	Type No.
24V DC (Sink/Source)	8 points	Removable Terminal Block	FC4A-N08B1
	16 points		FC4A-N16B1
	16 points	MIL Connector	FC4A-N16B3
	32 points		FC4A-N32B3
100 to 120V AC (50/60Hz)	8 points	Removable Terminal Block	FC4A-N08A11

•Output Modules

Output Type	Output Points	Terminal	Type No.
Relay Output 240V AC/30V DC	8 points	Removable Terminal Block	FC4A-R081
	16 points		FC4A-R161
Transistor Sink Output 0.3A	8 points		FC4A-T08K1
Transistor Source Output 0.3A	8 points		FC4A-T08S1
Transistor Sink Output 0.1A	16 points	MIL Connector	FC4A-T16K3
Transistor Source Output 0.1A			FC4A-T16S3
Transistor Sink Output 0.1A	32 points		FC4A-T32K3
Transistor Source Output 0.1A			FC4A-T32S3

•Mixed I/O Modules

Input Type	Output Type	I/O Points	Terminal	Type No.
24V DC (Sink/Source)	Relay Output	8 (4 in/4 out)	Removable Terminal Block	FC4A-M08BR1
	240V DC/30V DC, 2A	24 (16 in/8 out)	Non-removable Terminal Block	FC4A-M24BR2

•Analog I/O Modules

Name	Input Type	Output Type	I/O Points	Terminal	Type No.	
Analog I/O Module	Voltage (0 to 10V DC) Current (4 to 20mA)	Voltage (0 to 10V DC) Current (4 to 20mA)	2 inputs 1 output	Removal Terminal Block	FC4A-L03A1	
	Thermocouple Resistance Thermometer				FC4A-L03AP1	
Analog Input Module	Voltage (0 to 10V DC) Current (4 to 20mA)	-	2 inputs		FC4A-J2A1	
	Voltage (0 to 10V DC) Current (4 to 20mA) Thermocouple Resistance Thermometer		4 inputs		FC4A-J4CN1	
	Voltage (0 to 10V DC) Current (4 to 20mA)		8 inputs		FC4A-J8C1	
	Thermistor (NTC, PTC)		8 inputs		FC4A-J8AT1	
Analog Output Module	-	Voltage (-10 to +10V DC) Current (4 to 20mA)	2 outputs		FC4A-K2C1	
			Voltage (0 to 10V DC) Current (4 to 20mA)		1 output	FC4A-K1A1
			Voltage (-10 to 10V DC) Current (4 to 20mA)		4 outputs	FC4A-K4A1

•PID Modules

Name	Terminal	Type No.
Relay Output Type × 2ch	Non-removable Terminal Block	FC5A-F2MR2
Voltage / Current Output Type × 2ch		FC5A-F2M2
User's Manual		FC9Y-B1283

•AS-Interface Master Modules

Name	Terminal	Type No.
AS-interface Master Module	Removable Terminal Block	FC4A-AS62M

•Web Server Unit

Name	Type No.
Web Server Unit	FC4A-SX5ES1E
Web Server Cable (10 cm)	FC4A-KC3C
User's Manual	FC9Y-B919

•Expansion Interface Modules

Name	Type No.
Expansion Interface Master Module	FC5A-EXM1M
Expansion Interface Slave Module	FC5A-EXM1S
Expansion Interface Module	FC5A-EXM2
Expansion Interface Cable (1m)	FC5A-KX1C

•HMI Module

Name	Type No.
HMI Module	For displaying and changing required operands FC4A-PH1
HMI Base Module	For mounting HMI module with slim type CPU module FC4A-HPH1

•Expansion RS232C Communication Module

Type	Type No.
RS232C, 1 Port	FC5A-SIF2

•Expansion RS485 Communication Module

Type	Type No.
RS485, 1 Port	FC5A-SIF4

•Communication Modules (For Slim CPU)

Name	Type No.
RS232C Communication Module	Mini DIN Connector Type FC4A-HPC1
RS485 Communication Module	Mini DIN Connector Type FC4A-HPC2
	Terminal Block Type FC4A-HPC3

•Programming Software

Name	Type No.
Application Software Automation Organizer WindLDR V.6 or higher	SW1A-W1C
Programming and Monitoring Software WindLDR Ver. 5.*	FC9Y-LP2CDW

•Option

Name		Type No.		
RS232C Communication Adapter	Mini DIN Connector	FC4A-PC1		
RS485 Communication Adapter	Mini DIN Connector	FC4A-PC2		
RS485 Communication Adapter	Terminal Block	FC4A-PC3		
Clock Cartridge		FC4A-PT1		
Memory Cartridge	32 KB	FC4A-PM32		
	64 KB	FC4A-PM64		
	128 KB	FC4A-PM128		
RS232C/RS485 Converter		FC2A-MD1		
AC Adapter		PFA-1A31		
26-position Connector Socket	MIL connector for slim type CPU modules (package quantity 2)	FC4A-PMC26PN02		
20-position Connector Socket	MIL connector for I/O modules (package quantity 2)	FC4A-PMC20PN02		
10-position Terminal Block	For I/O modules (package quantity 2)	FC4A-PMT10PN02		
11-position Terminal Block		FC4A-PMT11PN02		
13-position Terminal Block	For slim CPU modules FC5A-D16R*1 (package quantity 2)	FC5A-PMT13PN02		
	For slim CPU modules FC4A-D20R*1 (package quantity 2)	FC4A-PMT13PN02		
16-position Terminal Block	For slim CPU modules FC5A-D16RK1/FC4A-D20RK1 (package quantity 2)	FC4A-PMTK16PN02		
	For slim CPU modules FC5A-D16RS1/FC4A-D20RS1 (package quantity 2)	FC4A-PMTS16PN02		
	For slim CPU modules FC5A-D12K1E (package quantity 2)	FC5A-PMTK16EPN02		
	For slim CPU modules FC5A-D12S1E (package quantity 2)	FC5A-PMTS16EPN02		
Analog Voltage Input Cable (1m long) (package quantity 2)		FC4A-PMAC2PN02		
Direct Mounting Strip (package quantity 5)		FC4A-PSP1PN05		
35-mm-wide DIN Rail (1m long)	Aluminium (package quantity 10)	BAA1000PN10		
	Steel (package quantity 10)	BAP1000PN10		
End Clip (package quantity 10)		BNL6PN10		
Computer Link Cable 4C (3m long)		FC2A-KC4C		
Modem Cable 1C (3m long)		FC2A-KM1C		
User Communication Cable 1C (2.4m long)		FC2A-KP1C		
USB Maintenance Cable (2m long, USB-mini B)		HG9Z-XCM42		
Panel Mount Extension Cable (1m long, USB-mini B)		HG9Z-XCE21		
O/I Communication Cable 1C (5m long) for connecting HG1F to MicroSmart port 1 and 2 (RS232C)		FC4A-KC1C		
O/I Communication Cable (3m long) for connecting HG1F to MicroSmart port 2 (RS232C)		HG9Z-XC183		
O/I Communication Cable 2C (5m long) for connecting HG2F/3F/4F to MicroSmart port 1 and 2 (RS232C)		FC4A-KC2C		
O/I Communication Cable (5m long) for connecting HG2F/3F/4F to MicroSmart port 2 (RS232C)		HG9Z-3C125		
O/I Communication Cable 1C (2.4m long) for connecting HG2G/3G to MicroSmart port 1 and 2 (RS232C)		FC2A-KP1C		
O/I Communication Cable 1C (5m long) for connecting HG2G/3G to MicroSmart port 1 and 2 (RS232C)		HG9Z-XC275		
O/I Communication Cable 1C (5m long) for connecting HG3G D-sub pin to MicroSmart port 1 and 2 (RS232C)		HG9Z-XC295		
I/O Terminal Cable	20-wire	Shielded	0.5m	FC9Z-H050A20
			1m	FC9Z-H100A20
			2m	FC9Z-H200A20
		Non-shielded	3m	FC9Z-H300A20
			0.5m	FC9Z-H050B20
			1m	FC9Z-H100B20
	26-wire	Shielded	2m	FC9Z-H200B20
			3m	FC9Z-H300B20
			0.5m	FC9Z-H050A26
		Non-shielded	1m	FC9Z-H100A26
			2m	FC9Z-H200A26
			3m	FC9Z-H300A26
User's Manual * (English)	MicroSmart User's Manual (FC5A) Automation Organizer	Basic & Advanced	FC9Y-B1138	
		Web Server CPU Module	FC9Y-B1278	
		PID Module	FC9Y-B1283	

*MicroSmart User's manual and manuals below (applicable to Automation Organizer) can be downloaded from <http://www.idec.com/japan/ao/>

- FC5A MicroSmart User's Manual Basic/Advanced/Web Server CPU module/PID module: Japanese, English, Chinese, German
- FC4A MicroSmart User's Manual: Japanese, English, Chinese, German, Spanish
- FC5A MicroSmart User's Manual (applicable to WindLDR V.5): Japanese, English, Chinese, German, Spanish
- FC4A MicroSmart User's Manual (applicable to WindLDR V.5): Japanese, English, Chinese, German, Spanish

Specifications (CPU Modules)

• Slim Type

Type No.	FC5A-D12K1E FC5A-D12S1E	FC5A-D16RK1 FC5A-D16RS1	FC5A-D32K3 FC5A-D32S3	FC4A-D20K3 FC4A-D20S3	FC4A-D20RK1 FC4A-D20RS1	FC4A-D40K3 FC4A-D40S3
Rated Power Voltage	24V DC					
Allowable Voltage Range	20.4 to 26.4V DC (including ripple)					
Maximum Input Current	700 mA (26.4V DC) *1			560 mA (26.4V DC) *1	700 mA (26.4V DC) *1	
Maximum Power Consumption	19W (26.4V DC) *1			14W (26.4V DC) *1	17W (26.4V DC) *1	
Allowable Momentary Power Interruption	10 ms (at 24V DC)					
Dielectric Strength	Between power and \oplus terminals: 500V AC, 1 minute Between I/O and \oplus terminals: 500V AC, 1 minute					
Insulation Resistance	Between power and \oplus terminals: 10 M Ω minimum (500V DC megger) Between I/O and \oplus terminals: 10 M Ω minimum (500V DC megger)					
Noise Resistance	DC power terminals: 1.0 kV, 50 ns to 1 μ s I/O terminals (coupling clamp): 1.5 kV, 50 ns to 1 μ s					
Inrush Current	50A maximum (24V DC)					
Power Supply Wire	UL1015, AWG22, UL1007 AWG18					
Operating Temperature	0 to 55°C					
Storage Temperature	-25 to +70°C (no freezing)					
Relative Humidity	Level RH1 (IEC61131-2), 10 to 95% (no condensation)					
Altitude	Operation: 0 to 2,000m, Transport: 0 to 3,000m					
Pollution Degree	2 (IEC60664-1)					
Corrosion Immunity	Free from corrosive gases					
Degree of Protection	IP20 (IEC60529)					
Grounding Wire	UL1015, AWG22, UL1007, AWG18					
Vibration Resistance	When mounted on a DIN rail or panel surface: 5 to 8.4 Hz amplitude 3.5 mm, 8.4 to 150 Hz acceleration 9.8 m/s ² (1G), 2 hours per axis on each of three mutually perpendicular axes (IEC61131-2)					
Shock Resistance	147 m/s ² (15G), 11 ms duration, 3 shocks per axis on three mutually perpendicular axes (IEC61131-2)					
Weight	200g	230g	190g	140g	185g	180g

*1: CPU module + 7 I/O modules

• All-in-One Type

Type No.	FC5A-C10R2 FC5A-C10R2C FC5A-C10R2D	FC5A-C16R2 FC5A-C16R2C FC5A-C16R2D	FC5A-C24R2 FC5A-C24R2C FC5A-C24R2D	FC4A-C10R2 FC4A-C10R2C	FC4A-C16R2 FC4A-C16R2C	FC4A-C24R2 FC4A-C24R2C
Rated Power Voltage	AC power type: 100 to 240V AC, DC power type: 24V DC, 12V DC					
Allowable Voltage Range	AC power type: 85 to 264V AC, 24V DC power type: 20.4 to 28.8V DC (including ripple), 12V DC type: 10.2 to 18.0V DC					
Rated Power Frequency	AC power type: 50/60 Hz (47 to 63 Hz)					
Maximum Input Current	250 mA (85V AC) 160 mA (24V DC)	300 mA (85V AC) 190 mA (24V DC)	450 mA (85V AC) *2 360 mA (24V DC) *3	250 mA (85V AC) 160 mA (24V DC)	300 mA (85V AC) 190 mA (24V DC)	450 mA (85V AC) *2 360 mA (24V DC) *3
Maximum Power Consumption	AC Power	FC5A-C10R2/FC4A-C10R2: 30VA (264V AC), 20VA (100V AC) *4 FC5A-C16R2/FC4A-C16R2: 31VA (264V AC), 22VA (100V AC) *4 FC5A-C24R2/FC4A-C24R2: 40VA (264V AC), 33VA (100V AC) *2				
	DC Power	FC5A-C10R2C/FC4A-C10R2C: 3.9W (24V DC) *5 FC5A-C16R2C/FC4A-C16R2C: 4.6W (24V DC) *5 FC5A-C24R2C/FC4A-C24R2C: 8.7W (24V DC) *3				
Allowable Momentary Power Interruption	10 ms (rated power voltage)					
Dielectric Strength	Between power and \oplus or \ominus terminals: 1,500V AC, 1 minute Between I/O and \oplus or \ominus terminals: 1,500V AC, 1 minute					
Insulation Resistance	Between power and \oplus or \ominus terminals: 10 M Ω minimum (500V DC megger) Between I/O and \oplus or \ominus terminals: 10 M Ω minimum (500V DC megger)					
Noise Resistance	AC power terminals: 1.5 kV, 50 ns to 1 μ s DC power terminals: 1.0 kV, 50 ns to 1 μ s I/O terminals (coupling clamp): 1.5 kV, 50 ns to 1 μ s					
Inrush Current	FC5A-C10R2/FC5A-C10R2C/FC5A-C16R2/ FC5A-C16R2C: 35A FC5A-C10R2D/FC5A-C16R2D: 20A		FC5A-C24R2/ FC5A-C24R2C: 40A FC5A-C24R2D: 20A	35A		40A
Power Supply Wire	UL1015 AWG22, UL1007 AWG18					
Operating Temperature	0 to 55°C					
Storage Temperature	-25 to +70°C (no freezing)					
Relative Humidity	Level RH1 (IEC61131-2), 10 to 95% (no condensation)					
Altitude	Operation: 0 to 2,000m, Transport: 0 to 3,000m					
Pollution Degree	2 (IEC60664-1)					
Corrosion Immunity	Free from corrosive gases					
Degree of Protection	IP20 (IEC60529)					
Ground	Ground resistance 100 Ω (max.)					
Grounding Wire	UL1007, AWG16					
Vibration Resistance	When mounted on a DIN rail or panel surface: 5 to 8.4 Hz amplitude 3.5 mm, 8.4 to 150 Hz acceleration 9.8 m/s ² (1G), 2 hours per axis on each of three mutually perpendicular axes (IEC61131-2)					
Shock Resistance	147 m/s ² (15G), 11 ms duration, 3 shocks per axis on three mutually perpendicular axes (IEC61131-2)					
Weight	AC type: 230g DC type: 240g	AC type: 250g DC type: 260g	AC type: 305g DC type: 310g	AC type: 230g DC type: 240g	AC type: 250g DC type: 260g	AC type: 305g DC type: 310g

*2: CPU module (including 250 mA sensor power) + 4 I/O modules

*3: CPU module + 4 I/O modules

*4: CPU module (including 250 mA sensor power)

*5: CPU module

• Slim Type Function Specifications

Type No.	FC5A-D12K1E FC5A-D12S1E		FC5A-D16R1 FC5A-D16RS1		FC5A-D32K3 FC5A-D32S3		FC4A-D20K3 FC4A-D20S3		FC4A-D20R1 FC4A-D20RS1		FC4A-D40K3 FC4A-D40S3		
Control System	Stored program system												
Instruction Words	42 basic						35 basic						
	152 advanced			126 advanced		130 advanced		53 advanced		72 advanced			
Program Capacity *1	127.8 KB (21,300 steps)			62.4 KB (10,400 steps)			27 KB (4,500 steps)		31.2 KB (5,200 steps) *2				
User Program Storage	Flash ROM (10,000 times rewritable)			EEPROM (10,000 times rewritable)									
Processing Time	Basic Instruction		83 μ s (1,000 steps)						1.65 ms (1,000 steps)				
	END Processing *3		0.35 ms						0.64 ms				
Expandable I/O Modules	7 modules + additional 8 modules using the expansion interface module						7 modules						
I/O Points	Input	8	Expansion: 224	8	Expansion: 224	16	Expansion: 224	12	Expansion: 128	12	Expansion: 224	24	Expansion: 224
	Output	4	Additional: 256	8	Additional: 256	16	Additional: 256	8	8	8	16	16	24
Internal Relay	2,048 points						1,024 points						
Shift Register	256 points						128 points						
Data Register	42,000 points			42,000 points *4			1,300 points						
Expansion Data Register	6,000 points						—		6,000 points				
Counter	256 points						100 points						
Timer (1-sec, 100-ms, 10-ms, 1-ms)	256 points						100 points						
RAM Backup	Backup Data												
	Backup Duration												
	Battery												
	Charging Time												
	Battery Life												
	Replaceability												
Self-diagnostic Function	Power failure, watchdog timer, data link connection, user program ROM sum check, timer/counter preset value sum check, user program RAM sum check, keep data, user program syntax, user program writing, CPU module, clock IC, I/O bus initialize, user program execution												
Input Filter	Without filter, 3 to 15 ms (selectable in increments of 1 ms)												
Catch Input/Interrupt Input	Four inputs (I2 and I5)			Minimum turn on pulse width: 40 μ s maximum Minimum turn off pulse width: 150 μ s maximum Minimum turn on pulse width: 5 μ s maximum Minimum turn off pulse width: 5 μ s maximum			Four inputs (I2 through I5) Minimum turn on pulse width: 40 μ s maximum Minimum turn off pulse width: 150 μ s maximum						
	(I3 and I4)												
High-speed Counter	Maximum Counting Frequency and High-speed Counter Points		Total 4 points			Single/two-phase selectable: 100 kHz (2 points) Single-phase: 100 kHz (2 points)			Total 4 points				
	Counting Range		0 to 4,294,967,295 (32 bits)			0 to 65,535 (16 bits)							
	Operation Mode		Rotary encoder mode and adding counter mode										
Analog Potentiometer	Quantity		1 point										
	Data Range		0 to 255										
Analog Voltage Input	Quantity		1 point										
	Input Voltage Range		0 to 10V DC										
	Input Impedance		Approx. 100 k Ω										
	Data Range		0 to 255 (8 bits)										
Pulse Output	Quantity		3 points			2 points		3 points		2 points			
	Maximum Frequency		100 kHz			20 kHz							
Ethernet Port	Ethernet Specifications		Electrical Characteristics: Complies with IEEE802.3 Transmission Speed: 10BASE-T/100BASE-TX										
	Ethernet Interface		RJ45										
	User Web Page Area		1 MB										
	Compliant Browser		Internet Explorer 7 and 8, Firefox 3										
	Protocol		Data Link Layer: IP, ARP Network Layer: UDP, TCP, ICMP Application Layer: SMTP, DHCP, HTTP, NBNS, DNS, SNTF										
	Function (see table next page)		Web server, Send email, PING, Maintenance communication server, Modbus TCP server/client, User communication server/client, SNTF										
Port 1	USB mini-B (CDC class) Maintenance Communication *5			RS232C – maintenance communication, user communications, Modbus slave ASCII/RTU communication (FC5A only)									
Port 2 Communication Adapter/Module (option) *6	Possible												
Clock Cartridge (option)	Possible												
Memory Cartridge (option)	Possible												
HMI Module (option)	Possible												

Note: The maximum number of relay outputs that can be turned on simultaneously is 54 including those on the CPU module.

Modem communication not possible on FC5A-D12K1E/D12S1E modules.

*1: 1 step equals 6 bytes.

*2: Expandable up to 62.4 KB when a memory cartridge is used.

*3: Not including expansion I/O service time, clock function processing time, data link processing time, and interrupt processing time.

*4: Extra data registers D10000 through D49999 are enabled using WinLDR Function Area Settings, then run-time program download cannot be used.

*5: Maintenance communication (change monitor device values, upload/download user programs, download system program)

*6: Maintenance communication, user communication, modem communication, data link, Modbus ASCII/RTU master/slave communication (FC5A only).

Main Features	Maintenance Communication Server	Downloading, uploading, and monitoring the user program using WindLDR via Ethernet
	TCP server	8 connections maximum. Each connection can be configured as Modbus TCP server, user communication server, or maintenance communication server.
	TCP Client	3 connections maximum. Each connection can be configured as Modbus TCP client or user communication client.
	Aquire Current Time from SNTP Server	Timezone can be specified.
	Sending email	Send emails containg register data. Number of emails: 255 To address: 512 characters maximum (Note 1) cc address: 512 characters maximum (Note 1) Subject :256 characters maximum Body: 1,500 characters maximum Supported encoding: ASCII, ISO-2022-JP, GB2312, ISO-8859-1, UTF-8 Note 1: If the email address length is 40 characters, 12 email addresses can be configured.
	Web Server	Monitoring PLC status and data register values using web browser. User web page area: 1 MB Authentication: Basic Authentication Compliant browser: Internet Explorer 7 and 8, Firefox 3
	PING	Number of remote hosts can be registered: 255

•All-in-One Type Function Specifications

Type No.	FC5A-C10R2 FC5A-C10R2C FC5A-C10R2D	FC5A-C16R2 FC5A-C16R2C FC5A-C16R2D	FC5A-C24R2 FC5A-C24R2C FC5A-C24R2D	FC4A-C10R2 FC4A-C10R2C	FC4A-C16R2 FC4A-C16R2C	FC4A-C24R2 FC4A-C24R2C			
Control System	Stored program system								
Instruction Words	42 basic			35 basic					
	103 advanced	103 advanced	115 advanced	38 advanced	40 advanced	48 advanced			
Program Capacity *1	13.8 KB (2,300 steps)	27 KB (4,500 steps)	54 KB (9,000 steps)	4.8 KB (800 steps)	15 KB (2,500 steps)	27 KB (4,500 steps)			
User Program Storage	EEPROM (10,000 times rewritable)								
Processing Time	Basic Instruction 1.16 ms (1,000 steps)			1.65 ms (1,000 steps)					
	END Processing *2 0.64 ms			0.64 ms					
Expandable I/O Module	—		4 modules	—		4 modules			
I/O Points	Input	6	9	14	Expansion: 64	6	9	14	Expansion:
	Output	4	7	10	*3	4	7	10	64
Internal Relay	2,048 points			256 points			1,024 points		
Shift Register	128 points			64 points			128 points		
Data Register	2,000 points			400 points			1,300 points		
Expansion Data Register	—			—			—		
Counter	256 points			32 points			100 points		
Timer (1-sec, 100-ms, 10-ms, 1-ms)	256 points			32 points			100 points		
RAM Backup	Backup Data	Internal relay, shift register, counter, data register							
	Backup Duration	Approx. 30 days (typical) at 25°C after backup battery fully charged							
	Battery	Lithium secondary battery							
	Charging Time	Approx. 15 hours for charging from 0% to 90% of full charge							
	Battery Life	5 years in cycles of 9-hours charging and 15-hours discharging							
	Replaceability	Not possible to replace battery							
Self-diagnostic Function	Power failure, watchdog timer, data link connection, user program EEPROM sum check, timer/counter preset value sum check, user program RAM sum check, keep data, user program syntax, user program writing, CPU module, clock IC, I/O bus initialize, user program execution								
Input Filter	Without filter, 3 to 15 ms (selectable in increments of 1 ms)								
Catch Input/Interrupt Input	Four inputs (I2 through I5) Minimum turn on pulse width: 40 μs maximum Minimum turn off pulse width: 150 μs maximum								
High-speed Counter	Maximum Counting Frequency and High-speed Counter Points	Total 4 points Single/two-phase selectable: 50 kHz (1 point) Single-phase: 5 kHz (3 points)			Total 4 points Single/two-phase selectable: 20 kHz (1 point) Single-phase: 5 kHz (3 points)				
	Counting Range	0 to 65,535 (16 bits)							
	Operation Mode	Rotary encoder mode and adding counter mode							
	Quantity	1 point		2 points		1 point		2 points	
Analog Potentiometer	Quantity	1 point		2 points		1 point		2 points	
	Data Range	0 to 255							
Analog Voltage Input	Quantity								
	Input Voltage Range								
	Input Impedance	—							
	Data Range								
Pulse Output	Quantity								
	Max. Frequency	—							
Sensor Power Supply (AC Power Type Only)	Output Voltage/Current	24V DC (+10% to -15%), 250 mA							
	Overload Detection	Not available							
	Isolation	Isolated from the internal circuit							
Port 1	RS232C – maintenance communication, user communications, Modbus ASCII/RTU slave communication (FC5A only)								
Port 2 Communication Adapter (option) *4	Possible	Possible	Possible	—	Possible	Possible			
Clock Cartridge (option)	Possible	Possible	Possible	Possible	Possible	Possible			
Memory Cartridge (option)	Possible	Possible	Possible	Possible	Possible	Possible			
HMI Module (option)	Possible	Possible	Possible	Possible	Possible	Possible			

*1: 1 step equals 6 bytes.

*2: Not including expansion I/O service time, clock function processing time, data link processing time, and interrupt processing time.

*3: Expansion modules cannot be connected to FC5A-C24R2D.

*4: Maintenance communication, user communication, Modem communication, data link, Modbus ASCII/RTU master/slave communication (FC5A only).

Note: The maximum number of relay outputs that can be turned on simultaneously is 33 including those on the CPU module.

•Communication Port (Port 1) Specifications

CPU Module	FC5A-D12K1E/D12S1E	Slim CPU	All-in-One CPU
Standards	USB 2.0	EIA RS232C	
Maximum Baud Rate	USB 2.0	FC5A: 57,600 bps (maintenance communication) FC4A: 19,200 bps (maintenance communication)	
Cable	HG9Z-XCM42, HG9Z-XCE21	FC2A-KC4C, FC2A-KP1C, FC4A-KC1C, FC4A-KC2C	
Isolation between Internal Circuit and Communication Port	Not isolated	Not isolated	

• Slim Type Input Specifications

Type No.	FC5A-D12K1E FC5A-D12S1E	—	FC5A-D16RK1 FC5A-D16RS1	—	FC5A-D32K3 FC5A-D32S3	—
	—	FC4A-D20K3 FC4A-D20S3	—	FC4A-D20RK1 FC4A-D20RS1	—	FC4A-D40K3 FC4A-D40S3
Input Points	8 (8/1 common)	12 (12/1 common)	8 (8/1 common)	12 (12/1 common)	16 (8/1 common)	24 (12/1 common)
Rated Input Voltage	24V DC sink/source input signal					
Input Voltage Range	20.4 to 26.4V DC					
Rated Input Current	FC5A I0, I1, I3, I4, I6, I7: 4.5 mA/point (24V DC) I2, I5, I10 to I17: 7 mA/point (24V DC) FC4A I0, I1, I6, I7: 5 mA/point (24V DC) I2 to I5, I10 to I27: 7 mA/point (24V DC)					
Input Impedance	FC5A I0, I1, I3, I4, I6, I7: 4.9 kΩ I2, I5, I10 to I17: 3.4 kΩ FC4A I0, I1, I6, I7: 5.7 kΩ I2 to I5, I10 to I27: 3.4 kΩ					
Turn ON Time	FC5A I0, I1, I3, I4, I6, I7: 5 μs + filter value I2 and I5: 35 μs + filter value I10 to I17: 40 μs + filter value FC4A I0, I1, I6, I7: 35 μs + filter value I2 to I5: 35 μs + filter value I10 to I27: 40 μs + filter value					
Turn OFF Time	FC5A I0, I1, I3, I4, I6, I7: 5 μs + filter value I2 and I5: 150 μs + filter value I10 to I17: 150 μs + filter value FC4A I0, I1, I6, I7: 45 μs + filter value I2 to I5: 150 μs + filter value I10 to I27: 150 μs + filter value					
Connector	On Mother Board	MC1.5/16-G-3.81BK (Phoenix Contact)	FL26A2MA (Oki Electric Cable)	MC1.5/13-G-3.81BK (Phoenix Contact)	FL26A2MA (Oki Electric Cable)	
	Insertion Durability	100 times minimum				
Isolation	Between input terminals: Optocoupler isolated Internal circuit: Not isolated					
Input Type	Type 1 (IEC61131-2)					
External Load for I/O Interconnection	Not needed					
Single Determination Method	Static					
Effect of Improper Input Connection	Both sinking and sourcing input signals can be connected, therefore reverse connection does not cause permanent damage. If any input exceeding the rated value is applied, permanent damage may be caused.					
Cable Length	3m in compliance with electromagnetic immunity					

• All-in-One Type Input Specifications

Type No.	FC5A-C10R2 FC5A-C10R2C	FC5A-C16R2 FC5A-C16R2C	FC5A-C24R2 FC5A-C24R2C	FC5A-C10R2D	FC5A-C16R2D	FC5A-C24R2D
	FC4A-C10R2 FC4A-C10R2C	FC4A-C16R2 FC4A-C16R2C	FC4A-C24R2 FC4A-C24R2C	—	—	—
Input Points	6 (6/1 common)	9 (9/1 common)	14 (14/1 common)	6 (6/1 common)	9 (9/1 common)	14 (14/1 common)
Rated Input Voltage	24V DC sink/source input signal			12V DC sink/source input signal		
Input Voltage Range	20.4 to 28.8V DC			10.2 to 18.0V DC		
Rated Input Current	FC5A I0 and I1: 6.4 mA/point I2 to I7, I10 to I15: 7 mA/point (24V DC) FC4A I0 and I1: 11 mA I2 to I7, I10 to I15: 7 mA/point (24V DC)			I0 and I1: 6 mA I2 to I7, I10 to I15: 6 mA		
Input Impedance	FC5A I0 and I1: 3.7 kΩ I2 to I7, I10 to I15: 3.4 kΩ FC4A I0 and I1: 2.1 kΩ I2 to I7, I10 to I15: 3.4 kΩ			I0 and I1: 1.8 kΩ I2 to I7, I10 to I15: 2.0 kΩ		
Turn ON Time	FC5A I0 and I1: 2 μs + filter value I2 to I5: 35 μs + filter value I6, I7, I10 to I15: 40 μs + filter value FC4A I0 and I1: 35 μs + filter value I2 to I5: 35 μs + filter value I6, I7, I10 to I15: 40 μs + filter value			I0 and I1: 2 μs + filter value I2 to I5: 35 μs + filter value I6, I7, I10 to I15: 40 μs + filter value		
Turn OFF Time	FC5A I0 and I1: 16 μs + filter value I2 to I5: 150 μs + filter value I6, I7, I10 to I15: 150 μs + filter value FC4A I0 and I1: 45 μs + filter value I2 to I5: 150 μs + filter value I6, I7, I10 to I15: 150 μs + filter value			I0 and I1: 16 μs + filter value I2 to I5: 150 μs + filter value I6, I7, I10 to I15: 150 μs + filter value		
Isolation	Between input terminals: Optocoupler isolated Internal circuit: Not isolated					
Input Type	Type 1 (IEC61131-2)					
External Load for I/O Interconnection	Not needed					
Single Determination Method	Static					
Effect of Improper Input Connection	Both sinking and sourcing input signals can be connected, therefore reverse connection does not cause permanent damage. If any input exceeding the rated value is applied, permanent damage may be caused.					
Cable Length	3m in compliance with electromagnetic immunity					

•Transistor Sink and Source Output Specifications

Type No.	FC5A-D12K1E FC5A-D12S1E	—	FC5A-D16RK1 FC5A-D16RS1	FC5A-D32K3 FC5A-D32S3
	—	FC4A-D20RK1 FC4A-D20RS1	—	FC4A-D40K3 FC4A-D40S3
Transistor Output Points	4 (4/1 common)	2 (2/1 common)	2 (2/1 common)	16 (8/1 common)
Output Type	Transistor Sink	FC5A-D12K1E/D16RK1/D32K3 FC4A-D20K3/D20RK1/D40K3		
	Transistor Source	FC5A-D12S1E/D16RS1/D32S3 FC4A-D20S3/D20RS1/D40S3		
Rated Load Voltage	24V DC			
Operating Load Voltage Range	20.4 to 28.8V DC			
Rated Load Current	0.3A per output point			
Maximum Load Current	1A per common			
Voltage Drop (ON Voltage)	1V maximum (voltage between COM and output terminals when output is on)			
Inrush Current	1A			
Leakage Current	0.1 mA maximum			
Clamping Voltage	39V±1V			
Maximum Lamp Load	8W			
Inductive Load	L/R = 10 ms (28.8V DC, 1 Hz)			
External Current Draw	Sink output: 100 mA maximum, 24V DC (power voltage at the +V terminal) Source output: 100 mA maximum, 24V DC (power voltage at the -V terminal)			
Isolation	Between output terminal and Internal circuit: Photocoupler isolated Between output terminals: Not isolated			
Connector on Mother Board	MC1.5/16-G-3.81BK (Phoenix Contact)	FL26A2MA (Oki Electric Cable)	MC1.5/16-G-3.81BK (Phoenix Contact)	FL26A2MA (Oki Electric Cable)
Connector Insertion/ Removal Durability	100 times minimum			
Output Delay	Turn ON Time	FC5A Q0 to Q2:	5 μs max.	
		Q3 to Q7, Q10 to Q17:	300 μs max.	
	Turn OFF Time	FC4A Q0, Q1:	5 μs max.	
		Q2 to Q7, Q10 to Q17:	300 μs max.	
Output Delay	Turn ON Time	FC5A Q0 to Q2:	5 μs max.	
		Q3 to Q7, Q10 to Q17:	300 μs max.	
	Turn OFF Time	FC4A Q0, Q1:	5 μs max.	
		Q2 to Q7, Q10 to Q17:	300 μs max.	

•Relay Output Specifications

Type No.	FC5A-C10R2 FC5A-C10R2C FC5A-C10R2D	FC5A-C16R2 FC5A-C16R2C FC5A-C16R2D	FC5A-C24R2 FC5A-C24R2C FC5A-C24R2D	FC5A-D16RK1 FC5A-D16RS1	
	FC4A-C10R2 FC4A-C10R2C	FC4A-C16R2 FC4A-C16R2C	FC4A-C24R2 FC4A-C24R2C	FC4A-D20RK1 FC4A-D20RS1	
Relay Output Points	4	7	10	6	
Output Points per Com- mon Line	COM0	3	4	—	
	COM1	1	2	3	
	COM2	—	1	1	2
	COM3	—	—	1	1
Output Type	1NO				
Maximum Load Current	2A per point 8A per common line				
Minimum Switching Load	1 mA/ 5V DC (reference value)				
Initial Contact Resistance	30 mΩ maximum				
Electrical Life	100,000 operations minimum (rated load 1,800 operations/hour)				
Mechanical Life	20,000,000 operations minimum (no load 18,000 operations/hour)				
Rated Load	240V AC/2A (resistive load, inductive load $\cos \phi = 0.4$) 30V DC/2A (resistive load, inductive load L/R = 7 ms)				
Dielectric Strength	Between output and \oplus terminals:		1,500V AC, 1 minute		
	Between output terminal and internal circuit:		1,500V AC, 1 minute		
	Between output terminals (COMs):		1,500V AC, 1 minute		
Connector on Mother Board	—			*1	
Connector Insertion/ Removal Durability	—			100 times minimum	

*1: MC1.5/16-G-3.81BK (Phoenix Contact)

• Input Usage Limits

Slim CPU

- FC5A-D16RK1/D16RS1
- FC5A-D12K1E/D12S1E

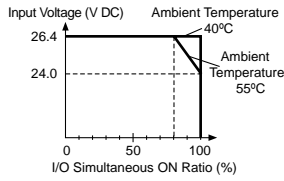

- FC5A-D32K3/D32S3
- FC4A-D40K3/D40S3

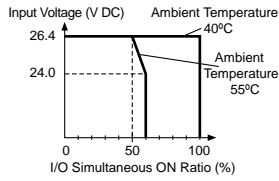

- FC4A-D20K3/D20S3

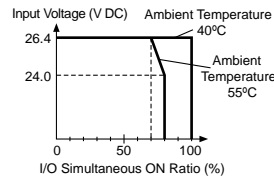

- FC4A-D20RK1/D20RS1

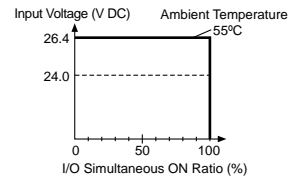

All-in-One CPU

- FC5A-C10R2
- FC5A-C10R2C
- FC4A-C10R2
- FC4A-C10R2C

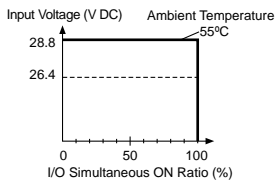

- FC5A-C16R2
- FC5A-C16R2C
- FC4A-C16R2
- FC4A-C16R2C

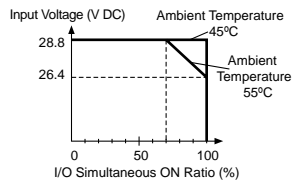

- FC5A-C24R2
- FC5A-C24R2C
- FC4A-C24R2
- FC4A-C24R2C

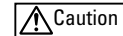
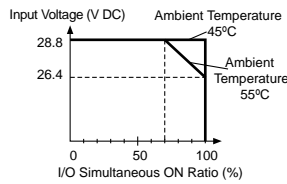

When using at an operating ambient temperature above 40°C, reduce the input voltage or the quantity of I/O points that turn on simultaneously.

• Input Internal Circuit

Slim CPU

FC5A: I0, I1, I3, I4, I6, I7
FC4A: I0, I1, I6, I7

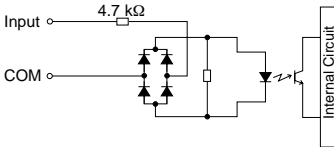

FC5A: I2, I5, I10 to I17
FC4A: I2 to I5, I10 to I27

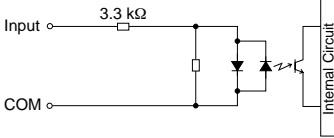

All-in-One CPU

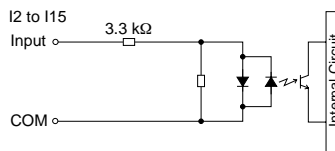
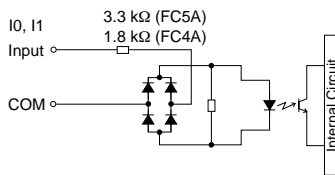

FC5A All-in-One CPU 12V DC Type

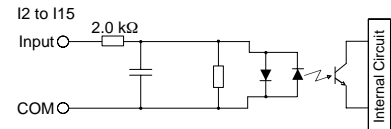
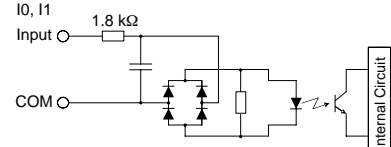

• Output Internal Circuit

Slim CPU

• Sink Output

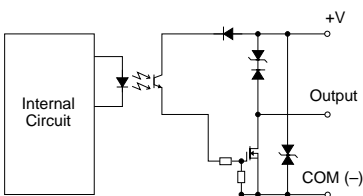

• Source Output

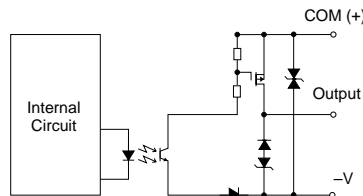

Specifications (Option)

•Communication Adapter/Module Specifications

Type No.	FC4A-PC1 FC4A-HPC1	FC4A-PC2 FC4A-HPC2	FC4A-PC3 FC4A-HPC3
Standards	EIA RS232C	EIA RS485	EIA RS485
Maximum Baud Rate	FC5A: 57,600 bps *1 FC4A: 19,200 bps	FC5A: 57,600 bps *1 FC4A: 19,200 bps	FC5A: 57,600 bps *1 FC4A: 19,200 bps (38,400 bps *2)
Maintenance Communication	Possible	Possible	Possible
User Communication	Possible	Possible *3	Possible *3
Data Link Communication	—	Possible	Possible
Half-duplex Communication	—	Possible	Possible
Maximum Cable Length	Special cable *4	Special cable *5	200m
Quantity of Slave Stations	—	31	31
Isolation between Internal Circuit and Communication Port	Not isolated		
RS485 Cable	Cable		Twisted-pair shielded cable with a minimum core wire of 0.3 mm ²
	Conductor Resistance		85 Ω/km maximum
	Shield Resistance		20 Ω/km maximum

*1: Maximum speed is 115,200 bps for FC5A-D12*1E.

*2: Maximum speed when data link is used.

*3: FC5A (all types), FC4A-D20RK1, FC4A-D20RS1, FC4A-D40K3, FC4A-D40S3

*4: FC2A-KC4C, FC2A-KM1C, FC4A-KC1C, FC4A-KC2C, FC2A-KP1C

*5: FC2A-KP1C

Expansion Serial Communication Module

•General Specifications

(Expansion RS232C Communication Module)

Type No.	FC5A-SIF2
No. of Port	1
Synchronization	Synchronization Start-stop synchronization
Electrical Characteristics	Electrical Characteristics EIA RS232C compliant
Maximum Delay in One Scan	Approx. 4 ms
Operating Temperature	0 to 55°C
Relative Humidity	10 to 95% (no condensation)
Recommended Cable Specifications	Shielded multi-core cable: 24AWG x 6 Dielectric strength: 2,000V AC/min Insulation resistance: 100 MΩ/km
Recommended Cable	KIDU-SB 24 AWG×6C (Nihon Electric Wire & Cable)
Connector on Mother Board	MC1.5/10-G-3.81BK (Phoenix Contact) Applicable terminal block: FC4A-PMT10P
Connector Insertion/Removal Durability	100 times minimum
Isolation from Internal Circuit	Transformer isolated
Quantity of Applicable Expansion RS232C Communication Modules	All-in-One 24-I/O type CPU module: 3 maximum *1 Slim type CPU module: 5 maximum
Internal Current Draw	40 mA (5V/24V DC) *5
Weight	100g

Note: FC5A-SIF2 cannot be connected to FC4A CPU modules.

*1: FC5A All-in-One 24-I/O CPU module cannot use the FC5A-SIF2/SIF4 module in combination with the function modules listed in the table on the left. When using these modules in combination with the FC5A-SIF2/SIF4 module, use the slim type CPU module.

Function Modules	Type No.
Analog Modules	FC4A-L03A1, FC4A-L03AP1, FC4A-J2A1, FC4A-K1A1, FC4A-J4CN1, FC4A-J8C1, FC4A-J8AT1, FC4A-K2C1, FC4A-K4A1
AS-Interface Master Module	FC4A-AS62M

*5: 85 mA (5V DC), 0 mA (24V DC) when the communication module version is lower than V200.

•HMI Module Specifications

Type No.	FC4A-PH1
Power Voltage	5V DC (supplied from the CPU module)
Weight	20g

•Memory Cartridge Specifications

Type No.	FC4A-PM32	FC4A-PM64 *6	FC4A-PM128 *6
Memory Type	EEPROM		
Accessible Memory Capacity	32 KB	64 KB	128 KB
Hardware for Storing Data	CPU Module		
Software for Storing Data	WindLDR		
Quantity of Stored Programs	One user program can be stored on one memory cartridge		

*6: Even when using a large-capacity memory cartridge, the program capacity of the CPU module takes effect, except when using FC4A-D20RK1, FC4A-D20RS1, FC4A-D40K3, and FC4A-D40S3 CPU modules, the program capacity expands to 64KB.

•Clock Cartridge Specifications

Type No.	FC4A-PT1
Accuracy	±30 sec/month (typical) at 25°C
Backup Duration	Approx. 30 days (typical) at 25°C after backup battery fully charged
Battery	Lithium secondary battery
Charging Time	Approx. 10 hours for charging from 0% to 90% of full charge
Replaceability	Not possible to replace battery

(Expansion RS485 Communication Module)

Type No.	FC5A-SIF4
No. of Port	1
Synchronization	Synchronization Start-stop synchronization
Electrical Characteristics	Electrical Characteristics EIA RS485 compliant
Maximum Baud Rate	115,200 bps
Operating Temperature	0 to 55°C
Relative Humidity	10 to 95% (no condensation)
Recommended Cable Specifications	Shielded twisted pair cable: 22 AWG (0.3 mm ² x 2P) Conductor Resistance: 67 MΩ/km maximum (at 20°C)
Connector on Mother Board	MC1.5/10-G-3.81BK (Phoenix Contact) Applicable terminal block: FC4A-PMT10P
Connector Insertion/Removal Durability	100 times minimum
Isolation from Internal Circuit	Transformer isolated
Quantity of Applicable Expansion RS485C Communication Modules	All-in-One 24-I/O type CPU module: 3 maximum *1 Slim type CPU module: 5 maximum
Internal Current Draw	40 mA (5V/24V DC)
Weight	100g

Note: FC5A-SIF4 cannot be connected to FC4A CPU modules.

•Communication Specifications

Type No.	FC5A-SIF2	FC5A-SIF4
Maximum Baud Rate	1,200/2,400/4,800/9,600/19,200/38,400/57,600 (*4)/115,200 (*4)	
Maintenance Communication	Possible *2	
Modbus Communication	Modbus ASCII master Modbus ASCII slave Modbus RTU master Modbus RTU slave	
Data Link	-	0 *3
Max Cable Length	10m	1,200m
Quantity of Slave Stations	1	31

*2: Run-time program download is not possible.

*3: Data Link can be used only on one of the communication ports.

*4: Can be used when the communication module is version V200 or higher.

Specifications (I/O Modules)

•Input Module Specifications

Type No.	FC4A-N08B1	FC4A-N16B1	FC4A-N16B3	FC4A-N32B3	FC4A-N08A11	
Input Points	8 (8/1 common)	16 (16/1 common)		32 (16/1 common)	8 (4/1 common)	
Rated Input Voltage	24V DC sink/source input signal			100 to 120V AC (50/60 Hz)		
Input Voltage Range	20.4 to 28.8V DC			85 to 132V AC		
Rated Input Current	7 mA/point (24V DC)		5 mA/point (24V DC)		17 mA/point (120V AC, 60 Hz)	
Input Impedance	3.4 kΩ		4.4 kΩ		0.8 kΩ (60 Hz)	
ON Voltage	15V minimum			79V minimum		
OFF Voltage	5V maximum			20V maximum		
ON Current	4.2 mA minimum (at 15V DC)		3.2 mA minimum (at 15V DC)		—	
OFF Current	1.2 mA maximum		0.9 mA maximum		—	
Turn ON Time	4 ms			25 ms		
Turn OFF Time	4 ms			30 ms		
Isolation	Between input terminals: Not isolated Internal circuit: Photocoupler isolated			Between input terminals in the same common: Not isolated Between input terminals in different commons: Isolated Between input terminals and internal circuits: Photocoupler isolated		
External Load for I/O Interconnection	Not needed			Not needed		
Single Determination Method	Static			Static		
Effect of Improper Input Connection	Both sink and source input signals can be connected. If any input exceeding the rated value is applied, permanent damage may be caused.			If any input exceeding the rated value is applied, permanent damage may be caused.		
Cable Length	3m in compliance with electromagnetic immunity			—		
Connector on Mother Board	MC1.5/10-G-3.81BK (Phoenix Contact)		FL20A2MA (Oki Electric Cable)		MC1.5/11-G-3.81BK (Phoenix Contact)	
Connector Insertion/Removal Durability	100 times minimum					
Applicable Ferrule	1-wire: AI 0.5-8 WH (Phoenix Contact) 2-wire: AI-TWIN 2x0.5-8 WH (Phoenix Contact)		—		—	
Internal Current Draw	All Inputs ON	25 mA (5V DC)	40 mA (5V DC)	35 mA (5V DC)	65 mA (5V DC)	60 mA (5V DC), 0 mA (24V DC)
	All Inputs OFF	5 mA (5V DC)	5 mA (5V DC)	5 mA (5V DC)	10 mA (5V DC)	30 mA (5V DC), 0 mA (24V DC)
Internal Power Consumption (at 24V DC while all inputs ON)	0.17W	0.27W	0.24W	0.44W	—	
Weight	85g	100g	65g	100g	80g	

•Transistor Output Module Specifications

Type No.	FC4A-T08K1 FC4A-T08S1	FC4A-T16K3 FC4A-T16S3	FC4A-T32K3 FC4A-T32S3
Output Points	8 (8/1 common)	16 (16/1 common)	32 (16/1 common)
Output Type	FC4A-T□K□: Transistor sink output FC4A-T□S□: Transistor source output		
Rated Load Voltage	24V DC		
Operating Load Voltage Range	20.4 to 28.8V DC		
Maximum Load Current	0.3A per point	0.1A per point	
	3A per common	1A per common	
Voltage Drop (ON Voltage)	1V maximum (voltage between COM and output terminals when output is on)		
Inrush Current	1A maximum		
Clamping Voltage	39V±1V		
Maximum Lamp Load	8W		
Inductive Load	L/R = 10 ms (28.8V DC, 1 Hz)		
External Current Draw	FC4A-T□K□: 100 mA maximum, 24V DC (power voltage at the +V terminal) FC4A-T□S□: 100 mA maximum, 24V DC (power voltage at the -V terminal)		
Isolation	Between output terminal and internal circuit: Photocoupler isolated Between output terminals: Not isolated		
Connector on Mother Board	MC1.5/10-G-3.81BK (Phoenix Contact)	FL20A2MA (Oki Electric Cable)	
Connector Insertion/Removal Durability	100 times minimum		
Applicable Ferrule	1-wire: AI 0.5-8 WH (Phoenix Contact) 2-wire: AI-TWIN 2x0.5-8 WH (Phoenix Contact)		
Internal Current Draw	All outputs ON	10 mA (5V DC) 20 mA (24V DC)	20 mA (5V DC) 70 mA (24V DC)
	All outputs OFF	5 mA (5V DC) 0 mA (24V DC)	5 mA (5V DC) 0 mA (24V DC)
Internal Power Consumption (at 24V DC while all outputs ON)	0.55W	1.03W	1.82W
Output Delay	Turn ON Time	300 μs maximum	
	Turn OFF Time	300 μs maximum	
Weight	85g	70g	105g

•Relay Output Module Specifications

Type No.	FC4A-R081	FC4A-R161	
Output Points	8 (4/1 common)	16 (8/1 common)	
Output Type	1NO		
Maximum Load Current	2A per point	8A per common	
	7A per common		
Minimum Switching Load	1 mA/ 5V DC (reference value)		
Initial Contact Resistance	30 mΩ maximum		
Electrical Life	100,000 operations minimum (rated load 1,800 operations/hour)		
Mechanical Life	20,000,000 operations minimum (no load 18,000 operations/hour)		
Rated Load	240V AC/2A (resistive load, inductive load cos φ = 0.4)		
	30V DC/2A (resistive load, inductive load L/R = 7 ms)		
Dielectric Strength	Between output and ⊕ or ⊖ terminals: 1,500V AC, 1 minute		
	Between output terminal and internal circuit: 1,500V AC, 1 minute		
Connector On Mother Board	MC1.5/11-G-3.81BK (Phoenix Contact)	MC1.5/10-G-3.81BK (Phoenix Contact)	
	Connector Insertion/Removal Durability: 100 times minimum		
Applicable Ferrule	1-wire: AI 0.5-8 WH (Phoenix Contact) 2-wire: AI-TWIN 2x0.5-8 WH (Phoenix Contact)		
Internal Current Draw	All outputs ON	30 mA (5V DC) 40 mA (24V DC)	45 mA (5V DC) 75 mA (24V DC)
	All outputs OFF	5 mA (5V DC) 0 mA (24V DC)	5 mA (5V DC) 0 mA (24V DC)
Internal Power Consumption (at 24V DC while all outputs ON)	1.16W	2.10W	
Weight	110g	145g	

•Mixed I/O Module Specifications

Type No.	FC4A-M08BR1	FC4A-M24BR2	
Input Specifications	Input Points	4 (4/1 common)	16 (16/1 common)
	Rated Input Voltage	24V DC sink/source input signal	
	Input Voltage Range	20.4 to 28.8V DC	
	Rated Input Current	7 mA/point (24V DC)	
	Input Impedance	3.4 kΩ	
	ON Voltage	15V minimum	
	OFF Voltage	5V maximum	
	ON Current	4.2 mA minimum (at 15V DC)	
	OFF Current	1.2 mA maximum	
	Turn ON Time	4 ms (24V DC)	
	Turn OFF Time	4 ms (24V DC)	
	Isolation	Between input terminals: Not isolated Internal circuit: Photocoupler isolated	
	External Load for I/O Interconnection	Not needed	
	Signal Determination Method	Static	
Effect of Improper Input Connection	Both sinking and sourcing input signals can be connected. If any input exceeding the rated value is applied, permanent damage may be caused.		
Cable Length	3m in compliance with electromagnetic immunity		
Output Specifications	Output Points	4 (4/1 common)	8 (4/1 common)
	Output Type	1NO	
	Maximum Load Current	2A per point 7A per common	
	Minimum Switching Load	1 mA/ 5V DC (reference value)	
	Initial Contact Resistance	30 mΩ maximum	
	Electrical Life	100,000 operations minimum (rated load 1,800 operations/hour)	
	Mechanical Life	20,000,000 operations minimum (no load 18,000 operations/hour)	
	Rated Load	240V AC/2A (resistive load, inductive load cos φ = 0.4) 30V DC/2A (resistive load, inductive load L/R = 7 ms)	
	Dielectric Strength	Between output and ⊕ or ⊖ terminals: 1,500V AC, 1 minute	
		Between output terminal and internal circuit: 1,500V AC, 1 minute	
Between output terminals (COMs): 1,500V AC, 1 minute			
Connector on Mother Board	MC1.5/11-G-3.81BK (Phoenix Contact)	Input: F6018-17P (Fujicon) Output: F6018-11P (Fujicon)	
Connector Insertion/Removal Durability	100 times minimum	Not removable	
Applicable Ferrule	1-wire: Al 0.5-8 WH (Phoenix Contact), 2-wire: Al-TWIN 2x0.5-8 WH (Phoenix Contact)		
Internal Current Draw	All I/Os ON	25 mA (5V DC), 20 mA (24V DC)	65 mA (5V DC), 45 mA (24V DC)
	All I/Os OFF	5 mA (5V DC), 0 mA (24V DC)	10 mA (5V DC), 0 mA (24V DC)
Internal Power Consumption (at 24V DC while all I/Os are ON)	0.65W	1.52W	
Weight	95g	140g	

•Input Usage Limits

•FC4A-N08B1

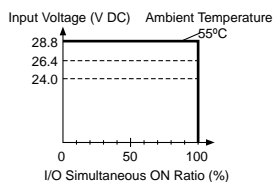

•FC4A-N16B1

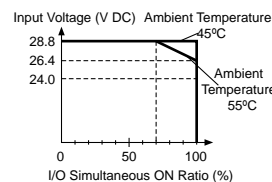

•FC4A-N16B3/N32B3

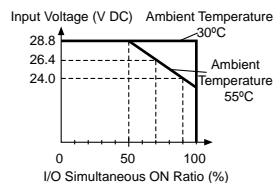

•FC4A-N08A11

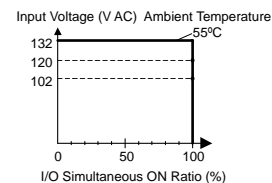

•FC4A-M08BR1

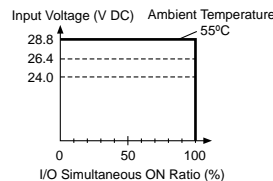

•FC4A-M24BR2

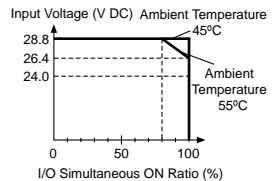

•Input Internal Circuit

•FC4A-N08B1, FC4A-N16B1

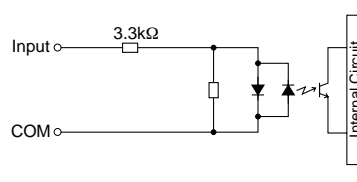

•FC4A-N16B3, FC4A-N32B3

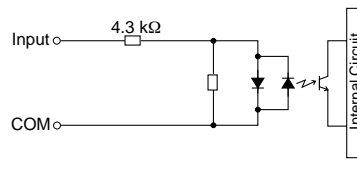

•FC4A-M08BR1, FC4A-M24BR2

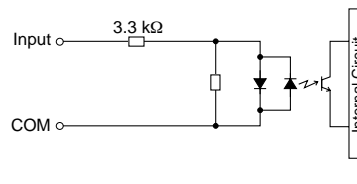

•FC4A-N08A11

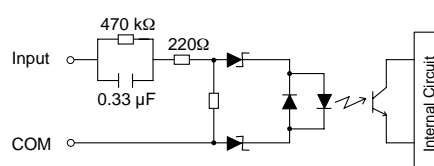

•Output Internal Circuit

•FC4A-T08K1, FC4A-T16K3, FC4A-T32K3

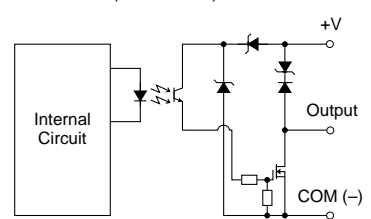

•FC4A-T08S1, FC4A-T16S3, FC4A-T32S3

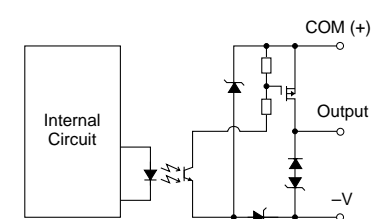

⚠ Caution

When using at an operating ambient temperature above 40°C, reduce the input voltage or the quantity of I/O points that turn on simultaneously.

Specifications (Analog I/O Modules)

• Analog I/O Module Specifications

Type No.	FC4A-L03A1	FC4A-L03AP1	FC4A-J2A1	FC4A-J4CN1	FC4A-J8C1	FC4A-J8AT1	FC4A-K4A1	FC4A-K1A1	FC4A-K2C1
Input Points	2	2	2	4	8	8	—	—	—
Output Points	1	1	—	—	—	—	4	1	2
Power Voltage	24V DC								
Allowable Voltage Range	20.4 to 28.8V DC								
External Current Draw * (24V DC)	45 mA	40 mA	35 mA	55 mA	50 mA	55 mA	130 mA	40 mA	85 mA
Connector on Mother Board	MC1.5/11-G-3.81BK (Phoenix Contact)			MC1.5/10-G-3.81BK (Phoenix Contact)			MC1.5/11-G-3.81BK (Phoenix Contact)		MC1.5/10-G-3.81BK (Phoenix Contact)
Connector Insertion/Removal Durability	100 times minimum								
Applicable Ferrule	1-wire: AI 0.5-8 WH (Phoenix Contact), 2-wire: AI-TWIN 2x0.5-8 WH (Phoenix Contact)								
Internal Power Consumption (5V DC)	50 mA	50 mA	50 mA	50 mA	40 mA	45 mA	65 mA	50 mA	60 mA
Internal Power Consumption (at 24V DC while all I/Os are ON)	0.34W	0.34W	0.34W	0.34W	0.27W	0.30W	0.44W	0.34W	0.40W
Weight	85g	85g	85g	140g	140g	125g	100g	85g	110g

* The external current draw is the value when all the analog inputs are used and the analog output value is at 100%.

• Input Circuit

FC4A-L03A1, FC4A-L03AP1
FC4A-J2A1

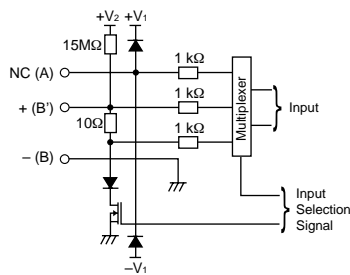

FC4A-J4CN1

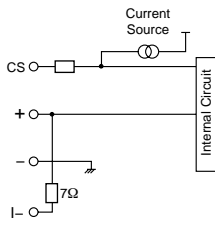

FC4A-J8C1

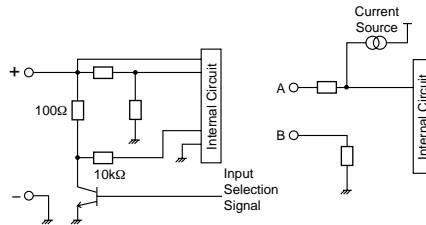

FC4A-J8AT1

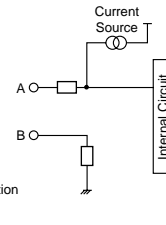

• Analog Input Specifications (1)

Type No.	FC4A-L03A1, FC4A-J2A1		FC4A-L03AP1	
Input Signal Type	Voltage Input 0 to 10V DC	Current Input 4 to 20 mA	Resistance Thermometer Pt100 3-wire type (-100 to 500°C)	Thermocouple Type K (0 to 1,300°C) Type J (0 to 1,200°C) Type T (0 to 400°C)
Input Impedance	1 MΩ minimum	10Ω	1 MΩ minimum	1 MΩ minimum
Input Detection Current	—	—	1.0 mA maximum	—
AD Conversion	Sampling Duration Time	10 ms maximum	20 ms maximum	10 ms maximum
	Sampling Repetition Time	20 ms maximum	40 ms maximum	20 ms maximum
	Total Input System Transfer Time	60 ms + 1 scan time	80 ms + 1 scan time	60 ms + 1 scan time
	Type of Input	Single-ended input	Differential input	
	Operating Mode	Self-scan		
	Conversion Method	Σ Δ type ADC		
Input Error	Maximum Error at 25°C	±0.2% of full scale	±0.2% of full scale plus cold junction compensation error (±4°C maximum)	
	Temperature Coefficient	±0.006% of full scale /°C		
	Repeatability after Stabilization Time	±0.5% of full scale		
	Non-linearity	±0.2% of full scale		
	Maximum Error	±1% of full scale		
Data	Digital Resolution	4096 increments (12 bits)	6,000 increments (14 bits)	Type K: 13,000 increments (14 bits) Type J: 12,000 increments (14 bits) Type T: 4,000 increments (14 bits)
	Input Value of LSB	2.5 mV	4 μA	Type K: 0.1°C Type J: 0.1°C Type T: 0.1°C
	Data Type in Application Program	Default: 0 to 4,095 Optional: -32,768 to 32,767 (selectable for each channel) *1		
	Monotonicity	Yes		
	Input Data Out of Range	Detectable *2		
Noise Resistance	Maximum Temporary Deviation during Electrical Noise Tests	±3% maximum when a 500V clamp voltage is applied to the power supply and I/O lines *3		
	Input Filter	No		
	Recommended Cable for Noise Immunity	Twisted pair shielded cable		—
	Crosstalk	2 LSB maximum		

•Analog Input Specifications (1) (Continued)

Type No.	FC4A-L03A1, FC4A-J2A1		FC4A-L03AP1
Isolation	Between input and power circuit: Isolated		Between input and internal circuit: Photocoupler-isolated
Effect of Improper Input Connection	No damage		
Maximum Permanent Allowed Overload (No Damage)	13V DC	40 mA	—
Selection of Analog Input Signal Type	Using programming software		
Calibration or Verification to Maintain Rated Accuracy	Impossible		

*1: The data processed in the analog I/O module can be linear-converted to a value between -32,768 and 32,767. The optional range designation, and analog I/O data minimum and maximum values can be selected using data registers allocated to analog I/O modules.

*2: When an error is detected, a corresponding error code is stored to a data register allocated to analog I/O operating status.

*3: The accuracy of the thermocouple input is not guaranteed when noise is applied.

•Analog Input Specifications (2)

Type No.	FC4A-J4CN1, FC4A-J8C1		FC4A-J4CN1		FC4A-J8AT1		
Input Signal Type	Voltage Input	Current Input	Thermocouple	Resistance Thermometer	NTC Thermistor	PTC Thermistor	
Input Range	0 to 10V DC	4 to 20 mA	Type K (0 to 1,300°C) Type J (0 to 1,200°C) Type T (0 to 400°C)	Pt100, Pt1000 3-wire type (-100 to 500°C) Ni100, Ni1000 3-wire type (-60 to 180°C)	-50 to 150°C		
Input Impedance	1 MΩ	7 Ω (FC4A-J4CN1) 100 Ω (FC4A-J8C1)	1 MΩ	—	—		
Input Detection Current	—	—	—	0.1 mA	0.1 mA		
AD Conversion	Sampling Duration Time	2 ms maximum					
	Sampling Repetition Time	FC4A-J4CN1: 10 ms maximum FC4A-J8C1: 2 ms maximum	30 ms maximum	10 ms maximum	2 ms × channels		
	Total Input System Transfer Time	FC4A-J4CN1: 50 ms × channels + 1 scan time FC4A-J8C1: 8 ms × channels + 1 scan time	85 ms × channels + 1 scan time	50 ms × channels + 1 scan time	10 ms × channels + 1 scan time		
	Type of Input	Single-ended input					
	Operating Mode	Self-scan					
Conversion Method	Σ Δ type ADC (FC4A-J4CN1), Successive approximation register method (FC4A-J8C1, FC4A-J8AT1)						
Input Error	Maximum Error at 25°C	±0.2% of full scale	±0.2% of full scale +cold junction compensation error (±3°C maximum)	Pt100, Ni100: ±0.4% of full scale Pt1000, Ni1000: ±0.2% of full scale	±0.2% of full scale		
	Cold Junction Compensation Error	—	±3°C maximum	—	—		
	Temperature Coefficient	±0.005% of full scale/°C					
	Repeatability after Stabilization Time	±0.5% of full scale					
	Non-linearity	±0.04% of full scale				Non-linear	
Maximum Error	±1% of full scale						
Data	Digital Resolution	50,000 increments (16 bits)	Type K: Approx. 24,000 increments (15 bits) Type J: Approx. 33,000 increments (15 bits) Type T: Approx. 10,000 increments (14 bits)	Pt100: Approx. 6,400 increments (13 bits) Pt1000: Approx. 64,000 increments (16 bits) Ni100: Approx. 4,700 increments (13 bits) Ni1000: Approx. 47,000 increments (16 bits)	Approx. 4,000 increments (12 bits)		
	Input Value of LSB	0.2 mV	0.32 μA	Type K: 0.058°C Type J: 0.038°C Type T: 0.042°C	Pt100: 0.086°C Pt1000: 0.0086°C Ni100: 0.037°C Ni1000: 0.0037°C	0.05°C	
	Data Type in Application Program	Default: 0 to 50,000 Optional: -32,768 to 32,767 (selectable for each channel) *1			Default: 0 to 4,000 Optional: -32,768 to 32,767 (selectable for each channel) *1 Resistance: 0 to 10,000 Temperature: °C, °F		
	Monotonicity	Yes					
	Input Data Out of Range	Detectable *2					
Noise Resistance	Maximum Temporary Deviation during Electrical Noise Tests	±3% maximum (when a 500V clamp voltage is applied to the power supply and I/O lines)		Not assured	±3% maximum (when a 500V clamp voltage is applied to the power supply and I/O lines)		
	Input Filter	Software					
	Recommended Cable for Noise Immunity	Twisted pair cable		—			
Crosstalk	2 LSB maximum						
Isolation	Between input and power circuit: Isolated		Between input and internal circuit: Optocoupler-isolated				
Effect of Improper Input Connection	No damage						
Maximum Permanent Allowed Overload (No Damage)	11V DC	22 mA DC	—				
Selection of Analog Input Signal Type	Using programming software						
Calibration or Verification to Maintain Rated Accuracy	Impossible						

*1: The data processed in the analog I/O module can be linear-converted to a value between -32,768 and 32,767. The optional range designation, and analog I/O data minimum and maximum values can be selected using data registers allocated to analog I/O modules.

*2: When an error is detected, a corresponding error code is stored to a data register allocated to analog I/O operating status.

• Analog Output Specifications

Type No.		FC4A-K4A1	FC4A-L03A1	FC4A-L03AP1	FC4A-K1A1	FC4A-K2C1	
Output Range	Voltage	0 to 10V DC					-10 to 10V DC
	Current	4 to 20 mA					
Load	Impedance	Voltage output: 1 kΩ minimum Current output: 300Ω maximum					
	Load Type	Resistive load					
DA Conversion	Settling Time	2 ms/ch	10 ms	10 ms	10 ms	1 ms/ch	
	Total Output System Transfer Time	2 ms/ch + 1 scan time	10 ms + 1 scan time	10 ms + 1 scan time	10 ms + 1 scan time	1 ms × channels + 1 scan time	
Output Error	Maximum Error at 25°C	±0.2% of full scale					
	Temperature Coefficient	±0.015% of full scale/°C					±0.005% of full scale/°C
	Repeatability after Stabilization Time	±0.5% of full scale					
	Output Voltage Drop	±1% of full scale					
	Non-linearity	±0.2% of full scale					
	Output Ripple	20 mV maximum					±0.1% of full scale
	Overshoot	0%					
	Total Error	±1% of full scale					
Data	Digital Resolution	4096 increments (12 bits)				50,000 increments (16 bits)	
	Output Value of LSB	Voltage	2.5 mV			0.4 mV	
		Current	4 μA			0.32 μA	
	Data Type in Application Program	Default: 0 to 4,095 (voltage, current)				-25,000 to 25,000 (voltage)	
		Optional: -32,768 to 32,767 (selected for each channel) *1					0 to 50,000 (current)
	Monotonicity	Yes					
Current Loop Open	Undetectable						
Noise Resistance	Maximum Temporary Deviation during Electrical Noise Tests	±3% maximum when a 500V clamp voltage is applied to the power and I/O lines					
	Recommended Cable for Noise Immunity	Twisted pair shielded cable				Twisted pair cable	
	Crosstalk	2LSB maximum	None			2 LSB maximum	
Isolation	Between output and power circuit	Isolated					
	Between output and internal circuit	Photocoupler-isolated					
Effect of Improper Output Connection	No damage						
Selection of Analog Output Signal Type	Using software programming						
Calibration or Verification to Maintain Rated Accuracy	Impossible						

*1: The data processed in the analog I/O module can be linear-converted to a value between -32,768 and 32,767. The optional range designation, and analog I/O data minimum and maximum values can be selected using data registers allocated to analog I/O modules.

Specifications (PID Module)

Type No.		FC5A-F2MR2	FC5A-F2M2
Control Mode	Independent PID Control	Possible	
	Heating/Cooling Control	Possible (overlapping deadband settings available) *	
	Difference Input Temperature Control	Possible *	
	Cascade Control	Possible *	
Input Points		2ch	2ch
Types of Inputs	Thermocouple	K, J, R, S, B, E, T, N, PL-II, C (W/Re5-26) External resistance: 100Ω maximum However, external resistance of B input: 40Ω maximum	
	Resistance Thermometer	Pt100, JPt100, 3-wire type Allowable conductor resistance (per wire): 10Ω maximum	
	Current Input	0 to 20 mA DC, 4 to 20 mA DC Input impedance: 50Ω Maximum permanent allowed overload (no damage): 50 mA maximum	
	Voltage Input	0 to 1V DC Input impedance: 1MΩ minimum Maximum permanent allowed overload (No damage): 5V DC Allowable output impedance: 2 kΩ 0 to 5V DC, 1 to 5V DC, 0 to 10V DC Input impedance: 100kΩ minimum Maximum permanent allowed overload (No damage): 15V DC maximum Allowable output impedance: 100Ω maximum	
AD Conversion	Sampling Duration Time	100 ms	
	Sampling Repetition Time	125 ms	
	Type of Input	Differential input	
	Conversion Method	Σ Δ type ADC	
Maximum Error at 25°C	Thermocouple Input	±0.2% of full scale or ±2°C (4°F), whichever is greater However, R, S inputs: 0 to 200°C (0 to 400°F): ±6°C (12°F) B input: 0 to 300°C (0 to 600°F) Accuracy is not guaranteed. K, J, E, T, N inputs: Less than 0°C (32°F): ±0.4% of full scale	
	Resistance Thermometer Input	±0.1% of full scale or ±1°C (2°F), whichever is greater	
	Voltage/Current Inputs	±0.2% of full scale	
Input Accuracy (at 0 to 55°C)	Thermocouple Input	±0.7% of full scale However, R, S input: 0 to 200°C (0 to 400°F): ±6°C (12°F) B input: 0 to 300°C (0 to 600°F) Accuracy is not guaranteed. K, J, E, T, N inputs: Less than 0°C (32°F): ±0.9% of full scale	
	Resistance Thermometer Input	±0.6% of full scale	
	Voltage/Current Inputs	±0.7% of full scale	
Noise Resistance	Maximum Temporary Deviation during Electrical Noise Tests	Voltage input, current input ±3% maximum when a 500V clamp voltage is applied to the power supply and I/O lines Thermocouple, Resistance Thermometer Not assured	
	Input Filter	None	
	Recommended Cable for Noise Immunity	Twisted pair cable	
	Cross Talk	None	
Isolation		Between input and power circuit: Transformer Isolated Between input and internal circuit: Optocoupler isolated	
Data Accuracy		Maximum error at 25°C±Minimum digital resolution of each input range	
Cold Junction Temperature Compensation Accuracy		±1°C at 0 to 55°C	
Sampling Period		125 ms	
Output Points		2ch	
Output		Relay output 1NO Rated load 5A 250V AC/30V DC (resistive load) 3A 250V AC (inductive load cos φ=0.4) Minimum open/closed load: 10 mA 5V DC Electrical life: 100,000 cycles (at the maximum rating of resistive load)	Non-contact voltage output (for SSR drive) 12V DC±15% Maximum 40 mA (short circuit protected) Leakage current: 0.3 mA maximum
			Analog current output 4 to 20 mA DC Maximum Error: ±0.5% Full Scale at 25°C ±1.0% Full Scale at 55°C Load resistance: 550Ω maximum Analog output digital resolution:1,000 LSB input value: 0.016 mA
Noise Resistance	Maximum Temporary Deviation during Electrical Noise Tests	—	±3% maximum when a 500V clamp voltage is applied to the power supply and I/O lines
	Recommended Cable for Noise Immunity	—	Twisted pair cable
	Cross Talk	—	None
Isolation		Between output and power circuit: Transformer Isolated	Between output and power circuit: Transformer Isolated Between output and internal circuit: Optocoupler isolated
Power Voltage		24V DC (External power), 5V DC (Internal power)	
Allowable Voltage Range		20.4 to 28.8V DC	
External Power Consumption		Approx. 3.5W maximum	
Internal Power Consumption (at 24V DC while all I/Os are on)		65mA (5V DC)	
Connector on Mother Board		Input: F6018-17P (Fujicon)	Output: F6018-11P (Fujicon)
Weight (approx.)		140g	

* Dual channel input is required for one loop control.

•Input Range

Input	Input Range (Digital Resolution)		Input Value of LSB	
Input Type	K	-200 to 1,370°C	-328 to 2,498°F	1°C (°F)
		-200.0 to 400.0°C	-328.0 to 752.0°F	0.1°C (°F)
	J	-200 to 1,000°C	-328 to 1,832°F	1°C (°F)
	R	0 to 1,760°C	32 to 3,200°F	1°C (°F)
	S	0 to 1,760°C	32 to 3,200°F	1°C (°F)
	B	0 to 1,820°C	32 to 3,308°F	1°C (°F)
	E	-200 to 800°C	-328 to 1,472°F	1°C (°F)
	T	-200.0 to 400.0°C	-328.0 to 752.0°F	0.1°C (°F)
	N	-200 to 1,300°C	-328 to 2,372°F	1°C (°F)
	PL-II	0 to 1,390°C	32 to 2,534°F	1°C (°F)
	C (W/Re5-26)	0 to 2,315°C	32 to 4,199°F	1°C (°F)
	Pt100	-200.0 to 850.0°C	-328.0 to 1,562.0°F	0.1°C (°F)
		-200 to 850°C	-328 to 1,562°F	1°C (°F)
	JPt100	-200.0 to 500.0°C	-328.0 to 932.0°F	0.1°C (°F)
		-200 to 500°C	-328 to 932°F	1°C (°F)
	4 to 20mA DC	-2,000 to 10,000 (12,000 increments)		1.333 µA
	0 to 20mA DC	-2,000 to 10,000 (12,000 increments)		1.666 µA
0 to 1V DC	-2,000 to 10,000 (12,000 increments)		0.083 mA	
0 to 5V DC	-2,000 to 10,000 (12,000 increments)		0.416 mA	
1 to 5V DC	-2,000 to 10,000 (12,000 increments)		0.333 mA	
0 to 10V DC	-2,000 to 10,000 (12,000 increments)		0.833 mA	

Expansion Interface Module Specifications

Type No.	FC5A-EXM1M (Expansion Interface Master Module)	FC5A-EXM1S (Expansion Interface Slave Module)	FC5A-EXM2 (Expansion Interface Module)
Rated Power Voltage	—	24V DC (supplied from external power)	24V DC (supplied from external power)
Allowable Voltage Range	—	20.4 to 26.4V DC (including ripple)	20.4 to 26.4V DC (including ripple)
Current Draw (Internal Power/External Power)	Internal power (supplied from CPU module): 90 mA (5V DC) 0 mA (24V DC)	Internal power (supplied from CPU module): 0 mA (5V DC) 0 mA (24V DC) External power: With I/O modules 750 mA (26.4V DC) *1	Internal power (supplied from CPU module): 50 mA (5V DC) 0 mA (24V DC) External power: With I/O modules 750 mA (26.4V DC) *1
Maximum Power Consumption (External Power) *1	—	19W (26.4V DC)	19W (26.4V DC)
Allowable Momentary Power Interruption	—	10 ms minimum (24V DC)	10 ms minimum (24V DC)
I/O Expansion	Between CPU module and expansion interface module Connectable CPU modules: FC5A-D16RK1/D16RS1/D32K3/D32S3/D12K1E/D12S1E Connectable I/O modules: 7 maximum Beyond the expansion interface module Connectable I/O modules: 8 digital I/O modules maximum (AC input modules are not applicable) *2		
Maximum I/O Refresh Time *3	3.6 ms		2.8 ms
Communication between CPU Module and Expansion Interface Module	Asynchronous communication (I/O refresh of I/O modules on both sides of the expansion interface module is asynchronous.)		
Isolation from Internal Circuit	Only communication interface part is isolated		Not isolated
EMC Compliant Cable Length	1m (FC5A-KX1C)		—
Power Supply Connector	Connector on Mother Board	—	MKDSN1.5/3-5.08-BK (Phoenix Contact)
	Connector Insertion/Removal Durability	—	—
Expansion Cable Connector	Connector on Mother Board	FCN-365P024-AU (Fujitsu Component)	—
	Connector Insertion/Removal Durability	100 times minimum	—
Weight	70g	135g	140g

*1: Power consumption by the expansion interface module and eight I/O modules.
 *2: The maximum number of relay outputs that can be turned on simultaneously is 54 points.
 *3: Maximum I/O refresh time of the expansion interface module. D8252 stores the refresh time.

Web Server Unit

• General Specifications

Type No.	FC4A-SX5ES1E
Rated Power Voltage	24V DC
Allowable Voltage Range	20.4 to 26.4V DC
Current Draw	70 mA
Allowable Momentary Power Interruption	10 ms maximum
Dielectric Strength	500V AC, 1 minute
Insulation Resistance	10 MΩ minimum (500V DC megger)
Noise Resistance	DC power terminal: 1.0 kV, 50 ns to 1 μs Ethernet cable: 0.5 kV, 50 ns to 1 μs (coupling clamp)
Inrush Current	4A maximum
Operating Temperature	0 to 55°C
Storage Temperature	-40 to +70°C (no freezing)
Relative Humidity	10 to 95% (no condensation)
Pollution Degree	2 (IEC 60664-1)
Corrosion Immunity	Free from corrosive gases
Degree of Protection	IP20 (IEC60529)
Vibration Resistance	When mounted on a DIN rail: 5 to 8.4 Hz amplitude 3.5 mm 8.4 to 150 Hz acceleration 9.8 m/s ² (1G) 2 hours in each of 3 axes
Shock Resistance	147 m/s ² (15G), 3 shocks each in 3 axes
Weight (approx.)	150g

• Connectable Devices

Programmable Controllers: FC5A, FC4A, FC3A

Operator Interfaces: (RS232C communication with PLC through Ethernet) HG2F, HG2S, HG1F

• Interface Specifications

Communication	RS232C <=> Ethernet conversion function
Ethernet Specifications	Electrical characteristics: Complies with IEEE802.3 Transmission speed: 10BASE-T/100BASE-TX (Not CE compliant) Communication protocol: IP/ICMP/ARP Ethernet protocol: TCP/SMTP/HTTP/Telnet No. of TCP connections: 1
Serial Interface Specifications	Electrical characteristics: EIA RS232C Transmission speed: 9,600 to 115,200 bps Synchronization: Asynchronous Communication protocol: Full duplex Transmission control: RTS/CTS, XON/OFF, None
Connection Method	Ethernet interface: RJ45 Serial interface: Mini DIN 8-pin connector Cable Type No.: FC4A-KC3C
Major Functions	Remote maintenance: Uploading, downloading and monitoring using WindLDR via Ethernet
	Web server: Configure the web server module using Internet Explorer etc. Reading and writing PLC operands using Java applet. Web file area: 512 KB Compliant browser: Internet Explorer 6.0 Netscape Navigator 7.2
	Ethernet user communication: User communication using Ethernet Message transmission: Registered outgoing message 32 message types 63 characters maximum per message 2 email addresses 64 address characters maximum

Option	Utility CD: Configuration file, PLC operand monitor sample programs, sample program configuration instructions, instruction manual (English/German/Spanish/Japanese/Chinese)
--------	--

Instructions

•Basic Instructions

Symbol	Function	Qty of Bytes		
		FC5A Slim Type	FC5A All-in-One Type	FC4A
AND	Series connection of NO contact	4	4	4
AND LOD	Series connection of circuit blocks	4	5	5
ANDN	Series connection of NC contact	4	4	4
BPP	Restores the result of bit logical operation which was saved temporarily	4	2	2
BPS	Saves the result of bit logical operation temporarily	4	5	5
BRD	Reads the result of bit logical operation which was saved temporarily	4	3	3
CC=	Equal to comparison of counter current value	10 to 12	7	7
CC≥	Greater than or equal to comparison of counter current value	10 to 12	7	7
CDP	Dual pulse reversible counter (0 to 65,535)	12 to 14	4	4
CDPD	Double-word dual pulse reversible counter (0 to 4,294,967,295)	12 to 14	4	—
CNT	Adding counter (0 to 65,535)	12 to 14	4	4
CNTD	Double-word adding counter (0 to 4,294,967,295)	12 to 14	4	—
CUD	Up/down selection reversible counter (0 to 65,535)	12 to 14	4	4
CUDD	Double-word up/down selection reversible counter (0 to 4,294,967,295)	12 to 14	4	—
DC=	Equal to comparison of data register value	10 to 14	8	8
DC≥	Greater than or equal to comparison of data register value	10 to 14	8	8
END	Ends a program	4	2	2
JEND	Ends a jump instruction	4	4	4
JMP	Jumps a designated program area	6	4	4
LOD	Stores intermediate results and reads contact status	4	6	6
LODN	Stores intermediate results and reads inverted contact status	4	6	6
MCR	Ends a master control	4	4	4
MCS	Starts a master control	4	4	4
OR	Parallel connection of NO contact	4	4	4
OR LOD	Parallel connection of circuit blocks	4	5	5
ORN	Parallel connection of NC contact	4	4	4
OUT	Outputs the result of bit logical operation	4	6	6
OUTN	Output the inverted result of bit logical operation	4	6	6
RST	Resets output, internal relay, or shift register bit	4	6	6
SET	Sets output, internal relay, or shift register bit	4	6	6
SFR	Forward shift register	10	6	6
SFRN	Reverse shift register	10	6	6
SOTD	Falling-edge differentiation output	4	5	5
SOTU	Rising-edge differentiation output	4	5	5
TIM	Subtracting 100-ms timer (0 to 6553.5 sec)	12 to 14	4	4
TIMO	Subtracting 100-ms off-delay timer (0 to 6553.5 sec)	12 to 14	4	—
TMH	Subtracting 10-ms timer (0 to 655.35 sec)	12 to 14	4	4
TMHO	Subtracting 10-ms off-delay timer (0 to 655.35 sec)	12 to 14	4	—
TML	Subtracting 1-sec timer (0 to 65535 sec)	12 to 14	4	4
TMLO	Subtracting 1-sec off-delay timer (0 to 65535 sec)	12 to 14	4	—
TMS	Subtracting 1-ms timer (0 to 65.535 sec)	12 to 14	4	4
TMSO	Subtracting 1-ms off-delay timer (0 to 65.535 sec)	12 to 14	4	—

•Advanced Instructions

Symbol	Function	Slim Type			All-in-One Type		
		FC5A -D12K1E, D12S1E	—	FC5A -D16RK1, -D16RS1, -D32K3, -D32S3	FC5A -C10R2, C10R2C	FC5A -C16R2, C16R2C	FC5A -C24R2, C24R2C
		—	FC4A -D20K3, -D20S3	FC4A -D20RK1, -D20RS1, -D40K3, -D40S3	FC4A -C10R2, -C10R2C	FC4A -C16R2, -C16R2C	FC4A -C24R2, -C24R2C
NOP	No Operation	x	x	x	x	x	x
MOV	Move	x	x	x	x	x	x
MOVN	Move Not	x	x	x	x	x	x
IMOV	Indirect Move	x	x	x	x	x	x
IMOVN	Indirect Move Not	x	x	x	x	x	x
BMOV	Block Move	x	—	x	*	*	*
IBMV	Indirect Bit Move	x	—	x	*	*	*
IBMVN	Indirect Bit Move Not	x	—	x	*	*	*
NSET	N Data Set	x	—	*	*	*	*
NRS	N Data Repeat Set	x	—	*	*	*	*
XCHG	Exchange	x	—	*	*	*	*
TCCST	Timer/Counter Current Value Store	x	—	*	*	*	*
CMP=	Compare Equal To	x	x	x	x	x	x
CMP<>	Compare Unequal To	x	x	x	x	x	x
CMP<	Compare Less Than	x	x	x	x	x	x
CMP>	Compare Greater Than	x	x	x	x	x	x
CMP<=	Compare Less Than or Equal To	x	x	x	x	x	x
CMP>=	Compare Greater Than or Equal To	x	x	x	x	x	x
ICMP>=	Interval Compare Greater Than or Equal to	x	—	x	*	*	*
LC=	Load Compare Equal To	x	—	*	*	*	*
LC<>	Load Compare Unequal To	x	—	*	*	*	*
LC<	Load Compare Less Than	x	—	*	*	*	*
LC>	Load Compare Greater Than	x	—	*	*	*	*
LC<=	Load Compare Less Than or Equal To	x	—	*	*	*	*
LC>=	Load Compare Greater Than or Equal To	x	—	*	*	*	*
ADD	Addition	x	x	x	x	x	x
SUB	Subtraction	x	x	x	x	x	x
MUL	Multiplication	x	x	x	x	x	x
DIV	Division	x	x	x	x	x	x
INC	Increment	x	—	*	*	*	*
DEC	Decrement	x	—	*	*	*	*
ROOT	Root	x	x	x	x	x	x
SUM	Sum	x	—	*	*	*	*
RNDM	Random	x	—	*	*	*	*
ANDW	AND Word	x	x	x	x	x	x
ORW	OR Word	x	x	x	x	x	x
XORW	Exclusive OR Word	x	x	x	x	x	x
SFTL	Shift Left	x	x	x	x	x	x
SFTR	Shift Right	x	x	x	x	x	x
BCDLS	BCD Left Shift	x	—	x	*	*	*
WSFT	Word Shift	x	—	x	*	*	*
ROTL	Rotate Left	x	x	x	x	x	x
ROTR	Rotate Right	x	x	x	x	x	x
HTOB	Hex to BCD	x	x	x	x	x	x
BTOH	BCD to Hex	x	x	x	x	x	x
HTOA	Hex to ASCII	x	x	x	x	x	x
ATOH	ASCII to Hex	x	x	x	x	x	x
BTOA	BCD to ASCII	x	x	x	x	x	x
ATOB	ASCII to BCD	x	x	x	x	x	x
ENCO	Encode	x	—	x	*	*	*
DECO	Decode	x	—	x	*	*	*
BCNT	Bit Count	x	—	x	*	*	*
ALT	Alternate Output	x	—	x	*	*	*
CVDT	Convert Data Type	x	—	*	*	*	*
DTDV	Data Divide	x	—	*	*	*	*
DTCB	Data Combine	x	—	*	*	*	*
SWAP	Data Swap	x	—	*	*	*	*
WKTIM	Week Timer	x	x	x	x	x	x
WKTBL	Week Table	x	x	x	x	x	x
DISP	Display	x	x	x	—	—	x
DGRD	Digital Read	x	x	x	—	—	x
TXD1	Transmit 1	—	x	x	x	x	x
TXD2	Transmit 2	x	x	x	*	x	x
TXD3	Transmit 3	x	—	*	—	*	*
TXD4	Transmit 4	x	—	*	—	*	*
TXD5	Transmit 5	x	—	*	—	*	*
TXD6	Transmit 6	x	—	*	—	—	—
TXD7	Transmit 7	x	—	*	—	—	—
ETXD	Transmit Over Ethernet	x	—	—	—	—	—

x: Available

*: Available on the FC5A only

∇: Available on the FC5A-D32K3 and FC5A-D32S3 only

•Advanced Instructions (continued)

Symbol	Function	Slim Type					
		FC5A -D12K1E, D12S1E	—	FC5A -D16RK1, -D16RS1, -D32K3, -D32S3	FC5A -C10R2, C10R2C	FC5A -C16R2, C16R2C	FC5A -C24R2, C24R2C
		—	FC4A -D20K3, -D20S3	FC4A -D20RK1, -D20RS1, -D40K3, -D40S3	FC4A -C10R2, -C10R2C	FC4A -C16R2, -C16R2C	FC4A -C24R2, -C24R2C
RXD1	Receive 1	—	x	x	x	x	x
RXD2	Receive 2	x	x	x	*	x	x
RXD3	Receive 3	x	—	*	—	—	*
RXD4	Receive 4	x	—	*	—	—	*
RXD5	Receive 5	x	—	*	—	—	*
RXD6	Receive 6	x	—	*	—	—	—
RXD7	Receive 7	x	—	*	—	—	—
ERXD	Receive Over Ethernet	x	—	—	—	—	—
LABEL	Label	x	x	x	x	x	x
LJMP	Label Jump	x	x	x	x	x	x
LCAL	Label Call	x	x	x	x	x	x
LRET	Label Return	x	x	x	x	x	x
DJNZ	Decrement Jump Non-zero	x	—	*	*	*	*
DI	Disable Interrupt	x	—	x	*	*	*
EI	Enable Interrupt	x	—	x	*	*	*
IOREF	I/O Refresh	x	x	x	x	x	x
HSCRF	High-speed Counter Refresh	x	—	*	*	*	*
FRQRF	Frequency Measurement Refresh	x	—	*	*	*	*
COMRF	Communication Refresh	x	—	*	—	—	*
XYFS	XY Format Set	x	x	x	*	*	x
CVXTY	Convert X to Y	x	x	x	*	*	x
CVYTX	Convert Y to X	x	x	x	*	*	x
AVRG	Average	x	—	*	*	*	*
PULS1	Pulse Output 1	x	x	x	—	—	—
PULS2	Pulse Output 2	x	x	x	—	—	—
PULS3	Pulse Output 3	x	—	√	—	—	—
PWM1	Pulse Width Modulation 1	x	x	x	—	—	—
PWM2	Pulse Width Modulation 2	x	x	x	—	—	—
PWM3	Pulse Width Modulation 3	x	—	√	—	—	—
RAMP1	Ramp Pulse Output 1	x	x	x	—	—	—
RAMP2	Ramp Pulse Output 2	x	—	√	—	—	—
ZRN1	Zero Return 1	x	—	x	—	—	—
ZRN2	Zero Return 2	x	—	x	—	—	—
ZRN3	Zero Return 3	x	—	√	—	—	—
PID	PID Control	x	x	x	—	—	x
DTML	1-sec Dual Timer	x	—	x	*	*	*
DTIM	100-ms Dual Timer	x	—	x	*	*	*
DTMH	10-ms Dual Timer	x	—	x	*	*	*
DTMS	1-ms Dual Timer	x	—	x	*	*	*
TTIM	Teaching Timer	x	—	x	*	*	*
RUNA	Run Access	x	x	x	—	—	x
STPA	Stop Access	x	x	x	—	—	x
RAD	Degree to Radian	x	—	*	*	*	*
DEG	Radian to Degree	x	—	*	*	*	*
SIN	Sine	x	—	*	*	*	*
COS	Cosine	x	—	*	*	*	*
TAN	Tangent	x	—	*	*	*	*
ASIN	Arc Sine	x	—	*	*	*	*
ACOS	Arc Cosine	x	—	*	*	*	*
ATAN	Arc Tangent	x	—	*	*	*	*
LOGE	Natural Logarithm	x	—	*	*	*	*
LOG10	Common Logarithm	x	—	*	*	*	*
EXP	Exponent	x	—	*	*	*	*
POW	Power	x	—	*	*	*	*
FIFO	FIFO Format	x	—	*	*	*	*
FIEX	First-In Execute	x	—	*	*	*	*
FOEX	First-Out Execute	x	—	*	*	*	*
NDSRC	N Data Search	x	—	*	*	*	*
TADD	Time Addition	x	—	*	*	*	*
TSUB	Time Subtraction	x	—	*	*	*	*
HTOS	HMS to Sec	x	—	*	*	*	*
STOH	Sec to HMS	x	—	*	*	*	*
HOUR	Hour Meter	x	—	*	*	*	*
PING	Ping	x	—	—	—	—	—
EMAIL	Send Email	x	—	—	—	—	—

x: Available

*: Available on the FC5A only

√: Available on the FC5A-D32K3 and FC5A-D32S3 only

Dimensions

All dimensions in mm.

- FC5A-D16RK1, FC4A-D20RK1
- FC5A-D16RS1, FC4A-D20RS1

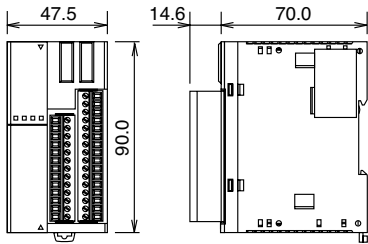

- FC5A-D32K3, FC5A-D32S3
- FC4A-D40K3, FC4A-D40S3

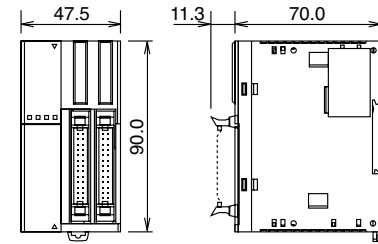

- FC5A-D12K1E, FC5A-D12S1E

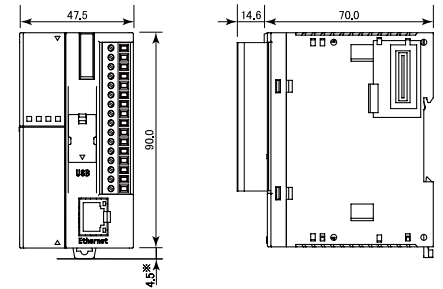

- FC5A-C10R2, FC5A-C16R2
- FC5A-C10R2C, FC5A-C16R2C
- FC5A-C10R2D, FC5A-C16R2D
- FC4A-C10R2, FC4A-C16R2
- FC4A-C10R2C, FC4A-C16R2C

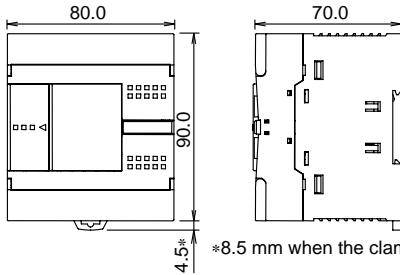

- FC5A-C24R2, FC5A-C24R2C, FC5A-C24R2D
- FC4A-C24R2, FC4A-C24R2C

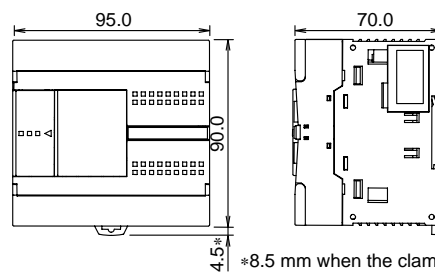

- FC4A-D20K3, FC4A-D20S3

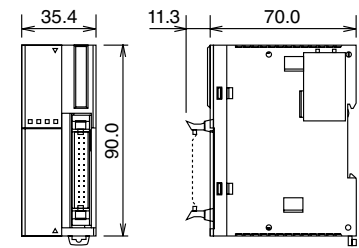

*8.5 mm when the clamp is pulled out.

- FC5A-SIF2, FC5A-SIF4
- FC4A-AS62M, FC4A-N08A11
- FC4A-J2A1, FC4A-N08B1
- FC4A-K1A1, FC4A-R081
- FC4A-K2C1, FC4A-T08K1
- FC4A-L03A1, FC4A-T08S1
- FC4A-L03AP1, FC4A-K4A1
- FC4A-M08BR1

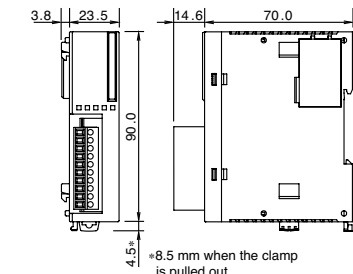

- FC4A-N16B3, FC4A-T16K3, FC4A-T16S3

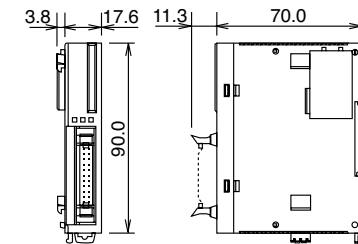

- FC4A-N16B1, FC4A-R161
- FC4A-J4CN1, FC4A-J8C1
- FC4A-J8AT1

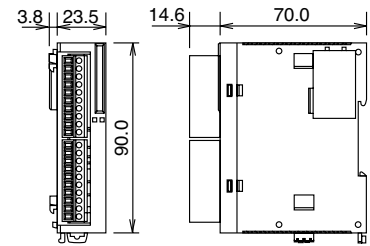

- FC4A-N32B3, FC4A-T32K3, FC4A-T32S3

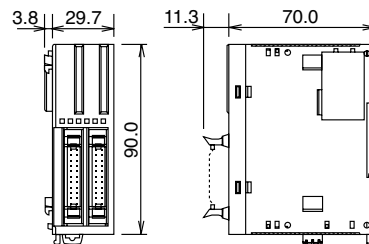

- FC4A-HPC1, FC4A-HPC2, FC4A-HPC3

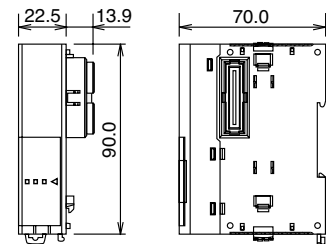

*8.5 mm when the clamp is pulled out.

- FC5A-F2MR2, FC5A-F2M2
- FC4A-M24BR2

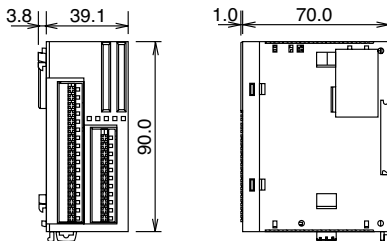

- FC4A-HPH1

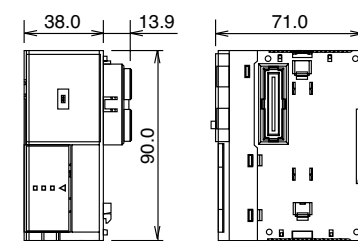

- FC4A-SX5ES1E

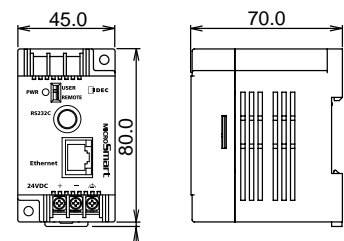

*5.6 mm when the clamp is pulled out.

- FC5A-EXM2

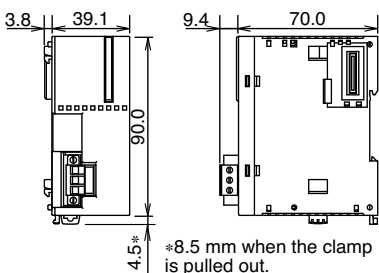

- FC5A-EXM1M

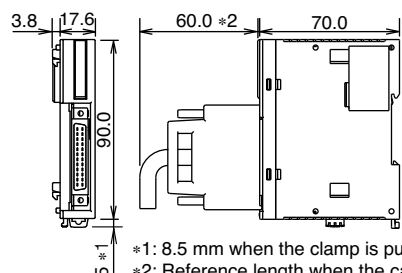

*8.5 mm when the clamp is pulled out.

*1: 8.5 mm when the clamp is pulled out.
*2: Reference length when the cable is bent.

- FC5A-EXM1S

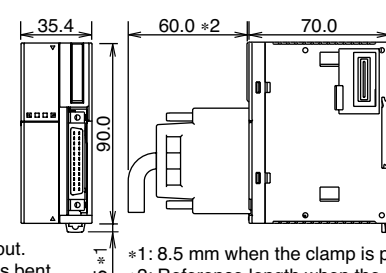

*1: 8.5 mm when the clamp is pulled out.
*2: Reference length when the cable is bent.

Example

The following figure illustrates a system setup consisting of the all-in-one 24-I/O type CPU module, an 8-point relay output module, and a 16-point DC input module mounted on a 35-mm-wide-DIN rail using BNL6 end clips.

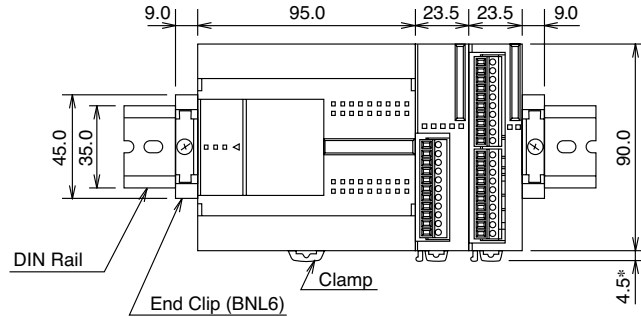

*8.5 mm when the clamp is pulled out.

Mounting Hole Layout

- FC5A-C10R2
- FC5A-C10R2C
- FC5A-C10R2D
- FC5A-C16R2
- FC5A-C16R2C
- FC5A-C16R2D
- FC4A-C10R2
- FC4A-C10R2C
- FC4A-C16R2
- FC4A-C16R2C

- FC5A-C24R2
- FC5A-C24R2C
- FC5A-C24R2D
- FC4A-C24R2
- FC4A-C24R2C

- FC5A-D12K1E
- FC5A-D12S1E
- FC5A-D16RK1
- FC5A-D16RS1
- FC5A-D32K3
- FC5A-D32S3
- FC4A-D20RK1
- FC4A-D20RS1
- FC4A-D40K3
- FC4A-D40S3

- FC5A-SIF2,
- FC4A-AS62M
- FC4A-J2A1
- FC4A-J4CN1
- FC4A-J8AT1
- FC4A-J8C1
- FC4A-K1A1
- FC4A-K2C1
- FC4A-L03A1
- FC4A-L03AP1
- FC4A-M08BR1

- FC5A-SIF4
- FC4A-N08A11
- FC4A-N08B1
- FC4A-N16B1
- FC4A-R081
- FC4A-R161
- FC4A-T08K1
- FC4A-T08S1
- FC4A-K4A1

- FC4A-SX5ES1E

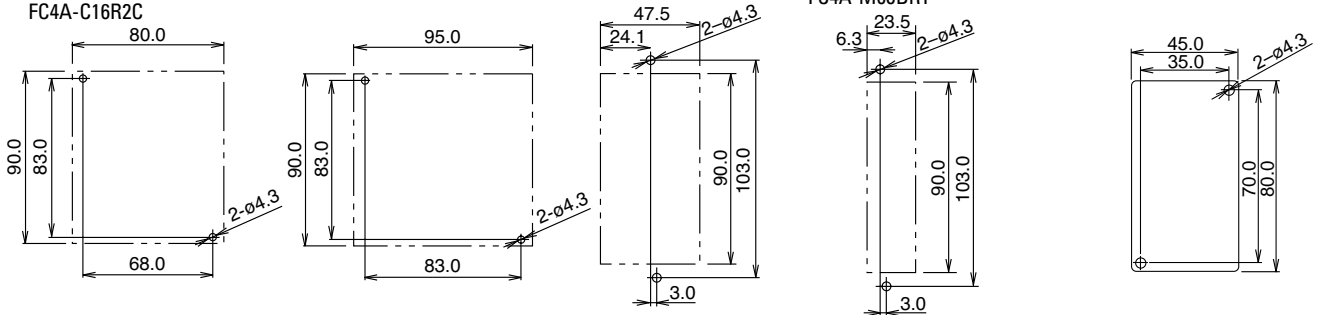

- FC4A-N32B3
- FC4A-T32K3
- FC4A-T32S3

- FC5A-F2MR2
- FC5A-F2M2
- FC5A-EXM2
- FC4A-M24BR2

- FC5A-EXM1S
- FC4A-D20K3
- FC4A-D20S3

- FC5A-EXM1M
- FC4A-N16B3
- FC4A-T16K3
- FC4A-T16S3

- FC4A-HPC1
- FC4A-HPC2
- FC4A-HPC3

- FC4A-HPH1

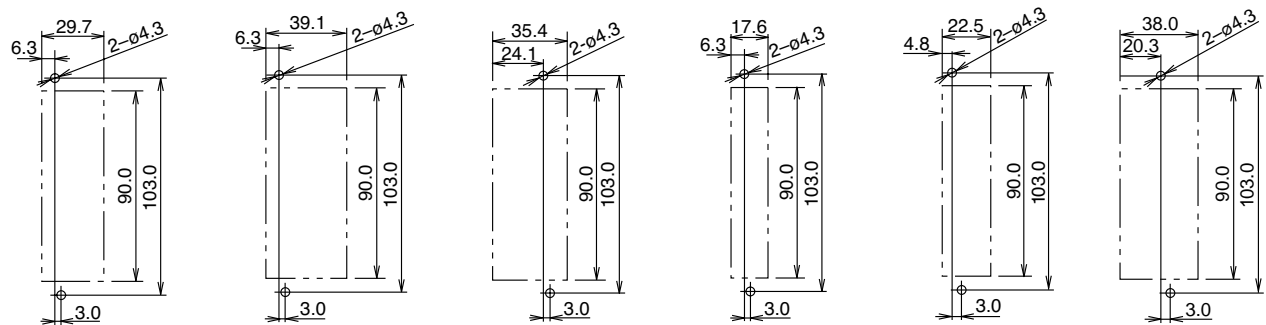

Example

Mounting hole layout for FC5A-C24R2 or FC4A-C24R2 and four 23.5mm-wide I/O modules

Mounting hole layout from left, FC4A-HPH1, FC4A-D20K3, FC4A-N16B3, FC4A-N32B3, and FC4A-M24R2 modules

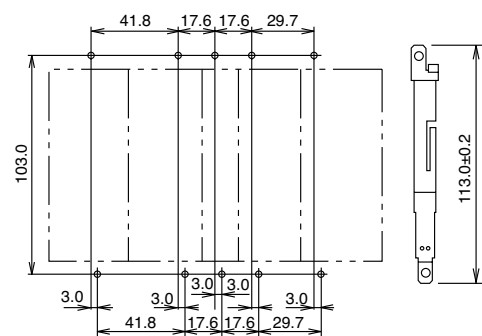
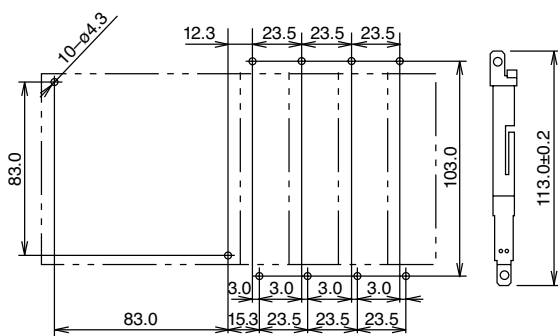

All dimensions in mm.

8.4" and 10.4" HG3G Operator Interfaces

- Super-bright LED backlight
- 600cd/m² (8.4-inch), 700 cd/m² (10.4-inch)
- High-resolution SVGA and 65,536 colors
- More than 7,000 thousand graphic images
- MicroSmart I/O modules are available

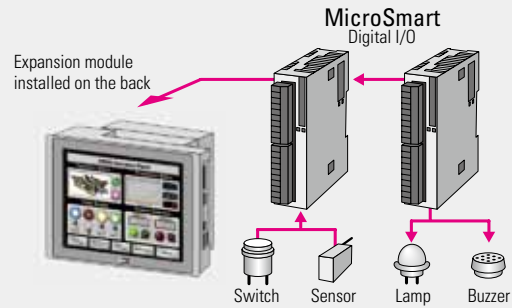

Display Screen	Operation Type	Interface	Housing/ Bezel Color	Part Number
8.4-inch TFT color LCD, 65,536 colors	Touch Switch (analog resistive)	COM1 [RS232C/485 (422)]	Light gray	HG3G-8JT22TF-W
		COM2 [RS232C/485 (422)]	Dark gray	HG3G-8JT22TF-B
LAN [10 Base-T/100 Base-TX]		Light gray	HG3G-AJT22TF-W	
AUDIO OUT [LINE OUT]		Dark gray	HG3G-AJT22TF-B	
10.4-inch TFT color LCD, 65,536 colors		USB1 [USB2.0 Device]		
		USB2 [USB2.0 Host]		
		SD [SD Memory Card]		

Switching Power Supplies - PS3X

- Universal AC input voltage
- Three output types (5V DC, 12V DC and 24V DC) on each five output types variation (15W, 25W, 50W, 75W and 100W)
- EMC EN55022 Class B compliant



Output Capacity	Part No.	Input Voltage	Output Voltage	Output Current
15W	PS3X-B05AFC	100 to 240V AC	5V	3.0A
	PS3X-B12AFC		12V	1.3A
	PS3X-B24AFC		24V	0.63A
25W	PS3X-C05AFC	100 to 240V AC	5V	5.0A
	PS3X-C12AFC		12V	2.1A
	PS3X-C24AFC		24V	1.1A
50W	PS3X-D12AFG	100 to 240V AC	12V	4.2A
	PS3X-D24AFG		24V	2.2A
75W	PS3X-Q05AFG	100 to 240V AC	5V	12.0A
	PS3X-Q12AFG		12V	6.0A
	PS3X-Q24AFG		24V	3.2A
100W	PS3X-E05AFG	100 to 240V AC	5V	16.0A
	PS3X-E12AFG		12V	8.5A
	PS3X-E24AFG		24V	4.5A

I/O Terminals

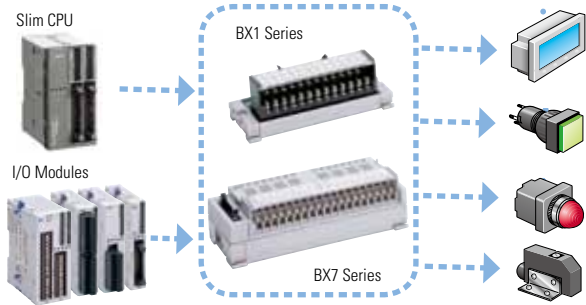

Programmable Controller Type No.	Cable Type No.	I/O Terminal Type No.	Connector
CPU	FC5A-D32K3	FC9Z-H***A26 FC9Z-H***B26	BX1D-*26A BX1F-*26A 26-position MIL connector
	FC5A-D32S3		
	FC4A-D20K3		
	FC4A-D20S3		
	FC4A-D40K3 FC4A-D40S3		
Input	FC4A-N16B3 FC4A-N32B3	FC9Z-H***A20 FC9Z-H***B20	BX1D-*20A BX1F-*20A BX7D-B116AT (16-pt relay output) 20-position MIL connector
	FC4A-T16K3 FC4A-T16S3 FC4A-T32K3 FC4A-T32S3		

Notes

1. Specify a cable length code in place of *** in the Cable Type No. 050: 0.5m, 100: 1m, 200: 2m, 300: 3m
2. A in the Cable Type No. represents shielded cable, B represents non-shielded cable.
3. Specify T or S in place of * in the I/O Terminal Type No.
T: Touch-down terminal, S: Screw terminal

Specifications and other descriptions in this catalog are subject to change without notice.

IDEC CORPORATION

7-31, Nishi-Miyahara 1-Chome, Yodogawa-ku, Osaka 532-8550, Japan
Tel: +81-6-6398-2571, Fax: +81-6-6392-9731
E-mail: marketing@idec.co.jp

IDEC CORPORATION (USA)

1175 Elko Drive, Sunnyvale, CA 94089-2209, USA
Tel: +1-408-747-0550 / (800) 262-IDEC (4332)
Fax: +1-408-744-9055 / (800) 635-6246
Email: opencontact@idec.com

IDEC CANADA LIMITED

3155 Pepper Mill Court, Unit 4, Mississauga, Ontario, L5L 4X7, Canada
Tel: +1-905-890-8561, Toll Free: (888) 317-4332
Fax: +1-905-890-8562
Email: sales@ca.idec.com

IDEC AUSTRALIA PTY. LTD.

Unit 17, 104 Ferntree Gully Road, Oakleigh, Victoria 3166, Australia
Tel: +61-3-8523-5900, Toll Free: 1800-68-4332
Fax: +61-3-8523-5999
Email: sales@au.idec.com

IDEC ELECTRONICS LIMITED

Unit 2, Beechwood, Chineham Business Park, Basingstoke, Hampshire RG24 8WA, UK
Tel: +44-1256-321000, Fax: +44-1256-327755
Email: sales@uk.idec.com

IDEC ELEKTROTECHNIK GmbH

Wendenstrasse 331, 20537 Hamburg, Germany
Tel: +49-40-25 30 54 - 0, Fax: +49-40-25 30 54 - 24
Email: service@idec.de

IDEC (SHANGHAI) CORPORATION

Room 608-609, 6F, Gangtai Plaza, No. 700, Yan'an East Road, Shanghai 200001, PRC
Tel: +86-21-5353-1000, Fax: +86-21-5353-1263
Email: idec@cn.idec.com

IDEC (BEIJING) CORPORATION

Room 211B, Tower B, The Grand Pacific Building, 8A Guanghua Road, Chaoyang District, Beijing 100026, PRC
Tel: +86-10-6581-6131, Fax: +86-10-6581-5119

IDEC (SHENZHEN) CORPORATION

Unit AB-3B2, Tian Xiang Building, Tian'an Cyber Park, Fu Tian District, Shenzhen, Guang Dong 518040, PRC
Tel: +86-755-8356-2977, Fax: +86-755-8356-2944

IDEC IZUMI (H.K.) CO., LTD.

Units 11-15, Level 27, Tower 1, Millennium City 1, 388 Kwun Tong Road, Kwun Tong, Kowloon, Hong Kong
Tel: +852-2803-8989, Fax: +852-2565-0171
Email: info@hk.idec.com

IDEC TAIWAN CORPORATION

8F-1, No. 79, Hsin Tai Wu Road, Sec. 1, Hsi-Chih District, New Taipei City, Taiwan
Tel: +886-2-2698-3929, Fax: +886-2-2698-3931
Email: service@tw.idec.com

IDEC IZUMI ASIA PTE. LTD.

No. 31, Tannery Lane #05-01, HB Centre 2, Singapore 347788
Tel: +65-6746-1155, Fax: +65-6844-5995
Email: info@sg.idec.com

X-ON Electronics

Largest Supplier of Electrical and Electronic Components

Click to view similar products for [Idec manufacturer](#):

Other Similar products are found below :

[LT7A-XE-G](#) [LT7A-XE-R](#) [LT7B-A250](#) [LT7B-A250FB](#) [LW6L-M1C24MG](#) [FB1T-000Z](#) [FB1W-HW1B-V411R-EMO-2](#) [FB1W-XW1E-BV411MR](#) [FB1W-XW1E-BV413MR](#) [FB3W-413Z](#) [FC2A-KP1C](#) [FC4A-J8AT1](#) [FC4A-T16S3](#) [FC5A-C16R2C](#) [MM-SMART-24](#) [MM-SMART-40](#) [FT1A-C12RA-S](#) [FT1A-C12RA-W](#) [FT1A-C14SA-B](#) [PF3S-BP12](#) [PS3X-D24AFG](#) [PS3X-Q12AFG](#) [GT3A-3AD24](#) [GT3F-2EAD24](#) [GT3S-2AF20](#) [GT3W-A16AD24](#) [GT3W-A33AF20N](#) [ABD302N-R](#) [ABD410N-R](#) [ABFD411N-G](#) [ABN4F11-G](#) [HE2B-M211PB](#) [HE2G-21SH](#) [HE9Z-D3B](#) [HG9Z-2A1](#) [HG9Z-XC300](#) [ACSNO-6123-FB-C6002](#) [RH3V2-UAC240V](#) [DFAN-031-B](#) [AL6M-LK1-G](#) [AL6M-P3-R](#) [AL6Q-M13-W](#) [AL6Q-M23P-QG](#) [ALFD29901DN-G-24V](#) [ALFN22211DNG-U](#) [ALFW224611D-W](#) [ALNE8811-G](#) [ALQW2B24611D-G](#) [ALW212611-G](#) [ALW22211DG](#)