

**Power, Performance, Connectivity
MicroSmart FC6A**



16x

Fast Execution

MicroSmart FC6A execution time is comparable to those of PAC controller. It's 16 time faster than FC5A MicroSmart Pentra.

6x

Fast I/O Refresh

Expansion I/O refresh is 6 time faster than FC5A MicroSmart Pentra resulting in more efficient and faster machines.

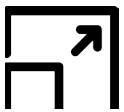

Expanded Memory

Program memory is 640 kB (80,000 steps) with 1,024 timers and 512 counters, six high-speed at rates up to 100kHz. Double the capacity of a typical micro PLC, allows handling of large programs with complex control requirements such as PID, flow totalization and recipes.



Up to 520 Discrete and Analog I/O

Maximum of 126 analog I/O, much more than a typical micro PLC, and approaching PAC capacity



High Speed Outputs

Allows implementation of PAC-like features including:
 ARAMP — Ramp pulse output with table
 JOG — Jog control
 ABS — Initialize Absolute Counter



Upgradable Firmware

Get the latest features without changing CPU or expansion module hardware



Time-Base Applications

Use built-in real time clock or obtain time from SNTP server

IO Touchscreens

PLCs

Automation Software

Power Supplies

Sensors

Communication

Barriers

MicroSmart FC6A PLC CPU Module Specifications

Key Features

- Embedded Ethernet port
- Embedded SD memory port
- Modbus TCP and RTU
- Embedded RS232C/RS485 user selectable
- Maximum 520 digital I/O
- Maximum 126 analog I/O
- Data Logging
- Web Server Functions
- Large programming and data memory
- CAN J1939 CPU
- Built-in Web Page Editor for user webpage



Standard Base Module

Part Number	Total I/O	Power Voltage	Input Voltage	Output Type	Maximum Digital I/O	Maximum Analog I/O
FC6A-C16R1AE	16 (9 inputs, 7 outputs)	100-240V AC	24V DC Sink/Source	Relay	400	100
FC6A-C16R1CE		24V DC		Relay		
FC6A-C16P1CE				Transistor Source		
FC6A-C16K1CE				Transistor Sink		
FC6A-C24R1AE	24 (14 inputs, 10 outputs)	100-240V AC		Relay	504	124
FC6A-C24R1CE		24V DC		Relay		
FC6A-C24P1CE				Transistor Source		
FC6A-C24K1CE				Transistor Sink		
FC6A-C40R1AE	40 (24 inputs, 16 outputs)	100-240V AC		Relay	520	126
FC6A-C40R1CE		24V DC		Relay		
FC6A-C40P1CE				Transistor Source		
FC6A-C40K1CE				Transistor Sink		
FC6A-C40R1DE	12V DC	12V DC Sink/Source	Relay	40	6	
FC6A-C40P1DE			Transistor Source			
FC6A-C40K1DE			Transistor Sink			

CAN J1939 Base Module

Part Number	Total I/O	Power Voltage	Input Voltage	Output Type	Maximum Digital I/O	Maximum Analog I/O
FC6A-C40R1AEJ	40 (24 inputs, 16 outputs)	100-240V AC	24V DC Sink/Source	Relay	520	126
FC6A-C40R1CEJ		24V DC		Relay		
FC6A-C40P1CEJ				Transistor Source		
FC6A-C40K1CEJ				Transistor Sink		
FC6A-C40R1DEJ	12V DC	12V DC Sink/Source	Relay	40	6	
FC6A-C40P1DEJ			Transistor Source			
FC6A-C40K1DEJ			Transistor Sink			

OI Touchscreens

PLCs

Automation Software

Power Supplies

Sensors

Communication

Barriers

Specifications

Part Number	FC6A-C16R1AE FC6A-C16R1CE FC6A-C16P1CE FC6A-C16K1CE	FC6A-C24R1AE FC6A-C24R1CE FC6A-C24P1CE FC6A-C24K1CE	FC6A-C40R1AE FC6A-C40R1CE FC6A-C40P1CE FC6A-C40K1CE FC6A-C40R1DE FC6A-C40P1DE FC6A-C40K1DE	FC6A-C40R1AEJ FC6A-C40R1CEJ FC6A-C40P1CEJ FC6A-C40K1CEJ FC6A-C40R1DEJ FC6A-C40P1DEJ FC6A-C40K1DEJ
Rated Power Voltage	AC: 100 to 240V AC, DC: 24V DC, 12V DC			
Allowable Voltage Range	AC: 85 to 264V AC 24V DC: 20.4 to 28.8V DC (including ripple), 12V DC: 10.2 to 18.0V			
Rated Frequency	AC: 50/60Hz (47 to 63 Hz)			
Maximum Power Consumption (CPU module)	AC	FC6A-C16R1AE: 100-240V AC, 33VA FC6A-C24R1AE: 100-240V AC, 35VA FC6A-C40R1AE: 100-240V AC, 41VA FC6A-C40R1AEJ: 100-240V AC, 37VA		
	DC	FC6A-C16R1CE: 24V DC 140mA, 3.36W FC6A-C24R1CE: 24V DC 155mA, 3.72W FC6A-C40R1CE: 24V DC 195mA, 4.68W FC6A-C16P1CE: 24V DC 190mA, 4.6W	FC6A-C24P1CE: 24V DC 200mA, 4.8W FC6A-C40P1CE: 24V DC 205mA, 5.0W FC6A-C40P1CEJ: 24V DC 175mA, 4.2W FC6A-C40K1CEJ: 24V DC 175mA, 4.2W	FC6A-C40R1DEJ: 12V DC 340mA, 4.08W FC6A-C40P1DEJ: 12V DC 320mA, 3.9W FC6A-C40K1DEJ: 12V DC 320mA, 3.9W
Allowable Momentary Power Interruption	10 ms (at rated voltage)			
Dielectric Strength	Between power and ground terminals: 1,500V AC, 1 minute Between I/O and ground terminals: 1,500V AC, 1 minute			
Insulation Resistance	Between power and ground terminals: 100 MΩ minimum (500V DC megger) Between I/O and ground terminals: 100 MΩ minimum (500V DC megger)			
Noise Resistance	AC or DC power terminal: 1.5kV (DC type: 1kV), 50 ns to 1 μs I/O terminals (coupling clamp): 1.5kV, 50ns to 1 μs coupling adapter			
Inrush Current	AC: 40A maximum 24V DC: 35A maximum 12V DC: 35A maximum			
Power Supply Wire	AWG22, AWG18			
Operating Temperature	-10 to +55°C (no freezing)			
Storage Temperature	-25 to +70°C (no freezing)			
Relative Humidity	Level RH1 (IEC 61131-2-10 to 95% (no condensation)			
Altitude	Operation: 0 to 2,000m, 795 to 1,013hPa, Transport: 0 to 3,000m, 701 to 1,013hPa			
Pollution Degree	2 (IEC 60664-1)			
Corrosion Immunity	Free from corrosive gases			
Degree of Protection	IP20 (IEC 60529)			
Ground	D-type ground (Class 3 ground)			
Grounding Wire	AWG16			
Vibration Resistance	5 to 8.4 Hz amplitude 3.5 mm, 8.4 to 150 Hz acceleration 9.8 m/s ² (1G), 2 hours per axis on each of three mutually perpendicular axes (IEC 61131-2)			
Shock Resistance	147 m/s ² (15G), 11 ms duration, 3 shocks per axis on three mutually perpendicular axes			
Mounting	DIN rail or panel mounting			
Weight	AC: 350g DC: 340g	AC: 420g DC: 400g	AC: 560g DC (relay): 530g DC (transistor): 480g	AC: 560g DC (relay/24V DC): 530g DC (relay/12V DC): 560g DC (transistor/24V DC): 480g DC (transistor/12V DC): 530g

I/O Touchscreens

PLCs

Automation Software

Power Supplies

Sensors

Communication

Barriers

Specifications Cont.

OI Touchscreens

PLCs

Automation Software

Power Supplies

Sensors

Communication

Barriers

Part Number		FC6A-C16R1AE FC6A-C16R1CE FC6A-C16P1CE FC6A-C16K1CE	FC6A-C24R1AE FC6A-C24R1CE FC6A-C24P1CE FC6A-C24K1CE	FC6A-C40R1AE FC6A-C40P1CE FC6A-C40R1DE FC6A-C40K1DE	FC6A-C40R1CE FC6A-C40K1CE FC6A-C40P1DE	FC6A-C40R1AEJ FC6A-C40P1CEJ FC6A-C40R1DEJ FC6A-C40K1DEJ	FC6A-C40R1CEJ FC6A-C40K1CEJ FC6A-C40P1DEJ
Control System		Stored program system					
Instruction Words	Basic	42					
	Advanced	124					
Program Capacity ¹		384KB (48,000 steps)/72KB (9,000 steps) ²				640KB (80,000) 72KB (9,000 steps) ²	
User Program Storage		Serial Flash Memory (100,000 times rewritable)					
Processing Time	Basic Instruction	42us/1,000 steps					
	END Processing ³	1ms maximum					
I/O Points	Input	9 points	14 points			24 points	
	Output	7 points	10 points			16 points	
Expandable Modules		4 modules			7 modules		
Expandable I/O Points with Expansion Modules		128 points			224 points		
Expandable Modules with Expansion Interface Modules						8 modules	
Expandable I/O Points with Expansion Interface Modules						256 points	
Internal Relay						12,400 points	
Special Internal Relay						256 points	
Shift Register						256 points	
Data Register						54,000 points	
Special Data Register						500 points	
Counter						512 points	
Timer (1ms, 10ms, 100ms, 1s)						1,024 points	
Clock		Clock accuracy: ±30 sec/month (typical) at 25°C					
RAM Backup	Backup Data	Internal relay, shift register, counter, data register, timer, special data register, special internal relay					
	Battery	Lithium primary battery (BR2032)					
	Battery Life	Approx. 4 years					
	Replaceability	Possible					
Self-diagnostic Function		Keep data, user program sum check (EEPROM), user program sum check (RAM), timer/counter preset value sum check, user program syntax check, user program execution check, WDT check, user program write check, power failure, clock error, data link connection check, I/O bus initialization check					
Input Filter		0 ms (without filter), 3 to 15ms (selectable in increments of 1ms)					
Catch Input/Interrupt Input		Six inputs I0, I1, I6, I7 Minimum turn on pulse width: 5µs max. Minimum turn off pulse width: 5µs max.		I3, I4 Minimum turn on pulse width: 35µs max. Minimum turn off pulse width: 35µs max.			
High-speed Counter	Maximum Counting Frequency and High-speed Counter Points	Total 6 points Single/two-phase selectable: 100 kHz (single-phase: 4 points, two-phase: 2 points)					
	Counting Range	Single-phase: 5 kHz (2 points) 0 to 4,294,967,295 (32 bits)					
	Operation Mode	Rotary encoder mode, adding counter mode, frequency measurement mode					
Analog Potentiometer	Quantity	1 point				-	
	Data Range	0 to 1,000				-	
Analog Voltage Input	Quantity	1 point				-	
	Input Voltage Range	0 to 10V				-	
	Input Impedance	Approx. 100KΩ				-	
	Digital Resolution	Approx. 1,000 steps (10 bits)				-	
Pulse Output	Quantity	4 points					
	Maximum Frequency	High speed output port: 100 kHz (2 points) maximum		Middle speed output port: 5 kHz (2 points maximum)		High speed output port: 100 kHz maximum	
External Power Supply for Sensor (AC only)	Output Voltage/Current	24V (+10%, -15%) / 250mA					
	Overload Detection	Impossible					
	Isolation from the internal circuit	Transformer-isolated					
USB Port		USB mini-B (maintenance communication)					
Serial Port 1, CAN Port		RS232C or RS485 ⁴				CAN J1939	
Ethernet Port 1		Ethernet (maintenance communication, user communication, user communication, Modbus TCP server/client)					
SD Card Slot		Embedded					
Cartridge (option)		One cartridge can be added			Two cartridges can be added		
HMI Module (option)		Yes	Yes	Yes	Yes	Yes	

Note: The maximum number of relay outputs that can be turned on simultaneously is limited.

Note 1: 1 step equals 8 bytes.

Note 2: When 72KB is selected, download function can be used during RUN.

Note 3: Not including expansion I/O service time, counter timer processing time, data link processing time, and interrupt processing time.

Note 4: Maintenance communication, user communication, data link, Modbus RTU master/slave communication.

Specifications Cont.

Part Number	FC6A-C16R1AE FC6A-C16R1CE FC6A-C16P1CE FC6A-C16K1CE	FC6A-C24R1AE FC6A-C24R1CE FC6A-C24P1CE FC6A-C24K1CE	FC6A-C40R1AE FC6A-C40P1CE FC6A-C40R1DE FC6A-C40K1DE	FC6A-C40R1CE FC6A-C40K1CE FC6A-C40P1DE	FC6A-C40R1AEJ FC6A-C40R1CEJ FC6A-C40R1DEJ FC6A-C40P1DEJ FC6A-C40K1DEJ
Control System	Stored program system				
Instruction Words	Basic	42			
	Advanced	124			
Program Capacity ¹	384KB (48,000 steps)/72KB (9,000 steps) ²			640KB (80,000) 72KB (9,000 steps) ²	
User Program Storage	Serial Flash Memory (100,000 times rewritable)				
Processing Time	Basic Instruction	42us/1,000 steps			
	END Processing ³	1ms maximum			
I/O Points	Input	9 points	14 points	24 points	
	Output	7 points	10 points	16 points	
Expandable Modules	4 modules		7 modules		
Expandable I/O Points with Expansion Modules	128 points		224 points		
Expandable Modules with Expansion Interface Modules					8 modules
Expandable I/O Points with Expansion Interface Modules					256 points
Internal Relay					12,400 points
Special Internal Relay					256 points
Shift Register					256 points
Data Register					54,000 points
Special Data Register					500 points
Counter					512 points
Timer (1ms, 10ms, 100ms, 1s)					1,024 points
Clock	Clock accuracy: ±30 sec/month (typical) at 25°C				
RAM Backup	Backup Data	Internal relay, shift register, counter, data register, timer, special data register, special internal relay			
	Battery	Lithium primary battery (BR2032)			
	Battery Life	Approx. 4 years			
	Replaceability	Possible			
Self-diagnostic Function	Keep data, user program sum check (EEPROM), user program sum check (RAM), timer/counter preset value sum check, user program syntax check, user program execution check, WDT check, user program write check, power failure, clock error, data link connection check, I/O bus initialization check				
Input Filter	0 ms (without filter), 3 to 15ms (selectable in increments of 1ms)				
Catch Input/Interrupt Input	Six inputs I0, I1, I6, I7 Minimum turn on pulse width: 5µs max. Minimum turn off pulse width: 5µs max.		I3, I4 Minimum turn on pulse width: 35µs max. Minimum turn off pulse width: 35µs max.		
High-speed Counter	Maximum Counting Frequency and High-speed Counter Points	Total 6 points Single/two-phase selectable: 100 kHz (single-phase: 4 points, two-phase: 2 points) Single-phase: 5 kHz (2 points)			
	Counting Range	0 to 4,294,967,295 (32 bits)			
	Operation Mode	Rotary encoder mode, adding counter mode, frequency measurement mode			
Analog Potentiometer	Quantity	1 point			-
	Data Range	0 to 1,000			-
Analog Voltage Input	Quantity	1 point			-
	Input Voltage Range	0 to 10V			-
	Input Impedance	Approx. 100KΩ			-
	Digital Resolution	Approx. 1,000 steps (10 bits)			-
Pulse Output	Quantity	4 points			
	Maximum Frequency	High speed output port: 100 kHz (2 points) maximum		Middle speed output port: 5 kHz (2 points maximum) High speed output port: 100 kHz maximum	
External Power Supply for Sensor (AC only)	Output Voltage/Current	24V (+10%, -15%) / 250mA			
	Overload Detection	Impossible			
	Isolation from the internal circuit	Transformer-isolated			
USB Port	USB mini-B (maintenance communication)				
Serial Port 1, CAN Port	RS232C or RS485 ⁴			CAN J1939	
Ethernet Port 1	Ethernet (maintenance communication, user communication, user communication, Modbus TCP server/client)				
SD Card Slot	Embedded				
Cartridge (option)	One cartridge can be added		Two cartridges can be added		
HMI Module (option)	Yes	Yes	Yes	Yes	

Note: The maximum number of relay outputs that can be turned on simultaneously is limited.

Note 1: 1 step equals 8 bytes.

Note 2: When 72KB is selected, download function can be used during RUN.

Note 3: Not including expansion I/O service time, counter timer processing time, data link processing time, and interrupt processing time.

Note 4: Maintenance communication, user communication, data link, Modbus RTU master/slave communication.

I/O Touchscreens

PLCs

Automation Software

Power Supplies

Sensors

Communication

Barriers

Temperature derating curves: Input voltage vs. I/O Simultaneous ON Ratio (%)

Input (with cartridge)

- FC6A-C16K1CE
- FC6A-C24K1CE
- FC6A-C40K1CE
- FC6A-C40K1DE
- FC6A-C40K1CEJ
- FC6A-C40K1DEJ

Output (with cartridge)

- FC6A-C16K1CE
- FC6A-C24K1CE
- FC6A-C40K1CE
- FC6A-C40K1DE
- FC6A-C40K1CEJ
- FC6A-C40K1DEJ

Input (w/o cartridge)

- FC6A-C24P1CE
- FC6A-C40P1CE
- FC6A-C40P1DE
- FC6A-C40P1CEJ
- FC6A-C40P1DEJ

Output (w/o cartridge)

- FC6A-C24P1CE
- FC6A-C40P1CE
- FC6A-C40P1DE
- FC6A-C40P1CEJ
- FC6A-C40P1DEJ

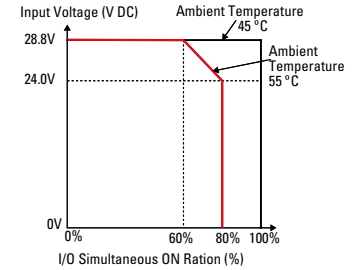
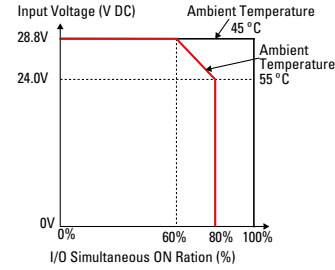
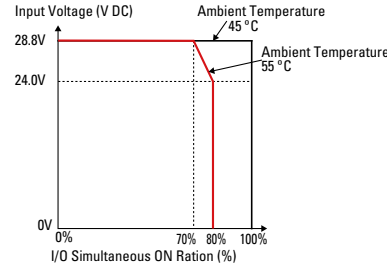
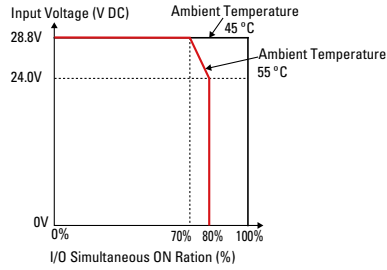

Input (with cartridge)

- FC6A-C24P1CE
- FC6A-C40P1CEJ
- FC6A-C40P1CE
- FC6A-C40P1DEJ
- FC6A-C40P1DE

Output (with cartridge)

- FC6A-C24P1CE
- FC6A-C40P1CEJ
- FC6A-C40P1CE
- FC6A-C40P1DEJ
- FC6A-C40P1DE

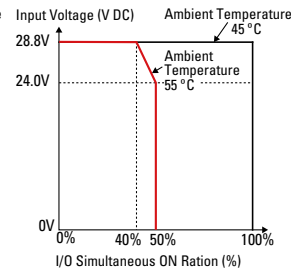
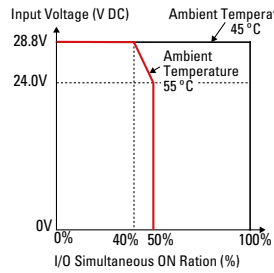

Input Internal Circuit

100V to 240V AC, 24V DC

Transistor Sink Output

I0, I1, I6, I7

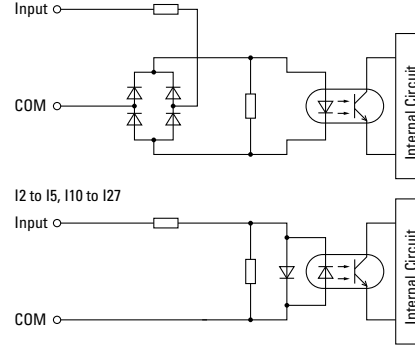

12V DC

Transistor Sink Output

I0, I1, I6, I7

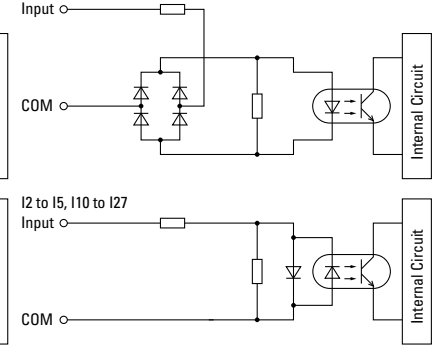

Output Internal Circuit

100V to 240V AC, 24V DC

Transistor Sink Output

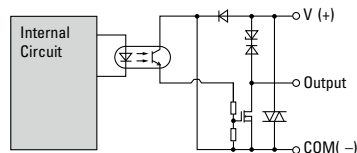

12V DC

Transistor Sink Output

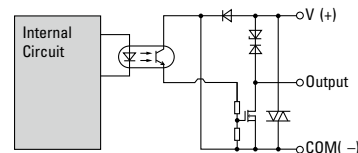

100V to 240V AC, 24V DC

Transistor Source Output

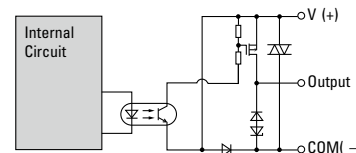

12V DC

Transistor Source Output

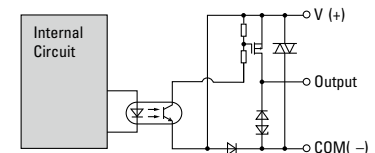

OI Touchscreens

PLCs

Automation Software

Power Supplies

Sensors

Communication

Barriers

MicroSmart FC6A PLC Digital I/O Specifications



Key Features

- 16 modules to choose from
- Screw or MIL type terminal block
- 8/16/32 points I/O module

Specifications

Input Module Specifications

Part Number	FC6A-N08B1	FC6A-N16B1	FC6A-N16B3	FC6A-N32B3	FC6A-N08A11	
Input Points	8 (8/1 common)	16 (16/1 common)		32 (16/1 common)	8 (4/1 common)	
Rated Input Voltage	24V DC sink/source input signal				100 to 120V AC	
Input Voltage Range	0 to 28.8V DC				0 to 132V AC (50/60 Hz)	
Rated Input Current	7 mA/point (24V DC)		5 mA/point (24V DC)		17 mA/point (120V AC, 60 Hz)	
Input Impedance	3.4 kΩ		4.4 kΩ		0.8 kΩ (60 Hz)	
OFF Voltage	5V maximum				20V maximum	
ON Voltage	15V minimum				79V minimum	
OFF Current	1.2 mA maximum		0.9 mA maximum		—	
ON Current	4.2 mA minimum (at 15V DC)		3.2 mA minimum (at 15V DC)		—	
Input Delay Time (24V DC)	Turn ON: 4.1ms, Turn OFF: 4.1ms				Turn ON: 25ms, Turn OFF: 30ms	
Isolation	Between input terminals: Not isolated Internal circuit: Photocoupler-isolated				Between input terminals in the same common: Not isolated Between input terminals in different commons: Isolated Between input terminals and internal circuits: Photocoupler-isolated	
External Load for I/O Interconnection	Not needed					
Signal Determination Method	Static					
Effect of Improper Input Connection	Both sink and source input signals can be connected. If any input exceeding the rated value is applied, permanent damage may be caused.				If any input exceeding the rated value is applied, permanent damage may be caused.	
Cable Length	3m in compliance with electromagnetic immunity				—	
Connector Insertion/Removal Durability	100 times minimum					
Applicable Ferrule	1-wire: AI 0.5-8 WH (Phoenix Contact) 2-wire: AI-TWIN 2×0.5-10 (Phoenix Contact)		—			
Internal Current Draw	All Inputs ON	30mA (5V DC) 0mA (24V DC)	40mA (5V DC) 0mA (24V DC)	40mA (5V DC) 0mA (24V DC)	65mA (5V DC) 0mA (24V DC)	40mA (5V DC) 0mA (24V DC)
	All Inputs OFF	17mA (5V DC) 0mA (24V DC)	17mA (5V DC) 0mA (24V DC)	17mA (5V DC) 0mA (24V DC)	17mA (5V DC) 0mA (24V DC)	17mA (5V DC) 0mA (24V DC)
Internal Power Consumption (at 24V DC while all inputs ON)	0.20W	0.27W	0.27W	0.44W	0.27W	
Weight (approx.)	110g	105g	75g	110g	110g	

01 Touchscreens

PLCs

Automation Software

Power Supplies

Sensors

Communication

Barriers

Relay Output Module Specifications

Part Number	FC6A-R081	FC6A-R161
Output Points	8 (4/1 common)	16 (8/1 common)
Output Type	1NO	
Maximum Load Current	2A per point	
	7A per common	8A per common
Minimum Switching Load	1 mA/ 5V DC (reference value)	
Initial Contact Resistance	30 mΩ maximum	
Electrical Life	100,000 operations minimum (rated load 1,800 operations/hour)	
Mechanical Life	20,000,000 operations minimum (no load 18,000 operations/hour)	
Rated Load	Resistive load: 240V AC 2A, 30V DC 2A Inductive load: 240V AC 2A (cos φ = 0.4) 30V DC 2A (L/R = 7 ms)	
Dielectric Strength	Between output and ground terminals: 1,500V AC, 1 minute Between output terminal and internal circuit: 1,500V AC, 1 minute Between output terminals (COMs): 1,500V AC, 1 minute	
Connector Insertion/Removal Durability	100 times minimum	
Applicable Ferrule	1-wire: AI 0.5-10 (Phoenix Contact) 2-wire: AI-TWIN 2x0.5-10 (Phoenix Contact)	
Internal Current Draw	All outputs ON	35mA (5V DC) 50mA (24V DC)
	All outputs OFF	17mA (5V DC) 0mA (24V DC)
Internal Power Consumption (at 24V DC while all outputs ON)	1.44W	2.74W
Weight (approx.)	130g	140g

Transistor Output Module Specifications

Part Number	FC6A-T08K1 FC6A-T08P1	FC6A-T16K1 FC6A-T16P1	FC6A-T16K3 FC6A-T16P3	FC6A-T32K3 FC6A-T32P3
Output Points	8 (8/1 common)	16 (16/1 common)		32 (16/1 common)
Output Type	FC6A-T□□□: Transistor sink output FC6A-T□□□: Transistor source output			
Rated Load Voltage	24V DC			
Operating Load Voltage Range	19.2 to 28.8V DC			
Maximum Load Current	0.5A per point		0.1A per point	
	3A per common		1A per common	
Voltage Drop (ON Voltage)	1V maximum (voltage between COM and output terminals when output is on)			
Inrush Current	1A maximum			
Leakage Current	0.1mA maximum			
Clamping Voltage	Approx. 50V			
Maximum Lamp Load	12W		2.4W	
Inductive Load	L/R = 10ms (28.8V DC 1Hz)			
External Current Draw	FC6A-T□□□: 100 mA maximum, 24V DC (power voltage at the +V terminal) FC6A-T□□□: 100 mA maximum, 24V DC (power voltage at the -V terminal)			
Overcurrent Protection	Transistor Sink Output: No Transistor Source Output: Yes			
Isolation	Between output terminal and internal circuit: Photocoupler-isolated Between output terminals: Not isolated			
Connector Insertion/Removal Durability	100 times minimum			
Applicable Ferrule	1-wire: AI 0.5-10 (Phoenix Contact) 2-wire: AI-TWIN 2x0.5-10 (Phoenix Contact)			
Internal Current Draw	All outputs ON	25mA (5V DC) 15mA (24V DC)	30mA (5V DC) 25mA (24V DC)	45mA (5V DC) 50mA (24V DC)
	All outputs OFF	17mA (5V DC) 0mA (24V DC)	17mA (5V DC) 0mA (24V DC)	17mA (5V DC) 0mA (24V DC)
Internal Power Consumption (at 24V DC while all outputs ON)	0.53W	0.80W		1.50W
Output Delay	Turn ON Time	400 μs maximum		
	Turn OFF Time	450 μs maximum		
Weight (approx)	110g	105g	75g	115g

Mixed I/O Module Specifications

Part Number		FC6A-M08BR1	FC6A-M24BR1	
Input Specifications	Input Points	4 (4/1 common)	16 (16/1 common)	
	Rated Input Voltage	24V DC sink/source input signal		
	Input Voltage Range	0 to 28.8V DC		
	Rated Input Current	7 mA/point (24V DC)		
	Input Impedance	3.4 kΩ		
	OFF Voltage	5V maximum		
	ON Voltage	15V minimum		
	OFF Current	1.2 mA maximum		
	ON Current	4.2 mA minimum (at 15V DC)		
	Input Delay Time (24V DC)	Turn ON Time: 4.1ms, Turn OFF Time: 4.1ms		
	Isolation	Between input terminals: Not isolated Internal circuit: Photocoupler-isolated		
	External Load for I/O Interconnection	Not needed		
	Signal Determination Method	Static		
	Effect of Improper Input Connection	Both sinking and sourcing input signals can be connected. If any input exceeding the rated value is applied, permanent damage may be caused.		
	Output Specifications	Cable Length	3m in compliance with electromagnetic immunity	
Output Points		4 (4/1 common)	8 (4/1 common)	
Output Type		1NO		
Maximum Load Current		2A per point 7A per common		
Minimum Switching Load		1 mA/ 5V DC (reference value)		
Initial Contact Resistance		30 mΩ maximum		
Electrical Life		100,000 operations minimum (rated load 1,800 operations/hour)		
Mechanical Life		20,000,000 operations minimum (no load 18,000 operations/hour)		
Rated Load		Resistive load: 240V AC 2A, 30V DC 2A Inductive load: 240V AC 2A (cos φ = 0.4), 30V DC 2A (L/R = 7 ms)		
Dielectric Strength		Between output and PE terminals: 1,500V AC, 1 minute Between output terminal and internal circuit: 1,500V AC, 1 minute Between output terminals (COMs): 1,500V AC, 1 minute		
Connector Insertion/Removal Durability		100 times minimum		
Applicable Ferrule		1-wire: AI 0.5-10 (Phoenix Contact), 2-wire: AI-TWIN 2×0.5-10 (Phoenix Contact)		
Internal Current Draw		All I/Os ON	30mA (5V DC), 25mA (24V DC)	55mA (5V DC), 25mA (24V DC)
		All I/Os OFF	17mA (5V DC), 0mA (24V DC)	17mA (5V DC), 0mA (24V DC)
Internal Power Consumption (at 24V DC while all I/Os are ON)		0.80W	0.97W	
Weight (approx.)	120g	165g		

I/O Touchscreens

PLCs

Automation Software

Power Supplies

Sensors

Communication

Barriers

OI Touchscreens

Temperature derating curves: Input voltage vs. I/O Simultaneous ON Ratio (%)

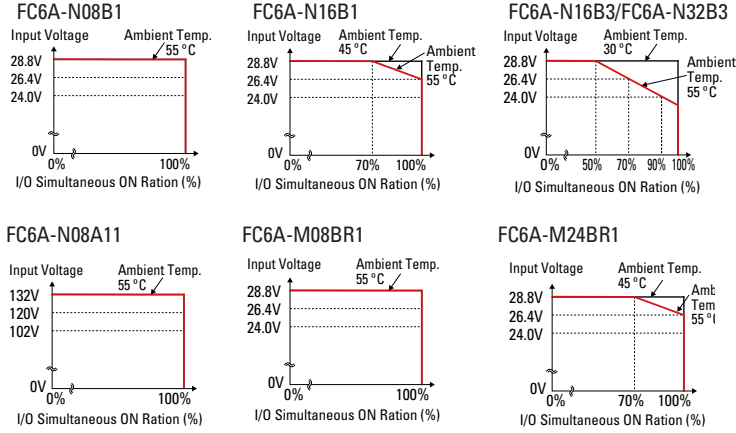

Output Internal Circuit

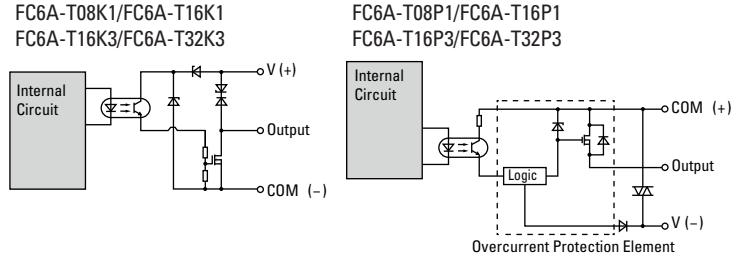

PLCs

Input Internal Circuit

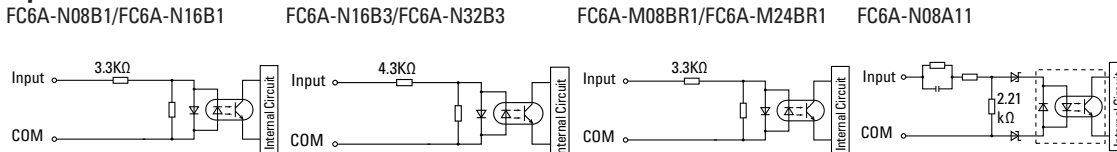

Automation Software

Dimensions (all dimensions are in mm)

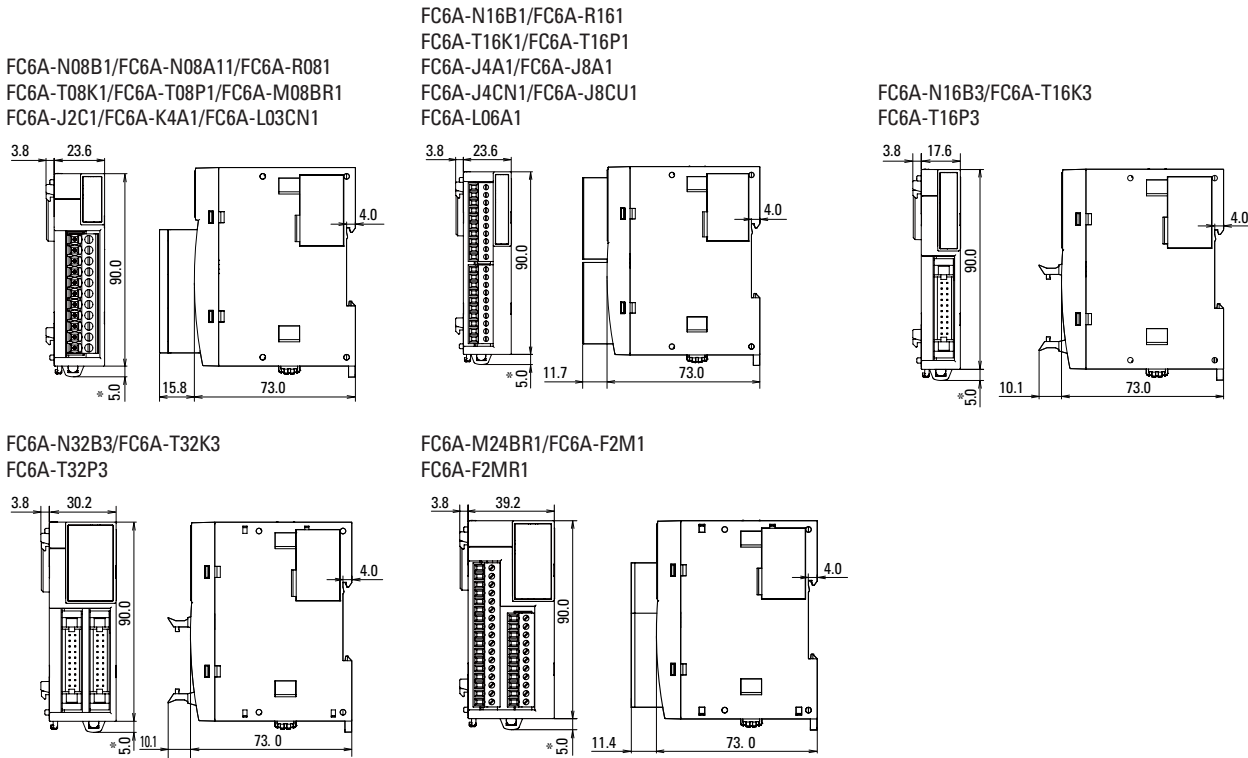

* 9.3 mm when the clamp is pulled out.

Power Supplies

Sensors

Communication

Barriers

MicroSmart FC6A PLC Analog I/O Module Specifications



Key Features

- 8 modules to choose from
- Up to 16-bit resolution
- Fast sampling rate
- Wide range of signals:
- 0/4-20mA, 0-10V DC, -10 to 10V DC, Type K, J, R, S, B, E, T, N, C thermocouple and RTD

Specifications

Analog I/O Module Specifications

Part Number	FC6A-J2C1	FC6A-J4A1	FC6A-J8A1	FC6A-L06A1	FC6A-L03CN1	FC6A-J4CN1	FC6A-J8CU1	FC6A-K4A1
Input Points	2	4	8	4	2	4	8	-
Input Signal Type	Voltage (0 to 10V) Current (0 to 20mA)			Voltage (-10 to +10V) Current (4 to 20mA)	Voltage (0 to 10V) Voltage (-10 to +10V) Current (0 to 20mA) Current (4 to 20mA) Thermocouple Resistance Thermometer	Thermocouple Thermistor (NTC, PTC)		-
Output Points	-	-	-	2	1	-	-	4
Output Signal Style	-	-	-	Voltage (0 to 10V) Voltage (-10 to +10V) Current (0 to 20mA) Current (4 to 20mA)	-	-	-	Voltage (0 to 10V) Voltage (-10 to +10V) Current (0 to 20mA) Current (4 to 20mA)
External Power Supply	Rated Power Voltage 24V DC, Allowable Voltage Range 20.4 to 28.8V DC							
External Current Draw (24V DC) ¹	25mA	30mA	40mA	100mA	80mA	40mA	30mA	125mA
Connector Insertion/ Removal Durability	100 times minimum							
Applicable Ferrule	1-wire: AI 0.5-10 (Phoenix Contact), 2-wire: AI-TWIN 2x0.5-10 (Phoenix Contact)							
Internal Power Consumption (5V DC)	40mA max.	45mA max.	40mA max.	55mA max.	55mA max.	50mA max.	45mA max.	50mA max.
Internal Power Consumption (at 24V DC while all I/Os are ON)	0.27W	0.30W	0.27W	0.37W	0.37W	0.34W	0.30W	0.34W
Weight (approx.)	115g	110g	110g	110g	115g	110g	110g	115g

Note 1: The external current draw is the value when all the analog inputs are used and the analog output value is at 100%.

Analog Input Specifications (1)

Part Number		FC6A-J2C1		FC6A-J4A1/FC6A-J8A1/FC6A-L06A1	
Input Signal Type		Voltage Input	Current Input	Voltage Input	Current Input
Input Range		0 to 10V -10 to +10V	0 to 20mA 4 to 20mA	0 to 10V -10 to +10V	0 to 20mA 4 to 20mA
Input Impedance		1MΩ maximum	50Ω maximum	1MΩ maximum	50Ω maximum
Input Detection Current		-	-	-	-
AD Conversion	Sampling Duration Time	1ms		1ms or 10ms (selectable with application software)	
	Sampling Repetition Time	Sampling time × valid input channels			
	Total Input System Transfer Time	Sampling time + sampling interval + 1 scan time			
Type of Input		Single-ended input			
Operating Mode		Self-scan			
Conversion Method		Σ Δ type ADC			
Input Error	Maximum Error at 25°C	±0.1% of full scale		±0.2% of full scale	
	Cold Junction Compensation Error	-	-	-	-
	Temperature Coefficient	±0.006% of full scale/°C		±0.01% of full scale/°C	
Digital Resolution		65,536 increments (16 bits)		4,096 increments (12 bits)	
Data	Input per Resolution	0 to 10V: 0.15mV -10 to +10V: 0.30mV	0 to 20mA: 0.30μA 4 to 20mA: 0.244μA	0 to 10V: 2.44mV -10 to +10V: 4.88mV	0 to 20mA: 4.88μA 4 to 20mA: 3.91μA
	Data Type in Application Program	Optional: -32,768 to 32,767 (selectable for each channel) ¹			
	Monotonicity	Yes			
Input Data Out of Range		Detectable ²			
Noise Resistance	Input Filter	Soft filter (0 to 10 s, selectable in increments of 0.1 s)			
	Recommended Cable for Noise Immunity	Twisted pair shielded cable			
	Crosstalk	1LSB maximum			
Isolation		Between input and power circuit: Transformer-isolated Between input and internal circuit: Photocoupler-isolated			
Effect of Improper Input Connection		No damage			
Maximum Permanent Allowed Overload (No Damage)		13V DC	40mA	13V DC	40mA
Selection of Analog Input Signal Type		Using programming software			
Calibration or Verification to Maintain Rated Accuracy		Not possible			

Note 1: The data processed in the analog I/O module can be linear-converted to a value between -32,768 and 32,767. The optional range designation, and analog I/O data minimum and maximum values can be selected using data registers allocated to analog I/O modules.

Note 2: When an error is detected, a corresponding error code is stored to a data register allocated to analog I/O operating status.

OI Touchscreens

PLCs

Automation Software

Power Supplies

Sensors

Communication

Barriers

Analog Input Specifications (2)

Part Number	FC6A-L03CN1/FC6A-J4CN1				FC6A-J8CU1			
Input Signal Type	Voltage Input	Current Input	Resistance Thermometer	Thermocouple	Thermocouple	NTC Thermistor	PTC Thermistor	
Input Range	0 to 10V DC -10 to +10V	0 to 20mA 4 to 20mA	Pt100, Pt1000 3-wire type (-200 to 850°C) Ni100, Ni1000 3-wire type (-60 to 180°C)	Type K (-200 to +1,300°C) Type J (-200 to +1,000°C) Type R (0 to 1,760°C) Type S (0 to 1,760°C) Type B (0 to 1,820°C) Type E (-200 to +800°C) Type T (-200 to +400°C) Type N (-200 to +1,300°C) Type C (0 to 2,315°C)	Type K (-200 to +1,300°C) Type J (-200 to +1,000°C) Type R (0 to 1,760°C) Type S (0 to 1,760°C) Type B (0 to 1,820°C) Type E (-200 to +800°C) Type T (-200 to +400°C) Type N (-200 to +1,300°C) Type C (0 to 2,315°C)	-90 to +150°C	100 to 10,000Ω	
Input Impedance	1 MΩ minimum	50Ω maximum	1 MΩ minimum	1 MΩ minimum	1 MΩ minimum	1 MΩ minimum		
Input Detection Current	—	—	0.1mA maximum	0.1mA maximum	0.1mA maximum	0.1mA maximum		
AD Conversion	Sampling Duration Time	10ms, 100ms or 104ms (selectable using application software)				104ms		
	Sampling Repetition Time	Sampling time × valid input channels						
	Total Input System Transfer Time	Sampling time + sampling interval + 1 scan time						
	Type of Input	Single-ended input						
	Operating Mode	Self-scan						
	Conversion Method	Σ Δ type ADC						
Input Error	Maximum Error at 25°C	±0.2% of full scale	FC6A-L03CN1: ±0.1% of full scale + cold junction compensation error FC6A-J4CN1: ±0.2% of full scale + cold junction compensation error ³		±0.2% of full scale + cold junction compensation error ³			
	Cold Junction Compensation Error	—	—	±4°C maximum		±4°C maximum		
	Temperature Coefficient	FC6A-L03CN1: 0.006%/°C of full scale FC6A-J4CN1: 0.01%/°C of full scale			0.01%/°C of full scale			
Data	Digital Resolution	65,536 increments (16 bits)		Pt100: approx. 10,500 increments (14 bits) Pt1,000: approx. 8,000 increments (13 bits) Ni100: approx. 2,400 increments (12 bits) Ni1,000: approx. 2,400 increments (12 bits)	Type K: approx. 15,000 increments (14 bits) Type J: approx. 12,000 increments (14 bits) Type R: approx. 17,600 increments (15 bits) Type S: approx. 17,600 increments (15 bits) Type B: approx. 18,200 increments (15 bits) Type E: approx. 10,000 increments (14 bits) Type T: approx. 6,000 increments (13 bits) Type N: approx. 15,000 increments (14 bits) Type C: approx. 23,150 increments (15 bits)	Type K: approx. 15,000 increments (14 bits) Type J: approx. 12,000 increments (14 bits) Type R: approx. 17,600 increments (15 bits) Type S: approx. 17,600 increments (15 bits) Type B: approx. 18,200 increments (15 bits) Type E: approx. 10,000 increments (14 bits) Type T: approx. 6,000 increments (13 bits) Type N: approx. 15,000 increments (14 bits) Type C: approx. 23,150 increments (15 bits)	NTC: approx. 2,400 increments (12 bits) PTC: approx. 9,900 increments (14 bits)	
	Input Value of LSB	0 to 10V: 0.15mV -10 to +10V: 0.30mV	0 to 20mA: 0.30μA 4 to 20mA: 0.244μA	0.1°C	0.1°C	0.1°C	0.1°C	1Ω
	Data Type in Application Program	Optional: selectable for each channel from -32,768 to 32,767 ¹						
	Monotonicity	Yes						
	Input Data Out of Range	Detectable ²						
Noise Resistance	Input Filter	Software						
	Recommended Cable for Noise Immunity	Twisted pair shielded cable		Twisted pair cable				
	Crosstalk	1 LSB maximum						
Isolation	Between input and power circuit: Transformer-isolated Between input and internal circuit: Photocoupler-isolated							
Effect of Improper Input Connection	No damage							
Maximum Permanent Allowed Overload (No Damage)	13V DC 40mA							
Selection of Input Signal Type and Input Range	Using programming software							
Calibration or Verification to Maintain Rated Accuracy	Not possible							

Note 1: The data processed in the analog I/O module can be linear-converted to a value between -32,768 and 32,767. The optional range designation, and analog I/O data minimum and maximum values can be selected using data registers allocated to analog I/O modules.

Note 2: When an error is detected, a corresponding error code is stored to a data register allocated to analog I/O operating status.

Note 3: R, S: ±6 (0 to 200°C) B: no compensation K, J, E, T, N: ±0.4% of full scale (0°C maximum)

Analog Output Specifications

Part Number		FC6A-K4A1	FC6A-L06A1	FC6A-L03CN1
Output Signal Style/Output Range	Voltage	0 to 10V DC -10 to +10V DC		
	Current	0 to 20mA 4 to 20mA		
Load	Impedance	Voltage output: 1 kΩ minimum Current output: 300Ω maximum		
	Load Type	Resistive load		
DA Conversion	DA Conversion Time	1ms		
	Output Update Interval	1ms		
	Total Output System Transfer Time	DA Conversion Time + Output Update Interval + 1 scan time		
Output Error	Maximum Error at 25°C	±0.2% of full scale	±0.1% of full scale	±0.2% of full scale
	Temperature Coefficient	±0.01%/°C of full scale	±0.006%/°C of full scale	±0.01%/°C of full scale
	Repeatability after Stabilization Time	±0.4% of full scale		
	Output Voltage Drop	No damage		
	Non-linearity	±0.2% of full scale	±0.01%/°C of full scale	±0.2% of full scale
	Output Ripple	20mV maximum		
	Overshoot	0%		
	Total Error	±1% of full scale		
Digital Resolution	4,096 increments (12 bits)			
	Output Value of LSB	Voltage	0 to 10V DC: 2.44mV -10 to +10V DC: 4.88mV	
Current		0 to 20mA: 4.88μA 4 to 20mA: 3.91μA		
Data Type in Application Program	Optional: -32,768 to 32,767 (selected for each channel)			
Monotonicity	Yes			
Current Loop Open	Undetectable			
Noise Resistance	Recommended Cable for Noise Immunity	Twisted pair shielded cable		
	Crosstalk	1LSB		
Isolation	Between output and power circuit	Transformer-isolated		
	Between output and internal circuit	Photocoupler-isolated		
Effect of Improper Output Connection	No damage			
Selection of Analog Output Signal Type	Using software programming			
Calibration or Verification to Maintain Rated Accuracy	Impossible			

Dimensions (all dimensions are in mm)

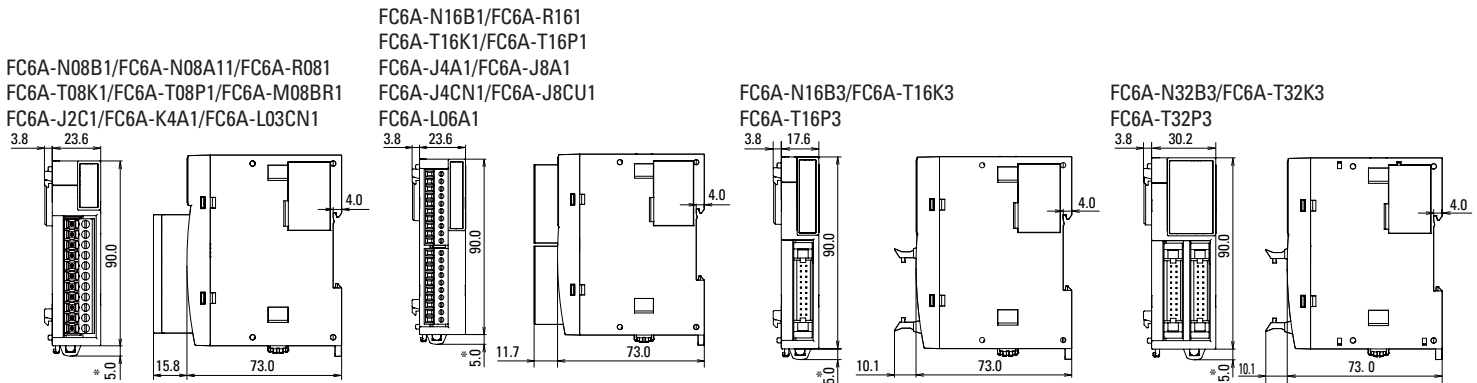

Specifications

Input Range

Part Number	FC6A-F2MR1 FC6A-F2M1		
	Input Range (Digital Resolution)	Input Value of LSB	
K	-200 to 1,370°C	-328 to 2,498°F	1°C (°F)
	-200.0 to 400.0°C	-328.0 to 752.0°F	0.1°C (°F)
J	-200 to 1,000°C	-328 to 1,832°F	1°C (°F)
R	0 to 1,760°C	32 to 3,200°F	1°C (°F)
S	0 to 1,760°C	32 to 3,200°F	1°C (°F)
B	0 to 1,820°C	32 to 3,308°F	1°C (°F)
E	-200 to 800°C	-328 to 1,472°F	1°C (°F)
T	-200.0 to 400.0°C	-328.0 to 752.0°F	0.1°C (°F)
N	-200 to 1,300°C	-328 to 2,372°F	1°C (°F)
PL-II	0 to 1,390°C	32 to 2,534°F	1°C (°F)
C (W/Re5-26)	0 to 2,315°C	32 to 4,199°F	1°C (°F)
Pt100	-200 to 850°C	-328 to 1,562°F	1°C (°F)
	-200.0 to 850.0°C	-328.0 to 1,562.0°F	0.1°C (°F)
JPt100	-200 to 500°C	-328 to 932°F	1°C (°F)
	-200.0 to 500.0°C	-328.0 to 932.0°F	0.1°C (°F)
DC 4 to 20mA	-2,000 to 10,000 (12,000 increments) ¹		1.333µA
DC 0 to 20mA	-2,000 to 10,000 (12,000 increments) ¹		1.666µA
DC 0 to 1V	-2,000 to 10,000 (12,000 increments) ¹		0.083mA
DC 0 to 5V	-2,000 to 10,000 (12,000 increments) ¹		0.416mA
DC 1 to 5V	-2,000 to 10,000 (12,000 increments) ¹		0.333mA
DC 0 to 10V	-2,000 to 10,000 (12,000 increments) ¹		0.833mA

Note 1: Linear-conversion is possible.

Dimensions

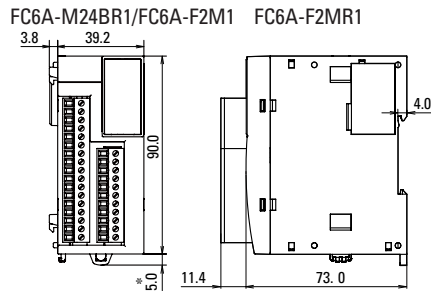

* 9.3 mm when the clamp is pulled out.

MicroSmart FC6A PLC PID Module Specifications

01 Touchscreens



PLCs

Key Features

- Configure up to 15 modules
- Maximum 30 PID loops
- 2 analog inputs and 2 relay or 4-20mA Non-contact voltage output for SSR drive

Ratings

Part Number		FC6A-F2MR1	FC6A-F2M1
Control Mode	Independent PID Control	Possible	
	Heating/Cooling Control	Possible (overlapping deadband settings available) ¹	
	Difference Input Temperature Control	Possible ¹	
	Cascade Control	Possible ¹	
Input Points	2ch		
Input Type Input Range	Thermocouple	K, J, R, S, B, E, T, N, PL-II, C (W/Re5-26) External resistance: 100Ω maximum	
	Resistance Thermometer	Pt100, JPt100, 3-wire type	
	Current Input	0 to 20 mA DC, 4 to 20 mA DC Input impedance: 50Ω	
	Voltage Input	0 to 1V DC Input impedance: 1MΩ minimum 0 to 5V DC, 1 to 5V DC, 0 to 10V DC Input impedance: 100kΩ minimum	
AD Conversion	Sampling Duration Time	100 ms	
	Sampling Repetition Time	100 ms	
	Total Input System Transfer Time	Sampling time + sampling interval + 1 scan time	
	Type of Input	Differential input	
Conversion Method	Σ Δ type ADC		
Maximum Error at 25°C	Thermocouple Input	±0.2% of full scale or ±2°C (4°F), whichever is greater However, R, S inputs: 0 to 200°C (0 to 400°F): ±6°C (12°F) B input: 0 to 300°C (0 to 600°F) Accuracy is not guaranteed. K, J, E, T, N inputs: Less than 0°C (32°F): ±0.4% of full scale	
	Resistance Thermometer Input	±0.1% of full scale or ±1°C (2°F), whichever is greater	
	Voltage/Current Inputs	±0.2% of full scale	
Cold Junction Temperature Compensation Accuracy	±1°C at 0 to 55°C		
Temperature Coefficient	±0.005%/°C of full scale		
Noise Resistance	Input Filter	Yes	
	Recommended Cable for Noise Immunity	Twisted pair shielded cable (current/voltage) / Twisted pair cable (temperature input)	
	Cross Talk	None	
Isolation	Between input and power circuit	Transformer-isolated	
	Between input and internal circuit	Photocoupler-isolated	
Output Points	2ch		
Output	Relay output 1NO Rated load 5A 250V AC/30V DC (resistive load) 3A 250V AC (inductive load cos φ=0.4) 3A 30V DC (resistive load VR=7ms) Minimum open/closed load: 10 mA 5V DC (reference value) Electrical life: 100,000 cycles (at the maximum rating of resistive load)	Non-contact voltage output (for SSR drive) 12V DC±15% Maximum 40 mA (short circuit protected) Analog current output 4 to 20 mA DC Load resistance: 550Ω maximum Analog output digital resolution: 1,000 LSB input value: 0.016 mA	
	Recommended Cable for Noise Immunity	—	Twisted pair shielded cable
Noise Resistance	Cross Talk	—	None
	Isolation	Between input and power circuit: Transformer-isolated Between input/output and internal circuits: Photocoupler-isolated Between input circuits: Photocoupler-isolated	
Power Voltage	24V DC (External power), 5V DC (Internal power)		
Allowable Voltage Range	20.4 to 28.8V DC		
Maximum Power Consumption	3.6W		
Internal Power Consumption	65mA (5V DC)		
Weight (approx.)	140g		

Note 1: Dual channel input is required for one loop control.

Automation Software

Power Supplies

Sensors

Communication

Barriers

MicroSmart FC6A PLC HMI and Communication Adapter Specifications



Key Features

- Add 2nd Ethernet port
- Add additional serial port
- HMI module supports User Web Page
- HMI module supports Web Server Functions
- HMI module supports Email and Text Message notifications

HMI Module Specifications

General Specifications

Part Number	FC6A-PH1
Power Consumption Inside Module (without connection cartridge)	100mA (5V) 1.5mA (24V)
Cartridge (option)	One analog cartridge can be added
Weight (approx.)	170g

Display Specifications

Part Number		FC6A-PH1
Display		TFT Monochrome LCD
Color/Shade		Monochrome
Effective Display Area		47.98W × 8.22H mm
Display Resolution		192W × 64H pixels
View Angle		Right and left 30°, up 20°, down 40°
Contrast adjustment		Impossible
Backlight		LED (green)
Brightness		45 cd/m ²
Brightness Adjustment		Impossible
Backlight Control		ON/OFF
Backlight Replacement		Impossible
Display Character Size	1/2 size	8 × 16 pixels (JIS 8-bit code, Western European language ISO 8859-1, Cyrillic ANSI1251)
	Full size	16 × 16 pixels (Japanese JIS first level characters, simplified Chinese)
Quantity of Characters	1/2 size	24 characters × 4 lines
	Full size	12 characters × 4 lines
Character Attribute		Blink, reverse,

Communication Adapter

Part Number		FC6A-PC1	FC6A-PC3
Standards		EIA RS232C	EIA RS485
Maximum Baud Rate		—	115,200bps
Maintenance Communication		Possible	Possible
User Communication		Possible	Possible
Data Link Communication		—	Possible
Half-duplex Communication		—	Possible
Maximum Cable Length		5m	200m
Quantity of Slave Stations		—	31
Isolation between Internal Circuit and Communication Port		Not isolated	
RS485 Cable	Cable	3-core shielded cable with a minimum core wire of 0.3 mm ²	
	Conductor Resistance	85 Ω/km maximum	
	Shield Resistance	20 Ω/km maximum	

Operation Specifications

Part Number	FC6A-PH1
Operation Method	Rubber Switch
Operating Force	2.0N minimum
Mechanical Life	10,000 operations
Multiple Operation	Possible

HMI Ethernet Port Specifications

Part Number	FC6A-PH1	
Communication	Complies with IEEE802.3	
Transmission speed	10BASE-T, 100BASE-TX	
Protocol	Datalink layer: IP/ARP Network layer: TCP/UDP, ICMP Application layer: DHCP, DNS, HTTP, SMTP	
Connector	RJ45	
Cable	CAT 5. STP	
Maximum Cable Length	100m	
Isolation from Internal Circuit	Pulse transformer isolation	
Major Functions	Remote Maintenance	Uploading, downloading and monitoring using WindLDR Number of connections: 8
	Web Server	Page data of 5MB maximum (total of system web page and user web page) can be stored. (System web page: approx. 450 KB) Number of connections: 8 maximum Authentic method: digest authentication
	Send E-mail	Sends preregistered e-mails. Up to 255 types of e-mails can be sent. Authentic method: SMTP-Auth (login), SMTP-Auth (CRAM-MD5), SMTPs Encoding method: BASE64
E-mail Size	The maximum size of texts for To or Cc is 512 bytes. ¹ E-mail subject: 255 bytes maximum E-mail body: 4096 bytes maximum Attached CSV file: 4096 bytes maximum (includes spaces, separator characters, and newlines)	

Note 1: Comma (,) is inserted as a separating character between e-mail addresses.

Dimensions

FC6A-PH1

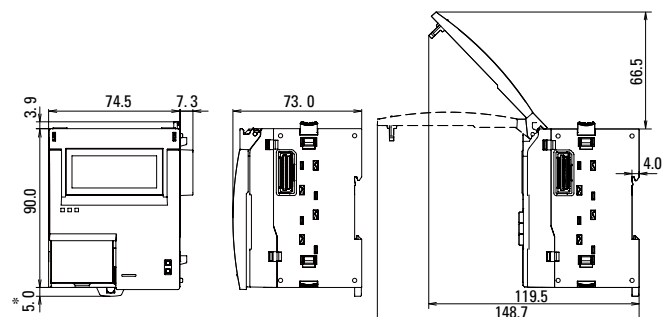

IO Touchscreens

PLCs

Automation Software

Power Supplies

Sensors

Communication

Barriers

MicroSmart FC6A PLC Expansion Interface Module Specifications

01 Touchscreens

PLCs

Automation Software

Power Supplies

Sensors

Communication

Barriers



Key Features

- Required when expanding to more than 7 expansion modules
- Allows FC6A to expand an additional 8 expansion modules

Expansion Interface Module Specifications

Part Number		FC6A-EXM2
Rated Power Voltage		24V DC
Allowable Voltage Range		20.4 to 28.8V DC
Power Consumption		Internal power (supplied from CPU module): 20 mA (5V DC), 0 mA (24V DC) External power: With I/O modules ¹ 750 mA (26.4V DC)
Maximum Power Consumption (External Power) ¹		0.5W (24V DC)
Allowable Momentary Power Interruption		10ms minimum (24V DC)
I/O Expansion		Between CPU module and expansion interface module Connectable I/O modules: 7 maximum (224 I/Os maximum) Beyond the expansion interface module Connectable I/O modules: 8 maximum (256 I/Os maximum)
Isolation from Internal Circuit		Not isolated
Connector	Insertion/Removal Durability	100 times minimum
	Applicable Ferrules	1-wire: AI 0.5-10 (Phoenix Contact) 2-wire: AI-TWIN 2x0.5-10 (Phoenix Contact)
Weight (approx.)		150g

Note 1: Power consumption by the expansion interface module and eight I/O modules.

Dimensions (all dimensions are in mm)

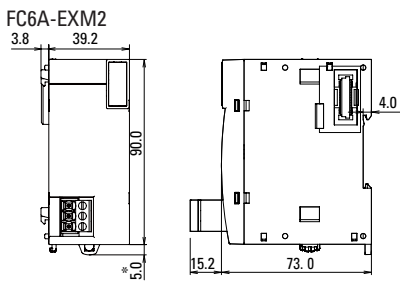



**The Power to Control.
Anywhere. Anytime.**

Power, Performance, Connectivity

Maximize efficiency and cut development time! MicroSmart Pentra PLCs combine advanced networking capabilities with unparalleled power, performance and connectivity. Designed to meet all your communication requirements, now and in the future, MicroSmart Pentra PLCs give you the flexibility to expand your system with as many as fifteen modules! Our new Embedded Ethernet PLC with built-in Modbus TCP also lets you remotely monitor status in real-time, receive email alerts and customize your own web page.

Safety

All MicroSmart Pentra PLCs meet the highest standards for safety including: cULus listed for Class 1 Division 2 hazardous locations*, CE compliant, as well as certified for marine use by ABS, DNV, and Lloyd's Registry*.



*Not applicable for all models. Visit www.IDEC.com/approvals for details.

The MicroSmart Pentra PLC Family: Everything you need in a controller

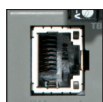

Embedded Ethernet Port

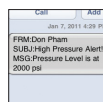

Email and text notifications



Modbus TCP, RTU and ASCII



USB programming port

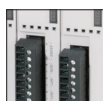

Seven communication ports



NEW Advanced PID control modules



User web page

Battery-less models

OT Touchscreens

PLCs

Automation Software

Power Supplies

Sensors

Communication

Barriers

MicroSmart Pentra Performance

Embedded Ethernet Port

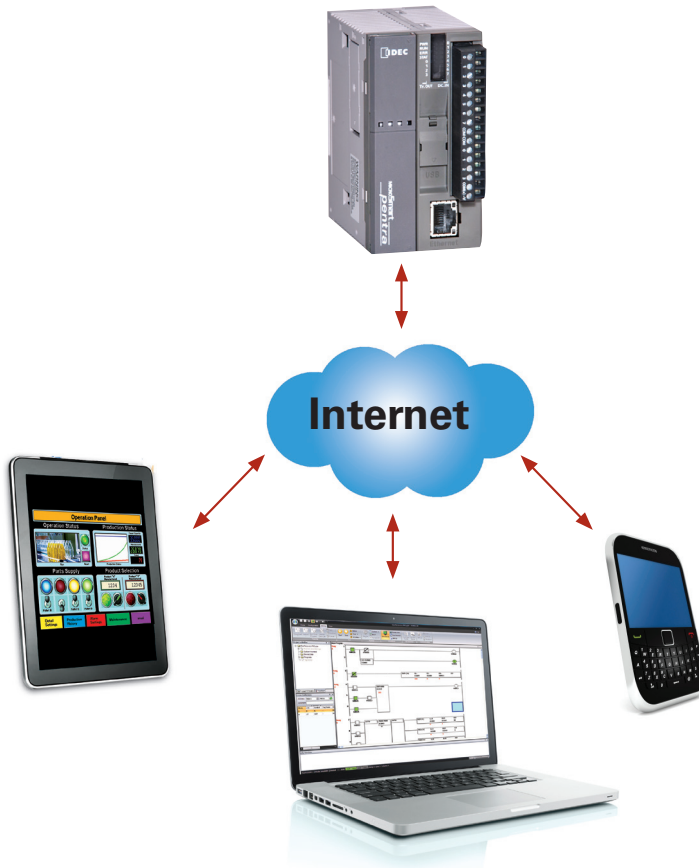

Remote Access and Control

The new MicroSmart Pentra PLC with an embedded Ethernet port, you can configure the MicroSmart Pentra PLC for remote monitoring and control. Using WindLDR software, you can remotely monitor or update the PLC programs without having to be near the PLC.

Web Server Functions

Using standard web browsers like Internet Explorer or Firefox, you can remotely log-in and access web pages that are stored directly on the MicroSmart Pentra PLC. Up to 1 MB of memory is dedicated for web page storage! Use the built-in web pages or create your own using an HTML editor.

14 Simultaneous Connections

The new embedded Ethernet Pentra supports up to 14 simultaneous connections through its Ethernet port. Through the Ethernet port, the embedded Ethernet Pentra can be configured to communicate to WindLDR for maintenance communications, to an Operator Interface touchscreen, and to VFD using Modbus TCP communications, all simultaneously.

Embedded USB Maintenance Port

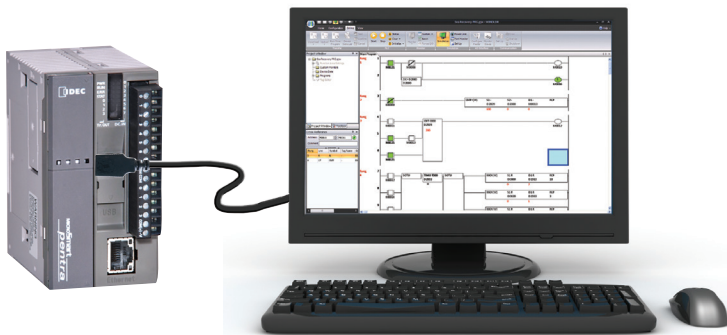

The new MicroSmart Pentra PLC with an embedded Ethernet PLC port also has an embedded mini-B USB port for maintenance.

You can now easily connect your PC to this PLC using a standard USB cable.



OI Touchscreens

PLCs

Automation Software

Power Supplies

Sensors

Communication

Barriers

Modbus TCP, RTU and ASCII

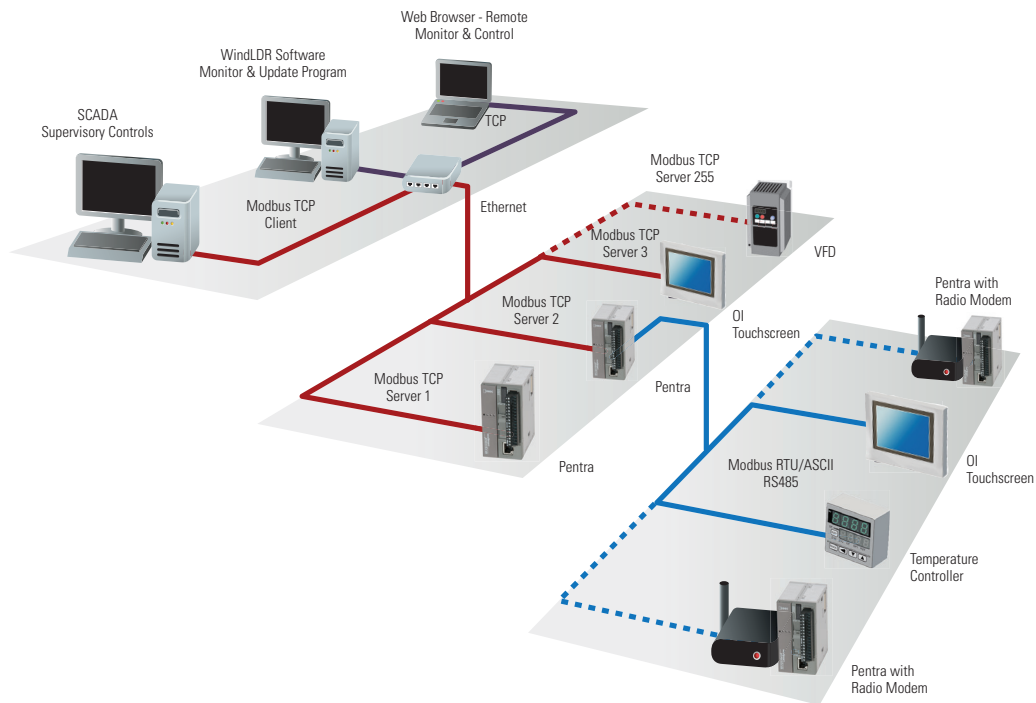

Using intuitive WindLDR software, you can configure the MicroSmart Pentra to be a Master or Slave device on a Modbus network. All MicroSmart Pentra PLCs support Modbus RTU/ASCII protocols and our CPU with embedded Ethernet port also supports Modbus TCP protocol.

Email and Text Message



Easily configure the MicroSmart Pentra PLCs to send out system status and alarms to your email or mobile phone. Data registers values in the PLC can also be incorporated in the body of the email. It also supports email login authentication so third party email server like Yahoo can be used. Up to 255 email templates can be configured with multiple recipients can be included.

IO Touchscreens

PLCs

Automation Software

Power Supplies

Sensors

Communication

Barriers

User Web Pages

OI Touchscreens

PLCs

Automation Software

Power Supplies

Sensors

Communication

Barriers



With IDEC MicroSmart Pentra, users do not need to know JAVA programming to embed dynamic values and parts on their PLC web pages. Even novice HTML programmer can take full advantage of the integrated IDEC system library of numerical display/input, horizontal and vertical bar graphs, trend chart, ON/OFF pilot lights and pushbuttons. Up to 1MB of memory is reserved for user web pages.

Integrated 100KHz Fast Inputs and Outputs

Configure up to four high-speed inputs from high-speed output devices such as rotary encoders or proximity switches at a maximum frequency of 100KHz, independent of the scan time. Up to three high-speed outputs can be used for simple positioning controls for stepper or servo motors.

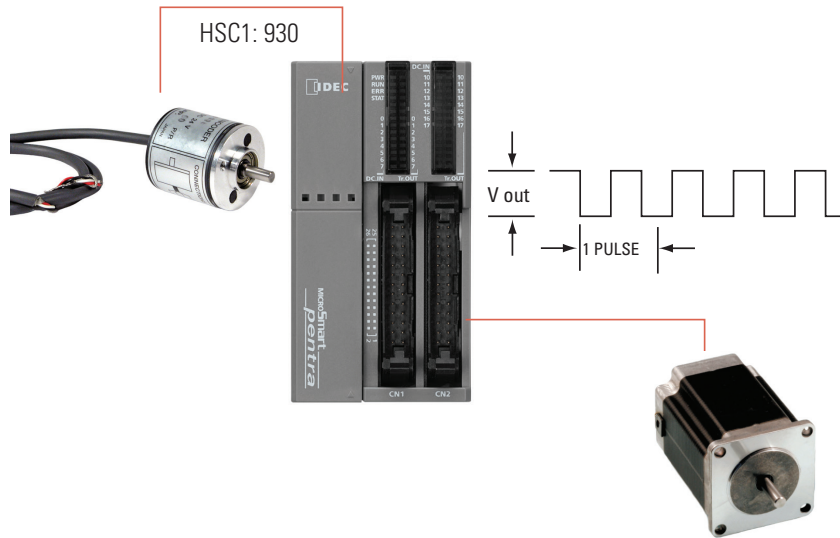

Maximum 7 Communication Ports



With MicroSmart Pentra PLCs, you don't have to worry about limited communication capabilities. It doesn't matter if you're just starting out or a current user expanding your MicroSmart Pentra PLC, you can rest assured that these communication modules will provide reliable and seamless communication. If RS485 modules are used for all six ports, up to 186 RS485 slave devices can be connected with as high as a 115K baud rate available for fast transmission.

Battery-less CPUs

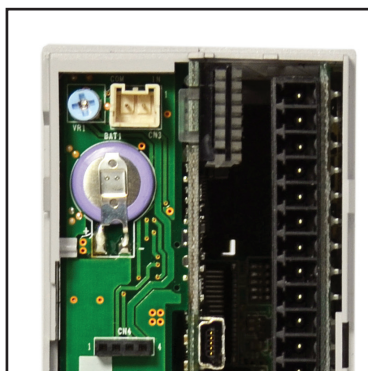

With most PLCs, dynamic values are stored and backed up by a rechargeable lithium battery. In most instances, this battery can only back up data for up to 30 days when the PLC is not powered, otherwise all data will be reset. Not only that, but most lithium battery only last up to 5 years. In that case the battery needs to be replaced or in some cases the entire unit. Now, thanks to the MRAM memory designed into our new FC5A controllers, these limitations are a thing of the past! Values can be stored permanently to eliminate the hassle and worry of losing dynamic and preloaded data. This makes them ideal for applications that need to retain critical data permanently.

OT Touchscreens

PLCs

Automation Software

Power Supplies

Sensors

Communication

Barriers

Choose a CPU for every application

With three controller types to choose from, MicroSmart Pentra PLCs offer the features you need for your applications. Built to allow you the flexibility to expand when you need to, MicroSmart Pentra PLCs are the best way to get everything you need in just one controller.

01 Touchscreens

PLCs

Automation Software

Power Supplies

Sensors

Communication

Barriers

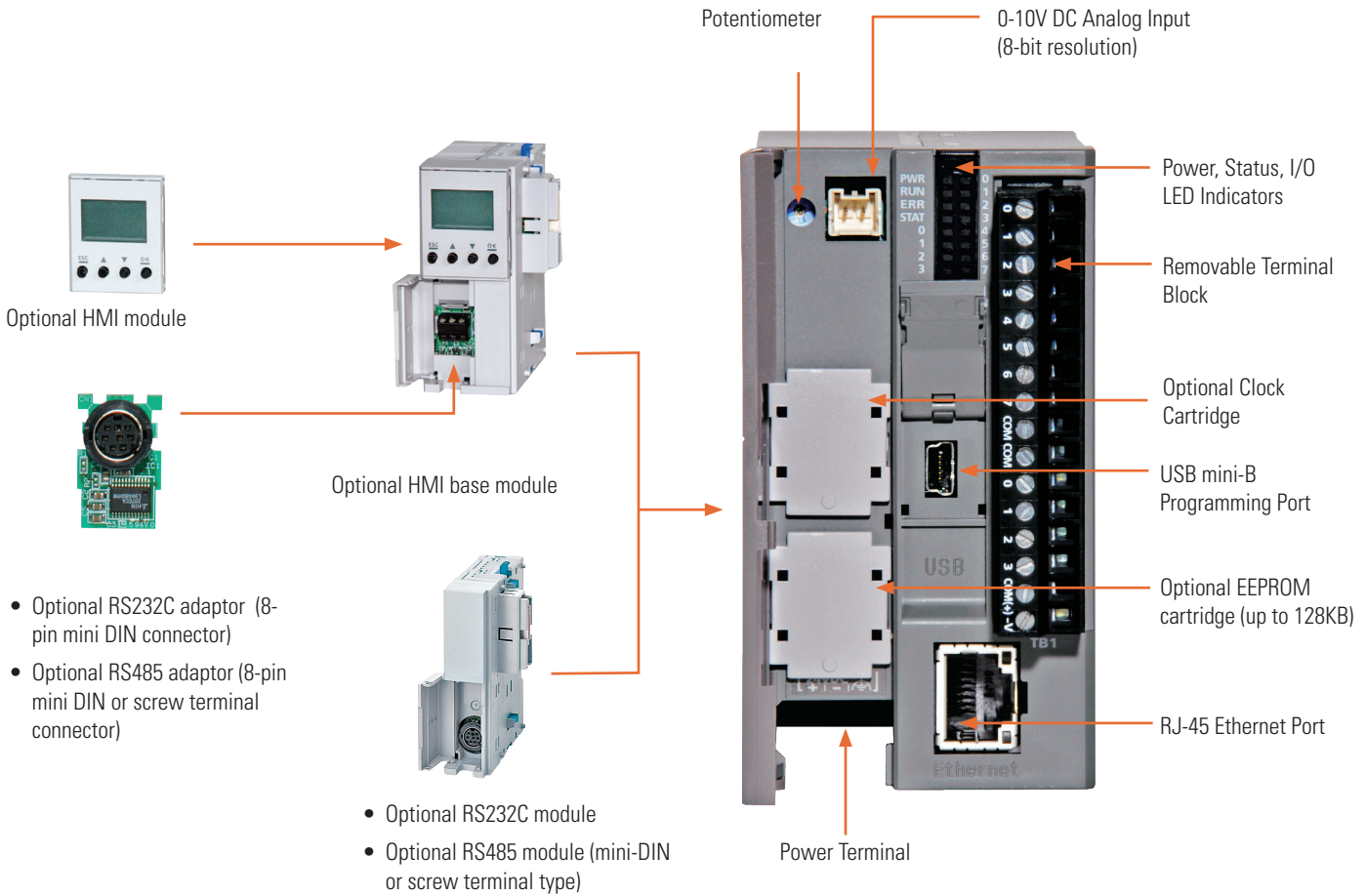

Slim CPU with Ethernet Port

The perfect design when you need Ethernet capability, this slim CPU with embedded Ethernet port is available with 24V DC power and equipped with eight DC inputs and four transistor outputs (sink or source). Up to seven functional modules, including analog and communication modules can be mounted on the right-hand expansion bus. Using an expansion interface module, an additional eight discrete expansion modules can be mounted.

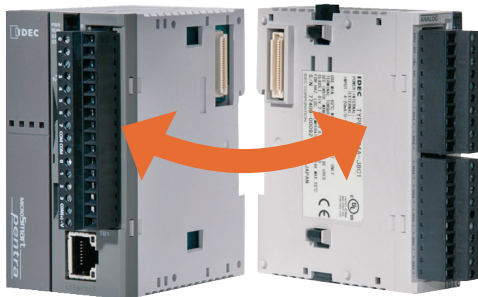

Modules snap together easily without the need for additional tools.

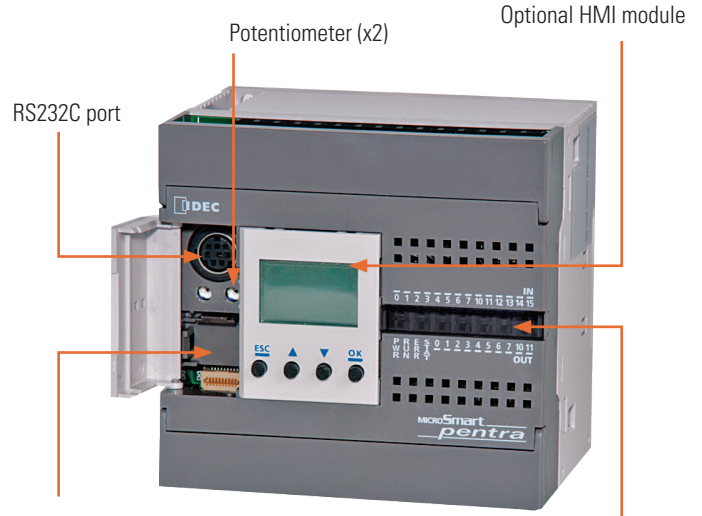
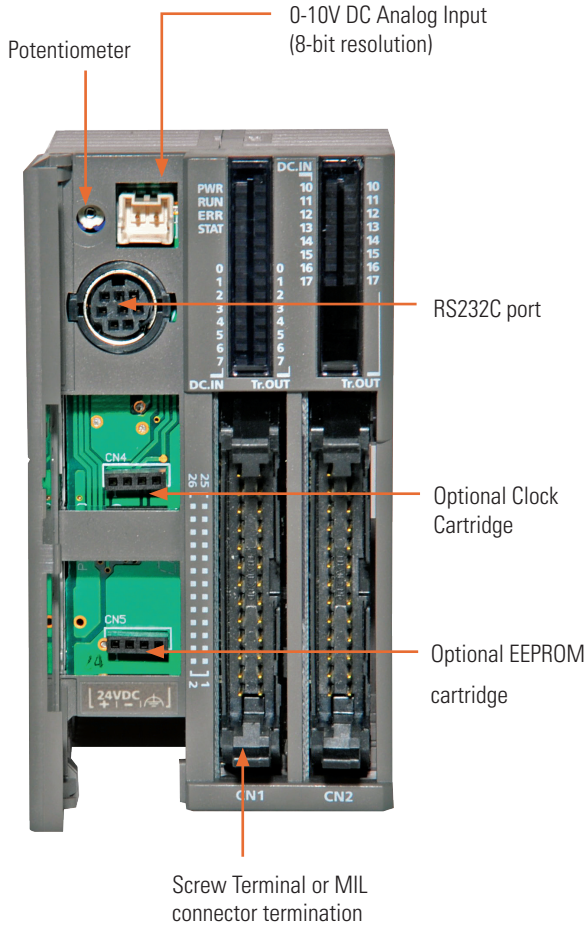

- Optional RS232C adaptor (8-pin mini DIN connector)
- Optional RS485 adaptor (8-pin mini DIN or screw terminal connector)

Power, Status, I/O LED Indicators



- Optional EEPROM cartridge
- Optional Clock Cartridge



Slim CPU

If you don't need Ethernet, but still want a high-performance CPU, the MicroSmart Pentra slim CPU is your best choice! Available with 24V DC power, this controller has all the functionalities you need in 16 and 32 I/O configurations. Each 16 I/O CPU is equipped with eight DC inputs, two transistor outputs (sink or source) and six relay outputs, while the 32 I/O CPU is equipped with 16 DC inputs and 16 transistor outputs (sink or source).

All-in-One CPU

Available with 12V DC, 24V DC and 100-240V AC power, you can choose from 10, 16 and 24 I/O configurations. The 10 I/O CPU is equipped with six DC inputs and four relay outputs, while the 16 I/O CPU is equipped with nine DC inputs and seven relay outputs. The 24 I/O CPU is equipped with 14 DC inputs and ten relay outputs. The 24 I/O CPU (24V DC and 100-240V AC models) can also be expanded with a maximum of four functional or discreet expansion modules.

IO Touchscreens

PLCs

Automation Software

Power Supplies

Sensors

Communication



Barriers

MicroSmart Pentra CPU Part Numbers



Slim Base Module with Embedded Ethernet

Style	Part Number	Permanent Data Backup	Embedded I/Os	Operating Voltage	Ethernet & USB Port	Output	Maximum No. of Expansion Modules
	FC5A-D12K1E	—	12 (8in/4out)	24V DC	Yes	Transistor Sink	15 (Maximum 492 digital I/Os)
	FC5A-D12S1E	Yes				Transistor Source	
	FC5A-D12K1E-DS0838					Transistor Sink	
	FC5A-D12S1E-DS0838					Transistor Source	

Slim Base Module

Style	Part Number		Operating Voltage	Ethernet & USB Port	Output	Maximum No. of Expansion Modules
	FC5A-D16RK1	16 (8in/8out)	24V DC	—	6 Relays, 2 Trans. Sink	15 (Maximum 496 digital I/Os)
	FC5A-D16RS1				6 Relays, 2 Trans. Source	
	FC5A-D32K3	32 (16in/16out)			Transistor Sink	15 (Maximum 512 digital I/Os)
	FC5A-D32S3				Transistor Source	

All-in-One Base Module

Style	Part Number		Operating Voltage	Ethernet & USB Port	Output	Maximum No. of Expansion Modules
	FC5A-C10R2	10 (6in/4out)	120-240V AC	—	Relay	—
	FC5A-C10R2C		24V DC			
	FC5A-C10R2D		12V DC			
	FC5A-C16R2	16 (9in/7out)	120-240V AC	—	Relay	—
	FC5A-C16R2C		24V DC			
	FC5A-C16R2D		12V DC			
	FC5A-C24R2	24 (14in/10out)	120-240V AC	—	Relay	4 (Maximum 88 digital I/Os)
	FC5A-C24R2C		24V DC			
	FC5A-C24R2D		12V DC			

01 Touchscreens

PLCs

Automation Software

Power Supplies

Sensors

Communication

Barriers

MicroSmart Performance

Key features:

- Available in 10, 16, 20, 24, and 40 I/O CPUs.
- PID Controls
 - Program up to 14 PID loops
- High Speed I/O
 - Built-in 4 high speed inputs
 - Single or Dual Phase
 - Max. 20KHz frequency
- Built-in 2 High speed outputs (Slim model only)
- Configure up to 264 I/O Points
- Data link up to 32 MicroSmart and Pentra CPUs
- Using RS485 communication module/port, you can create a network of up to 32 CPUs.
- Worldwide Approvals
 - cULus listed, CE marked
 - Class 1 Div. 2 for hazardous locations
 - Lloyds Registered and ABS approved for shipping industry



MicroSmart CPU Part Numbers

All-in-One

Style	Part Number	Power	I/O Points	Input	Output	Maximum No. of Expansion Modules			
	FC4A-C10R2C	24V DC	10 (6 in/ 4 out)	24V DC (Sink/Source)	Relay	-			
	FC4A-C10R2	100-240V AC							
	FC4A-C16R2C	24V DC	16 (9 in/ 7 out)						
	FC4A-C16R2	100-240V AC							
	FC4A-C24R2C	24V DC	24 (14 in/ 10 out)				-	-	4 (Maximum 88 digital I/Os)
	FC4A-C24R2	100-240V AC							

I/O Touchscreens

PLCs

Automation Software

Power Supplies

Sensors

Communication

Barriers

MicroSmart CPU Part Numbers

Slim

Style	Part Number	Power	I/O Points	Input	Output	Maximum No. of Expansion Modules
	FC4A-D20RK1	24V DC	20 (12 in/8 out)	24V DC (Sink/Source)	6 Relays, 2 Transistor Sink	7 (Maximum 244 digital I/Os)
	FC4A-D20RS1				6 Relays, 2 Transistor Source	
	FC4A-D20K3				Transistor Sink	7 (Maximum 148 digital I/Os)
	FC4A-D20S3				Transistor Source	
	FC4A-D40K3				40 (24 in/16 out)	7 (Maximum 264 digital I/Os)
	FC4A-D40S3					

01 Touchscreens

PLCs

Automation Software

Power Supplies

Sensors

Communication

Barriers

Digital I/O Expansion Modules

Key features:

- 15 modules to choose from
- Available with Screw or MIL connectors
- Easy snap-on
- Available 8, 16 or 32 point modules
- Up to 512 I/O can be configured in the Pentra and 264 I/O in the MicroSmart system

Input Modules

Style	Part Number	Input	Input Points	Terminal
	FC4A-N08A11	100-120V AC	8	Removable Screw Terminals
	FC4A-N08B1			
	FC4A-N16B1	24V DC	16	MIL Connector (ribbon cable)
	FC4A-N16B3			
	FC4A-N32B3			

01 Touchscreens

PLCs

Automation Software

Power Supplies

Sensors

Communication

Barriers

Digital I/O Expansion Modules

OI Touchscreens

PLCs

Automation Software

Power Supplies

Sensors

Communication



Barriers

Output Modules



Style	Part Number	Output	Output Points	Terminal
	FC4A-R081	Relay	8	Removable Screw Terminals
	FC4A-R161		16	
	FC4A-T08K1	Transistor Sink	8	MIL Connector (ribbon cable)
	FC4A-T16K3		16	
	FC4A-T32K3		32	

Digital I/O Expansion Modules

Output Modules (cont.)

Style	Part Number	Output	Output Points	Terminal
	FC4A-T08S1		8	Removable Screw Terminals
	FC4A-T16S3	Transistor Source	16	MIL Connector (ribbon cable)
	FC4A-T32S3		32	

Combination I/O Modules

Style	Part Number	Input	Output	I/O Points	Terminal
	FC4A-M08BR1	24V DC (Sink/Source)	Relay	8 (4 in/4 out)	Removable Screw Terminals
	FC4A-M24BR2			24 (16 in/ 8 out)	Wire Spring Clamp

I/O Touchscreens

PLCs

Automation Software

Power Supplies

Sensors

Communication

Barriers

Analog I/O Expansion Modules

Key features:

- 9 different modules to choose from
- 0-10V, 4-20mA, RTD, Thermocouple, Thermistor inputs, 0-10V DC or -10V DC to 10V DC output
- 12 or 16-bit resolution
- Fast conversion time
- Maximum of 56 I/O can be configured in the MicroSmart Pentra system
- Easy to configure using a Macro instruction in WindLDR

Modules

Style	Part Number	I/O Points	Input	Output	Resolution	Terminal
	FC4A-J8C1	8 (8 inputs)		–	16-bit (0-50000)	
	FC4A-L03A1	3 (2 inputs, 1 output)	0-10V DC, 4-20mA	0-10V DC, 4-20mA	12-bit (0-4095)	
	FC4A-J2A1	2 (2 inputs)		–		Removable Screw Terminals
	FC4A-J4CN1	4 (4 inputs)	0-10V DC, 4-20mA, RTD, Thermocouple	–	16-bit (0-50000)	
	FC4A-L03AP1	3 (2 inputs, 1 output)	RTD, Thermocouple	0-10V DC, 4-20mA	12-bit (0-4095)	

OI Touchscreens

PLCs

Automation Software

Power Supplies



Sensors

Communication

Barriers

Analog I/O Expansion Modules

Modules (cont.)

Style	Part Number	I/O Points	Input	Output	Resolution	Terminal
	FC4A-J8AT1	8 (8 inputs)	Thermistor (NTC/PTC)	–	12-bit (0-4000)	
	FC4A-K2C1	2 (2 outputs)	–	-10 to 10V DC, 4-20mA	16-bit (0-50000)	Removable Screw Terminals
	FC4A-K1A1	1 (1 output)	–	0-10V DC, 4-20mA	12-bit (0-4095)	
	FC4A-K4A1	4 (4 outputs)				

Communication Modules Web Server Module

Features:

- Easy to configure
- Comes with interface cable and Quick Start Guide

Part Numbers

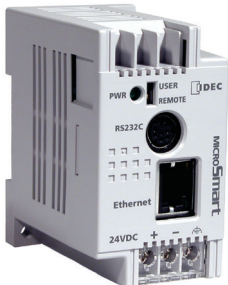
Style	Part Number	Description
	FC4A-ENET	Web Server Module (includes cable and Quick Start Guide)

Style	Part Number	Description
	FC9Y-QS100-0	Quick Start Guide

I/O Touchscreens

PLCs

Automation Software

Power Supplies

Sensors

Communication

Barriers

Advanced PID for precision control

PID (Proportional Integral Derivative) is the most commonly used feedback control loop in industrial control systems. PID calculates an error value as the difference between a measured process variable and a desired set point. The controller then attempts to minimize the error by adjusting the process control. With MicroSmart Pentra PLCs, PID implementation can be deployed in two ways: integrated PID controls or a dedicated Process Control module, which can be mounted on the MicroSmart Pentra expansion bus.

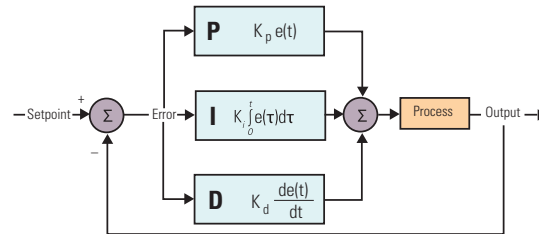

Advanced PID Control Module Part Numbers

Style	Part Number	Description
	FC5A-F2M2	PID Control Module with 2x analog inputs and 2x 4-20mA/non-contact voltage for SSR drive
	FC5A-F2MR2	PID Controls Module with 2x analog inputs and 2x Relay Outputs

Advanced PID Control Module

A dedicated PID Control module is available for extreme stability and complex applications. This particular module has more functionalities than you will find in any other controller on the market. Independent of CPU scan time, the PID Control module does the work, reducing PLC scan time without taking up PLC memory space.

PID Control Module Highlights:

- Precise, stable and accurate PID control with less than a 0.2% error
- Available in two models:
 - Built-in 2 analog inputs, 2 x 4-20mA/ non-contact voltage for SSR drive
 - Built-in 2 analog inputs, 2 x relay outputs
- Each input individually configured to accept different signal types
- Up to seven modules can be mounted on the MicroSmart Pentra
- Maximum 14 PID loops with auto-tuning
- 14-bit resolution
- ARW (anti-reset windup)
- Accepts many different input types including:
 - Type K, J, R, S, B, E, T, C, PL-II and N thermocouples
 - RTD
 - 0-20 mA and 4-20 mA
 - 0-1V, 0-5V, 1-5V, and 0-10V DC
- Numerous control methods including:
 - Cascade
 - External set point
 - Heating and cooling control action
 - Difference input control



OT Touchscreens

PLCs

Automation Software

Power Supplies

Sensors

Communication

Barriers

Communication Module

Style	Part Number	Description
	FC5A-SIF4	RS485 Communication Module for MicroSmart Pentra configure as port 3 to 7
	FC5A-SIF2	RS232 Communication Module for MicroSmart Pentra configure as port 3 to 7

Communicate with up to seven different serial devices

Only IDEC offers communication modules that enable you to configure up to seven serial devices! Now you can connect your operator interface, PC, barcode reader, RFID equipment, printer and more. Just imagine the possibilities.

Using the MicroSmart Pentra slim CPU, you can configure up to seven communication ports. Using the All-in-one MicroSmart Pentra you can communicate with up to five serial devices.



OT Touchscreens

PLCs

Automation Software

Power Supplies

Sensors

Communication

Barriers

Optional Modules

01 Touchscreens

PLCs





Automation Software

Power Supplies

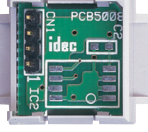

Sensors

Communication

Barriers

Style	Part Number	Description	Usage
	FC4A-HPH1	HMI Base Module	For mounting HMI module and communication ports with slim model CPU module (HMI module is not included)
	FC4A-PH1	HMI Module	For displaying and changing operands
	FC4A-PM32	EEPROM memory cartridge	32KB EEPROM memory cartridge
	FC4A-PM64	EEPROM memory cartridge	64KB EEPROM memory cartridge
	FC4A-PM128	EEPROM memory cartridge	128KB EEPROM memory cartridge
	FC4A-PT1	Clock cartridge	Real-time clock cartridge

Communication Ports

Style	Part Number	Description	Terminal
	FC4A-PC1	RS232C	Mini DIN
	FC4A-PC2	RS485	Mini DIN
	FC4A-PC3	RS485	Screw Terminal

Communication Module — for Slim CPU

Style	Part Number	Description	Terminal
	FC4A-HPC1	RS232C	Mini DIN
	FC4A-HPC2	RS485	Mini DIN
	FC4A-HPC3	RS485	Screw Terminal

Expansion Power Supply Module

Style	Part Number	Description
	FC5A-EXM1M	Master Expansion Power Supply For MicroSmart Pentra
	FC5A-EXM1S	Slave Expansion Power Supply For MicroSmart Pentra
	FC5A-EXM2	Expansion Power Supply For MicroSmart Pentra

Expansion Power Supply System Configuration

FC5A-EXM2 (Expansion Interface Module)

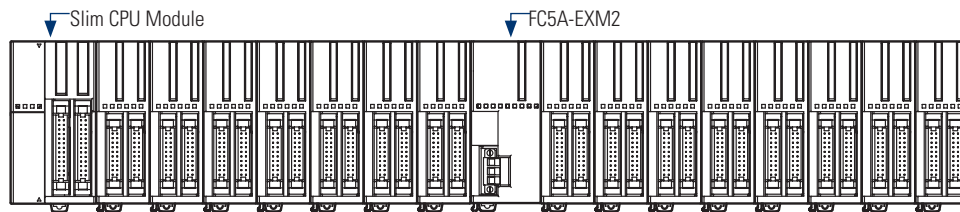

FC5A-EXM1M and FC5A-EXM1S (Expansion Interface Master & Slave Modules)

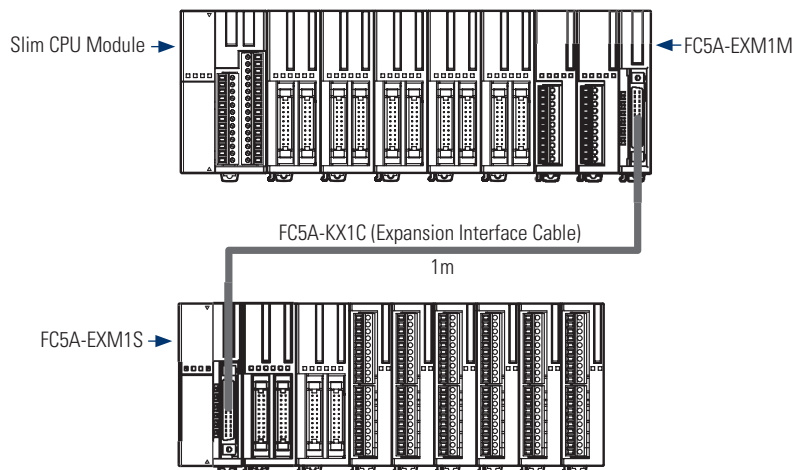

Cables

01 Touchscreens

PLCs

Automation Software

Power Supplies



Sensors

Communication

Barriers

Communication Cables

Appearance	Part Number	Length	Expanded Description
	FC4A-KC4CA	5ft. (1.53m)	Programming cable (Maintenance/User Communication Mode selectable)
	FC4A-USB	6ft. (1.83m)	USB to Serial Converter
	FC4A-KC3C	0.33ft. (100mm)	Web Server Module interface cable
	HG9Z-XCM2A	6ft. (1.83m)	USB programming cable for embedded Ethernet CPU



Appearance	Part Number	Length	Expanded Description
	FC2A-KM1C	9.84 Ft. (3m)	Modem cable. Used to connect a modem to the MicroSmart RS232C port.
	FC2A-KP1C	9.84 Ft. (3m)	User communication cable. Used to connect RS232C equipment to the MicroSmart RS232C port.
	FC5A-KX1C	3.28 Ft. (1m)	MicroSmart Pentra expansion power supply interface cable. Used to connect expansion interface master and expansion slave modules.

MIL Connector Cables (use with Breakout Modules)

Use with	Part Number	Model	Length
CPU Module (26-wire) BX1D-S26A, BX1D-T26A	FC9Z-H050B26	Non-shielded	1.64ft. (0.5m)
	FC9Z-H100B26		3.28ft. (1m)
	FC9Z-H200B26		6.56ft (2m)
	FC9Z-H300B26		9.85ft. (3m)
	FC9Z-H050A26	Shielded	1.64ft. (0.5m)
	FC9Z-H100A26		3.28ft. (1m)
	FC9Z-H200A26		6.56ft (2m)
	FC9Z-H300A26		9.85ft. (3m)
FC9Z-H100C26A	Shielded Single Connectors	5ft. (1.5m)	

Use with	Part Number	Model	Length
I/O Expansion Modules (20-wire) BX1D-S20A, BX1D-T20A	FC9Z-H050B20	Non-shielded	1.64ft. (0.5m)
	FC9Z-H100B20		3.28ft. (1m)
	FC9Z-H200B20		6.56ft (2m)
	FC9Z-H300B20		9.85ft. (3m)
	FC9Z-H050A20	Shielded	1.64ft. (0.5m)
	FC9Z-H100A20		3.28ft. (1m)
	FC9Z-H200A20		6.56ft (2m)
	FC9Z-H300A20		9.85ft. (3m)
	FC9Z-H100C20A	Shielded Single Connectors	5ft. (1.5m)

Breakout Modules

Use with	Part Number	Description
26-wire MIL connector cable 	BX1D-S26A	26-terminal breakout module
	BX1D-T26A	26-terminal touch-down terminal breakout module
20-wire MIL connector cable 	BX1D-S20A	20-terminal breakout module
	BX1D-T20A	20-terminal touch-down terminal breakout module

Accessories

FC4A-PMT13	CPU module	13-position left-side terminal block for FC4A-D20RK1/-D20RS1 CPU
FC5A-PMT13		13-position left-side terminal block for FC5A-D16RK1/-D16RS1 CPU
FC4A-PMTS16		16-position right-side terminal block for FC4A-D20RS1 and FC5A-D16RS1 CPU
FC4A-PMTK16		16-position right-side terminal block for FC4A-D20RK1 and FC5A-D16RK1 CPU
FC4A-PMT11		11-position terminal block for 8-pt I/O expansion modules
FC4A-PMT10	I/O expansion modules	10-position terminal block for 16-pt I/O expansion modules
FC4A-PMC20		20-position connector socket for MIL connector I/O expansion modules
FC4A-PMC26		26-position connector socket for MIL connector CPU modules
FC4A-PSP1		Direct mounting strips for mounting on a panel
FC4A-PMAC2		Analog voltage input cable for slim CPU
FC4A-DS824-SW14		14-pt input simulator switch for 24 I/O CPU
FC4A-DS824-SW9		9-pt input simulator switch for 16 I/O CPU
FC4A-DS824-SW6		6-pt input simulator switch for 10 I/O CPU
FC9Y-B812-0A		MicroSmart user manual
FC9Y-B1138-0		MicroSmart Pentra user manual
SW1A-W1C		Automation Organizer Software Suite

RV8 Series 6mm Interface Relays

Key Features

- Space-saving 6mm width
- Only 70mm in height from DIN rail
- Gold-plated contacts
- Pre-assembled relay and DIN mount socket
- Universal screw terminals (flat and Phillips)
- Universal AC/DC socket with built-in surge suppression and green LED
- Lever for easy locking and removal of relay
- Wide input voltage range: 6 to 240V
- High dielectric strength and impulse withstand voltages
- Sensitive coil 170mW
- Reverse Polarity protected
- 400V AC maximum switching voltage
- 1500VA maximum switching power
- RoHS compliant

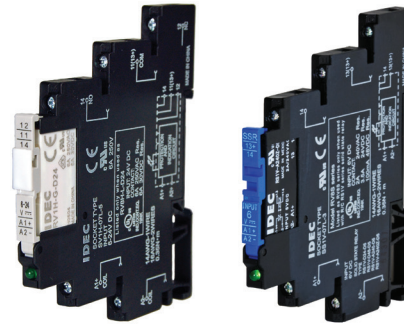

Part Numbers

Coil Voltage	Screw Terminal	Spring Clamp
DC	6V	RV8H-L-D6 RV8H-S-D6
	9V	RV8H-L-D9 RV8H-S-D9
	12V	RV8H-L-D12 RV8H-S-D12
	18V	RV8H-L-D18 RV8H-S-D18
	24V	RV8H-L-D24 RV8H-S-D24
AC/DC	12V	RV8H-L-AD12 RV8H-S-AD12
	18V	RV8H-L-AD18 RV8H-S-AD18
	24V	RV8H-L-AD24 RV8H-S-AD24
	48V	RV8H-L-AD48 RV8H-S-AD48
	60V	RV8H-L-AD60 RV8H-S-AD60
	110V - 125V	RV8H-L-AD110 RV8H-S-AD110
220V - 240V	RV8H-L-AD220 RV8H-S-AD220	

Standard stock models in bold.

Accessories



Item	Color	Part Number
Jumper (20 combs) ¹	Black	SV9Z-J20B
	Gray	SV9Z-J20W
	Blue	SV9Z-J20S
Spacer (circuit separator) ²	-	SV9Z-SA2W
Marking plate (10 pcs)	-	SV9Z-PW10



1. Jumper combs come with 20 points, if shorter lengths are needed simply cut off the excess points.
 2. Width of spacer: 2mm
- Note: When using a cut jumper, please use a spacer on the cut side. For additional information see instruction sheet.

Starter Kits and Solution Packages

MicroSmart Starter Kits

Item	Part Numbers	Controller	Power Supply	Software (Prog. Cables Included)
	MM-SMART-10	10 I/O FC4A-C10R2 CPU	–	Automation Organizer Software Suite
	MM-SMART-16	16 I/O FC4A-C16R2 CPU	–	
	MM-SMART-20	20 I/O FC4A-D20RK1 CPU	15W	
	MM-SMART-24	24 I/O FC4A-C24R2 CPU	–	
	MM-SMART-40	40 I/O FC4A-D40K3 Slim CPU	15W	
	MM-PENTRA-16	16 I/Os FC5A-D16RS1 CPU	30W	
	MM-PENTRA-24	24 I/Os FC5A-C24R2 CPU	–	
	MM-PENTRA-12	12 I/Os FC5A-D12S1E Embedded Ethernet	30W	

MicroSmart Solution Packages



KIT-PENTRA-12-HG3G-AHP shown

Part Numbers	Operator Interface	Controller	Power Supply	Software (Prog. Cables Included)
KIT-PENTRA-24-HG1F	4.6" HG1F Mono	24 I/O FC5A-C24R2C CPU	60W	Automation Organizer Software Suite
KIT-PENTRA-12-HG1F	4.6" HG1F Mono	12 I/O FC5A-D12S1E Embedded Ethernet CPU	60W	
KIT-PENTRA-24-HG2G-M	5.7" HG2G Color TFT LCD	24 I/O FC5A-C24R2C CPU	60W	
KIT-PENTRA-12-HG2G-M	5.7" HG2G Color TFT LCD	12 I/O FC5A-D12S1E Embedded Ethernet CPU	60W	
KIT-PENTRA-24-HG2G-TE	5.7" HG2G Color TFT LCD	24 I/O FC5A-C24R2C CPU	60W	
KIT-PENTRA-12-HG2G-TE	5.7" HG2G Color TFT LCD	12 I/O FC5A-D12S1E Embedded Ethernet CPU	60W	
KIT-PENTRA-24-HG2G-HP	5.7" HG2G Color TFT LCD	24 I/O FC5A-C24R2C CPU	60W	
KIT-PENTRA-16-HG2G-HP	5.7" HG2G Color TFT LCD	16 I/O FC5A-D16RS1 CPU	60W	
KIT-PENTRA-12-HG2G-HP	5.7" HG2G Color TFT LCD	12 I/O FC5A-D12S1E Embedded Ethernet CPU	60W	
KIT-PENTRA-16-HG3G-8HP	8.4" HG3G Color TFT LCD	16 I/O FC5A-D16RS1 CPU	60W	
KIT-PENTRA-12-HG3G-8HP	8.4" HG3G Color TFT LCD	12 I/O FC5A-D12S1E Embedded Ethernet CPU	60W	
KIT-PENTRA-16-HG3G-AHP	10.4" HG3G Color TFT LCD	16 I/O FC5A-D16RS1 CPU	60W	
KIT-PENTRA-12-HG3G-AHP	10.4" HG3G Color TFT LCD	12 I/O FC5A-D12S1E Embedded Ethernet CPU	60W	
KIT-PENTRA-16-HG4G-HP	12.1" HG4G Color TFT LCD	16 I/O FC5A-D16RS1 CPU	60W	
KIT-PENTRA-12-HG4G-HP	12.1" HG4G Color TFT LCD	12 I/O FC5A-D12S1E Embedded Ethernet CPU	60W	



OI Touchscreens have black bezels. All packages come with Automation Organizer software suite and communication cables.

Automation Organizer Suite Programming Software

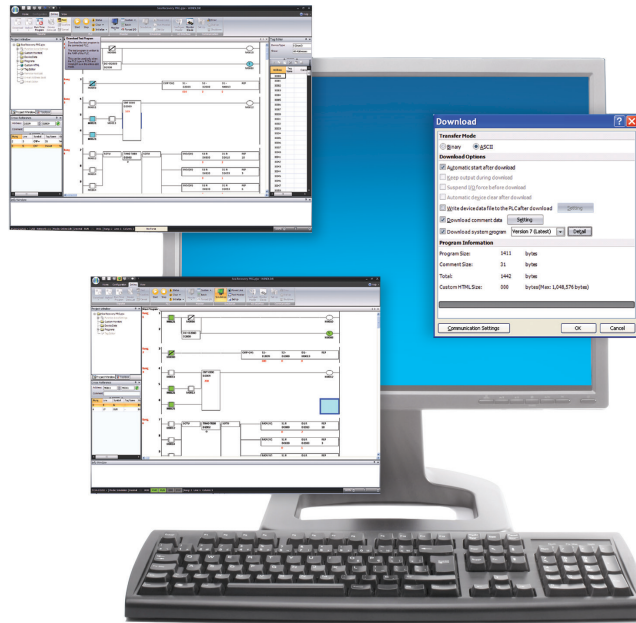

Automation Organizer (AO) is a powerful software suite containing PLC programming software (WindLDR), OI touchscreen configuration software (WindO/I-NV2/NV3) and system configuration software (WindCFG). AO boasts a completely new graphic user interface and redesigned menu icons. AO is a one-stop automation software package for IDEC MicroSmart Pentra PLCs and IDEC OI touchscreens, and is compatible with Windows XP, Vista (32 bit) and Windows 7 and 8 (32 and 64-bit).

Automation Organizer **WindLDR**

All IDEC MicroSmart Pentra PLCs are programmable with WindLDR ladder logic software. This icon-driven programming tool combines logic and intuition with an incredibly easy-to-use interface to allow you to take advantage of MicroSmart features. Even without ladder program experience, you can use the built-in editors, shortcuts and debuggers to configure programs. WindLDR is an excellent, long-term investment for your control solutions.

Simulation Mode

WindLDR allows you to simulate ladder programs with built-in Simulation mode. You can easily test and verify functionality of your ladder program without actual hardware.

Online Editing

Shutting down your PLC for minor changes can be a major hassle, so WindLDR allows you to edit and download programs without interrupting PLC operation. You can write new values to counters, timers and registers at any time without switching between editor mode (for programming) and monitor mode.

Firmware Download

With WindLDR version 6.4 or later, you have the option to upgrade or downgrade your CPU system program. It's as simple as clicking on the checkbox in the Download dialog box. Now you can easily update your PLC system firmware with the click of a button.

FREE Upgrades

The Automation Organizer suite comes with free lifetime upgrades. Once you make the initial purchase, upgrades are absolutely free.

Automation Organizer **WindO/I-NV2**

Automation Organizer **WindO/I-NV3**

Automation Organizer **WindO/I-NV4**

WindO/I-NV2/NV3/NV4 software is the programming tool available for all IDEC OI touchscreens and FT1A Touch. It is used to create projects or programs that can display information from a PLC, process status, or can be used to input data with virtual switches or keypads to make changes to a process. The objects are extremely easy to configure with the help of step-by-step navigation. It lets you quickly create colorful graphical screens in no time using drop-down menus and intuitive drag and drop functionality for the objects. A workspace is available to help you organize and manage projects, objects and screens.

Automation Organizer **WindCFG**

WindCFG is a system layout and configuration tool for IDEC PLCs and OI touchscreens. Using WindCFG, you can create a visual layout of the system design and basic configuration of your PLC and OI touchscreens.

Part Number

Part Number	Description
SW1A-W1C	Automation Organizer software suite

For more information, see page 147.

Specifications

Slim Type

Model	FC5A-D12K1E-DS0838 FC5A-D12S1E-DS0838	FC5A-D12K1E FC5A-D12S1E	FC5A-D16RK1 FC5A-D16RS1	FC5A-D32K3 FC5A-D32S3	FC4A-D20K3 FC4A-D20S3	FC4A-D20RK1 FC4A-D20RS1	FC4A-D40K3 FC4A-D40S3
Rated Power Voltage	24V DC						
Allowable Voltage Range	20.4 to 26.4V DC (including ripple)						
Maximum Input Current	700 mA (26.4V DC) ¹			560 mA (26.4V DC) ¹		700 mA (26.4V DC) ¹	
Maximum Power Consumption	19W (26.4V DC) ¹			14W (26.4V DC) ¹		17W (26.4V DC) ¹	
Allowable Momentary Power Interruption	10 ms (at 24V DC)						
Dielectric Strength	Between power and ⚡ terminals: 500V AC, 1 minute Between I/O and ⚡ terminals: 500V AC, 1 minute						
Insulation Resistance	Between power and ⚡ terminals: 10 MΩ minimum (500V DC megger) Between I/O and ⚡ terminals: 10 MΩ minimum (500V DC megger)						
Noise Resistance	DC power terminals: 1.0 kV, 50 ns to 1 μs I/O terminals (coupling clamp): 1.5 kV, 50 ns to 1 μs						
Inrush Current	50A maximum (24V DC)						
Power Supply Wire	UL1015, AWG22, UL1007 AWG18						
Operating Temperature	0 to 55°C						
Storage Temperature	-25 to +70°C (no freezing)						
Relative Humidity	Level RH1 (IEC61131-2), 10 to 95% (no condensation)						
Altitude	Operation: 0 to 2,000m, Transport: 0 to 3,000m						
Pollution Degree	2 (IEC60664-1)						
Corrosion Immunity	Free from corrosive gases						
Degree of Protection	IP20 (IEC60529)						
Grounding Wire	UL1015, AWG22, UL1007, AWG18						
Vibration Resistance	When mounted on a DIN rail or panel surface: 5 to 8.4 Hz amplitude 3.5 mm, 8.4 to 150 Hz acceleration 9.8 m/s ² (1G), 2 hours per axis on each of three mutually perpendicular axes (IEC61131-2)						
Shock Resistance	147 m/s ² (15G), 11 ms duration, 3 shocks per axis on three mutually perpendicular axes (IEC61131-2)						
Weight	200g	230g	190g	140g	140g	185g	180g



1. CPU module + 7 I/O modules

OI Touchscreens

PLCs

Automation Software

Power Supplies

Sensors

Communication

Barriers

All-in-One Type

Model	FC5A-C10R2 FC5A-C10R2C FC5A-C10R2D	FC5A-C16R2 FC5A-C16R2C FC5A-C16R2D	FC5A-C24R2 FC5A-C24R2C FC5A-C24R2D	FC4A-C10R2 FC4A-C10R2C	FC4A-C16R2 FC4A-C16R2C	FC4A-C24R2 FC4A-C24R2C
Rated Power Voltage	AC power type: 100 to 240V AC, DC power type: 24V DC, 12V DC					
Allowable Voltage Range	AC power type: 85 to 264V AC, 24V DC power type: 20.4 to 28.8V DC (including ripple), 12V DC type: 10.2 to 18.0V DC					
Rated Power Frequency	AC power type: 50/60 Hz (47 to 63 Hz)					
Maximum Input Current	250 mA (85V AC) 160 mA (24V DC)	300 mA (85V AC) 190 mA (24V DC)	450 mA (85V AC) ¹ 360 mA (24V DC) ²	250 mA (85V AC) 160 mA (24V DC)	300 mA (85V AC) 190 mA (24V DC)	450 mA (85V AC) ¹ 360 mA (24V DC) ²
Maximum Power Consumption	AC Power FC5A-C10R2/FC4A-C10R2: 30VA (264V AC), 20VA (100V AC) ³ FC5A-C16R2/FC4A-C16R2: 31VA (264V AC), 22VA (100V AC) ³ FC5A-C24R2/FC4A-C24R2: 40VA (264V AC), 33VA (100V AC) ¹					
	DC Power FC5A-C10R2C/FC4A-C10R2C: 3.9W (24V DC) *5 FC5A-C10R2D: 2.8W (12V DC) ⁴ FC5A-C16R2C/FC4A-C16R2C: 4.6W (24V DC) *5 FC5A-C16R2D: 3.4W (12V DC) ⁴ FC5A-C24R2C/FC4A-C24R2C: 8.7W (24V DC) *3 FC5A-C24R2D: 4.2W (12V DC) ⁴					
Allowable Momentary Power Interruption	10 ms (rated power voltage)					
Dielectric Strength	Between power and ⊕ or ⊖ terminals: 1,500V AC, 1 minute Between I/O and ⊕ or ⊖ terminals: 1,500V AC, 1 minute					
Insulation Resistance	Between power and ⊕ or ⊖ terminals: 10 MΩ minimum (500V DC megger) Between I/O and ⊕ or ⊖ terminals: 10 MΩ minimum (500V DC megger)					
Noise Resistance	AC power terminals: 1.5 kV, 50 ns to 1 μs DC power terminals: 1.0 kV, 50 ns to 1 μs I/O terminals (coupling clamp): 1.5 kV, 50 ns to 1 μs					
Inrush Current	FC5A-C10R2/FC5A-C10R2C/FC5A-C16R2/ FC5A-C16R2C: 35A FC5A-C10R2D/FC5A-C16R2D: 20A		FC5A-C24R2/ FC5A-C24R2C: 40A FC5A-C24R2D: 20A	35A		40A
Power Supply Wire	UL1015 AWG22, UL1007 AWG18					
Operating Temperature	0 to 55°C					
Storage Temperature	-25 to +70°C (no freezing)					
Relative Humidity	Level RH1 (IEC61131-2), 10 to 95% (no condensation)					
Altitude	Operation: 0 to 2,000m, Transport: 0 to 3,000m					
Pollution Degree	2 (IEC60664-1)					
Corrosion Immunity	Free from corrosive gases					
Degree of Protection	IP20 (IEC60529)					
Ground	Ground resistance 100Ω (max.)					
Grounding Wire	UL1007, AWG16					
Vibration Resistance	When mounted on a DIN rail or panel surface: 5 to 8.4 Hz amplitude 3.5 mm, 8.4 to 150 Hz acceleration 9.8 m/s ² (1G), 2 hours per axis on each of three mutually perpendicular axes (IEC61131-2)					
Shock Resistance	147 m/s ² (15G), 11 ms duration, 3 shocks per axis on three mutually perpendicular axes (IEC61131-2)					
Weight	AC type: 230g DC type: 240g	AC type: 250g DC type: 260g	AC type: 305g DC type: 310g	AC type: 230g DC type: 240g	AC type: 250g DC type: 260g	AC type: 305g DC type: 310g



1. CPU module (including 250 mA sensor power) + 4 I/O modules
2. CPU module + 4 I/O modules
3. CPU module (including 250 mA sensor power)
4. CPU module

Slim Type Function Specifications

Model	FC5A-D12K1E-DS0838 FC5A-D12S1E-DS0838	FC5A-D12K1E FC5A-D12S1E	FC5A-D16RK1 FC5A-D16RS1	FC5A-D32K3 FC5A-D32S3	FC4A-D20K3 FC4A-D20S3	FC4A-D20RK1 FC4A-D20RS1	FC4A-D40K3 FC4A-D40S3
Control System	Stored program system						
Instruction Words	42 basic			35 basic			
Program Capacity ¹	127.8 KB (21,300 steps)			62.4 KB (10,400 steps)		27 KB (4,500 steps) 31.2 KB (5,200 steps) ²	
User Program Storage	Flash ROM (10,000 times rewritable)			EEPROM (10,000 times rewritable)			
Processing Time	Basic Instruction END Processing ³			83 μs (1,000 steps) 0.35 ms		1.65 ms (1,000 steps) 0.64 ms	
Expandable I/O Modules	7 modules + additional 8 modules using the expansion interface module				7 modules		
I/O Points	Input	8	Expansion: 224 Additional: 256	8	Expansion: 224 Additional: 256	16	Expansion: 224 Additional: 256
I/O Points	Output	4	Expansion: 224 Additional: 256	4	Expansion: 224 Additional: 256	8	Expansion: 224 Additional: 256
Internal Relay	2,048 points				1,024 points		
Shift Register	256 points				128 points		
Data Register	42,000 points			42,000 points ⁴		1,300 points	
Expansion Data Register	6,000 points			—		6,000 points	
Counter	256 points			100 points			
Timer (1-sec, 100-ms, 10-ms, 1-ms)	256 points			100 points			
RAM Backup	Backup Data	Internal relay, shift register, counter, data register, expansion data register					
	Backup Method	Non-volatile memory (MRAM)			Battery		
	Backup Retention	Approx. 10 yrs without Backup Cycle			Approx. 30 days (typical) at 25°C after backup battery fully charged		
	Battery	Lithium secondary battery					
	Charging Time	Approx. 15 hours for charging from 0% to 90% of full charge					
	Battery Life	5 years in cycles of 9-hour charging and 15-hour discharging					
	Replaceability	Not possible to replace battery					
Self-diagnostic Function	Power failure, watchdog timer, data link connection, user program ROM sum check, timer/counter preset value sum check, user program RAM sum check, keep data, user program syntax, user program writing, CPU module, clock IC, I/O bus initialize, user program execution						
Input Filter	Without filter, 3 to 15 ms (selectable in increments of 1 ms)						
Catch Input/Interrupt Input	Four inputs (I2 and I5) Minimum turn on pulse width: 40 μs maximum Minimum turn off pulse width: 150 μs maximum (I3 and I4) Minimum turn on pulse width: 5 μs maximum Minimum turn off pulse width: 5 μs maximum				Four inputs (I2 through I5) Minimum turn on pulse width: 40 μs maximum Minimum turn off pulse width: 150 μs maximum		
High-speed Counter	Maximum Counting Frequency and High-speed Counter Points	Total 4 points Single/two-phase selectable: 100 kHz (2 points) Single-phase: 100 kHz (2 points)				Total 4 points Single/two-phase selectable: 20 kHz (2 points) Single-phase: 5 kHz (2 points)	
	Counting Range	0 to 4,294,967,295 (32 bits)				0 to 65,535 (16 bits)	
	Operation Mode	Rotary encoder mode and adding counter mode					
Analog Potentiometer	Quantity	1 point					
	Data Range	0 to 255					
Analog Voltage Input	Quantity	1 point					
	Input Voltage Range	0 to 10V DC					
	Input Impedance	Approx. 100 kΩ					
	Data Range	0 to 255 (8 bits)					
Pulse Output	Quantity	3 points		2 points	3 points	2 points	
	Maximum Frequency	100 kHz				20 kHz	

- Note: The maximum number of relay outputs that can be turned on simultaneously is 54 including those on the CPU module. Modem communication not possible on FC5A-D12K1E/D12S1E modules.
- 1 step equals 6 bytes.
 - Expandable up to 62.4 KB when a memory cartridge is used.
 - Not including expansion I/O service time, clock function processing time, data link processing time, and interrupt processing time.
 - Extra data registers D10000 through D49999 are enabled using WindLDR Function Area Settings, then run-time program download cannot be used.
 - Maintenance communication (change monitor device values, upload/download user programs, download system program)
 - Maintenance communication, user communication, modem communication, data link, Modbus ASCII/RTU master/slave communication (FC5A only).

01 Touchscreens

PLCs

Automation Software

Power Supplies

Sensors

Communication

Barriers

Slim Type Function Specifications (con't)

Model		FC5A-D12K1E-DS0838 FC5A-D12S1E-DS0838	FC5A-D12K1E FC5A-D12S1E	FC5A-D16RK1 FC5A-D16RS1	FC5A-D32K3 FC5A-D32S3	FC4A-D20K3 FC4A-D20S3	FC4A-D20RK1 FC4A-D20RS1	FC4A-D40K3 FC4A-D40S3
Ethernet Port	Ethernet Specifications	Electrical Characteristics: Complies with IEEE802.3 Transmission Speed: 10BASE-T/100BASE-TX						
	Ethernet Interface	RJ45						
	User Web Page Area	1 MB						
	Compliant Browser	Internet Explorer 7 and 8, Firefox 3				—		
	Protocol	Data Link Layer: IP, ARP Network Layer: UDP, TCP, ICMP Application Layer: SMTP, DHCP, HTTP, NBNS, DNS, SNTP						
Function (see table next page)	Web server, Send email, PING, Maintenance communication server, Modbus TCP server/client, User communication server/client, SNTP							
Port 1	USB mini-B (CDC class) Maintenance Communication ⁵			RS232C – maintenance communication, user communications, Modbus slave ASCII/RTU communication (FC5A only)				
Port 2 Communication Adapter/Module (option) ⁶				Possible				
Clock Cartridge (option)				Possible				
Memory Cartridge (option)				Possible				
HMI Module (option)				Possible				

-  Note: The maximum number of relay outputs that can be turned on simultaneously is 54 including those on the CPU module. Modem communication not possible on FC5A-D12K1E/D12S1E modules.
1. 1 step equals 6 bytes.
 2. Expandable up to 62.4 KB when a memory cartridge is used.
 3. Not including expansion I/O service time, clock function processing time, data link processing time, and interrupt processing time.
 4. Extra data registers D10000 through D49999 are enabled using WindLDR Function Area Settings, then run-time program download cannot be used.
 5. Maintenance communication (change monitor device values, upload/download user programs, download system program)
 6. Maintenance communication, user communication, modem communication, data link, Modbus ASCII/RTU master/slave communication (FC5A only).

I/O Touchscreens

PLCs

Automation Software

Power Supplies

Sensors

Communication

Barriers

All-in-One Type Function Specifications

Model	FC5A-C10R2 FC5A-C10R2C FC5A-C10R2D	FC5A-C16R2 FC5A-C16R2C FC5A-C16R2D	FC5A-C24R2 FC5A-C24R2C FC5A-C24R2D	FC4A-C10R2 FC4A-C10R2C	FC4A-C16R2 FC4A-C16R2C	FC4A-C24R2 FC4A-C24R2C		
Control System	Stored program system							
Instruction Words	42 basic			35 basic				
	103 advanced	103 advanced	115 advanced	38 advanced	40 advanced	48 advanced		
Program Capacity ¹	13.8 KB (2,300 steps)	27 KB (4,500 steps)	54 KB (9,000 steps)	4.8 KB (800 steps)	15 KB (2,500 steps)	27 KB (4,500 steps)		
User Program Storage	EEPROM (10,000 times rewritable)							
Processing Time	Basic Instruction	1.16 ms (1,000 steps)			1.65 ms (1,000 steps)			
	END Processing ²	0.64 ms			0.64 ms			
Expandable I/O Module	—		4 modules	—		4 modules		
I/O Points	Input	6	9	14	Expansion: 6	9	14	Expansion: 64
	Output	4	7	10	64 ³	4	7	
Internal Relay	2,048 points			256 points	1,024 points			
Shift Register	128 points			64 points	128 points			
Data Register	2,000 points			400 points	1,300 points			
Expansion Data Register	—							
Counter	256 points			32 points	100 points			
Timer (1-sec, 100-ms, 10-ms, 1-ms)	256 points			32 points	100 points			
RAM Backup	Backup Data	Internal relay, shift register, counter, data register						
	Backup Duration	Approx. 30 days (typical) at 25°C after backup battery fully charged						
	Battery	Lithium secondary battery						
	Charging Time	Approx. 15 hours for charging from 0% to 90% of full charge						
	Battery Life	5 years in cycles of 9-hours charging and 15-hours discharging						
	Replaceability	Not possible to replace battery						
Self-diagnostic Function	Power failure, watchdog timer, data link connection, user program EEPROM sum check, timer/counter preset value sum check, user program RAM sum check, keep data, user program syntax, user program writing, CPU module, clock IC, I/O bus initialize, user program execution							
Input Filter	Without filter, 3 to 15 ms (selectable in increments of 1 ms)							
Catch Input/Interrupt Input	Four inputs (I2 through I5) Minimum turn on pulse width: 40 μs maximum Minimum turn off pulse width: 150 μs maximum							
High-speed Counter	Maximum Counting Frequency and High-speed Counter Points	Total 4 points Single/two-phase selectable: 50 kHz (1 point) Single-phase: 5 kHz (3 points)			Total 4 points Single/two-phase selectable: 20 kHz (1 point) Single-phase: 5 kHz (3 points)			
	Counting Range	0 to 65,535 (16 bits)						
	Operation Mode	Rotary encoder mode and adding counter mode						
	Quantity	1 point		2 points	1 point		2 points	
Analog Potentiometer	Quantity	1 point		2 points	1 point		2 points	
	Data Range	0 to 255						
	Quantity	—						
Analog Voltage Input	Quantity	—						
	Input Voltage Range	—						
	Input Impedance	—						
Pulse Output	Quantity	—						
	Max. Frequency	—						
Sensor Power Supply (AC Power Type Only)	Output Voltage/Current	24V DC (+10% to -15%), 250 mA						
	Overload Detection	Not available						
	Isolation	Isolated from the internal circuit						
Port 1	RS232C – maintenance communication, user communications, Modbus ASCII/RTU slave communication (FC5A only)							
Port 2 Communication Adapter (option) ⁴	Possible	Possible	Possible	—	Possible	Possible		
Clock Cartridge (option)	Possible	Possible	Possible	Possible	Possible	Possible		
Memory Cartridge (option)	Possible	Possible	Possible	Possible	Possible	Possible		
HMI Module (option)	Possible	Possible	Possible	Possible	Possible	Possible		



1. 1 step equals 6 bytes.
 2. Not including expansion I/O service time, clock function processing time, data link processing time, and interrupt processing time.
 3. Expansion modules cannot be connected to FC5A-C24R2D.
 4. Maintenance communication, user communication, Modem communication, data link, Modbus ASCII/RTU master/slave communication (FC5A only).
- Note: The maximum number of relay outputs that can be turned on simultaneously is 33 including those on the CPU module.

OI Touchscreens

PLCs

Automation Software

Power Supplies

Sensors

Communication

Barriers

Communication Port (Port 1) Specifications

CPU Module	FC5A-D12K1E/D12S1E	Slim CPU	All-in-One CPU
Standards	USB 2.0	EIA RS232C	
Maximum Baud Rate	USB 2.0	FC5A: 57,600 bps (maintenance communication) FC4A: 19,200 bps (maintenance communication)	
Cable	HG9Z-XCM2A	FC2A-KC4C, FC2A-KP1C, FC4A-KC1C, FC4A-KC2C	
Isolation between Internal Circuit and Communication Port	Not isolated	Not isolated	

Slim Type Input Specifications

Model	FC5A-D12K1E-DS0838 FC5A-D12S1E-DS0838	FC5A-D12K1E FC5A-D12S1E	FC4A-D20K3 FC4A-D20S3	FC5A-D16RK1 FC5A-D16RS1	FC4A-D20RK1 FC4A-D20RS1	FC5A-D32K3 FC5A-D32S3	FC4A-D40K3 FC4A-D40S3
Input Points	8 (8/1 common)	8 (8/1 common)	12 (12/1 common)	8 (8/1 common)	12 (12/1 common)	16 (8/1 common)	24 (12/1 common)
Rated Input Voltage	24V DC sink/source input signal						
Input Voltage Range	20.4 to 26.4V DC						
Rated Input Current		FC5A	I0, I1, I3, I4, I6, I7: I2, I5, I10 to I17:	4.5 mA/point (24V DC) 7 mA/point (24V DC)			
		FC4A	I0, I1, I6, I7: I2 to I5, I10 to I27:	5 mA/point (24V DC) 7 mA/point (24V DC)			
Input Impedance		FC5A	I0, I1, I3, I4, I6, I7: I2, I5, I10 to I17:	4.9 kΩ 3.4 kΩ			
		FC4A	I0, I1, I6, I7: I2 to I5, I10 to I27:	5.7 kΩ 3.4 kΩ			
Turn ON Time		FC5A	I0, I1, I3, I4, I6, I7: I2 and I5: I10 to I17:	5 μs + filter value 35 μs + filter value 40 μs + filter value			
		FC4A	I0, I1, I6, I7: I2 to I5: I10 to I27:	35 μs + filter value 35 μs + filter value 40 μs + filter value			
Turn OFF Time		FC5A	I0, I1, I3, I4, I6, I7: I2 and I5: I10 to I17:	5 μs + filter value 150 μs + filter value 150 μs + filter value			
		FC4A	I0, I1, I6, I7: I2 to I5: I10 to I27:	45 μs + filter value 150 μs + filter value 150 μs + filter value			
Connector	On Mother Board	MC1.5/16-G-3.81BK (Phoenix Contact)		FL26A2MA (Oki Electric Cable)	MC1.5/13-G-3.81BK (Phoenix Contact)		FL26A2MA (Oki Electric Cable)
	Insertion Durability	100 times minimum					
Isolation	Between input terminals: Optocoupler isolated Internal circuit: Not isolated						
Input Type	Type 1 (IEC61131-2)						
External Load for I/O Interconnection	Not needed						
Single Determination Method	Static						
Effect of Improper Input Connection	Both sinking and sourcing input signals can be connected, therefore reverse connection does not cause permanent damage. If any input exceeding the rated value is applied, permanent damage may be caused.						
Cable Length	3m in compliance with electromagnetic immunity						

All-in-One Type Input Specifications

Model	FC5A-C10R2 FC5A-C10R2C	FC5A-C16R2 FC5A-C16R2C	FC5A-C24R2 FC5A-C24R2C	FC5A-C10R2D	FC5A-C16R2D	FC5A-C24R2D
	FC4A-C10R2 FC4A-C10R2C	FC4A-C16R2 FC4A-C16R2C	FC4A-C24R2 FC4A-C24R2C	—	—	—
Input Points	6 (6/1 common)	9 (9/1 common)	14 (14/1 common)	6 (6/1 common)	9 (9/1 common)	14 (14/1 common)
Rated Input Voltage	24V DC sink/source input signal			12V DC sink/source input signal		
Input Voltage Range	20.4 to 28.8V DC			10.2 to 18.0V DC		
Rated Input Current	FC5A I0 and I1: I2 to I7, I10 to I15:	I0 and I1: I2 to I7, I10 to I15:	6.4 mA/point 7 mA/point (24V DC) 11 mA 7 mA/point (24V DC)	I0 and I1: I2 to I7, I10 to I15:	6 mA 6 mA	
Input Impedance	FC5A I0 and I1: I2 to I7, I10 to I15:	I0 and I1: I2 to I7, I10 to I15:	3.7 kΩ 3.4 kΩ	I0 and I1: I2 to I7, I10 to I15:	1.8 kΩ 2.0 kΩ	
Turn ON Time	FC5A I0 and I1: I2 to I5: I6, I7, I10 to I15:	I0 and I1: I2 to I5: I6, I7, I10 to I15:	2 μs + filter value 35 μs + filter value 40 μs + filter value	I0 and I1: I2 to I5: I6, I7, I10 to I15:	2 μs + filter value 35 μs + filter value 40 μs + filter value	
Turn OFF Time	FC5A I0 and I1: I2 to I5: I6, I7, I10 to I15:	I0 and I1: I2 to I5: I6, I7, I10 to I15:	16 μs + filter value 150 μs + filter value 150 μs + filter value	I0 and I1: I2 to I5: I6, I7, I10 to I15:	16 μs + filter value 150 μs + filter value 150 μs + filter value	
Isolation	Between input terminals: Optocoupler isolated Internal circuit: Not isolated					
Input Type	Type 1 (IEC61131-2)					
External Load for I/O Interconnection	Not needed					
Single Determination Method	Static			—		
Effect of Improper Input Connection	Both sinking and sourcing input signals can be connected, therefore reverse connection does not cause permanent damage. If any input exceeding the rated value is applied, permanent damage may be caused.					
Cable Length	3m in compliance with electromagnetic immunity					

OI Touchscreens

PLCs

Automation Software

Power Supplies

Sensors

Communication

Barriers

Transistor Sink and Source Output Specifications

Model	FC5A-D12K1E-DS0838 FC5A-D12S1E-DS0838	FC5A-D12K1E FC5A-D12S1E	—	FC5A-D16RK1 FC5A-D16RS1	FC5A-D32K3 FC5A-D32S3
		—	FC4A-D20RK1 FC4A-D20RS1	—	FC4A-D40K3 FC4A-D40S3
Transistor Output Points	4 (4/1 common)	4 (4/1 common)	2 (2/1 common)	2 (2/1 common)	16 (8/1 common)
Output Type	Transistor Sink	FC5A-D12K1E/D16RK1/D32K3 FC4A-D20K3/D20RK1/D40K3			
	Transistor Source	FC5A-D12S1E/D16RS1/D32S3 FC4A-D20S3/D20RS1/D40S3			
Rated Load Voltage	24V DC				
Operating Load Voltage Range	20.4 to 28.8V DC				
Rated Load Current	0.3A per output point				
Maximum Load Current	1A per common				
Voltage Drop (ON Voltage)	1V maximum (voltage between COM and output terminals when output is on)				
Inrush Current	1A				
Leakage Current	0.1 mA maximum				
Clamping Voltage	39V±1V				
Maximum Lamp Load	8W				
Inductive Load	L/R = 10 ms (28.8V DC, 1 Hz)				
External Current Draw	Sink output: 100 mA maximum, 24V DC (power voltage at the +V terminal) Source output: 100 mA maximum, 24V DC (power voltage at the -V terminal)				
Isolation	Between output terminal and Internal circuit: Photocoupler isolated Between output terminals: Not isolated				
Connector on Mother Board	MC1.5/16-G-3.81BK (Phoenix Contact)		FL26A2MA (Oki Electric Cable)	MC1.5/16-G-3.81BK (Phoenix Contact)	FL26A2MA (Oki Electric Cable)
Connector Insertion/ Removal Durability	100 times minimum				
Output Delay	Turn ON Time	FC5A	Q0 to Q2: Q3 to Q7, Q10 to Q17:	5 µs max. 300 µs max.	
		FC4A	Q0, Q1: Q2 to Q7, Q10 to Q17:	5 µs max. 300 µs max.	
	Turn OFF Time	FC5A	Q0 to Q2: Q3 to Q7, Q10 to Q17:	5 µs max. 300 µs max.	
		FC4A	Q0, Q1: Q2 to Q7, Q10 to Q17:	5 µs max. 300 µs max.	

OT Touchscreens

PLCs

Automation Software

Power Supplies

Sensors

Communication

Barriers

Relay Output Specifications

Model	FC5A-C10R2 FC5A-C10R2C FC5A-C10R2D	FC5A-C16R2 FC5A-C16R2C FC5A-C16R2D	FC5A-C24R2 FC5A-C24R2C FC5A-C24R2D	FC5A-D16RK1 FC5A-D16RS1
	FC4A-C10R2 FC4A-C10R2C	FC4A-C16R2 FC4A-C16R2C	FC4A-C24R2 FC4A-C24R2C	FC4A-D20RK1 FC4A-D20RS1
Relay Output Points	4	7	10	6
Output Points per Common Line	COM0	3	4	—
	COM1	1	2	3
	COM2	—	1	2
	COM3	—	—	1
Output Type	1NO			
Maximum Load Current	2A per point 8A per common line			
Minimum Switching Load	1 mA/ 5V DC (reference value)			
Initial Contact Resistance	30 mΩ maximum			
Electrical Life	100,000 operations minimum (rated load 1,800 operations/hour)			
Mechanical Life	20,000,000 operations minimum (no load 18,000 operations/hour)			
Rated Load	240V AC/2A (resistive load, inductive load cos φ = 0.4) 30V DC/2A (resistive load, inductive load L/R =7 ms)			
Dielectric Strength	Between output and ⚡ terminals:		1,500V AC, 1 minute	
	Between output terminal and internal circuit:		1,500V AC, 1 minute	
	Between output terminals (COMs):		1,500V AC, 1 minute	
Connector on Mother Board	—			*1
Connector Insertion/ Removal Durability	—			100 times minimum

 1. MC1.5/16-G-3.81BK (Phoenix Contact)

OI Touchscreens

PLCs

Automation Software

Power Supplies

Sensors

Communication

Barriers

Input Usage Limits Slim CPU

FC5A-D16RK1/D16RS1
FC5A-D12K1E/D12S1E

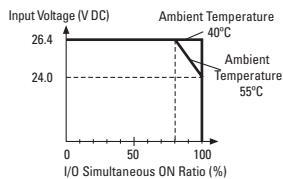

FC5A-D32K3/D32S3
FC4A-D40K3/D40S3

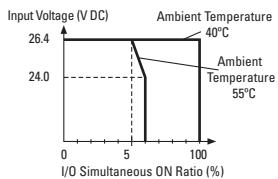

FC4A-D20K3/D20S3

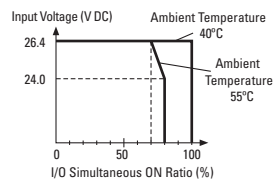

FC4A-D20RK1/D20RS1

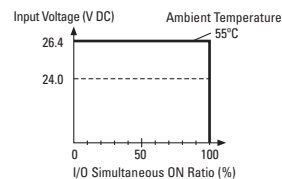

All-in-One CPU

FC5A-C10R2
FC5A-C10R2C
FC4A-C10R2
FC4A-C10R2C

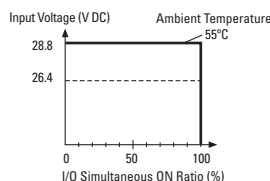

FC5A-C16R2
FC5A-C16R2C
FC4A-C16R2
FC4A-C16R2C

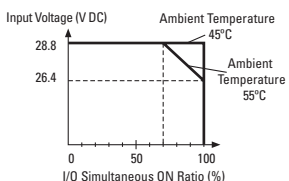

FC5A-C24R2
FC5A-C24R2C
FC4A-C24R2
FC4A-C24R2C

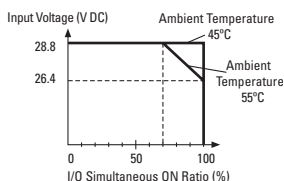

CAUTION: When using at an operating ambient temperature above 40°C, reduce the input voltage or the quantity of I/O points that turn on simultaneously.

Input Internal Circuit Slim CPU

FC5A: I0, I1, I3, I4, I6, I7
FC4A: I0, I1, I6, I7

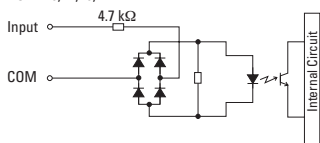

FC5A: I2, I5, I10 to I17
FC4A: I2 to I5, I10 to I27

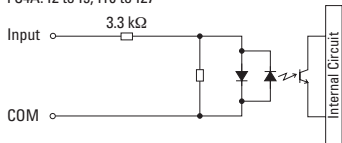

All-in-One CPU

I0, I1
3.3 kΩ (FC5A)
1.8 kΩ (FC4A)

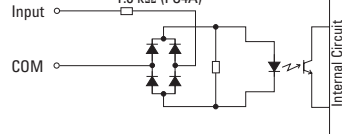

I2 to I15

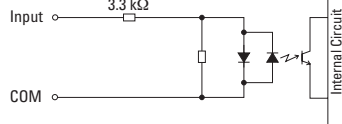

FC5A All-in-One CPU 12V DC Type

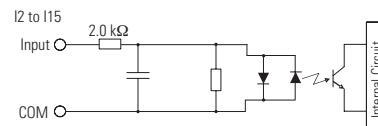
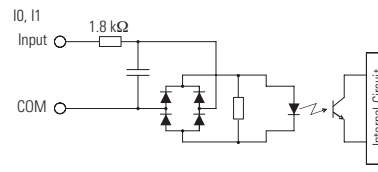

Output Internal Circuit

Slim CPU

Sink Output

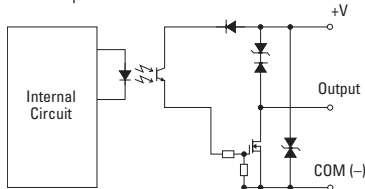

Source Output

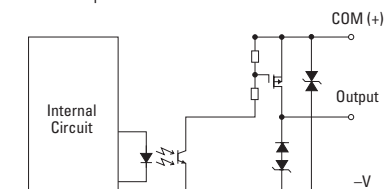

01 Touchscreens

PLCs

Automation Software

Power Supplies

Sensors

Communication

Barriers

Communication Adapter/Module Specifications

Model	FC4A-PC1 FC4A-HPC1	FC4A-PC2 FC4A-HPC2	FC4A-PC3 FC4A-HPC3
Standards	EIA RS232C	EIA RS485	EIA RS485
Maximum Baud Rate	FC5A: 57,600 bps ¹ FC4A: 19,200 bps	FC5A: 57,600 bps ¹ FC4A: 19,200 bps	FC5A: 57,600 bps ¹ FC4A: 19,200 bps (38,400 bps ²)
Maintenance Communication	Possible	Possible	Possible
User Communication	Possible	Possible ³	Possible ³
Data Link Communication	—	Possible	Possible
Half-duplex Communication	—	Possible	Possible
Maximum Cable Length	Special cable ⁴	Special cable ⁵	200m
Quantity of Slave Stations	—	31	31
Isolation between Internal Circuit and Communication Port	Not isolated		
RS485 Cable	—		Cable
			Conductor Resistance
			Shield Resistance

- 1. Maximum speed is 115,200 bps for FC5A-D12*1E.
- 2. Maximum speed when data link is used.
- 3. FC5A (all types), FC4A-D20RK1, FC4A-D20RS1, FC4A-D40K3, FC4A-D40S3
- 4. FC2A-KC4C, FC2A-KM1C, FC4A-KC1C, FC4A-KC2C, FC2A-KP1C
- 5. FC2A-KP1C

HMI Module Specifications

Model	FC4A-PH1
Power Voltage	5V DC (supplied from the CPU module)
Weight	20g

Memory Cartridge Specifications

Model	FC4A-PM32	FC4A-PM64 ⁶	FC4A-PM128 ⁶
Memory Type	EEPROM		
Accessible Memory Capacity	32 KB	64 KB	128 KB
Hardware for Storing Data	CPU Module		
Software for Storing Data	WindLDR		
Quantity of Stored Programs	One user program can be stored on one memory cartridge		

 6. Even when using a large-capacity memory cartridge, the program capacity of the CPU module takes effect, except when using FC4A-D20RK1, FC4A-D20RS1, FC4A-D40K3, and FC4A-D40S3 CPU modules, the program capacity expands to 64KB.

Clock Cartridge Specifications

Model	FC4A-PT1
Accuracy	±30 sec/month (typical) at 25°C
Backup Duration	Approx. 30 days (typical) at 25°C after backup battery fully charged
Battery	Lithium secondary battery
Charging Time	Approx. 10 hours for charging from 0% to 90% of full charge
Replaceability	Not possible to replace battery

**Expansion Serial Communication Module
General Specifications
(Expansion RS232C Communication Module)**

Model	FC5A-SIF2
No. of Port	1
Synchronization	Synchronization Start-stop synchronization
Electrical Characteristics	Electrical Characteristics EIA RS232C compliant
Maximum Delay in One Scan	Approx. 4 ms
Operating Temperature	0 to 55°C
Relative Humidity	10 to 95% (no condensation)
Recommended Cable Specifications	Shielded multi-core cable: 24AWG x 6 Dielectric strength: 2,000V AC/min Insulation resistance: 100 MΩ/km
Recommended Cable	KIDU-SB 24 AWG×6C (Nihon Electric Wire & Cable)
Connector on Mother Board	MC1.5/10-G-3.81BK (Phoenix Contact) Applicable terminal block: FC4A-PMT10P
Connector Insertion/Removal Durability	100 times minimum
Isolation from Internal Circuit	Transformer isolated
Quantity of Applicable Expansion RS232C Communication Modules	All-in-One 24-I/O type CPU module: 3 maximum ¹ Slim type CPU module: 5 maximum
Internal Current Draw	40 mA (5V/24V DC) ⁵
Weight	100g

-  Note: FC5A-SIF2 cannot be connected to FC4A CPU modules.
- FC5A All-in-One 24-I/O CPU module cannot use the FC5A-SIF2/SIF4 module in combination with the function modules listed in the table on the left. When using these modules in combination with the FC5A-SIF2/SIF4 module, use the slim type CPU module.

Function Modules	Type No.
Analog Modules	FC4A-L03A1, FC4A-L03AP1, FC4A-J2A1, FC4A-K1A1, FC4A-J4CN1, FC4A-J8C1, FC4A-J8AT1, FC4A-K2C1, FC4A-K4A1
AS-Interface Master Module	FC4A-AS62M

- 85 mA (5V DC), 0 mA (24V DC) when the communication module version is lower than V200.

(Expansion RS485 Communication Module)

Model	FC5A-SIF4
No. of Port	1
Synchronization	Synchronization Start-stop synchronization
Electrical Characteristics	Electrical Characteristics EIA RS485 compliant
Maximum Baud Rate	115,200 bps
Operating Temperature	0 to 55°C
Relative Humidity	10 to 95% (no condensation)
Recommended Cable Specifications	Shielded twisted pair cable: 22 AWG (0.3 mm2 x 2P) Conductor Resistance: 67 MΩ/km maximum (at 20°C)
Connector on Mother Board	MC1.5/10-G-3.81BK (Phoenix Contact) Applicable terminal block: FC4A-PMT10P
Connector Insertion/Removal Durability	100 times minimum
Isolation from Internal Circuit	Transformer isolated
Quantity of Applicable Expansion RS485C Communication Modules	All-in-One 24-I/O type CPU module: 3 maximum ¹ Slim type CPU module: 5 maximum
Internal Current Draw	40 mA (5V/24V DC)
Weight	100g

Note: FC5A-SIF4 cannot be connected to FC4A CPU modules.

Communication Specifications

Model	FC5A-SIF2	FC5A-SIF4
Maximum Baud Rate	1,200/2,400/4,800/9,600/19,200/38,400/57,600 ⁴ /115,200 ⁴	
Maintenance Communication	Possible ²	
Modbus Communication	Modbus ASCII master Modbus ASCII slave Modbus RTU master Modbus RTU slave	
Data Link	-	0 ³
Max Cable Length	10m	1,200m
Quantity of Slave Stations	1	31

-  2. Run-time program download is not possible.
3. Data Link can be used only on one of the communication ports.
4. Can be used when the communication module is version V200 or higher.

OT Touchscreens

PLCs

Automation Software

Power Supplies

Sensors

Communication

Barriers

Specifications (I/O Modules)

Input Module Specifications

Model	FC4A-N08B1	FC4A-N16B1	FC4A-N16B3	FC4A-N32B3	FC4A-N08A11	
Input Points	8 (8/1 common)	16 (16/1 common)		32 (16/1 common)	8 (4/1 common)	
Rated Input Voltage	24V DC sink/source input signal				100 to 120V AC (50/60 Hz)	
Input Voltage Range	20.4 to 28.8V DC				85 to 132V AC	
Rated Input Current	7 mA/point (24V DC)		5 mA/point (24V DC)		17 mA/point (120V AC, 60 Hz)	
Input Impedance	3.4 kΩ		4.4 kΩ		0.8 kΩ (60 Hz)	
ON Voltage	15V minimum				79V minimum	
OFF Voltage	5V maximum				20V maximum	
ON Current	4.2 mA minimum (at 15V DC)		3.2 mA minimum (at 15V DC)		—	
OFF Current	1.2 mA maximum		0.9 mA maximum		—	
Turn ON Time	4 ms				25 ms	
Turn OFF Time	4 ms				30 ms	
Isolation	Between input terminals: Not isolated Internal circuit: Photocoupler isolated				Between input terminals in the same common: Not isolated Between input terminals in different commons: Isolated Between input terminals and internal circuits: Photocoupler isolated	
External Load for I/O Interconnection	Not needed				Not needed	
Single Determination Method	Static				Static	
Effect of Improper Input Connection	Both sink and source input signals can be connected. If any input exceeding the rated value is applied, permanent damage may be caused.				If any input exceeding the rated value is applied, permanent damage may be caused.	
Cable Length	3m in compliance with electromagnetic immunity				—	
Connector on Mother Board	MC1.5/10-G-3.81BK (Phoenix Contact)		FL20A2MA (Oki Electric Cable)		MC1.5/11-G-3.81BK (Phoenix Contact)	
Connector Insertion/Removal Durability	100 times minimum					
Applicable Ferrule	1-wire: AI 0.5-8 WH (Phoenix Contact) 2-wire: AI-TWIN 2×0.5-8 WH (Phoenix Contact)		—		—	
Internal Current Draw	All Inputs ON	25 mA (5V DC)	40 mA (5V DC)	35 mA (5V DC)	65 mA (5V DC)	60 mA (5V DC), 0 mA (24V DC)
	All Inputs OFF	5 mA (5V DC)	5 mA (5V DC)	5 mA (5V DC)	10 mA (5V DC)	30 mA (5V DC), 0 mA (24V DC)
Internal Power Consumption (at 24V DC while all inputs ON)	0.17W	0.27W	0.24W	0.44W	—	
Weight	85g	100g	65g	100g	80g	

OI Touchscreens

PLCs

Automation Software

Power Supplies

Sensors

Communication

Barriers

Mixed I/O Module Specifications

Model		FC4A-M08BR1	FC4A-M24BR2
Input Specifications	Input Points	4 (4/1 common)	16 (16/1 common)
	Rated Input Voltage	24V DC sink/source input signal	
	Input Voltage Range	20.4 to 28.8V DC	
	Rated Input Current	7 mA/point (24V DC)	
	Input Impedance	3.4 kΩ	
	ON Voltage	15V minimum	
	OFF Voltage	5V maximum	
	ON Current	4.2 mA minimum (at 15V DC)	
	OFF Current	1.2 mA maximum	
	Turn ON Time	4 ms (24V DC)	
	Turn OFF Time	4 ms (24V DC)	
	Isolation	Between input terminals: Not isolated Internal circuit: Photocoupler isolated	
	External Load for I/O Interconnection	Not needed	
	Signal Determination Method	Static	
Output Specifications	Effect of Improper Input Connection	Both sinking and sourcing input signals can be connected. If any input exceeding the rated value is applied, permanent damage may be caused.	
	Cable Length	3m in compliance with electromagnetic immunity	
	Output Points	4 (4/1 common)	8 (4/1 common)
	Output Type	1NO	
	Maximum Load Current	2A per point 7A per common	
	Minimum Switching Load	1 mA/ 5V DC (reference value)	
	Initial Contact Resistance	30 mΩ maximum	
	Electrical Life	100,000 operations minimum (rated load 1,800 operations/hour)	
	Mechanical Life	20,000,000 operations minimum (no load 18,000 operations/hour)	
	Rated Load	240V AC/2A (resistive load, inductive load cos φ = 0.4) 30V DC/2A (resistive load, inductive load L/R = 7 ms)	
	Dielectric Strength	Between output and ⊕ or ⊖ terminals: 1,500V AC, 1 minute Between output terminal and internal circuit: 1,500V AC, 1 minute Between output terminals (COMs): 1,500V AC, 1 minute	
	Connector on Mother Board	MC1.5/11-G-3.81BK (Phoenix Contact)	Input: F6018-17P (Fujicon) Output: F6018-11P (Fujicon)
	Connector Insertion/Removal Durability	100 times minimum	Not removable
	Applicable Ferrule	1-wire: AI 0.5-8 WH (Phoenix Contact), 2-wire: AI-TWIN 2×0.5-8 WH (Phoenix Contact)	
Internal Current Draw	All I/Os ON	25 mA (5V DC), 20 mA (24V DC)	65 mA (5V DC), 45 mA (24V DC)
	All I/Os OFF	5 mA (5V DC), 0 mA (24V DC)	10 mA (5V DC), 0 mA (24V DC)
Internal Power Consumption (at 24V DC while all I/Os are ON)	0.65W	1.52W	
Weight	95g	140g	

I/O Touchscreens

PLCs

Automation Software

Power Supplies

Sensors

Communication

Barriers

Input Usage Limits

FC4A-N08B1

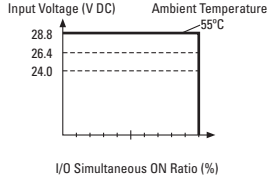

FC4A-N16B1

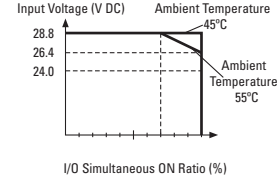

FC4A-N16B3/N32B3

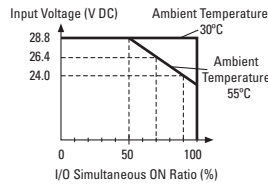

FC4A-N08A11

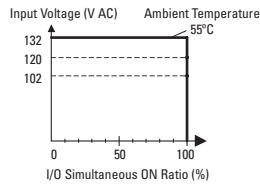

FC4A-M08BR1

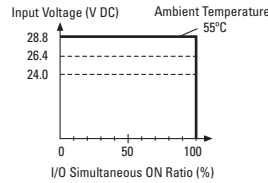

FC4A-M24BR2

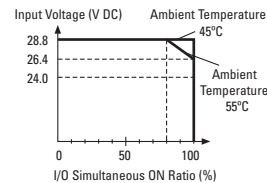

When using at an operating ambient temperature above 40°C, reduce the input voltage or the quantity of I/O points that turn on simultaneously.

Input Internal Circuit

FC4A-N08B1, FC4A-N16B1

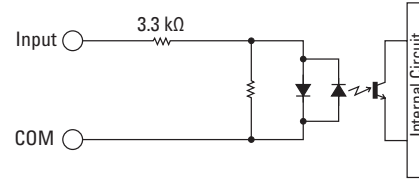

FC4A-N16B3, FC4A-N32B3

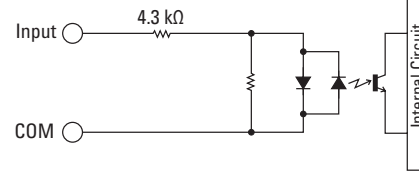

FC4A-M08BR1, FC4A-M24BR2

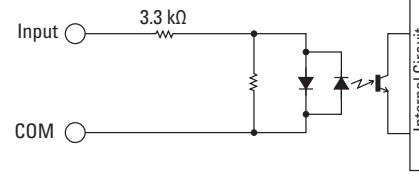

FC4A-N08A11

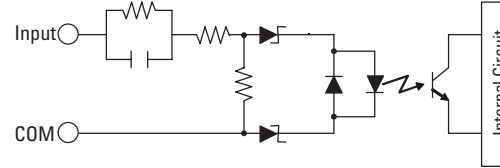

Output Internal Circuit

FC4A-T08K1, FC4A-T16K3, FC4A-T32K3

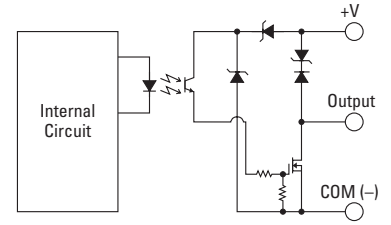

FC4A-T08S1, FC4A-T16S3, FC4A-T32S3

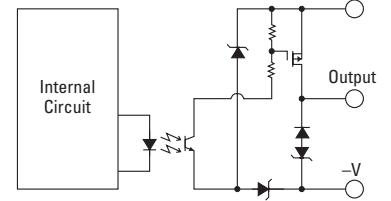

Specifications (Analog I/O Modules)

Analog I/O Module Specifications

Model	FC4A-L03A1	FC4A-L03AP1	FC4A-J2A1	FC4A-J4CN1	FC4A-J8C1	FC4A-J8AT1	FC4A-K4A1	FC4A-K1A1	FC4A-K2C1
Input Points	2	2	2	4	8	8	—	—	—
Output Points	1	1	—	—	—	—	4	1	2
Power Voltage	24V DC								
Allowable Voltage Range	20.4 to 28.8V DC								
External Current Draw * (24V DC)	45 mA	40 mA	35 mA	55 mA	50 mA	55 mA	130 mA	40 mA	85 mA
Connector on Mother Board	MC1.5/11-G-3.81BK (Phoenix Contact)			MC1.5/10-G-3.81BK (Phoenix Contact)			MC1.5/11-G-3.81BK (Phoenix Contact)		MC1.5/10-G-3.81BK (Phoenix Contact)
Connector Insertion/Removal Durability	100 times minimum								
Applicable Ferrule	1-wire: AI 0.5-8 WH (Phoenix Contact), 2-wire: AI-TWIN 2x0.5-8 WH (Phoenix Contact)								
Internal Power Consumption (5V DC)	50 mA	50 mA	50 mA	50 mA	40 mA	45 mA	65 mA	50 mA	60 mA
Internal Power Consumption (at 24V DC while all I/Os are ON)	0.34W	0.34W	0.34W	0.34W	0.27W	0.30W	0.44W	0.34W	0.40W
Weight	85g	85g	85g	140g	140g	125g	100g	85g	110g



* The external current draw is the value when all the analog inputs are used and the analog output value is at 100%.

Input Circuit

FC4A-L03A1, FC4A-L03AP1
FC4A-J2A1

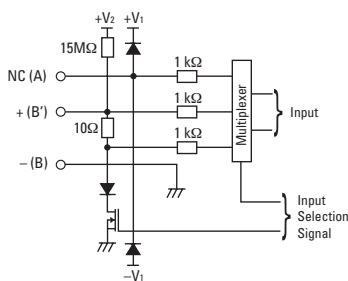

FC4A-J4CN1

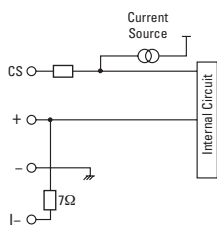

FC4A-J8C1

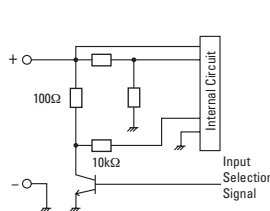

FC4A-J8AT1

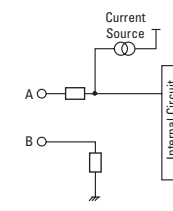

Analog Input Specifications (1)

Model		FC4A-L03A1, FC4A-J2A1		FC4A-L03AP1	
Input Signal Type		Voltage Input 0 to 10V DC	Current Input 4 to 20 mA	Resistance Thermometer Pt100 3-wire type (-100 to 500°C)	Thermocouple Type K (0 to 1,300°C) Type J (0 to 1,200°C) Type T (0 to 400°C)
Input Impedance		1 MΩ minimum	10Ω	1 MΩ minimum	1 MΩ minimum
Input Detection Current		—	—	1.0 mA maximum	—
AD Conversion	Sampling Duration Time	10 ms maximum		20 ms maximum	10 ms maximum
	Sampling Repetition Time	20 ms maximum		40 ms maximum	20 ms maximum
	Total Input System Transfer Time	60 ms + 1 scan time		80 ms + 1 scan time	60 ms + 1 scan time
	Type of Input	Single-ended input	Differential input		
	Operating Mode	Self-scan			
	Conversion Method	Σ Δ type ADC			
Input Error	Maximum Error at 25°C	±0.2% of full scale			±0.2% of full scale plus cold junction compensation error (±4°C maximum)
	Temperature Coefficient	±0.006% of full scale /°C			
	Repeatability after Stabilization Time	±0.5% of full scale			
	Non-linearity	±0.2% of full scale			
	Maximum Error	±1% of full scale			
Data	Digital Resolution	4096 increments (12 bits)		6,000 increments (14 bits)	Type K: 13,000 increments (14 bits) Type J: 12,000 increments (14 bits) Type T: 4,000 increments (14 bits)
	Input Value of LSB	2.5 mV	4 μA	0.1°C	Type K: 0.1°C Type J: 0.1°C Type T: 0.1°C
	Data Type in Application Program	Default: 0 to 4,095 Optional: -32,768 to 32,767 (selectable for each channel) ¹			
	Monotonicity	Yes			
	Input Data Out of Range	Detectable ²			
Noise Resistance	Maximum Temporary Deviation during Electrical Noise Tests	±3% maximum when a 500V clamp voltage is applied to the power supply and I/O lines ³			
	Input Filter	No			
	Recommended Cable for Noise Immunity	Twisted pair shielded cable		—	
	Crosstalk	2 LSB maximum			
Isolation	Between input and power circuit: Isolated Between input and internal circuit: Photocoupler-isolated				
Effect of Improper Input Connection	No damage				
Maximum Permanent Allowed Overload (No Damage)	13V DC	40 mA	—		
Selection of Analog Input Signal Type	Using programming software				
Calibration or Verification to Maintain Rated Accuracy	Impossible				

 1: The data processed in the analog I/O module can be linear-converted to a value between -32,768 and 32,767. The optional range designation, and analog I/O data minimum and maximum values can be selected using data registers allocated to analog I/O modules.
 2: When an error is detected, a corresponding error code is stored to a data register allocated to analog I/O operating status.
 3: The accuracy of the thermocouple input is not guaranteed when noise is applied.

OI Touchscreens
 PLCs
 Automation Software
 Power Supplies
 Sensors
 Communication
 Barriers

Analog Input Specifications (2)

Model	FC4A-J4CN1, FC4A-J8C1		FC4A-J4CN1		FC4A-J8AT1	
Input Signal Type	Voltage Input	Current Input	Thermocouple	Resistance Thermometer	NTC Thermistor	PTC Thermistor
Input Range	0 to 10V DC	4 to 20 mA	Type K (0 to 1,300°C) Type J (0 to 1,200°C) Type T (0 to 400°C)	Pt100, Pt1000 3-wire type (-100 to 500°C) Ni100, Ni1000 3-wire type (-60 to 180°C)	-50 to 150°C	
Input Impedance	1 MΩ	7 Ω (FC4A-J4CN1) 100Ω (FC4A-J8C1)	1 MΩ	—	—	
Input Detection Current	—	—	—	0.1 mA	0.1 mA	
AD Conversion	Sampling Duration Time	2 ms maximum				
	Sampling Repetition Time	FC4A-J4CN1: 10 ms maximum		30 ms maximum	10 ms maximum	2 ms × channels
		FC4A-J8C1: 2 ms maximum				
	Total Input System Transfer Time	FC4A-J4CN1: 50 ms × channels + 1 scan time FC4A-J8C1: 8 ms × channels + 1 scan time		85 ms × channels + 1 scan time	50 ms × channels + 1 scan time	10 ms × channels + 1 scan time
	Type of Input	Single-ended input				
	Operating Mode	Self-scan				
	Conversion Method	Σ Δ type ADC (FC4A-J4CN1), Successive approximation register method (FC4A-J8C1, FC4A-J8AT1)				
Input Error	Maximum Error at 25°C	±0.2% of full scale		±0.2% of full scale + cold junction compensation error (±3°C maximum)	Pt100, Ni100: ±0.4% of full scale Pt1000, Ni1000: ±0.2% of full scale	±0.2% of full scale
	Cold Junction Compensation Error	—	—	±3°C maximum	—	—
	Temperature Coefficient	±0.005% of full scale/°C				
	Repeatability after Stabilization Time	±0.5% of full scale				
	Non-linearity	±0.04% of full scale				Non-linear
	Maximum Error	±1% of full scale				
Data	Digital Resolution	50,000 increments (16 bits)		Type K: Approx. 24,000 increments (15 bits) Type J: Approx. 33,000 increments (15 bits) Type T: Approx. 10,000 increments (14 bits)	Pt100: Approx. 6,400 increments (13 bits) Pt1000: Approx. 64,000 increments (16 bits) Ni100: Approx. 4,700 increments (13 bits) Ni1000: Approx. 47,000 increments (16 bits)	Approx. 4,000 increments (12 bits)
	Input Value of LSB	0.2 mV	0.32 μA	Type K: 0.058°C Type J: 0.038°C Type T: 0.042°C	Pt100: 0.086°C Pt1000: 0.0086°C Ni100: 0.037°C Ni1000: 0.0037°C	0.05°C
Data Type in Application Program	Default: 0 to 50,000 Optional: -32,768 to 32,767 (selectable for each channel) ¹		Default: 0 to 4,000 Optional: -32,768 to 32,767 (selectable for each channel) ¹ Resistance: 0 to 10,000 Temperature: °C, °F			—
	Monotonicity	Yes				
Input Data Out of Range	Detectable ²					

 1: The data processed in the analog I/O module can be linear-converted to a value between -32,768 and 32,767. The optional range designation, and analog I/O data minimum and maximum values can be selected using data registers allocated to analog I/O modules.

Analog Input Specifications (2) con't on next page.

I/O Touchscreens

PLCs

Automation Software

Power Supplies

Sensors

Communication

Barriers

Analog Input Specifications (2), con't

Model	FC4A-J4CN1, FC4A-J8C1		FC4A-J4CN1		FC4A-J8AT1		
Noise Resistance	Maximum Temporary Deviation during Electrical Noise Tests	±3% maximum (when a 500V clamp voltage is applied to the power supply and I/O lines)			Not assured		±3% maximum (when a 500V clamp voltage is applied to the power supply and I/O lines)
	Input Filter	Software					
	Recommended Cable for Noise Immunity	Twisted pair cable		—			
	Crosstalk	2 LSB maximum					
Isolation	Between input and power circuit: Isolated		Between input and internal circuit: Optocoupler-isolated				
Effect of Improper Input Connection	No damage						
Maximum Permanent Allowed Overload (No Damage)	11V DC	22 mA DC	—				
Selection of Analog Input Signal Type	Using programming software						
Calibration or Verification to Maintain Rated Accuracy	Impossible						

Analog Output Specifications

Model	FC4A-K4A1		FC4A-L03A1		FC4A-L03AP1		FC4A-K1A1		FC4A-K2C1			
Output Range	Voltage	0 to 10V DC								-10 to 10V DC		
	Current	4 to 20 mA										
Load	Impedance	Voltage output: 1 kΩ minimum Current output: 300Ω maximum										
	Load Type	Resistive load										
DA Conversion	Settling Time	2 ms/ch	10 ms	10 ms	10 ms	10 ms	10 ms	10 ms	1 ms/ch			
	Total Output System Transfer Time	2 ms/ch + 1 scan time	10 ms + 1 scan time	10 ms + 1 scan time	10 ms + 1 scan time	10 ms + 1 scan time	10 ms + 1 scan time	10 ms + 1 scan time	1 ms × channels + 1 scan time			
Output Error	Maximum Error at 25°C	±0.2% of full scale										
	Temperature Coefficient	±0.015% of full scale/°C								±0.005% of full scale/°C		
	Repeatability after Stabilization Time	±0.5% of full scale										
	Output Voltage Drop	±1% of full scale										
	Non-linearity	±0.2% of full scale										
	Output Ripple	20 mV maximum								±0.1% of full scale		
	Overshoot	0%										
Total Error	±1% of full scale											
Data	Digital Resolution	4096 increments (12 bits)								50,000 increments (16 bits)		
	Output Value of LSB	Voltage	2.5 mV								0.4 mV	
		Current	4 μA								0.32 μA	
	Data Type in Application Program	Default: 0 to 4,095 (voltage, current)									-25,000 to 25,000 (voltage) 0 to 50,000 (current)	
		Optional: -32,768 to 32,767 (selected for each channel) ¹										
Monotonicity	Yes											
Current Loop Open	Undetectable											

 1: The data processed in the analog I/O module can be linear-converted to a value between -32,768 and 32,767. The optional range designation, and analog I/O data minimum and maximum values can be selected using data registers allocated to analog I/O modules.

Analog Input Specifications con't on next page.

Analog Output Specifications, con't

Model		FC4A-K4A1	FC4A-L03A1	FC4A-L03AP1	FC4A-K1A1	FC4A-K2C1
Noise Resistance	Maximum Temporary Deviation during Electrical Noise Tests	±3% maximum when a 500V clamp voltage is applied to the power and I/O lines				
	Recommended Cable for Noise Immunity	Twisted pair shielded cable				Twisted pair cable
	Crosstalk	2LSB maximum	None			2 LSB maximum
Isolation	Between output and power circuit	Isolated				
	Between output and internal circuit	Photocoupler-isolated				
Effect of Improper Output Connection		No damage				
Selection of Analog Output Signal Type		Using software programming				
Calibration or Verification to Maintain Rated Accuracy		Impossible				

PID Module Specifications

Model		FC5A-F2MR2	FC5A-F2M2
Control Mode	Independent PID Control	Possible	
	Heating/Cooling Control	Possible (overlapping deadband settings available) *	
	Difference Input Temperature Control	Possible *	
	Cascade Control	Possible *	
Input Points		2ch	2ch
Types of Inputs	Thermocouple	K, J, R, S, B, E, T, N, PL-II, C (W/Re5-26) External resistance: 100Ω maximum However, external resistance of B input: 40Ω maximum	
	Resistance Thermometer	Pt100, JPt100, 3-wire type Allowable conductor resistance (per wire): 10Ω maximum	
	Current Input	0 to 20 mA DC, 4 to 20 mA DC Input impedance: 50Ω Maximum permanent allowed overload (no damage): 50 mA maximum	
	Voltage Input	0 to 1V DC Input impedance: 1MΩ minimum Maximum permanent allowed overload (No damage): 5V DC Allowable output impedance: 2 kΩ 0 to 5V DC, 1 to 5V DC, 0 to 10V DC Input impedance: 100kΩ minimum Maximum permanent allowed overload (No damage): 15V DC maximum Allowable output impedance: 100Ω maximum	
AD Conversion	Sampling Duration Time	100 ms	
	Sampling Repetition Time	125 ms	
	Type of Input	Differential input	
	Conversion Method	Σ Δ type ADC	
Maximum Error at 25°C	Thermocouple Input	±0.2% of full scale or ±2°C (4°F), whichever is greater However, R, S inputs: 0 to 200°C (0 to 400°F): ±6°C (12°F) B input: 0 to 300°C (0 to 600°F) Accuracy is not guaranteed. K, J, E, T, N inputs: Less than 0°C (32°F): ±0.4% of full scale	
	Resistance Thermometer Input	±0.1% of full scale or ±1°C (2°F), whichever is greater	
	Voltage/Current Inputs	±0.2% of full scale	
Input Accuracy (at 0 to 55°C)	Thermocouple Input	±0.7% of full scale However, R, S input: 0 to 200°C (0 to 400°F): ±6°C (12°F) B input: 0 to 300°C (0 to 600°F) Accuracy is not guaranteed. K, J, E, T, N inputs: Less than 0°C (32°F): ±0.9% of full scale	
	Resistance Thermometer Input	±0.6% of full scale	
	Voltage/Current Inputs	±0.7% of full scale	



*Dual channel input is required for one loop circuit.

PID Module Specifications con't on next page.

I/O Touchscreens

PLCs

Automation Software

Power Supplies

Sensors

Communication

Barriers

PID Module Specifications, con't

Model		FC5A-F2MR2	FC5A-F2M2
Noise Resistance	Maximum Temporary Deviation during Electrical Noise Tests	Voltage input, current input ±3% maximum when a 500V clamp voltage is applied to the power supply and I/O lines Thermocouple, Resistance Thermometer Not assured	
	Input Filter	None	
	Recommended Cable for Noise Immunity	Twisted pair cable	
	Cross Talk	None	
Isolation		Between input and power circuit: Transformer Isolated Between input and internal circuit: Optocoupler isolated	
Data Accuracy		Maximum error at 25°C±Minimum digital resolution of each input range	
Cold Junction Temperature Compensation Accuracy		±1°C at 0 to 55°C	
Sampling Period		125 ms	
Output Points		2ch	
Output		Relay output 1NO Rated load 5A 250V AC/30V DC (resistive load) 3A 250V AC (inductive load cos φ=0.4) Minimum open/closed load: 10 mA 5V DC Electrical life: 100,000 cycles (at the maximum rating of resistive load)	Non-contact voltage output (for SSR drive) 12V DC±15% Maximum 40 mA (short circuit protected) Leakage current: 0.3 mA maximum Analog current output 4 to 20 mA DC Maximum Error: ±0.5% Full Scale at 25°C ±1.0% Full Scale at 55°C Load resistance: 550Ω maximum Analog output digital resolution: 1,000 LSB input value: 0.016 mA
Noise Resistance	Maximum Temporary Deviation during Electrical Noise Tests	—	±3% maximum when a 500V clamp voltage is applied to the power supply and I/O lines
	Recommended Cable for Noise Immunity	—	Twisted pair cable
	Cross Talk	—	None
Isolation		Between output and power circuit: Transformer Isolated	Between output and power circuit: Transformer Isolated Between output and internal circuit: Optocoupler isolated
Power Voltage		24V DC (External power), 5V DC (Internal power)	
Allowable Voltage Range		20.4 to 28.8V DC	
External Power Consumption		Approx. 3.5W maximum	
Internal Power Consumption (at 24V DC while all I/Os are on)		65mA (5V DC)	
Connector on Mother Board		Input: F6018-17P (Fujicon)	Output: F6018-11P (Fujicon)
Weight (approx.)		140g	

Input Range

Input	Input Range (Digital Resolution)	Input Value of LSB
K	-200 to 1,370°C	-328 to 2,498°F
	-200.0 to 400.0°C	-328.0 to 752.0°F
J	-200 to 1,000°C	-328 to 1,832°F
R	0 to 1,760°C	32 to 3,200°F
S	0 to 1,760°C	32 to 3,200°F
B	0 to 1,820°C	32 to 3,308°F
E	-200 to 800°C	-328 to 1,472°F
T	-200.0 to 400.0°C	-328.0 to 752.0°F
N	-200 to 1,300°C	-328 to 2,372°F
PL-II	0 to 1,390°C	32 to 2,534°F
	0 to 2,315°C	32 to 4,199°F
Pt100	-200.0 to 850.0°C	-328.0 to 1,562.0°F
	-200 to 850°C	-328 to 1,562°F
JPt100	-200.0 to 500.0°C	-328.0 to 932.0°F
	-200 to 500°C	-328 to 932°F
4 to 20mA DC	-2,000 to 10,000 (12,000 increments)	1.333 μA
0 to 20mA DC	-2,000 to 10,000 (12,000 increments)	1.666 μA
0 to 1V DC	-2,000 to 10,000 (12,000 increments)	0.083 mA
0 to 5V DC	-2,000 to 10,000 (12,000 increments)	0.416 mA
1 to 5V DC	-2,000 to 10,000 (12,000 increments)	0.333 mA
0 to 10V DC	-2,000 to 10,000 (12,000 increments)	0.833 mA

Expansion Interface Module Specifications

Type No.	FC5A-EXM1M (Expansion Interface Master Module)	FC5A-EXM1S (Expansion Interface Slave Module)	FC5A-EXM2 (Expansion Interface Module)
Rated Power Voltage	—	24V DC (supplied from external power)	24V DC (supplied from external power)
Allowable Voltage Range	—	20.4 to 26.4V DC (including ripple)	20.4 to 26.4V DC (including ripple)
Current Draw (Internal Power/External Power)	Internal power (supplied from CPU module): 90 mA (5V DC) 0 mA (24V DC)	Internal power (supplied from CPU module): 0 mA (5V DC) 0 mA (24V DC) External power: With I/O modules 750 mA (26.4V DC) ¹	Internal power (supplied from CPU module): 50 mA (5V DC) 0 mA (24V DC) External power: With I/O modules 750 mA (26.4V DC) ¹
Maximum Power Consumption (External Power) ¹	—	19W (26.4V DC)	19W (26.4V DC)
Allowable Momentary Power Interruption	—	10 ms minimum (24V DC)	10 ms minimum (24V DC)
I/O Expansion	Between CPU module and expansion interface module Connectable CPU modules: FC5A-D16RK1/D16RS1/D32K3/D32S3/D12K1E/D12S1E Connectable I/O modules: 7 maximum Beyond the expansion interface module Connectable I/O modules: 8 digital I/O modules maximum (AC input modules are not applicable) ²		
Maximum I/O Refresh Time ³	3.6 ms		2.8 ms
Communication between CPU Module and Expansion Interface Module	Asynchronous communication (I/O refresh of I/O modules on both sides of the expansion interface module is asynchronous.)		
Isolation from Internal Circuit	Only communication interface part is isolated		Not isolated
EMC Compliant Cable Length	1m (FC5A-KX1C)		—
Power Supply Connector	Connector on Mother Board	—	MKDSN1.5/3-5.08-BK (Phoenix Contact)
	Connector Insertion/Removal Durability	—	100 times minimum
Expansion Cable Connector	Connector on Mother Board	FCN-365P024-AU (Fujitsu Component)	
	Connector Insertion/Removal Durability	100 times minimum	
Weight	70g	135g	140g

- 1: Power consumption by the expansion interface module and eight I/O modules.
- 2: The maximum number of relay outputs that can be turned on simultaneously is 54 points.
- 3: Maximum I/O refresh time of the expansion interface module. D8252 stores the refresh time.

Dimensions (mm)

FC5A-D16RK1, FC5A-D16RS1,
FC4A-D20RK1, FC4A-D20RS1

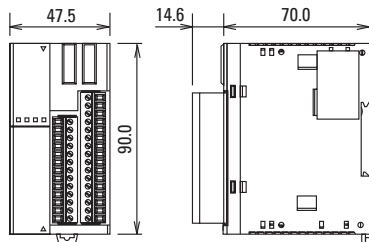

FC5A-D32K3, FC5A-D32S3, FC4A-D40K3,
FC4A-D40S3

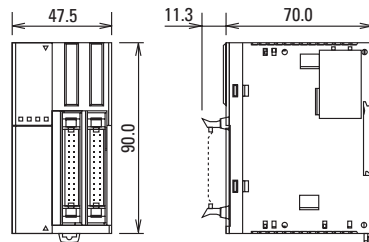

FC5A-D12K1E, FC5A-D12S1E

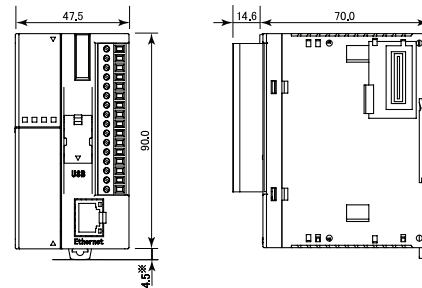

FC5A-C10R2, FC5A-C16R2,
FC5A-C10R2C, FC5A-C16R2C,
FC5A-C10R2D, FC5A-C16R2D,
FC4A-C10R2, FC4A-C16R2,
FC4A-C10R2C, FC4A-C16R2C

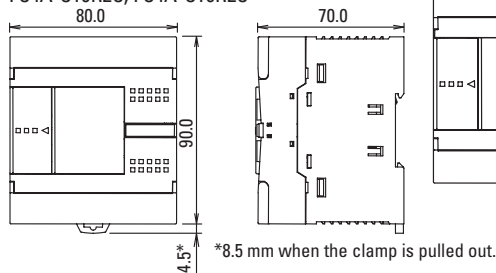

FC5A-C24R2, FC5A-C24R2C, FC5A-C24R2D,
FC4A-C24R2, FC4A-C24R2C

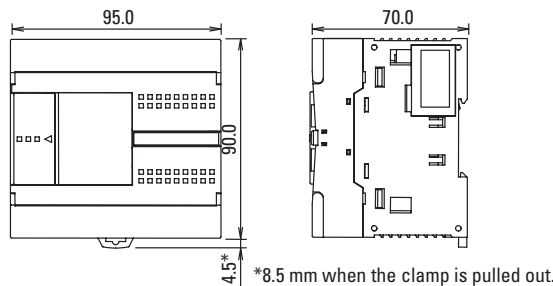

FC4A-D20K3, FC4A-D20S3

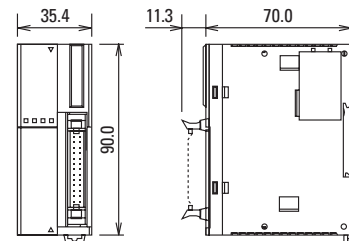

I/O Touchscreens

PLCs

Automation Software

Power Supplies

Sensors

Communication

Barriers

Dimensions cont. (mm)

01 Touchscreens

FC5A-SIF2, FC5A-SIF4,
FC4A-AS62M, FC4A-N08A11,
FC4A-J2A1, FC4A-N08B1,
FC4A-K1A1, FC4A-R081,
FC4A-K2C1, FC4A-T08K1,
FC4A-L03A1, FC4A-T08S1,
FC4A-L03AP1, FC4A-K4A1,
FC4A-M08BR1

FC4A-N16B3, FC4A-T16K3, FC4A-T16S3

FC4A-N16B1, FC4A-R161, FC4A-J4CN1,
FC4A-J8C1, FC4A-J8AT1

PLCs

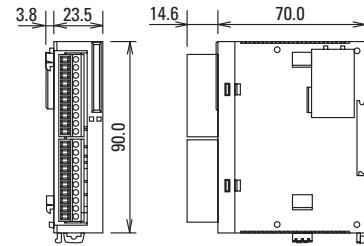
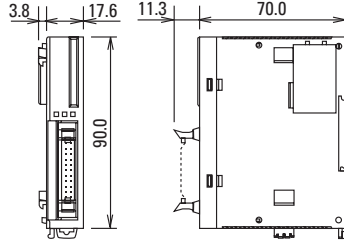
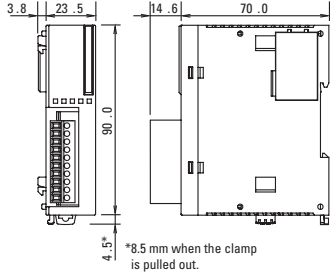

Automation Software

FC5A-F2MR2, FC5A-F2M2, FC4A-M24BR2

FC4A-N32B3, FC4A-T32K3, FC4A-T32S3

FC4A-HPC1, FC4A-HPC2, FC4A-HPC3

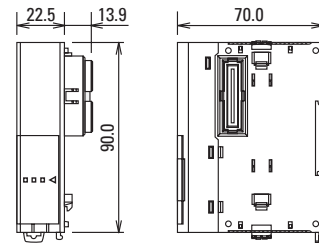
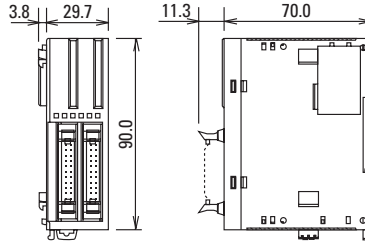
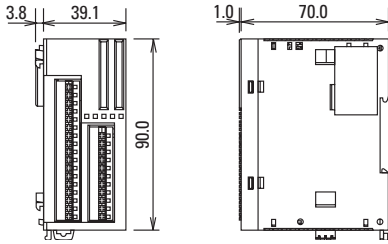

Power Supplies

FC4A-HPH1

FC4A-SX5ES1E

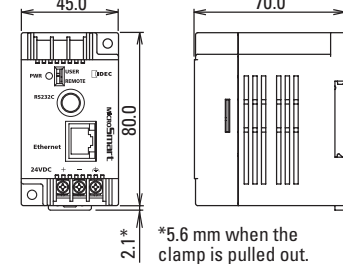
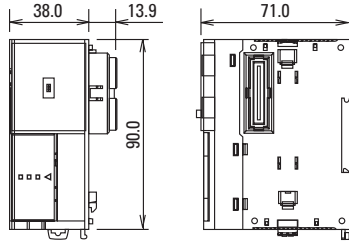

Sensors

FC5A-EXM2

FC5A-EXM1M

FC5A-EXM1S

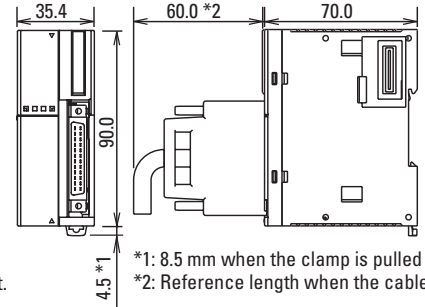
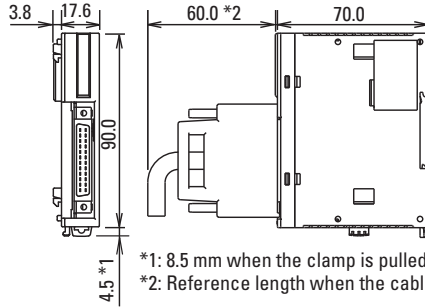
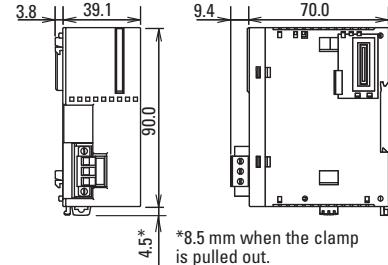

Communication

Example

The following figure illustrates a system setup consisting of the all-in-one 24-I/O type CPU module, an 8-point relay output module, and a 16-point DC input module mounted on a 35-mm-wide-DIN rail using BNL6 end clips.

Barriers

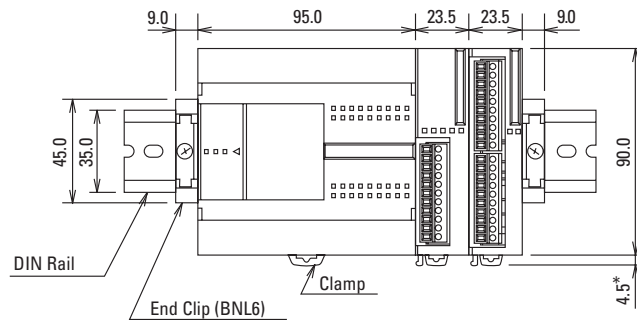

*8.5 mm when the clamp is pulled out.

Mounting Hole Layouts

FC5A-C10R2, FC5A-C10R2C,
FC5A-C10R2D, FC5A-C16R2,
FC5A-C16R2C, FC5A-C16R2D
FC4A-C10R2, FC4A-C10R2C
FC4A-C16R2, FC4A-C16R2C

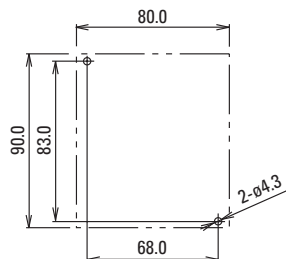

FC5A-C24R2
FC5A-C24R2C
FC5A-C24R2D
FC4A-C24R2
FC4A-C24R2C

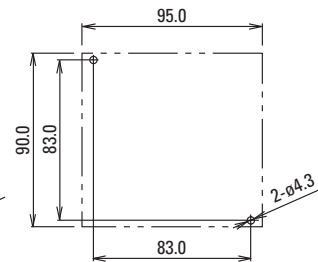

FC5A-D12K1E, FC5A-D12S1E
FC5A-D16R1, FC5A-D16RS1
FC5A-D32K3, FC5A-D32S3
FC4A-D20R1, FC4A-D20RS1
FC4A-D40K3, FC4A-D40S3

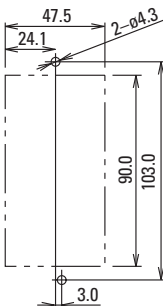

FC5A-SIF2, FC5A-SIF4
FC4A-AS62M, FC4A-N08A11,
FC4A-J2A1, FC4A-N08B1,
FC4A-J4CN1, FC4A-N16B1,
FC4A-J8AT1, FC4A-R081, FC4A-
J8C1, FC4A-R161, FC4A-K1A1,
FC4A-T08K1, FC4A-K2C1, FC4A-
T08S1, FC4A-L03A1, FC4A-K4A1,
FC4A-L03AP1, FC4A-M08BR1

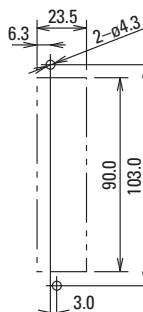

FC4A-SX5ES1E

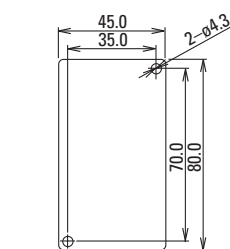

FC4A-N32B3
FC4A-T32K3
FC4A-T32S3

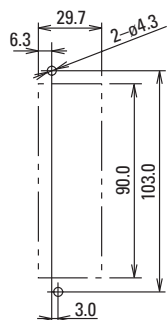

FC5A-F2MR2
FC5A-F2M2
FC5A-EXM2
FC4A-M24BR2

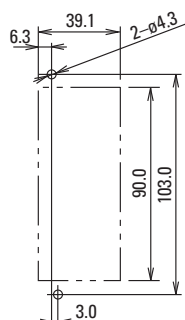

FC5A-EXM1S
FC4A-D20K3
FC4A-D20S3

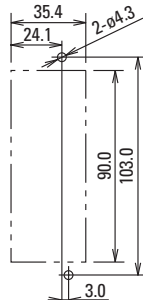

FC5A-EXM1M
FC4A-N16B3
FC4A-T16K3
FC4A-T16S3

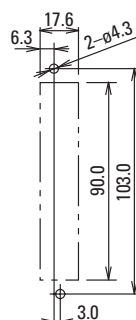

FC4A-HPC1
FC4A-HPC2
FC4A-HPC3

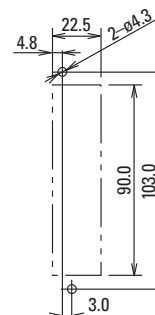

FC4A-HPH1

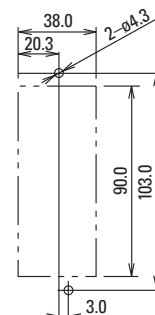

Example

Mounting hole layout for FC5A-C24R2 or FC4A-C24R2 and four 23.5mm-wide I/O modules

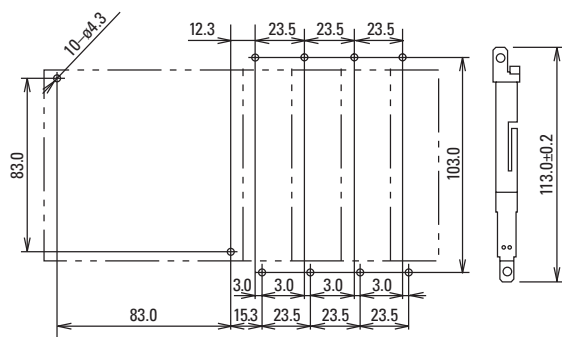

Example

Mounting hole layout from left, FC4A-HPH1, FC4A-D20K3, FC4A-N16B3, FC4A-N32B3, and FC4A-M24R2 modules

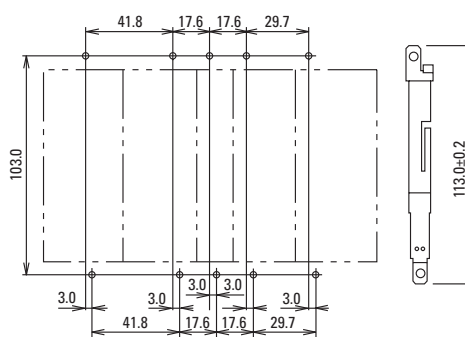

All dimensions in mm.

OI Touchscreens

PLCs

Automation Software

Power Supplies

Sensors

Communication

Barriers

X-ON Electronics

Largest Supplier of Electrical and Electronic Components

Click to view similar products for [Interface Modules](#) category:

Click to view products by [Idec](#) manufacturer:

Other Similar products are found below :

[IFD8520](#) [cPCI-3544](#) [422CON](#) [ATX6022/14GP7](#) [ATX6022/8](#) [AX93221-24/48](#) [FC6A-EXM2](#) [OPT8AP-AE](#) [96RMKVM-19V1C-A](#) [60016-011](#) [60016-014](#) [60006-008](#) [60011-075](#) [HPCI-14S12U](#) [cBP-3208](#) [cBP-3062A](#) [FAB205-6P5](#) [ATX6022/6](#) [60016-012](#) [96RMKVM-17V1C-A](#) [MOS-1120Y-0201E](#) [96RMLCD-17V1-A](#) [96RMKVM-17V8C-A](#) [60004-005](#) [60016-017](#) [60006-009](#) [60016-035](#) [60016-034](#) [60016-031](#) [60016-030](#) [60016-026](#) [60016-024](#) [60016-018](#) [60016-007](#) [60016-005](#) [60007-002](#) [60006-010](#) [AXX10GBTWLHW3](#) [382-BBEH](#) [555-BDCL](#) [K6CMISZBI52](#) [426451401-3](#) [60011-093](#) [MIC-3620/3-BE](#) [MPCIE-UART-KIT02-R20](#) [RSM232](#) [PCIE-1680-AE](#) [BB-FOSTCDRI](#) [73-544-002](#) [UC-313](#)