

## L6 Series – Miniature Switches and Pilot Devices

**Key features of the 5/8" L6 Series include:**

- 5/8" (16mm) mounting holes
- Locking lever removable contact blocks
- Solder terminal or PCB terminal options
- Available assembled or as sub-components
- Worldwide approvals
- Incandescent or LED illumination
- Snap action contacts



UL Recognized  
File No. E55996



CSA Certified  
File No. LR21451



Registration No. R9551089 (E-stops)  
Registration No. J9551458 (all other switches)  
Registration No. R95650511 (Pilot Lights)

Contact Ratings	Conforming to Standards	EN60947-1, EN60947-5-1, VDE0660-200, UL508, CSA C22-2 NO.14																																		
	Operating Temperature	Operation: -25 to +55°C (without freezing), 45 to 85% RH Storage: -30 to +80°C (without freezing)																																		
	Vibration Resistance	5 to 55Hz, 1.0 peak-peak amplitude max																																		
	Shock Resistance	Operating limit: 100 m/sec <sup>2</sup> (approximately 10G) Damage limit: 1000 m/sec <sup>2</sup> (approximately 100G)																																		
	Mechanical Life	Momentary pushbuttons 2,000,000 operations minimum All others: 250,000 operations minimum																																		
	Degree of Protection	IP65 (conforming to IEC 60529)																																		
	Dielectric Strength	Switch unit: between live and ground: 2500 volt AC, 1 minute between terminals of different poles: 2500 volt AC, 1 minute between terminals of same pole: 1000 volt AC, 1 minute Illumination unit: between live part and ground: 2500 volt AC, 1 minute																																		
	Insulation Resistance	100MΩ minimum (using 500V DC megger)																																		
	Rated Insulation Voltage	250V AC/DC																																		
	Rated Thermal Current	Gold Contacts (pcb): 3A Silver Contacts (solder): 5A																																		
	Contact Resistance	50Ω maximum initial value																																		
	Rated Operating Current	<b>Silver Contacts</b> (Solder Terminals) <table border="1"> <thead> <tr> <th></th> <th>30V</th> <th>125V</th> <th>250V</th> </tr> </thead> <tbody> <tr> <td>AC resistive</td> <td>—</td> <td>5A</td> <td>2A</td> </tr> <tr> <td>AC inductive</td> <td>—</td> <td>2A</td> <td>1.5A</td> </tr> <tr> <td>DC resistive</td> <td>3A</td> <td>0.4A</td> <td>—</td> </tr> <tr> <td>DC inductive</td> <td>1A</td> <td>0.2A</td> <td>—</td> </tr> </tbody> </table>				30V	125V	250V	AC resistive	—	5A	2A	AC inductive	—	2A	1.5A	DC resistive	3A	0.4A	—	DC inductive	1A	0.2A	—	<b>Gold Clad Contacts</b> (PCB terminals) <table border="1"> <thead> <tr> <th></th> <th>30V</th> <th>125V</th> </tr> </thead> <tbody> <tr> <td>AC inductive</td> <td>-</td> <td>0.1A</td> </tr> <tr> <td>DC resistive</td> <td>0.1A</td> <td>—</td> </tr> </tbody> </table>				30V	125V	AC inductive	-	0.1A	DC resistive	0.1A	—
		30V	125V	250V																																
AC resistive	—	5A	2A																																	
AC inductive	—	2A	1.5A																																	
DC resistive	3A	0.4A	—																																	
DC inductive	1A	0.2A	—																																	
	30V	125V																																		
AC inductive	-	0.1A																																		
DC resistive	0.1A	—																																		
Minimum Recommended Load (reference value for silver contacts)	5V AC/DC, 1mA																																			
Terminal Style	0.110" Solder Tab /PCB																																			
Contact Form	Snap Action, Double Throw																																			
Contact Material	Solder Tab: Pure Silver /PCB: Gold Plated Silver																																			
Electrical Life (at full load)	Momentary pushbuttons: 100,000 operations minimum (1800 operations / hour) All others: 100,000 operations minimum (1200 operations / hour)																																			
Lamp Ratings	Lamp Current Draw	5V DC LED: 8mA 6V AC/DC LED: 7mA 12V AC/DC LED: 8mA 24V AC/DC LED: 8mA 120V AC = 8mA		6V AC/DC incandescent: 100 mA 12V AC/DC incandescent: 50 mA 24V AC/DC incandescent: 25 mA																																
	Lamp Life	Incandescent: 2000 hours./LED 50,000 hours. (on pure DC, half-life intensity)																																		

Switches & Pilot Lights

Display Lights





Relays & Sockets

Timers

Terminal Blocks



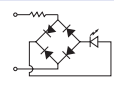
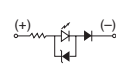
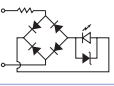

Circuit Breakers





**Built-in LED Lamp Ratings**

Model	LFTD-5②	LFTD-1②	LFTD-2②	LFTD-H2②
Lamp Base	SX6S/8x5.4			
Rated Voltage	5V DC	12V AC/DC	24V AC/DC	120V AC
Operating Voltage	5V DC ±5%	12V AC/DC ±10%	24V AC/DC ±10%	120V AC ±5%
Current Draw	AC	9mA	9mA	8mA
	DC	8mA	8mA	—
Color Code ②	Specify a color code in place of ② in the Part No: A (amber), G (green), R (red), S (blue), W (white), Y (yellow)			
Lamp Base Color	Same as illumination color			
Voltage Marking	Stamped on the lamp base			
Life (reference value)	Approx. 50,000 hours			
Internal Circuit	A, R, W, Y	A, R, W, Y		 LED Chip  Protection Diode  Zener Diode
				
	G, S	G, S		
				

**Non-Illuminated Pushbuttons (Assembled)**

**Non-Illuminated Pushbuttons**

Style	Operation	Contact	Terminal Style	
			Solder Tab	PCB
 Round	Momentary	SPDT	LA1B-M1C5-①	LA1B-M1C1V-①
		DPDT	LA1B-M1C6-①	LA1B-M1C2V-①
	Maintained	SPDT	LA1B-A1C5-①	LA1B-A1C1V-①
		DPDT	LA1B-A1C6-①	LA1B-A1C2V-①
 Square	Momentary	SPDT	LA2B-M1C5-①	LA2B-M1C1V-①
		DPDT	LA2B-M1C6-①	LA2B-M1C2V-①
	Maintained	SPDT	LA2B-A1C5-①	LA2B-A1C1V-①
		DPDT	LA2B-A1C6-①	LA2B-A1C2V-①
 Rectangular	Momentary	SPDT	LA3B-M1C5-①	LA3B-M1C1V-①
		DPDT	LA3B-M1C6-①	LA3B-M1C2V-①
	Maintained	SPDT	LA3B-A1C5-①	LA3B-A1C1V-①
		DPDT	LA3B-A1C6-①	LA3B-A1C2V-①
 Oversize Round Flush	Momentary	SPDT	HA1B-M1C5-①	HA1B-M1C1V-①
		DPDT	HA1B-M1C6-①	HA1B-M1C2V-①
	Maintained	SPDT	HA1B-A1C5-①	HA1B-A1C1V-①
		DPDT	HA1B-A1C6-①	HA1B-A1C2V-①

Style	Operation	Contact	Terminal Style	
			Solder Tab	PCB
 Oversize Round Extended	Momentary	SPDT	HA1B-M2C5-①	HA1B-M2C1V-①
		DPDT	HA1B-M2C6-①	HA1B-M2C2V-①
	Maintained	SPDT	HA1B-A2C5-①	HA1B-A2C1V-①
		DPDT	HA1B-A2C6-①	HA1B-A2C2V-①
 Oversize Square Flush	Momentary	SPDT	HA2B-M1C5-①	HA2B-M1C1V-①
		DPDT	HA2B-M1C6-①	HA2B-M1C2V-①
	Maintained	SPDT	HA2B-A1C5-①	HA2B-A1C1V-①
		DPDT	HA2B-A1C6-①	HA2B-A1C2V-①
 Oversize Square Extended	Momentary	SPDT	HA2B-M2C5-①	HA2B-M2C1V-①
		DPDT	HA2B-M2C6-①	HA2B-M2C2V-①
	Maintained	SPDT	HA2B-A2C5-①	HA2B-A2C1V-①
		DPDT	HA2B-A2C6-①	HA2B-A2C2V-①
 Mushroom	Momentary	SPDT	HA1B-M3C5-①	HA1B-M3C1V-①
		DPDT	HA1B-M3C6-①	HA1B-M3C2V-①
	Maintained	SPDT	HA1B-A3C5-①	HA1B-A3C1V-①
		DPDT	HA1B-A3C6-①	HA1B-A3C2V-①

- In place of ① specify Button Color Code from table.
- Illuminated (translucent) style lenses also available, specify as such: instead of LA1B-M1C5-① use LA1B-M1C5L-② in place of ② (specify Lens Color Code from next page.)
- PCB terminal models also available with silver contacts (change "1" or "2" to "5" or "6" respectively, ie LA1B-M1C1V-① becomes LA1B-M1C5V-①).

**① Button Color Codes**

Color	Code	Color	Code
Black	B	Blue	S
Green	G	White	W
Red	R	Yellow	Y



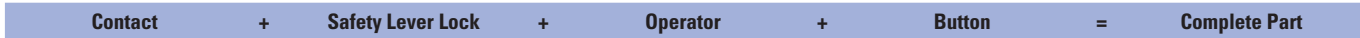





Non-Illuminated Pushbuttons (Sub-Assembled)



Operators

Style	Momentary	Maintained
Round 	LA1L-MO	LA1L-AO
Square 	LA2L-MO	LA2L-AO
Rectangular 	LA3L-MO	LA3L-AO
Oversize Round 	HA1B-MO	HA1B-AO
Oversize Square 	HA2B-MO	HA2B-AO
Mushroom 	HA1B-MOL	HA1B-AOL

Buttons/Lenses

Style	Button	Lens
Round 	AB6M-BK2-①	AL6M-LK2-②
Square 	AB6Q-BK2-①	AL6Q-LK2-②
Rectangular 	AB6H-BK2-①	AL6H-LK2-②
Oversize Round Flush 	HA1A-B1-①	HA1A-L1-②*
Oversize Round Extended 	HA1A-B2-①	-
Oversize Square Flush 	HA2A-B1-①	HA2A-L1-②**
Oversize Square Extended 	HA2A-B2-①	-
Mushroom 	HA1A-B3-①	HA1A-L3-②

Contacts

Appearance	Contacts	Terminal Style	
		Solder Tab	PCB
	Gold SPDT DPDT	HA-C1 HA-C2	HA-C1V HA-C2V
		Silver SPDT DPDT	HA-C5 HA-C6

Safety Lever Lock

Appearance	Part Number
	HA9Z-LS

① Button Color Code

Color	Code
Black	B
Green	G
Red	R
Blue	S
White	W
Yellow	Y

② Lens Color Code

Color	Code
Amber	A
Green	G
Red	R
Blue	S
Yellow	Y
White	W



- In place of ① specify Button Color Code from table on right.
- In place of ② specify Lens Color Code from table on right.
- \*requires HA1L-MO or HA1L-AO operator instead of HA1B-MO or HA1B-AO.
- \*\*requires HA2L-MO or HA2L-AO instead of HA2B-MO or HA2B-AO.

Switches & Pilot Lights

Display Lights

Relays & Sockets

Timers

Terminal Blocks

Circuit Breakers

### HA1B/HA1E Stop Switch

**Key features:**

- PCB or Solder Terminals
- Locking Lever Removable Contact Blocks
- Positive Action Contacts
- 1 or 2 form B (SPST-NC) Contacts
- IP65 Protection
- 16mm Mounting Hole
- Tamper Proof Construction



File No. DK95-00138



CSA File No. LR21451



UL Recognized File No. E55996



Direct Opening Action

**Specifications**

Contact Form	1 or 2 form B (SPST-NC)	
Termination	PCB or Solder Terminal	
Contact Material	Silver	
Applicable Standards	EN60947-5-1, UL508, CSA 22.2. No. 14	
Rated Insulation Voltage	250V AC/DC	
Degree of Protection	IP65	
Conditional Short-Circuit Current and Short-Circuit Protective Device	50 A (at 250V) 10A 250V Fuse, operation class M according to IEC269-1 and IEC269-2	
Positive Opening Operation	Positive opening travel	3.4mm
	Minimum force required to achieve positive opening operation of all break contacts.	10.3 N (2 form B contacts)
	Maximum travel including travel beyond the minimum travel position	5.5mm
	Maximum frequency of actuation	1,200 operations/hour
Pollution Degree	3	

**Nameplates**

HAAV–Yellow Plastic

Marking	Part Number
Blank	HAAV-0

**Positive Action Stop Switch**

Style	Operation	Contact	Terminal Style	
			Solder Tab	PCB
Stop Switch 	Pushlock/Turn Reset	DPST(NC) (2 form B)	HA1B-V2E2R	HA1B-V2E2VR
		Short Body SPST-NC (1 form B) DPST-NC (2 form B)	HA1E-V2S1R HA1E-V2S2R	—

**Accessories: Shroud**

Style	Part Number	Applicable Standards
	XA9Z-KG1	SEMI S2 Compliant (Approved by TUV)

1. Button is non-removable, available in red and as complete assembled unit only.
2. Stop Switch does not come with safety lever lock.

**Buzzers (IP40)**

Style	Operating Voltage	Terminal Style	
		Solder/Tab	PCB
Buzzer-Rectangular 	6V AC/DC ± 10%	LA3Z-1X2	LA3Z-1X2V
	12V to 24 AC/DC ± 10%	LA3Z-1X4	LA3Z-1X4V

**Buzzer Ratings**

Frequency	2 khz ± 500 HZ
Amplitude	80db @ 0.1m (at rated voltage)
Operating Voltage	6V AC/DC or 12 - 24V AC/DC ± 10%
Adjustable Cycle	55 to 600 cycles per minute
Current Draw	DC: 7mA AC: 20mA
Life	1000 hrs. minimum
Insulation Voltage	60V AC/DC
Operating Temperature	-20 to 55°C (no freezing), 45 to 85% RH
Degree of Protection	IP40

Pilot Lights (Assembled)

Pilot Lights

Style	Terminal Style	
	Solder Tab	PCB
Round 	LA1P-1C0③-②	LA1P-1C0③V-②
Square 	LA2P-1C0③-②	LA2P-1C0③V-②
Rectangular 	LA3P-1C0③-②	LA3P-1C0③V-②
Oversize Round 	HA1P-1C0③-②	HA1P-1C0③V-②
Oversize Square 	HA2P-1C0③-②	HA2P-1C0③V-②
Oversize Round Unibody 	HA1P-1③-②	—
Oversize Square Unibody 	HA2P-1③-②	—

② Lens/LED Color Codes

Color	Code
Amber	A
Green	G
Red	R
Blue	S
White	W
Yellow	Y

③ Voltage/Lamp Code

Voltage	Code
5V DC LED	1
6V AC/DC LED	2
12V AC/DC LED	3
24V AC/DC LED	4
120V AC LED	8
6V AC/DC Incandescent	5
12V AC/DC Incandescent	6
24V AC/DC Incandescent	7



1. In place of ② specify Lens/LED Color Code from table.
2. In place of ③ specify Voltage Code from table.
3. Lamps also available in 5VDC, 6V AC/DC, 12V AC/DC or 120V AC, change "4" or "7" using Voltage/Lamp Codes (ie LA1P-1C03-② uses 12V AC/DC LED).
4. Light independent of switch position.



**Pilot Lights (Sub-Assembled)**

Terminals + Safety Lever Lock + Lamp Holder + Lamp + Operator + Lens = Completed Unit



**Operators**

Style	Part Number
Round	LA1P-0
Square	LA2P-0
Rectangular	LA3P-0
Oversize Round	HA1P-0
Oversize Square	HA2P-0
Oversize Round Unibody	HA1P-00
Oversize Square Unibody	HA2P-00

**Lenses**

Style	Part Number
Round	AL6M-LK3-Ⓞ
Square	AL6Q-LK3-Ⓞ
Rectangular	AL6H-LK3-Ⓞ
Oversize Round	HA1A-P1-Ⓞ
Oversize Square	HA2A-P1-Ⓞ

 In place of Ⓞ specify lens color code.

**Lamps**

Style	Voltage	Part Number
LED	5V DC	LFTD-5Ⓞ
	6V AC/DC	LFTD-6Ⓞ
	12V AC/DC	LFTD-1Ⓞ
	24V AC/DC	LFTD-2Ⓞ
	120 V AC	LFTD-H2Ⓞ
Incandescent	6V AC/DC	LH-06
	12V AC/DC	LH-14
	24V AC/DC	LH-28

 In place of Ⓞ specify LED color code from table below.

**Terminals**

Appearance	Solder Tab	PCB
	HA-C00	HA-C00V

 Not required for unibody operators.

**Lamp Holder**

Appearance	Part Number
	HA9Z-AH

**Safety Lever Lock**

Appearance	Part Number
	HA9Z-LS

**Ⓞ Lens/LED Color Codes**

Color	Code
Amber	A
Green	G
Red	R
Blue	S
Yellow	Y
White	W

Switches & Pilot Lights

Display Lights

Relays & Sockets







Timers

Terminal Blocks

Circuit Breakers

Illuminated Pushbuttons (Assembled)

Illuminated Pushbuttons

Style	Operation	Contact	Terminal Style	
			Solder Tab	PCB
Round 	Momentary	SPDT DPDT	LA1L-M1C5③-② LA1L-M1C6③-②	LA1L-M1C1③V-② LA1L-M1C2③V-②
	Maintained	SPDT DPDT	LA1L-A1C5③-② LA1L-A1C6③-②	LA1L-A1C1③V-② LA1L-A1C2③V-②
Square 	Momentary	SPDT DPDT	LA2L-M1C5③-② LA2L-M1C6③-②	LA2L-M1C1③V-② LA2L-M1C2③V-②
	Maintained	SPDT DPDT	LA2L-A1C5③-② LA2L-A1C6③-②	LA2L-A1C1③V-② LA2L-A1C2③V-②
Rectangular 	Momentary	SPDT DPDT	LA3L-M1C5③-② LA3L-M1C6③-②	LA3L-M1C1③V-② LA3L-M1C2③V-②
	Maintained	SPDT DPDT	LA3L-A1C5③-② LA3L-A1C6③-②	LA3L-A1C1③V-② LA3L-A1C2③V-②
Oversize Round 	Momentary	SPDT DPDT	HA1L-M1C5③-② HA1L-M1C6③-②	HA1L-M1C1③V-② HA1L-M1C2③V-②
	Maintained	SPDT DPDT	HA1L-A1C5③-② HA1L-A1C6③-②	HA1L-A1C1③V-② HA1L-A1C2③V-②
Oversize Square 	Momentary	SPDT DPDT	HA2L-M1C5③-② HA2L-M1C6③-②	HA2L-M1C1③V-② HA2L-M1C2③V-②
	Maintained	SPDT DPDT	HA2L-A1C5③-② HA2L-A1C6③-②	HA2L-A1C1③V-② HA2L-A1C2③V-②
Mushroom 	Momentary	SPDT DPDT	HA1L-M3C5③-② HA1L-M3C6③-②	HA1L-M3C1③V-② HA1L-M3C2③V-②
	Maintained	SPDT DPDT	HA1L-A3C5③-② HA1L-A3C6③-②	HA1L-A3C1③V-② HA1L-A3C2③V-②

② Lens Color Codes

Color	Code
Amber	A
Green	G
Red	R
Blue	S
Yellow	Y
White	W

③ Voltage/Lamp Code

Voltage	Code
5V DC LED	1
6V AC/DC LED	2
12V AC/DC LED	3
24V AC/DC LED	4
120 V AC LED	8
6V AC/DC Incandescent	5
12V AC/DC Incandescent	6
24V AC/DC Incandescent	7



- In place of ② specify Lens Color Code from table.
- In place of ③ specify Voltage Code from table.
- Lamps also available in 5V DC, 6V AC/DC, 12V AC/DC or 120V AC, change "4" or "7" using voltage/lamp codes (ie LA1P-1C03-② uses 12V AC/DC LED).
- PCB terminal models also available with silver contacts change "1" or "2" to "5" or "6" respectively, (ie LA1L-M1C14V-② becomes LA1L-M1C54V-②).
- Light independent of switch position.

**Illuminated Pushbuttons (Sub-Assembled)**

Terminals + Safety Lever Lock + Lamp Holder + Lamp + Operator + Lens = Completed Unit



Switches & Pilot Lights

Display Lights

Relays & Sockets

Timers

Terminal Blocks

Circuit Breakers

**Operators**

Style	Momentary	Maintained
Round	LA1L-MO	LA1L-AO
Square	LA2L-MO	LA2L-AO
Rectangular	LA3L-MO	LA3L-AO
Oversize Round	HA1L-MO	HA1L-AO
Oversize Square	HA2L-MO	HA2L-AO
Mushroom	HA1B-MOL	HA1B-AOL

**Lenses**

Style	Part Number
Round	AL6M-LK2-Ⓢ
Square	AL6Q-LK2-Ⓢ
Rectangular	AL6H-LK2-Ⓢ
Oversize Round	HA1A-L1-Ⓢ
Oversize Square	HA2A-L1-Ⓢ
Mushroom	HA1A-L3-Ⓢ

**Lamps**

Style	Voltage	Part Number
LED	5V DC	LFTD-5Ⓢ
	6V AC/DC	LFTD-6Ⓢ
	12V AC/DC	LFTD-1Ⓢ
	24V AC/DC	LFTD-2Ⓢ
	120 V AC	LFTD-H2Ⓢ
Incandescent	6V AC/DC	LH-06
	12V AC/DC	LH-14
	24V AC/DC	LH-28

**Contacts**

Appearance	Contacts	Terminal Style	
		Solder Tab	PCB
	SPDT DPDT	HA-C10 HA-C20	HA-C10V HA-C20V
			SPDT DPDT

**Lamp Holder**

Appearance	Part Number
	HA9Z-AH

**Safety Lever Lock**

Appearance	Part Number
	HA9Z-LS

Ⓢ Lens/LED Color Codes

Color	Code
Amber	A
Green	G
Red	R
Blue	S
Yellow	Y
White	W

In place of Ⓢ specify lens color code.



Selector Switches (Assembled)

Selector Switches

Style	Position	Position Diagram	Contact	Terminal Style	
				Solder Tab	PCB
 <p>Round</p>	90° 2-Position	Maintained		DPDT	LA1S-2C6 / LA1S-2C2V
		Spring return from right		DPDT	LA1S-21C6 / LA1S-21C2V
	45° 3-Position	Maintained		DPDT	LA1S-3C6 / LA1S-3C2V
		Spring return from right		DPDT	LA1S-31C6 / LA1S-31C2V
		Spring return from left		DPDT	LA1S-32C6 / LA1S-32C2V
		2-Way spring return		DPDT	LA1S-33C6 / LA1S-33C2V
 <p>Square</p>	90° 2-Position	Maintained		DPDT	LA2S-2C6 / LA2S-2C2V
		Spring return from right		DPDT	LA2S-21C6 / LA2S-21C2V
	45° 3-Position	Maintained		DPDT	LA2S-3C6 / LA2S-3C2V
		Spring return from right		DPDT	LA2S-31C6 / LA2S-31C2V
		Spring return from left		DPDT	LA2S-32C6 / LA2S-32C2V
		2-Way spring return		DPDT	LA2S-33C6 / LA2S-33C2V
 <p>Rectangular</p>	90° 2-Position	Maintained		DPDT	LA3S-2C6 / LA3S-2C2V
		Spring return from right		DPDT	LA3S-21C6 / LA3S-21C2V
	45° 3-Position	Maintained		DPDT	LA3S-3C6 / LA3S-3C2V
		Spring return from right		DPDT	LA3S-31C6 / LA3S-31C2V
		Spring return from left		DPDT	LA3S-32C6 / LA3S-32C2V
		2-Way spring return		DPDT	LA3S-33C6 / LA3S-33C2V
 <p>Oversize Round</p>	90° 2-Position	Maintained		DPDT	HA1S-2C6 / HA1S-2C2V
		Spring return from right		DPDT	HA1S-21C6 / HA1S-21C2V
	45° 3-Position	Maintained		DPDT	HA1S-3C6 / HA1S-3C2V
		Spring return from right		DPDT	HA1S-31C6 / HA1S-31C2V
		Spring return from left		DPDT	HA1S-32C6 / HA1S-32C2V
		2-Way spring return		DPDT	HA1S-33C6 / HA1S-33C2V

Contact Operations

(for all selectors)

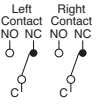
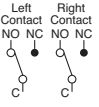
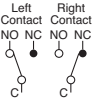
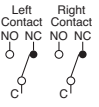
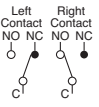
Contacts	Operator Position and Contact Operation
2-pos. (DPDT)	Left 
	Right 
3-pos. (DPDT)	Left 
	Center 
	Right 



As viewed from front of switch.



- All assembled selector switches use DPDT contacts.
- For SPDT contacts see sub-components on next page.
- PCB terminal models also available with silver contacts change "1" or "2" to "5" or "6" respectively, (ie LA1S-21C2V becomes LA1S-21C6V).



**Selector Switches (Sub-Assembled)**



**Operators**

Style	Position	Function	Part Number
Round 	2	Maintained Spring from right	LA1S-2Y LA1S-21Y
	3	Maintained Spring from right Spring from left Spring from both	LA1S-3Y LA1S-31Y LA1S-32Y LA1S-33Y
Square 	2	Maintained Spring from right	LA2S-2Y LA2S-21Y
	3	Maintained Spring from right Spring from left Spring from both	LA2S-3Y LA2S-31Y LA2S-32Y LA2S-33Y
Rectangular 	2	Maintained Spring from right	LA3S-2Y LA3S-21Y
	3	Maintained Spring from right Spring from left Spring from both	LA3S-3Y LA3S-31Y LA3S-32Y LA3S-33Y
Oversize Round 	2	Maintained Spring from right	HA1S-2Y HA1S-21Y
	3	Maintained Spring from right Spring from left Spring from both	HA1S-3Y HA1S-31Y HA1S-32Y HA1S-33Y

**Contacts**

Appearance	Contacts	Terminal Style	
		Solder Tab	PCB
	Gold SPDT DPDT	HA-C1	HA-C1V
		HA-C2	HA-C2V
	Silver SPDT DPDT	HA-C5	HA-C5V
		HA-C6	HA-C6V

-  1. All assembled switches listed on previous page use DPDT contacts.
- 2. SPDT Contacts for use on 2 position selector switch only

**Safety Lever Lock**

Appearance	Part Number
	HA9Z-LS

Key Switches (Assembled)

Key Switches

Style	Position	Position Diagram	Contact	Terminal Style	
				Solder Tab	PCB
Round 	90° 2-Position	Maintained		DPDT	LA1K-2C6③ LA1K-2C2V③
		Spring return from right		DPDT	LA1K-21C6B LA1K-21C2VB
	45° 3-Position	Maintained		DPDT	LA1K-3C6③ LA1K-3C2V③
		Spring return from right		DPDT	LA1K-31C6③ LA1K-31C2V③
		Spring return from left		DPDT	LA1K-32C6③ LA1K-32C2V③
		2-Way spring return		DPDT	LA1K-33C6D LA1K-33C2VD
Square 	90° 2-Position	Maintained		DPDT	LA2K-2C6③ LA2K-2C2V③
		Spring return from right		DPDT	LA2K-21C6B LA2K-21C2VB
	45° 3-Position	Maintained		DPDT	LA2K-3C6③ LA2K-3C2V③
		Spring return from right		DPDT	LA2K-31C6③ LA2K-31C2V③
		Spring return from left		DPDT	LA2K-32C6③ LA2K-32C2V③
		2-Way spring return		DPDT	LA2K-33C6D LA2K-33C2VD
Rectangular 	90° 2-Position	Maintained		DPDT	LA3K-2C6③ LA3K-2C2V③
		Spring return from right		DPDT	LA3K-21C6B LA3K-21C2VB
	45° 3-Position	Maintained		DPDT	LA3K-3C6③ LA3K-3C2V③
		Spring return from right		DPDT	LA3K-31C6③ LA3K-31C2V③
		Spring return from left		DPDT	LA3K-32C6③ LA3K-32C2V③
		2-Way spring return		DPDT	LA3K-33C6D LA3K-33C2VD
Oversize Round 	90° 2-Position	Maintained		DPDT	HA1K-2C6③ HA1K-2C2V③
		Spring return from right		DPDT	HA1K-21C6B HA1K-21C2VB
	45° 3-Position	Maintained		DPDT	HA1K-3C6③ HA1K-3C2V③
		Spring return from right		DPDT	HA1K-31C6③ HA1K-31C2V③
		Spring return from left		DPDT	HA1K-32C6③ HA1K-32C2V③
		2-Way spring return		DPDT	HA1K-33C6D HA1K-33C2VD

Contact Operations

(for all selectors)

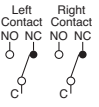
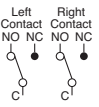
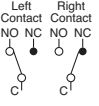
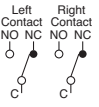
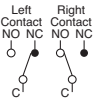
Contacts	Operator Position and Contact Operation
2-pos. (DPDT)	Left 
	Right 
3-pos. (DPDT)	Left 
	Center 
	Right 

 As viewed from front of switch.

③ Key Retention Option Codes

Code	Description
A	Key not retained in any position (removable in all positions)
B	Key retained in right position only
C	Key retained in left position only
D	Key retained in left and right (3 position only)
E	Key retained in center only (3 position only)
G	Key retained right and center (3 position only)
H	Key retained left and center (3 position only)

 Key cannot be removed from a spring-return position.

-  1. In place of ③ specify Key Retention Code from next page.
- 2. All assembled key switches have DPDT contacts. For SPDT see sub-assembled on next page.
- 3. PCB terminal models also available with silver contacts change "1" or "2" to "5" or "6" respectively, (ie LA1K-2C2V③ becomes LA1K-2C6V③).

Switches & Pilot Lights

Display Lights

Relays & Sockets

Timers



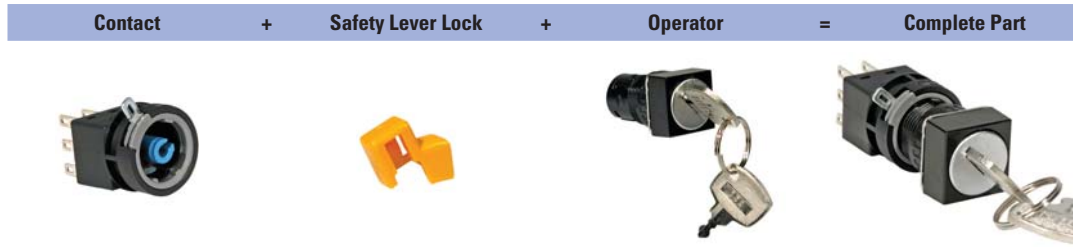

Terminal Blocks

Circuit Breakers

**Selector Switches (Sub-Assembled)**



**Operators**

Style	Position	Function	Part Number
Round 	2	Maintained Spring from right	LA1K-2Ⓞ LA1K-21B
	3	Maintained Spring from right Spring from left Spring from both	LA1K-3Ⓞ LA1K-31Ⓞ LA1K-32Ⓞ LA1K-33D
Square 	2	Maintained Spring from right	LA2K-2Ⓞ LA2K-21B
	3	Maintained Spring from right Spring from left Spring from both	LA2K-3Ⓞ LA2K-31Ⓞ LA2K-32Ⓞ LA2K-33D
Rectangular 	2	Maintained Spring from right	LA3K-2Ⓞ LA3K-21B
	3	Maintained Spring from right Spring from left Spring from both	LA3K-3Ⓞ LA3K-31Ⓞ LA3K-32Ⓞ LA3K-33D
Oversize Round 	2	Maintained Spring from right	HA1K-2Ⓞ HA1K-21B
	3	Maintained Spring from right Spring from left Spring from both	HA1K-3Ⓞ HA1K-31Ⓞ HA1K-32Ⓞ HA1K-33D

**Contacts**

Appearance	Contacts	Terminal Style	
		Solder Tab	PCB
 Gold	SPDT DPDT	HA-C1 HA-C2	HA-C1V HA-C2V
	SPDT DPDT	HA-C5 HA-C6	HA-C5V HA-C6V

-  1. All assembled switches listed on previous page use DPDT contacts.
- 2. SPDT Contacts for use on 2 position selector switch only

**Safety Lever Lock**

Appearance	Part Number
	HA9Z-LS

**Ⓞ Key Retention Option Codes**

Code	Description
A	Key not retained in any position (removable in all positions)
B	Key retained in right position only
C	Key retained in left position only
D	Key retained in left and right (3 position only)
E	Key retained in center only (3 position only)
G	Key retained right and center (3 position only)
H	Key retained left and center (3 position only)

-  Key cannot be removed from a spring-return position.

-  1. In place of Ⓞ specify key removable code from table on right.
- 2. Operator includes two keys.

Switches & Pilot Lights  
Display Lights  
Relays & Sockets  
Timers  
Terminal Blocks  
Circuit Breakers

Illuminated Selector Switches (Assembled)

Illuminated Selector Switches

Style	Position	Contact	Terminal Style		
			Solder Tab	PCB	
Round 	90° 2-Position	Maintained 	DPDT	LA1F-2C6③-②	LA1F-2C2③V-②
		Spring return from right 	DPDT	LA1F-21C6③-②	LA1F-21C2③V-②
	45° 3-Position	Maintained 	DPDT	LA1F-3C6③-②	LA1F-3C2③V-②
		Spring return from right 	DPDT	LA1F-31C6③-②	LA1F-31C2③V-②
		Spring return from left 	DPDT	LA1F-32C6③-②	LA1F-32C2③V-②
		2-Way spring return 	DPDT	LA1F-33C6③-②	LA1F-33C2③V-②
Square 	90° 2-Position	Maintained 	DPDT	LA2F-2C6③-②	LA2F-2C2③V-②
		Spring return from right 	DPDT	LA2F-21C6③-②	LA2F-21C2③V-②
	45° 3-Position	Maintained 	DPDT	LA2F-3C6③-②	LA2F-3C2③V-②
		Spring return from right 	DPDT	LA2F-31C6③-②	LA2F-31C2③V-②
		Spring return from left 	DPDT	LA2F-32C6③-②	LA2F-32C2③V-②
		2-Way spring return 	DPDT	LA2F-33C6③-②	LA2F-33C2③V-②
Rectangular 	90° 2-Position	Maintained 	DPDT	LA3F-2C6③-②	LA3F-2C2③V-②
		Spring return from right 	DPDT	LA3F-21C6③-②	LA3F-21C2③V-②
	45° 3-Position	Maintained 	DPDT	LA3F-3C6③-②	LA3F-3C2③V-②
		Spring return from right 	DPDT	LA3F-31C6③-②	LA3F-31C2③V-②
		Spring return from left 	DPDT	LA3F-32C6③-②	LA3F-32C2③V-②
		2-Way spring return 	DPDT	LA3F-33C6③-②	LA3F-33C2③V-②
Oversize Round 	90° 2-Position	Maintained 	DPDT	HA1F-2C6③-②	HA1F-2C2③V-②
		Spring return from right 	DPDT	HA1F-21C6③-②	HA1F-21C2③V-②
	45° 3-Position	Maintained 	DPDT	HA1F-3C6③-②	HA1F-3C2③V-②
		Spring return from right 	DPDT	HA1F-31C6③-②	HA1F-31C2③V-②
		Spring return from left 	DPDT	HA1F-32C6③-②	HA1F-32C2③V-②
		2-Way spring return 	DPDT	HA1F-33C6③-②	HA1F-33C2③V-②

Contact Operations

(for all selectors)

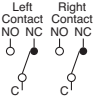
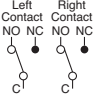
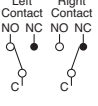
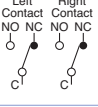
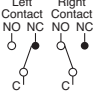
Contacts	Operator Position and Contact Operation	
2-pos. (DPDT)	Left	
	Right	
3-pos. (DPDT)	Left	
	Center	
	Right	

 As viewed from front of switch.

② Lens/LED Color Codes

Color	Code	Color	Code
Amber	A	Blue	S
Green	G	Yellow	Y
Red	R	White	W

③ Voltage/Lamp Code

Voltage	Code
5V DC LED	1
6V AC/DC LED	2
12V AC/DC LED	3
24V AC/DC LED	4
120V AC LED	8
6V AC/DC Incandescent	5
12V AC/DC Incandescent	6
24V AC/DC Incandescent	7

-  1. In place of ② specify Lens/LED Color Code from table above.  
 2. In place of ③ specify Voltage Code from table above.  
 3. Lamps also available in 5V DC, 6V AC/DC, 12 V AC/DC or 120V AC, change "4" or "7" using voltage/lamp codes (ie LA1F-2C6③-② uses 12V AC/DC LED).  
 4. All switches listed have DPDT contacts. For SPDT see sub-assembled on next page.  
 5. PCB terminal models also available with silver contacts change "1" or "2" to "5" or "6" respectively, (ie LA1F-2C24V-② becomes LA1F-2C64V-②).  
 6. Light independent of switch position.

Switches & Pilot Lights

Display Lights

Relays & Sockets

Timers

Terminal Blocks

Circuit Breakers



**Illuminated Selector Switches (Sub-Assembled)**



**Operators**

	Style	Position	Function	Part Number
Round		2	Maintained Spring from right	LA1F-20 LA1F-210
		3	Maintained Spring from right	LA1F-30 LA1F-310
			Maintained Spring from left Spring from both	LA1F-320 LA1F-330
Square		2	Maintained Spring from right	LA2F-20 LA2F-210
		3	Maintained Spring from right	LA2F-30 LA2F-310
			Maintained Spring from left Spring from both	LA2F-320 LA2F-330
Rectangular		2	Maintained Spring from right	LA3F-20 LA3F-210
		3	Maintained Spring from right	LA3F-30 LA3F-310
			Maintained Spring from left Spring from both	LA3F-320 LA3F-330
Oversize Round		2	Maintained Spring from right	HA1F-20 HA1F-210
		3	Maintained Spring from right	HA1F-30 HA1F-310
			Maintained Spring from left Spring from both	HA1F-320 HA1F-330

**Safety Lever Lock**

Appearance	Part Number
	HA9Z-LS

**Lamp Holder**

Appearance	Part Number
	HA9Z-AH

**Lamps**

Style	Voltage	Part Number
LED 	5V DC	LFTD-5Ⓞ
	6V AC/DC	LFTD-6Ⓞ
	12V AC/DC	LFTD-1Ⓞ
	24V AC/DC	LFTD-2Ⓞ
	120V AC	LFTD-H2Ⓞ
Incandescent 	6V AC/DC	LH-06
	12V AC/DC	LH-14
	24V AC/DC	LH-28

In place of Ⓞ specify LED color code from table below.

**Contacts**

Appearance	Contacts	Terminal Style	
		Solder Tab	PCB
	Gold SPDT DPDT	HA-C10	HA-C10V
		HA-C20	HA-C20V
	Silver SPDT DPDT	HA-C50	HA-C50V
		HA-C60	HA-C60V

All assembled selectors on previous pages use DPDT contacts. SPDT contacts are for use only on two position selectors.

**Lenses/Handles**

Appearance	Part Number
Standard 	LA1A-F-Ⓞ
Oversize 	HA1A-F-Ⓞ

In place of Ⓞ specify lens color code from table.

**Ⓞ Lens/LED Color Codes**

Color	Code
Amber	A
Green	G
Red	R
Blue	S
Yellow	Y
White	W

Switches & Pilot Lights

Display Lights

Relays & Sockets

Timers

Terminal Blocks

Circuit Breakers

### Pushbutton Selectors (Assembled)

#### Pushbutton Selectors

Style	Terminal Style	
	Solder Tab	PCB
	2 Position	HA1R-2C6-Ⓞ HA1R-2C2V-Ⓞ
	3 Position	HA1R-3C6-Ⓞ HA1R-3C2V-Ⓞ

- 1. In place of Ⓞ specify Button Color Code.
- 2. PCB terminal models also available with silver contacts (change "1" or "2" to "5" or "6" respectively, ie HA1R-2C2V-Ⓞ becomes HA1R-2C6V-Ⓞ).
- 3. Pushed position, momentary only.

#### ① Button Color Codes

Color	Code	Color	Code
Amber	A	Blue	S
Green	G	Yellow	Y
Red	R	White	W

#### Contact Operation

Style	Operator Position					
	Left		Center		Right	
	Normal	Pushed	Normal	Pushed	Normal	Pushed
2 Position			—	—		
3 Position				Blocked		

#### Contact Operation

Contacts	Operator Position and Contact Information	Down		Center	Up		
		Left Contact	Right Contact	Left Contact	Right Contact	Left Contact	Right Contact
2-pos. (DPDT)	Maintained Spring from Top			—			
2-pos. (DPDT)	Spring Return from Bottom			—			
3-pos. (DPDT)	All models						

As viewed from front of switch.

#### Lever Switches

Style	Operation	Contacts	Terminal Type	
			Solder Tab	PCB
	Maintained	DPDT	LA1T-2C6	LA1T-2C2V
	Spring return from top	DPDT	LA1T-21C6	LA1T-21C2V
	Spring return from bottom	DPDT	LA1T-22C6	LA1T-22C2V
	Maintained	DPDT	LA1T-3C6	LA1T-3C2V
	Spring return from top	DPDT	LA1T-31C6	LA1T-31C2V
	Spring return from bottom	DPDT	LA1T-32C6	LA1T-32C2V
	Spring return from both	DPDT	LA1T-33C6	LA1T-33C2V

- 1. PCB terminal models also available with silver contacts (change "1" or "2" to "5" or "6" respectively, ie LA1T-2C2V becomes LA1T-2C6V).
- 2. Terminology: U = up, D = down, C = center.

Switches & Pilot Lights

Display Lights

Relays & Sockets

Timers

Terminal Blocks

Circuit Breakers

**Switch Engraving Order Form – L6 Series**

Copy this order form and use it to specify Letter Height, Maximum Number of Lines and Text to be engraved.

To insure engraving accuracy, fax it to your IDEC representative or Distributor.

Your Company: \_\_\_\_\_  
 Name: \_\_\_\_\_  
 Address: \_\_\_\_\_  
 PO: \_\_\_\_\_

Telephone: \_\_\_\_\_  
 Fax: \_\_\_\_\_  
 Email: \_\_\_\_\_  
 Part Number to be Engraved: \_\_\_\_\_

Please check one of the boxes below to indicate your choice of engraving options:



	# of Lines	Letter Height	Max. Characters Per Line
<input type="checkbox"/>	1	5/32	6
<input type="checkbox"/>	2	5/32	6
<input type="checkbox"/>		1/8	6
<input type="checkbox"/>	3	1/8	6
<input type="checkbox"/>	4	N/A	

	# of Lines	Letter Height	Max. Characters Per Line
<input type="checkbox"/>	1	5/32	5
<input type="checkbox"/>	2	5/32	5
<input type="checkbox"/>		1/8	6
<input type="checkbox"/>	3	1/8	6
<input type="checkbox"/>	4	N/A	

	# of Lines	Letter Height	Max. Characters Per Line
<input type="checkbox"/>	1	5/32	3
<input type="checkbox"/>		1/8	3
<input type="checkbox"/>	2	Custom*	
<input type="checkbox"/>	3	Custom*	
<input type="checkbox"/>	4	N/A	

\*Engraving is possible, but character size will be smaller than standard sizes.



- Above mentioned specifications hold true for standard size pushbuttons (round, square and rectangular).
- Oversize pushbuttons and pilot lights allow you to engrave 1 additional character.
- Engraving is done on the button itself for non-illuminated push buttons and on marking plate for illuminated pushbuttons and pilot lights.
- Please enter text exactly how you want it engraved, take care to emphasize capital or small letters.

Enter text to be engraved:

Line 1: \_\_\_\_\_  
 Line 2: \_\_\_\_\_  
 Line 3: \_\_\_\_\_  
 Line 4: \_\_\_\_\_

**Sample Letter Sizes**

1/8 Letters: **OPEN**

5/32 Letters: **OPEN**

For IDEC Internal Use Only:

Work Order #: \_\_\_\_\_

## Accessories

Part		Specifications	Part Number	Notes	
Ring Wrench		Made of metal	MT-001	Used for tightening the plastic locking ring when installing the L6 series unit on a panel. Tightening torque should not exceed 9kgf cm when tightening the locking ring.	
Lamp Holder Tool (Made of Rubber)		Made of rubber. Used for removing and replacing LED and incandescent lamps in illuminated units.	OR-44	Rubber tool used for replacing LED and incandescent lamps.	
Lens Removal Tool		For illuminated pushbuttons and pilot lights.	MT-101	Used for removing the lens or button from the housing.	
LED Lamp		5V DC 6V AC/DC 12V AC/DC 24V AC/DC 120V AC	LFTD-5Ⓢ LFTD-6Ⓢ LFTD-1Ⓢ LFTD-2Ⓢ LFTD-H2Ⓢ	T 1-3/4 miniature flange base. In place of Ⓢ specify LED Color Code (A, G, R, S, W, Y).	
Incandescent Lamp		6V AC/DC 12V AC/DC 24V AC/DC	LH-06 LH-14 LH-28	0.5W, T 1-3/4 miniature flange base	
Switch Guard		90 degrees opening maintained	Round/Square Rectangular	AL-K6 AL-KH6	Prevents inadvertent switch operation. IP40 dust-tight rated.
		180 degrees opening, spring return	Round/Square Rectangular	AL-K6SP AL-KH6SP	
			For round units	Rectangular	HA9Z-K1
		For square units	Oversize Round/Sq		
Dust-proof Cover		For round units		AL-D6	Provides extra level of sealing for "front-panel" portion of switches. (Not applicable for units with oversize lenses or buttons).
		For square units		AL-DQ6	
		For rectangular units		AL-DH6	
Terminal Cover		Made of white nylon	All removable contacts	H6-VL2	Covers terminals to prevent possible electric shock.
			Unibody Pilot Lights	H6-PVL	
Mounting Hole Plug		Rubber		AL-B6	Fills unused panel cutouts. Made of nitrile rubber. Push-in installation from front of panel. IP65 (oiltight) rated.
		Aluminum		AL-BM6	Fills unused panel cutouts. Made of aluminum. Screw-on locking ring from inside of panel. IP65 (oiltight) rated.
Replacement Keys		for LA1K, LA2K, LA3K (#132)		AS6-SK	Pair of keys.
		for HA1K (#231) – oversize		KG9Z-SK	
Replacement Engraving Inserts			Round Square Rectangle Oversize Round Oversize Square Mushroom	AL6M-W AL6Q-W AL6H-W HA9Z-P1-W HA9Z-P2-W HA9Z-P13-W	
Replacement Locking Ring		All models		HA9Z-LN	
Replacement Anti-Rotation Ring			L6 standard	AL6-LP	Prevents rotation of switches in panel. (included with all assembled switches)
			L6 oversize	HA9Z-LP	
Replacement Selector Inserts				HA9Z-HC1-Ⓢ	Applicable to round oversize selectors only Ⓢ = (G, R, S, W, Y)
Replacement Safety Lever Lock				HA9Z-LS	

Switches & Pilot Lights

Display Lights

Relays & Sockets

Timers

Terminal Blocks

Circuit Breakers

Appearance	Description	Used With	Part Number
	ø24mm round, metal (aluminum color), panel cut-out ø20.2mm	L6 Switch + Flush Bezel = Flush Switch	LA9Z-SM61
	ø24mm round, plastic (black), panel cut-out ø20.2mm		LA9Z-S61B
	□24mm square, plastic (black), panel cut-out □20.2mm		LA9Z-S71B
	24 x 30mm rectangular, plastic (black), panel cut-out ø20.2 x 26.2mm		LA9Z-S81B
	Rectangular, plastic (black)		LA9Z-KS8

Flush bezels not applicable for oversize units.

**Dimensions (mm)**

**Pilot Lights (LA\*P,) Pushbuttons (LA\*B)**

**Illuminated Pushbuttons (LA\*L)**

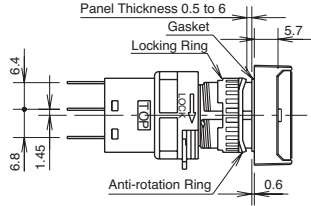
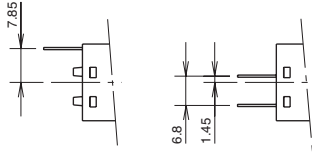

Note:  
 1. Pushbuttons do not have lamp terminals.  
 2. Pilot lights have only lamp terminals.

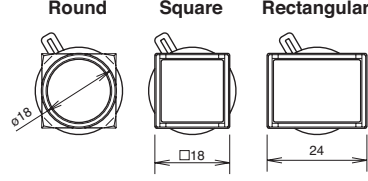
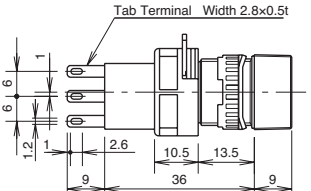
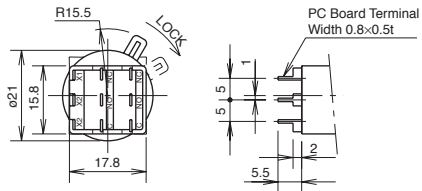

PC Board Terminal

Solder/Tab Terminal

**Lever Switches (LA1T)**

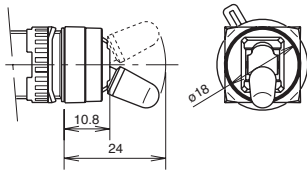

**Buzzer (LA3Z)**

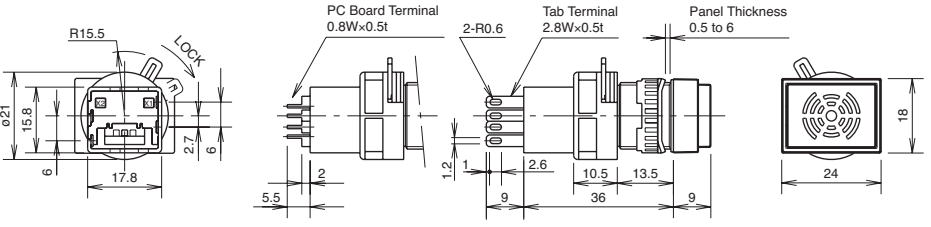

**Emergency Stop Switch (HA1B)**

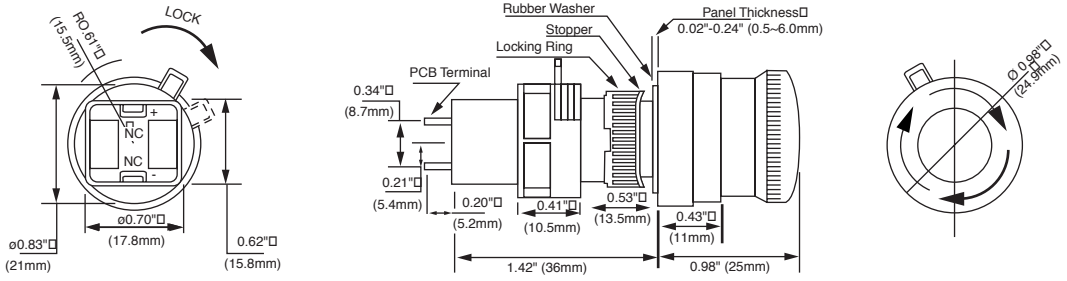



Emergency Stop Switch (HA1E) - Short Body Style

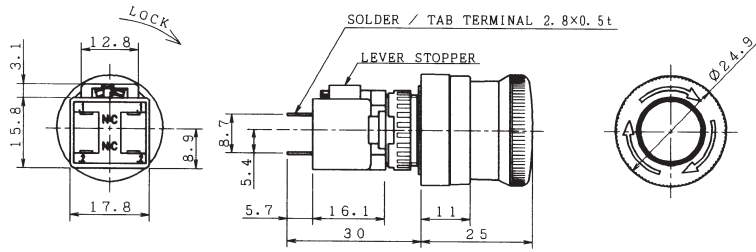

Selector Switches (LA\*S), Illuminated Selector Switches (LA\*F), Key Selector Switches (LA\*K)

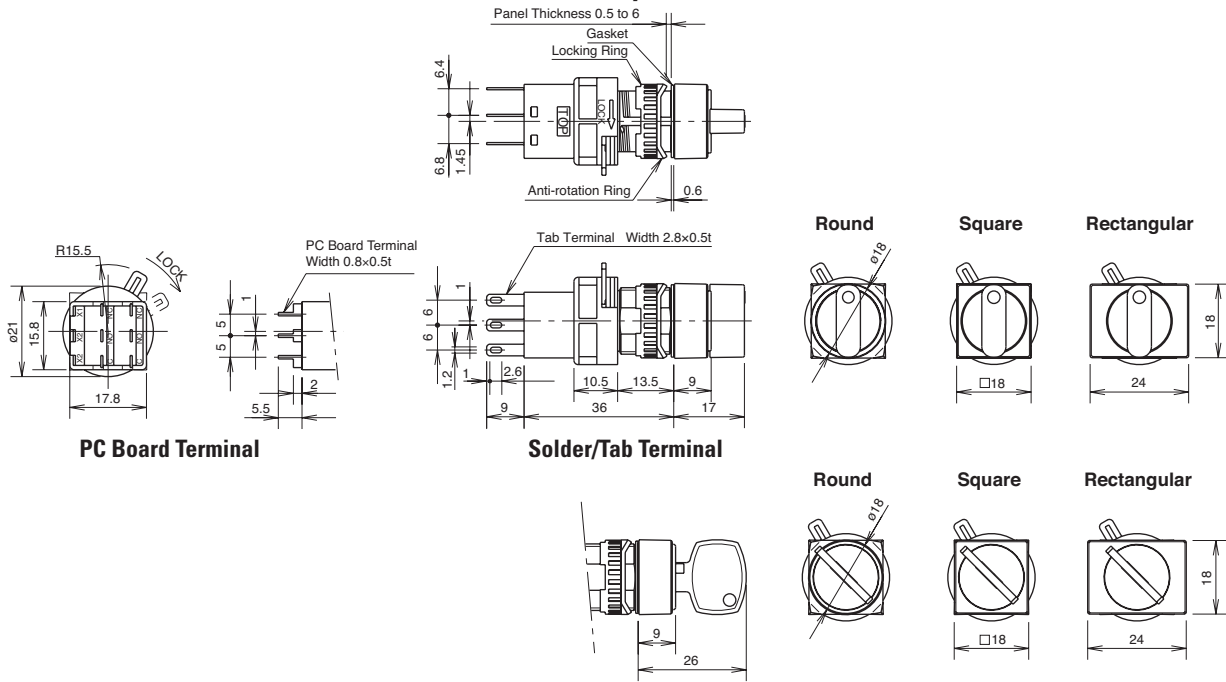

PC Board Drilling Layout (Bottom View)

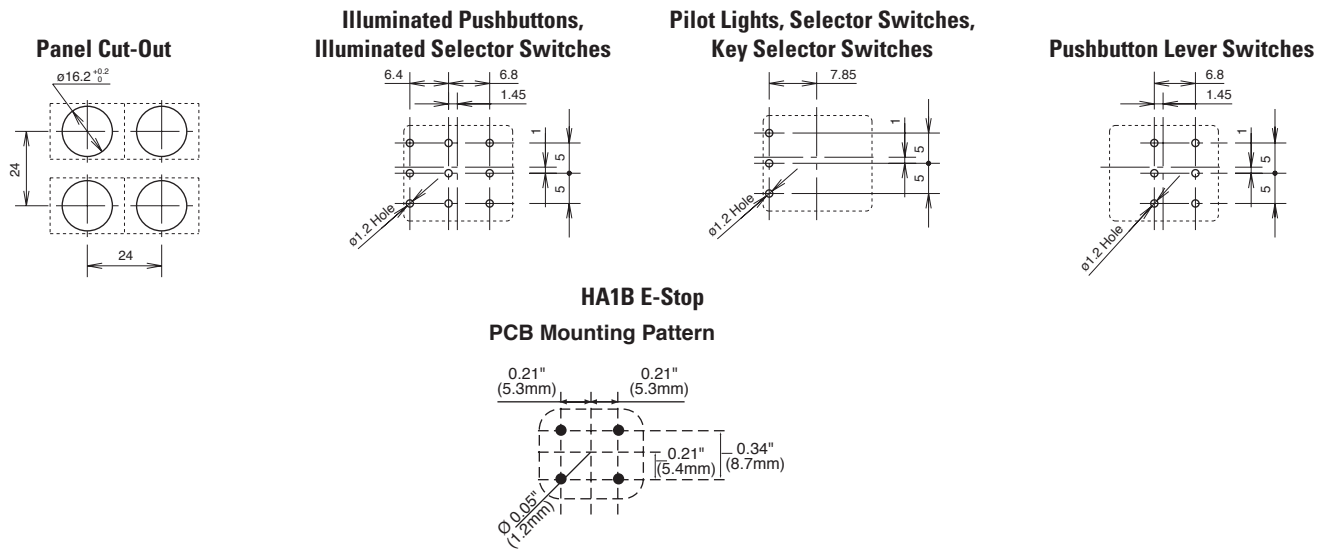

Switches & Pilot Lights

**Enlarge Flush Pushbutton and Pilot Lights**

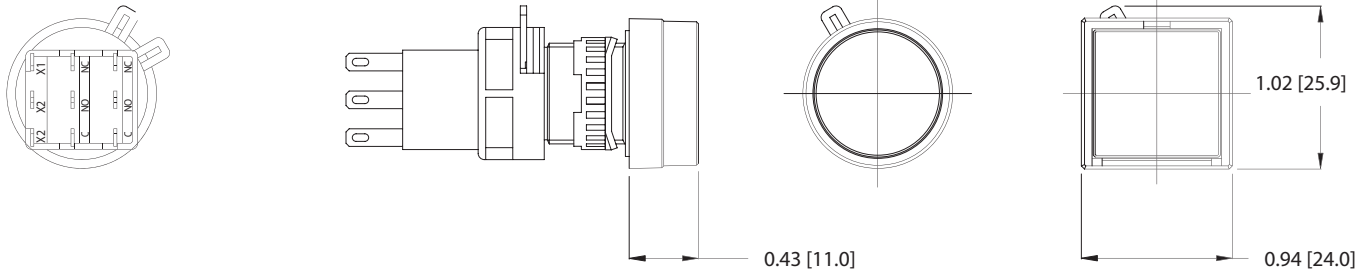

Display Lights

**Enlarge Extended Non-Illuminated Pushbutton**

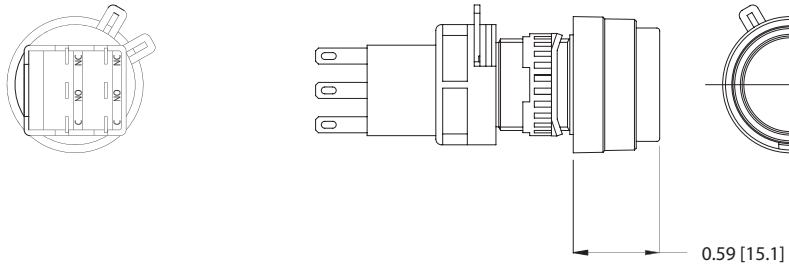

Relays & Sockets

**Enlarge Unibody Pilot Lights**

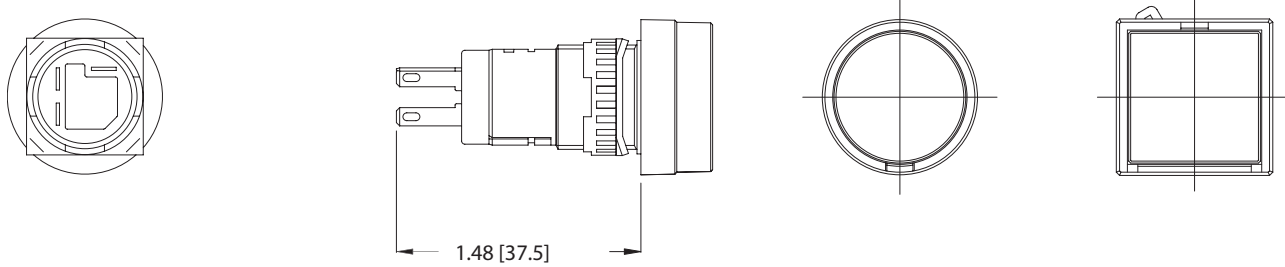

Timers

**Mushroom Pushbuttons**

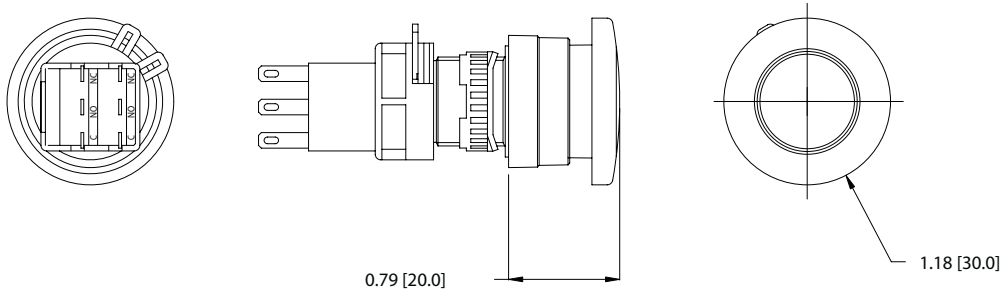

Terminal Blocks

**Enlarge Selector Switch**

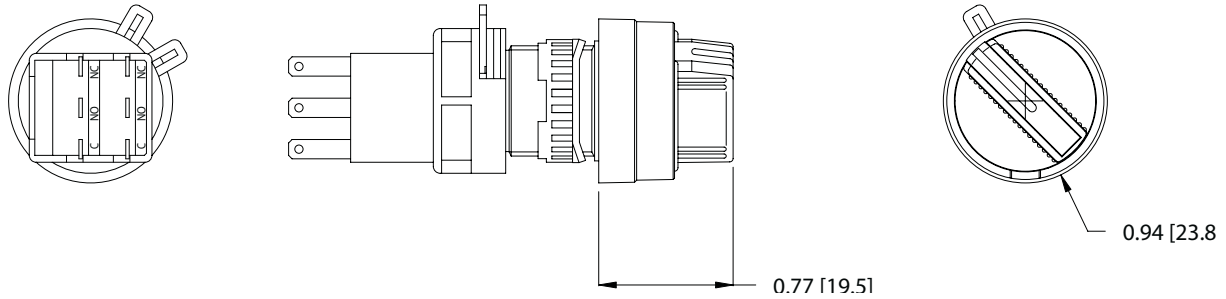

Circuit Breakers

**Oversize Key Switch**

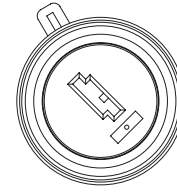
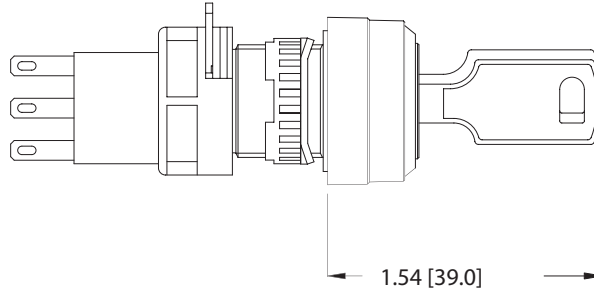
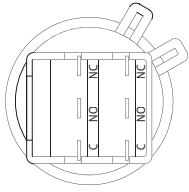

**Lever Switch**

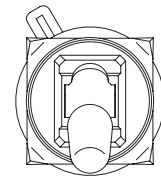
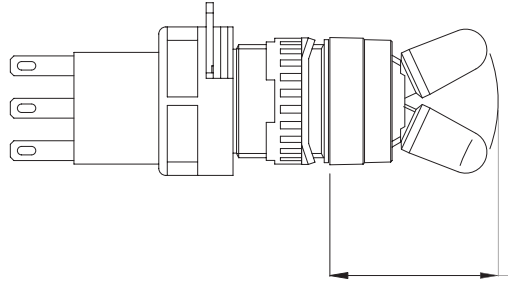
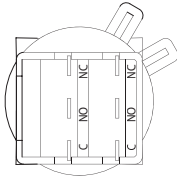

**Flush Bezel**

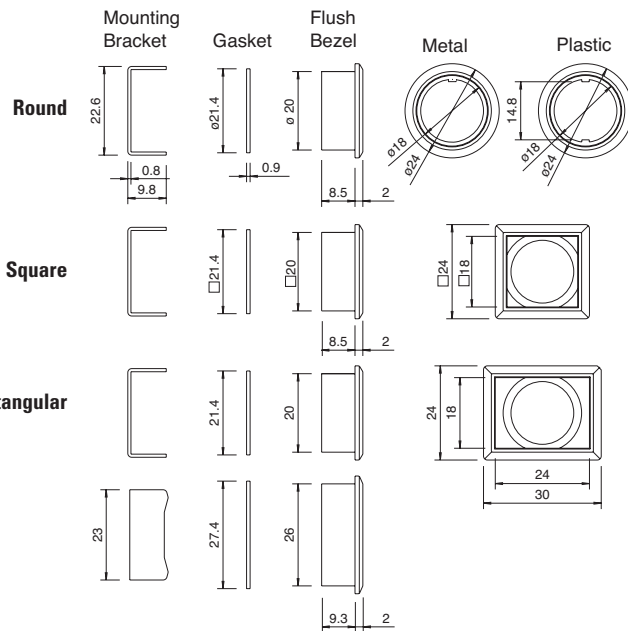

**Flush Bezel with Switch**

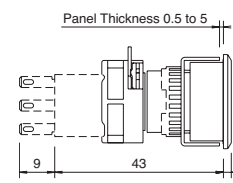

**Selector Switches**

**Illuminated & Non-illuminated**

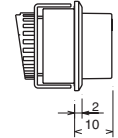

**Key**

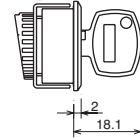

**Lever**

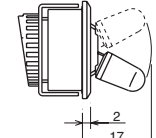

**Flush Bezel Mounting Hole Layout**

**Round**

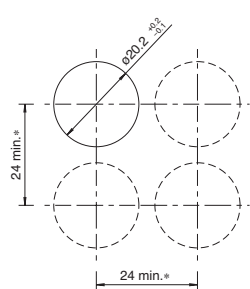

**Square**

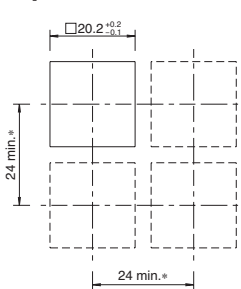

**Rectangular**

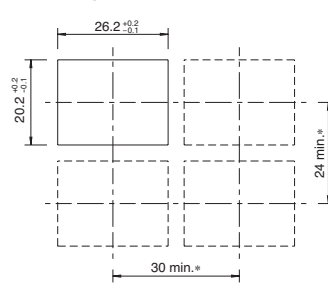

Switches & Pilot Lights

Display Lights

Relays & Sockets

Timers

Terminal Blocks

Circuit Breakers

**Terminal Configurations**  
**Non Illuminated Pushbutton**

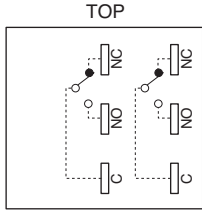

**Pilot Lights**

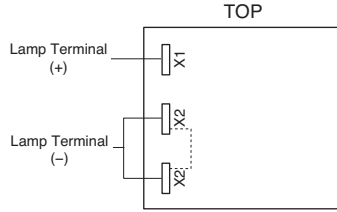

**AL-K6SP**  
**Illuminated Pushbuttons**

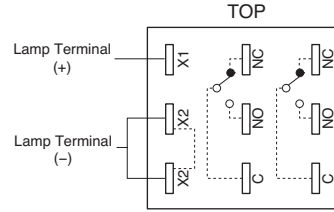

**Buzzer**

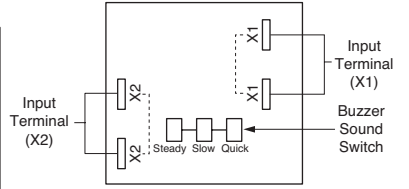

**AL-KH6SP**

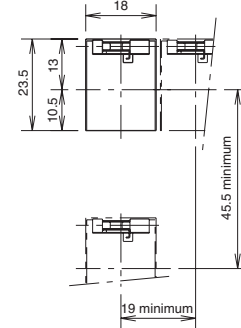
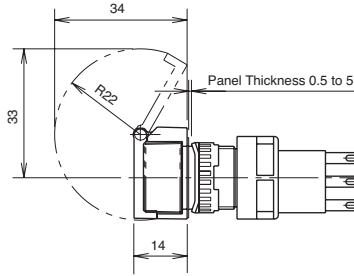
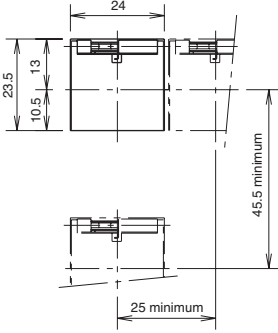

**AL-D6**

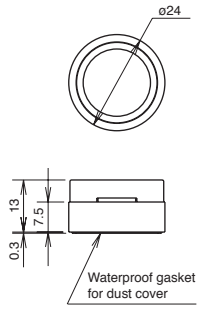

**AL-DQ6**

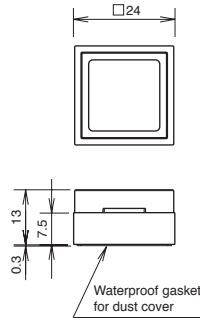

**AL-DH6**

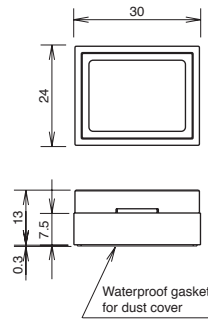

**H6-VL2**

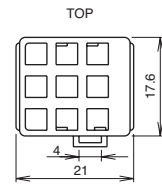
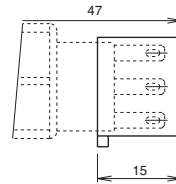

**AL-B6**

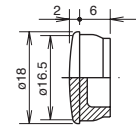

**AL-BM6**

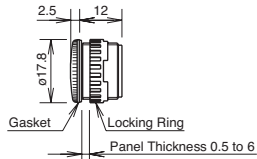

**LFTD**

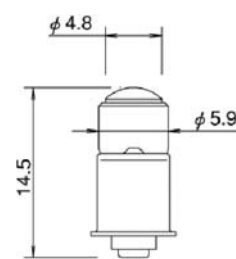

**LED Lamp Internal Circuit**

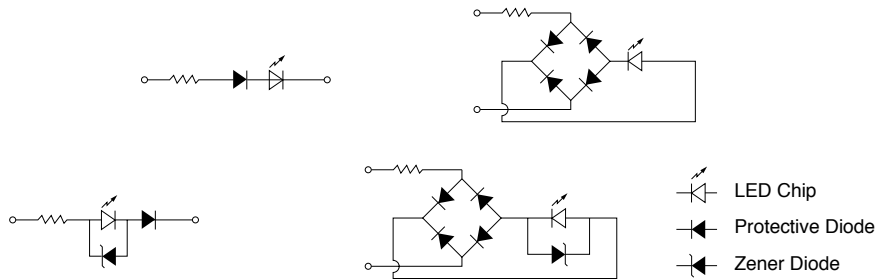

**AL-B6**

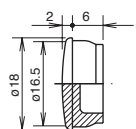

## General Instructions

### Pushbutton Assembly

#### Lamp Installation

Lamps can be replaced in two ways:

1. If contacts are accessible (or pushbutton not installed in a panel) then it is easiest to first remove the contacts from the operator. This will allow easy access to the lamp/lamp-holder assembly. Grab lamp, depress slightly, and turn counter clockwise. Lamp can then be removed by pushing it back through the lamp holder.
2. If contacts are not accessible, then the lamp can be replaced by first removing the lens from the operator. Just pull lens straight out either with a fingernail or optional lens removal tool (MT-101). Lamp/lamp-holder assembly can then be removed with lamp removal tool (OR-44). Insert lamp removal tool through operator, depress slightly, turn counter clockwise, then pull lamp/lamp-holder assembly out. Lamp can then be removed by pushing it back through the lamp holder.

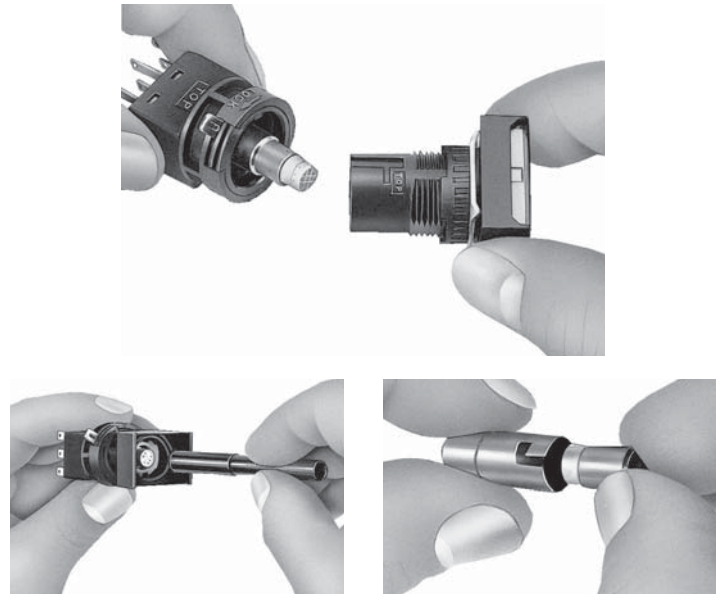

#### Engraving Lenses

All buttons and lenses can be engraved directly on the outside surface. Illuminated lenses also allow for engraving on a plate that is underneath the colored section of the lens. Remove the colored section of the lens by pulling on the edge while simultaneously unhooking it from the latches on the lens holder. The marking plate will then be accessible. It can then be engraved or a thin marked insert (such as mylar or paper) can be sandwiched between the marking plate and colored section of the lens.

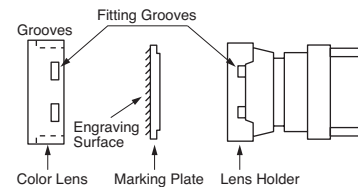

#### Panel Mounting

Before any unit can be mounted into a panel, the contact block must be removed. Slide metal locking lever and pull contact off. Loosen and remove the locking ring and square anti-rotation ring from the operator and insert operator through panel cutout from the front of the panel. Slide on anti-rotation ring and tighten locking ring, using locking ring wrench (MT-001). Slide contact block onto operator, observing TOP marking on both parts. Slide metal locking lever in direction indicated by LOCK. The yellow plastic safety lever lock can then be snapped onto the locking lever; this will prevent vibration or maintenance actions from releasing the contact from the operator.

#### PCB Mounting

Being able to separate the contacts from the operator allows for assembly of the front panel components (operator and lens) to be performed in tandem with the PC board assembly and soldering. For applications where multiple rows of push-buttons are mounted closely together, or where other components may obstruct access to the contact locking lever, be sure to include access holes in the PC board (refer to PC board layout dimensions for location). Also be sure to allow for space above and to the side of contact to ensure that no components block the contact block locking lever. PC board pins are designed to rest on the PCB, take this into consideration to ensure that pins do not short closely spaced traces.

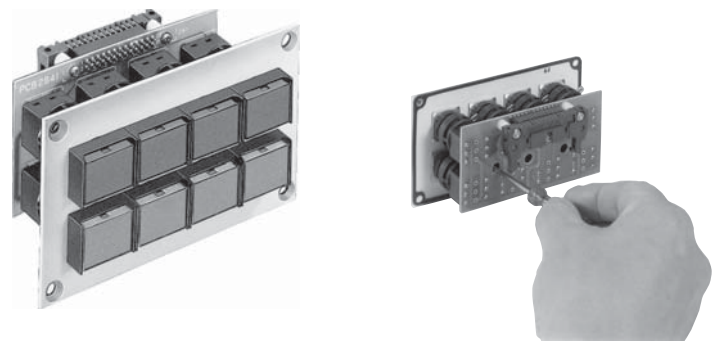



## X-ON Electronics

Largest Supplier of Electrical and Electronic Components

*Click to view similar products for [Emergency Stop Switches / E-Stop Switches](#) category:*

*Click to view products by [Idec](#) manufacturer:*

Other Similar products are found below :

[84-6830.0020](#) [AVN302N-R](#) [3050.1302Y](#) [44-710](#) [84-6841.2B20](#) [ZA2BV05](#) [951FY000-WO](#) [ER6022-022N](#) [952+2000-00](#) [ES3S51653001](#)  
[601+0000-OP](#) [E100-A2A22S05A](#) [XCSEA802](#) [XCSB502](#) [2TLA030051R0100](#) [D2D 1009M](#) [D2D 1013H](#) [AZM 170SK-02ZRKA 24VAC/DC](#)  
[84-6820.0020A](#) [84-6820.0040](#) [XY2CH13250H29](#) [XCSDMR590L01M12](#) [XCSTA892](#) [XCSMP80L5](#) [FB1W-HW1B-M220B](#) [FB1W-HW1B-](#)  
[X401R](#) [84-5221.2B20](#) [AZM KEY \(M5\)](#) [AZ 17/170-B15](#) [AZM 161SK-12/12RKA-110/230](#) [AZM 415-11/11ZPK 24VAC/DC](#) [AZM 415-](#)  
[11/11ZPKA 24VAC/DC](#) [AZM 161-B1S](#) [AZ 15/16-B1-2245](#) [AZ 17/170-B11](#) [AZ 17-11ZI B5](#) [BNS 40S-12Z 10,0M](#) [AZ 16-02ZVRK-ST](#)  
[AZ/AZM 415-B2](#) [AZ/AZM 415-B3](#) [MZM 100-B1.1](#) [A-K8P-M12-S-G-5M-BK-2-X-A-4-69](#) [A-K8P-M12-S-G-10M-BK-2-X-A-4-69](#) [A-K5P-](#)  
[M12-S-G-10M-BK-2-X-A-4-69](#) [A-K4P-M12-S-G-2M-BK-2-X-A-4-69](#) [AZ/AZM201-B30-RTAG1P1-SZ](#) [SK-BETÄTIGER M3](#) [SK-BET.M4](#)  
[KPL. M.KAP.](#) [BETÄTIGER A1 KPL.](#) [SKT-U1Z M3](#)