

















Ø16mm H6 Series Miniature Control Units















ø16 H6 Series Miniature Control Units

Series		H6 Series Miniature Control Units			
Mounting Hole Size		ø16 mm			
Type	HA□L	HA1L-□3	HA□P	HA□B-#1	
Appearance			Separate Type  Unibody Type 		
Unit	Illuminated Pushbuttons (Momentary, Maintained)	Mushroom Illuminated Pushbuttons (Momentary, Maintained)	Pilot Lights (Separate type, Unibody type)	Flush Pushbuttons (Momentary, Maintained)	
Bezel Size (Operator Size)	  	 ø30mm Button	  		
Bezel Color	Black				
Light Source	LED lamp (IDEC's LFTD Type)			—	
Lens/Button Color	Lens Color: Amber, Blue, Green, Red, Yellow, White			Button Color: Black, Blue, Green, Red, Yellow, White	
Contact	Contact Configuration	SPDT, DPDT (gold-clad silver, silver)	—	SPDT, DPDT (gold-clad silver, silver)	
	Contact Rating (resistive load)	Gold-clad silver contacts: 125V AC · 0.1A, 30V DC · 0.1A Silver contacts: 125V AC · 3A, 30V DC · 2A	—	Gold-clad silver contacts: 125V AC · 0.1A, 30VDC · 0.1A Silver contacts: 125V AC · 3A, 30VDC · 2A	
Durability	Electrical	100,000 operations minimum	—	100,000 operations minimum	
	Mechanical	Momentary: 1,000,000 operations minimum Maintained: 200,000 operations minimum	—	Momentary: 1,000,000 operations minimum Maintained: 200,000 operations minimum	
Degree of Protection	IP65 (IEC 60529)				
Terminal Style	Solder/Tab terminal #110 PCB Terminal (gold contact only)				
Accessories	Switch Guard	Yes	—	—	Yes
	Terminal Cover	Yes	Yes	Yes	Yes
	Mounting Hole Plug	Yes			
Remarks	<ul style="list-style-type: none"> Separate contact block mount can be removed from the operator. Large operators for easy operation; bezel size ø24mm or 24 × 24 mm Shock- and vibration-resistant rugged design, waterproof and dust-tight 				
Approvals	   				
See Page	6	7	9	11	

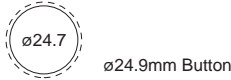
Note: Specify a bezel code in place of □ in the Type No.

H6 Series Miniature Control Units Ø16

Series		H6 Series Miniature Control Units			
Mounting Hole Size		Ø16 mm			
Type		HA□B-#2	HA1B-#3	HA1B-V2E	HA1E-V2S
Appearance				Direct Opening Action  	Direct Opening Action   Short Body Type
Unit		Extended Pushbuttons (Momentary, Maintained)	Mushroom Pushbuttons (Momentary, Maintained)	Pushlock Turn Reset Emergency Stop Switch	Pushlock Turn Reset Emergency Stop Switch
Bezel Size (Operator Size)					
Bezel Color		Black			
Light Source		—			
Lens/Button Color		Button Color: Black, Blue, Green, Red, Yellow, White		Button Color: Red only	Button Color: Red only
Contact	Contact Configuration	SPDT, DPDT (gold-clad silver, silver)		1NC, 2NC (silver)	1NC, 2NC (silver)
	Contact Ratings (resistive load)	Gold-clad silver contacts: 125V AC · 0.1A, 30V DC · 0.1A Silver contacts: 125V AC · 3A, 30V DC · 2A		250V AC · 1.5A 125VDC · 0.22A	250V AC · 1.5A 125VDC · 0.22A
Durability	Electrical	100,000 operations minimum		100,000 operations minimum	100,000 operations minimum
	Mechanical	Momentary: 1,000,000 operations minimum Maintained: 200,000 operations minimum		250,000 operations minimum	250,000 operations minimum
Degree of Protection		IP65 (IEC 60529)			
Terminal Style		Solder/Tab terminal #110 PCB Terminal (gold contacts only)		Solder/Tab terminal #110 PCB Terminal	Solder Terminal PCB Terminal
Accessory	Terminal Cover	Yes		Yes	Yes
	Mounting Hole Plug	Yes		Yes	Yes
Remarks		<ul style="list-style-type: none"> Separate contact block can be removed from the operator. Large operators for easy operation Shock- and vibration-resistant rugged design, water-proof 		<ul style="list-style-type: none"> Direct opening action Safety lock mechanism 	
Approvals					
See Page		12	12	27	27

Note: Specify a bezel code in place of □ in the Type No.

ø16 H6 Series Miniature Control Units

Series		H6 Series Miniature Control Units			
Mounting Hole Size		ø16 mm			
Type		HA1S / HA3S	HA1K / HA3K	HA1F / HA3F	HA1R
Appearance					
Unit		Selector Switches 2-position maintained 2-position spring-return 3-position maintained 3-position spring-return	Key Selector Switches 2-position maintained 2-position spring-return 3-position maintained 3-position spring-return	Illuminated Selector Switches 2-position maintained 2-position spring-return 3-position maintained 3-position spring-return	Selector Pushbuttons 2-position 3-position
Bezel Size (Operator Size)		 			
Bezel Color		Black			
Light Source		—	—	LED lamp (IDEC's LFTD Type)	—
Lens/Button Color		Knob Color: Black Color Insert: White	Key Cylinder: Black (plastic)	Illumination Color: Amber, Blue, Green, Red, Yellow, White	Button Color: Black, Blue, Green, Red, Yellow
Contact	Contact Configuration	SPDT, DPDT (gold-clad silver, silver)			
	Contact Ratings (resistive load)	Gold-clad silver contacts: 125V AC · 0.1A, 30V DC · 0.1A Silver contacts: 125V AC · 3A, 30V DC · 2A			
Durability	Electrical	100,000 operations minimum			
	Mechanical	250,000 operations minimum			
Degree of Protection		IP65 (IEC 60529)			
Terminal Style		Solder/Tab terminal #110 PCB Terminal (gold contacts only)			
Accessory	Terminal Cover	Yes			
	Mounting Hole Plug	Yes			
Remarks		<ul style="list-style-type: none"> Separate contact block can be removed from the operator. Large operators for easy operation; bezel size ø24mm or 24 × 24 mm Shock- and vibration-resistant rugged design, waterproof 			
Approvals		   			
See Page		14	16 and 17	19 and 20	22

ø16 H6 Series Miniature Control Units

Designed to ensure ease of operation and safety
Ideal for heavy duty applications such as machine tools

- Separate contact block makes installation and removal easy.
- Large operators; bezel size (ø24 mm, 24×24 mm)
- High operating force and long stroke prevent inadvertent operation.
- Contact blocks can be removed when units are mounted collectively.
- Shock- and vibration-resistant rugged design
- IP65
- UL recognized, CSA certified
- EN compliant (EN 60947-1, EN 60947-5-1, TÜV approved)



Emergency stop switches are DEMKO-approved.



Contact Ratings

Except for emergency stop switches (see page 27).

• Gold Contact

Rated Insulation Voltage	250V	
Rated Thermal Current	3A	
Rated Operating Voltage	125V AC	30V DC
Rated Operating Current (resistive load)	0.1A	0.1A
Contact Material	Gold-clad silver	

Minimum applicable load (reference value): 5V AC/DC, 1 mA
 (Applicable range is subject to the operating condition and load.)

• Silver Contact

Rated Insulation Voltage	250V				
Rated Thermal Current	5A				
Rated Operating Voltage	30V	125V	250V		
Rated Operating Current	AC 50/60 Hz	Resistive Load	—	3A	2A
		Inductive Load	—	2A	1.5A
	DC	Resistive Load	2A	0.4A	—
		Inductive Load	1A	0.2A	—
Contact Material	Silver				

AC inductive load: PF = 0.6 to 0.7, DC inductive load: L/R = 7 ms maximum

Built-in LED Lamp Ratings



Type No.	LFTD-5②	LFTD-1②	LFTD-2②
Lamp Base	SX6S/8×5.4		
Operating Voltage	5V DC±5%	12V AC/DC ±10%	24V AC/DC ±10%
Rated Voltage	5V DC	12V AC/DC	24V AC/DC
Current Draw	AC	—	9 mA
	DC	8 mA	8 mA
Color Code ②	Specify a color code in place of ② in the Type No. A (amber), G (green), R (red), S (blue), W (white), Y (yellow)		
Lamp Base Color	Same as illumination color		
Voltage Marking	Die stamped on the lamp base.		
Life (reference value)	Approx. 50,000 hours (When used on complete DC, luminance reduces to 50% of the initial intensity.)		
Internal Circuit	A, R, W, Y	A, R, W, Y	
	G, S	G, S	

Specifications

Operating Temperature	-25 to +55°C (no freezing)
Storage Temperature	-30 to +80°C
Operating Humidity	45 to 85% RH (no condensation)
Contact Resistance	50 mΩ maximum (initial value)
Insulation Resistance	100 MΩ minimum (500V DC megger)
Dielectric Strength	Switch Unit
	Illumination Unit
Between live part and ground: 2,500V, 1 minute	
Between terminals of different poles: 2,500V, 1 minute	
Between terminals of the same pole: 1,000V, 1 minute	
Between live part and ground: 2,500V, 1 minute	
Vibration Resistance	Operating extremes: 5 to 55 Hz, amplitude 0.5 mm
Shock Resistance	Operating extremes: 100 m/s ² (10G) Damage limits: 1,000 m/s ² (100G)
Mechanical Durability (minimum operations)	Momentary: 1,000,000
	Maintained: 200,000
	Selector switch: 250,000
	Key selector switch: 250,000
	Illuminated selector switch: 250,000
Selector pushbutton: 250,000	
Electrical Durability (minimum operations)	Momentary: 100,000 (at 1,800 operations/hour)
	Maintained: 100,000 (at 1,200 operations/hour)
	Selector switch: 100,000
Degree of Protection	IP65 (IEC 60529)
Terminal Style	Solder/tab terminal #110 PC board terminal
Weight (approx.)	HA1L-M1C24: 18g
	HA1P-1C04: 17g
	HA1P-14: 13g
	HA1B-M1C2: 16g
	HA1S-2C2: 18g
	HA1K-2C2A: 33g
HA1F-2C24: 20g	

ø16 H6 Series Miniature Control Units







HA1L/HA2L Illuminated Pushbuttons

Style	Operation	Contact Material	Operating Voltage	Contact	Type No.		② Lens Color Code	
					Solder/Tab Terminal	PC Board Terminal		
Round HA1L  UL ® △ CE	Momentary	Gold	5V DC ±5%	SPDT	HA1L-M1C11②	HA1L-M1C11V②		
				DPDT	HA1L-M1C21②	HA1L-M1C21V②		
			12V AC/DC ±10%	SPDT	HA1L-M1C13②	HA1L-M1C13V②		
				DPDT	HA1L-M1C23②	HA1L-M1C23V②		
			24V AC/DC ±10%	SPDT	HA1L-M1C14②	HA1L-M1C14V②		
				DPDT	HA1L-M1C24②	HA1L-M1C24V②		
		Silver	5V DC ±5%	SPDT	HA1L-M1C51②	—		
				DPDT	HA1L-M1C61②			
			12V AC/DC ±10%	SPDT	HA1L-M1C53②			
				DPDT	HA1L-M1C63②			
			24V AC/DC ±10%	SPDT	HA1L-M1C54②			
				DPDT	HA1L-M1C64②			
	Maintained	Gold	5V DC ±5%	SPDT	HA1L-A1C11②			HA1L-A1C11V②
				DPDT	HA1L-A1C21②			HA1L-A1C21V②
			12V AC/DC ±10%	SPDT	HA1L-A1C13②			HA1L-A1C13V②
				DPDT	HA1L-A1C23②			HA1L-A1C23V②
			24V AC/DC ±10%	SPDT	HA1L-A1C14②			HA1L-A1C14V②
				DPDT	HA1L-A1C24②			HA1L-A1C24V②
		Silver	5V DC ±5%	SPDT	HA1L-A1C51②	—		
				DPDT	HA1L-A1C61②			
			12V AC/DC ±10%	SPDT	HA1L-A1C53②			
				DPDT	HA1L-A1C63②			
			24V AC/DC ±10%	SPDT	HA1L-A1C54②			
				DPDT	HA1L-A1C64②			
Square HA2L  UL ® △ CE	Momentary	Gold	5V DC ±5%	SPDT	HA2L-M1C11②		HA2L-M1C11V②	
				DPDT	HA2L-M1C21②		HA2L-M1C21V②	
			12V AC/DC ±10%	SPDT	HA2L-M1C13②		HA2L-M1C13V②	
				DPDT	HA2L-M1C23②		HA2L-M1C23V②	
			24V AC/DC ±10%	SPDT	HA2L-M1C14②		HA2L-M1C14V②	
				DPDT	HA2L-M1C24②		HA2L-M1C24V②	
		Silver	5V DC ±5%	SPDT	HA2L-M1C51②	—		
				DPDT	HA2L-M1C61②			
			12V AC/DC ±10%	SPDT	HA2L-M1C53②			
				DPDT	HA2L-M1C63②			
			24V AC/DC ±10%	SPDT	HA2L-M1C54②			
				DPDT	HA2L-M1C64②			
	Maintained	Gold	5V DC ±5%	SPDT	HA2L-A1C11②		HA2L-A1C11V②	
				DPDT	HA2L-A1C21②		HA2L-A1C21V②	
			12V AC/DC ±10%	SPDT	HA2L-A1C13②		HA2L-A1C13V②	
				DPDT	HA2L-A1C23②		HA2L-A1C23V②	
			24V AC/DC ±10%	SPDT	HA2L-A1C14②		HA2L-A1C14V②	
				DPDT	HA2L-A1C24②		HA2L-A1C24V②	
		Silver	5V DC ±5%	SPDT	HA2L-A1C51②	—		
				DPDT	HA2L-A1C61②			
			12V AC/DC ±10%	SPDT	HA2L-A1C53②			
				DPDT	HA2L-A1C63②			
			24V AC/DC ±10%	SPDT	HA2L-A1C54②			
				DPDT	HA2L-A1C64②			

A: amber
G: green
R: red
S: blue
W: white
Y: yellow

Note: Specify a lens color code in place of ② in the Type No.
Package quantity: 1

HA3L/HA4L/HA1L-M3/A3 LED Illuminated Pushbuttons

Style	Operation	Contact Material	Operating Voltage	Contact	Type No.		② Lens Color Code	
					Solder/Tab Terminal	PC Board Terminal		
Round w/Square Bezel HA3L  	Momentary	Gold	5V DC ±5%	SPDT	HA3L-M1C11②	HA3L-M1C11V②		
				DPDT	HA3L-M1C21②	HA3L-M1C21V②		
			12V AC/DC ±10%	SPDT	HA3L-M1C13②	HA3L-M1C13V②		
				DPDT	HA3L-M1C23②	HA3L-M1C23V②		
			24V AC/DC ±10%	SPDT	HA3L-M1C14②	HA3L-M1C14V②		
				DPDT	HA3L-M1C24②	HA3L-M1C24V②		
		Silver	5V DC ±5%	SPDT	HA3L-M1C51②	—		
				DPDT	HA3L-M1C61②			
			12V AC/DC ±10%	SPDT	HA3L-M1C53②			
				DPDT	HA3L-M1C63②			
			24V AC/DC ±10%	SPDT	HA3L-M1C54②			
				DPDT	HA3L-M1C64②			
	Maintained	Gold	5V DC ±5%	SPDT	HA3L-A1C11②			HA3L-A1C11V②
				DPDT	HA3L-A1C21②			HA3L-A1C21V②
			12V AC/DC ±10%	SPDT	HA3L-A1C13②			HA3L-A1C13V②
				DPDT	HA3L-A1C23②			HA3L-A1C23V②
			24V AC/DC ±10%	SPDT	HA3L-A1C14②			HA3L-A1C14V②
				DPDT	HA3L-A1C24②			HA3L-A1C24V②
		Silver	5V DC ±5%	SPDT	HA3L-A1C51②	—		
				DPDT	HA3L-A1C61②			
			12V AC/DC ±10%	SPDT	HA3L-A1C53②			
				DPDT	HA3L-A1C63②			
			24V AC/DC ±10%	SPDT	HA3L-A1C54②			
				DPDT	HA3L-A1C64②			
Square w/Four-sided Barrier HA4L  	Momentary	Gold	5V DC ±5%	SPDT	HA4L-M1C11②		HA4L-M1C11V②	
				DPDT	HA4L-M1C21②		HA4L-M1C21V②	
			12V AC/DC ±10%	SPDT	HA4L-M1C13②		HA4L-M1C13V②	
				DPDT	HA4L-M1C23②		HA4L-M1C23V②	
			24V AC/DC ±10%	SPDT	HA4L-M1C14②		HA4L-M1C14V②	
				DPDT	HA4L-M1C24②		HA4L-M1C24V②	
		Silver	5V DC ±5%	SPDT	HA4L-M1C51②	—		
				DPDT	HA4L-M1C61②			
			12V AC/DC ±10%	SPDT	HA4L-M1C53②			
				DPDT	HA4L-M1C63②			
			24V AC/DC ±10%	SPDT	HA4L-M1C54②			
				DPDT	HA4L-M1C64②			
ø30 Mushroom HA1L-□3  	Momentary	Gold	5V DC ±5%	SPDT	HA1L-M3C11②		HA1L-M3C11V②	
				DPDT	HA1L-M3C21②		HA1L-M3C21V②	
			12V AC/DC ±10%	SPDT	HA1L-M3C13②		HA1L-M3C13V②	
				DPDT	HA1L-M3C23②		HA1L-M3C23V②	
			24V AC/DC ±10%	SPDT	HA1L-M3C14②		HA1L-M3C14V②	
				DPDT	HA1L-M3C24②		HA1L-M3C24V②	
		Silver	5V DC ±5%	SPDT	HA1L-M3C51②	—		
				DPDT	HA1L-M3C61②			
			12V AC/DC ±10%	SPDT	HA1L-M3C53②			
				DPDT	HA1L-M3C63②			
			24V AC/DC ±10%	SPDT	HA1L-M3C54②			
				DPDT	HA1L-M3C64②			
	Maintained	Gold	5V DC ±5%	SPDT	HA1L-A3C11②		HA1L-A3C11V②	
				DPDT	HA1L-A3C21②		HA1L-A3C21V②	
			12V AC/DC ±10%	SPDT	HA1L-A3C13②		HA1L-A3C13V②	
				DPDT	HA1L-A3C23②		HA1L-A3C23V②	
			24V AC/DC ±10%	SPDT	HA1L-A3C14②		HA1L-A3C14V②	
				DPDT	HA1L-A3C24②		HA1L-A3C24V②	
		Silver	5V DC ±5%	SPDT	HA1L-A3C51②	—		
				DPDT	HA1L-A3C61②			
			12V AC/DC ±10%	SPDT	HA1L-A3C53②			
				DPDT	HA1L-A3C63②			
			24V AC/DC ±10%	SPDT	HA1L-A3C54②			
				DPDT	HA1L-A3C64②			

A: amber
G: green
R: red
S: blue
W: white
Y: yellow

Note: Specify a lens color code in place of ② in the Type No.
Package quantity: 1

ø16 H6 Series Miniature Control Units

Dimensions (Illuminated Pushbuttons)

- Round
- Square
- Round w/Square Bezel

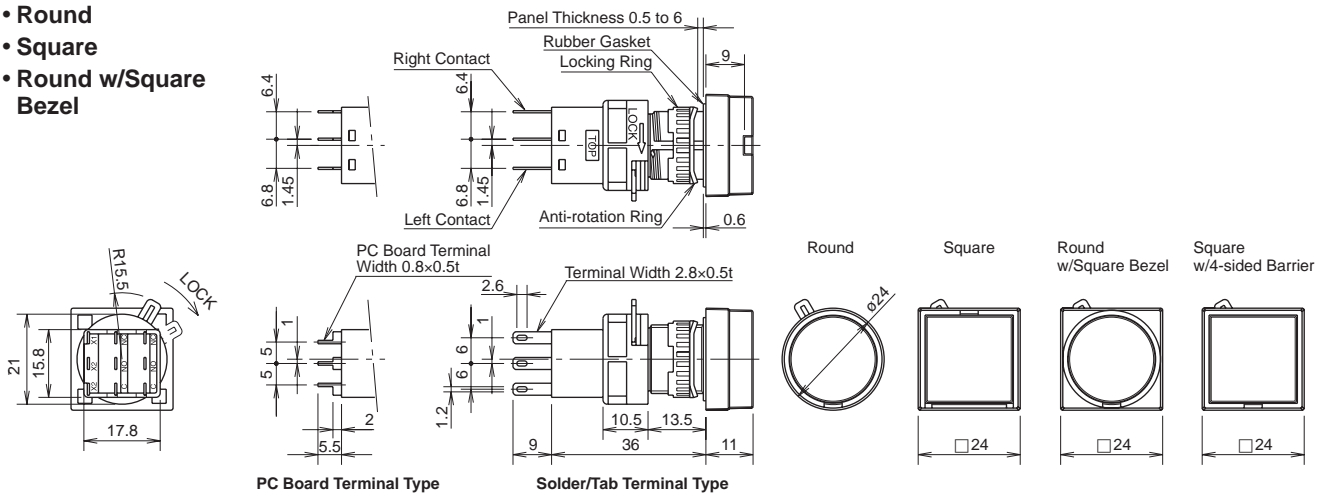

- Mushroom

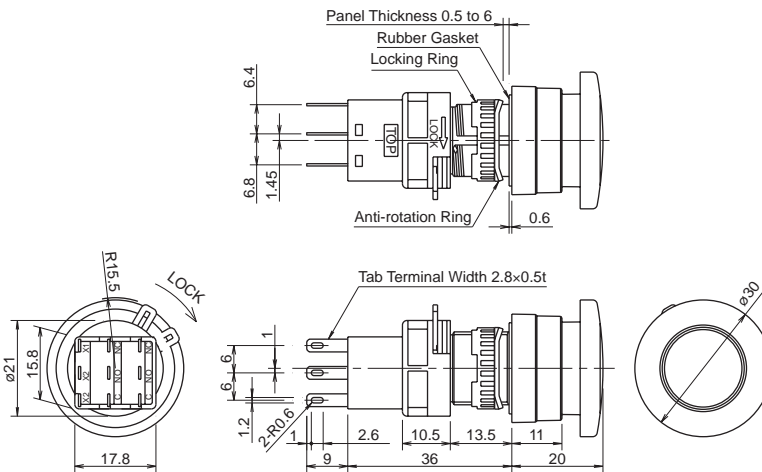

Mounting Hole Layout Mounting Centers

- Round
- Square
- Round w/Square Bezel

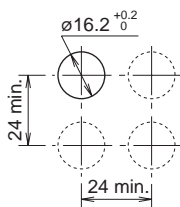

- Mushroom

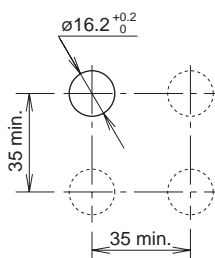

PC Board Drilling Layout (Bottom View)

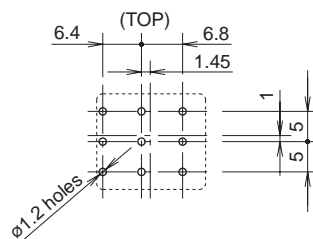

Terminal Arrangement (Bottom View)

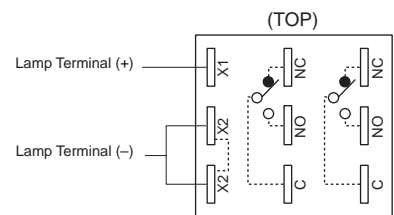





- SPDT has C, NO, and NC on the right only.
- X2 and X2 are wired internally.

Note: Determine mounting centers to ensure easy operation.

All dimensions in mm.





HA1P/HA2P/HA3P/HA4P LED Illuminated Pilot Lights

Separate Type

Shape	Operating Voltage	Type No.		② Lens Color Code
		Solder/Tab Terminal	PC Board Terminal	
Round HA1P  ㉴ ㉵ △ CE	5V DC ±5%	HA1P-1C01②	HA1P-1C01V②	Specify a color code in place of ② in the Type No. A: amber G: green R: red S: blue W: white Y: yellow
	12V AC/DC ±10%	HA1P-1C03②	HA1P-1C03V②	
	24V AC/DC ±10%	HA1P-1C04②	HA1P-1C04V②	
Square HA2P  ㉴ ㉵ △ CE	5V DC ±5%	HA2P-1C01②	HA2P-1C01V②	
	12V AC/DC ±10%	HA2P-1C03②	HA2P-1C03V②	
	24V AC/DC ±10%	HA2P-1C04②	HA2P-1C04V②	
Round w/Square Bezel HA3P  ㉴ ㉵ △ CE	5V DC ±5%	HA3P-1C01②	HA3P-1C01V②	
	12V AC/DC ±10%	HA3P-1C03②	HA3P-1C03V②	
	24V AC/DC ±10%	HA3P-1C04②	HA3P-1C04V②	
Square w/Four-sided Barrier HA4P  ㉴ ㉵ △ CE	5V DC ±5%	HA4P-1C01②	HA4P-1C01V②	
	12V AC/DC ±10%	HA4P-1C03②	HA4P-1C03V②	
	24V AC/DC ±10%	HA4P-1C04②	HA4P-1C04V②	









• See page 10 for dimensions.

Unibody Type

Shape	Operating Voltage	Type No.		② Lens Color Code
		Solder/Tab Terminal	PC Board Terminal	
Round HA1P  ㉴ ㉵ △ CE	5V DC ±5%	HA1P-11②	—	Specify a color code in place of ② in the Type No. A: amber G: green R: red S: blue W: white Y: yellow
	12V AC/DC ±10%	HA1P-13②	—	
	24V AC/DC ±10%	HA1P-14②	—	
Square HA2P  ㉴ ㉵ △ CE	5V DC ±5%	HA2P-11②	—	
	12V AC/DC ±10%	HA2P-13②	—	
	24V AC/DC ±10%	HA2P-14②	—	
Round w/Square Bezel HA3P  ㉴ ㉵ △ CE	5V DC ±5%	HA3P-11②	—	
	12V AC/DC ±10%	HA3P-13②	—	
	24V AC/DC ±10%	HA3P-14②	—	
Square w/Four-sided Barrier HA4P  ㉴ ㉵ △ CE	5V DC ±5%	HA4P-11②	—	
	12V AC/DC ±10%	HA4P-13②	—	
	24V AC/DC ±10%	HA4P-14②	—	

• See page 10 for dimensions.









HA1B/HA2B/HA3B/HA4B Pushbuttons

Shape	Button Type	Operation Type	Contact		Type No.		Color Code ①②
					Solder/Tab Terminal	PC Board Terminal	
Round HA1B-□1  	Button	Momentary	Gold	SPDT	HA1B-M1C1①	HA1B-M1C1V①	B: black G: green R: red S: blue W: white Y: yellow
				DPDT	HA1B-M1C2①	HA1B-M1C2V①	
			Silver	SPDT	HA1B-M1C5①	—	
		DPDT		HA1B-M1C6①	—		
		Maintained	Gold	SPDT	HA1B-A1C1①	HA1B-A1C1V①	
				DPDT	HA1B-A1C2①	HA1B-A1C2V①	
	Silver		SPDT	HA1B-A1C5①	—		
		DPDT	HA1B-A1C6①	—			
	Illumination Lens	Momentary	Gold	SPDT	HA1B-M1C1L②	HA1B-M1C1VL②	A: amber G: green R: red S: blue W: white Y: yellow
				DPDT	HA1B-M1C2L②	HA1B-M1C2VL②	
			Silver	SPDT	HA1B-M1C5L②	—	
		DPDT		HA1B-M1C6L②	—		
Maintained		Gold	SPDT	HA1B-A1C1L②	HA1B-A1C1VL②		
			DPDT	HA1B-A1C2L②	HA1B-A1C2VL②		
	Silver	SPDT	HA1B-A1C5L②	—			
DPDT		HA1B-A1C6L②	—				
Square HA2B-□1  	Button	Momentary	Gold	SPDT	HA2B-M1C1①	HA2B-M1C1V①	B: black G: green R: red S: blue W: white Y: yellow
				DPDT	HA2B-M1C2①	HA2B-M1C2V①	
			Silver	SPDT	HA2B-M1C5①	—	
		DPDT		HA2B-M1C6①	—		
		Maintained	Gold	SPDT	HA2B-A1C1①	HA2B-A1C1V①	
				DPDT	HA2B-A1C2①	HA2B-A1C2V①	
	Silver		SPDT	HA2B-A1C5①	—		
		DPDT	HA2B-A1C6①	—			
	Illumination Lens	Momentary	Gold	SPDT	HA2B-M1C1L②	HA2B-M1C1VL②	A: amber G: green R: red S: blue W: white Y: yellow
				DPDT	HA2B-M1C2L②	HA2B-M1C2VL②	
			Silver	SPDT	HA2B-M1C5L②	—	
		DPDT		HA2B-M1C6L②	—		
Maintained		Gold	SPDT	HA2B-A1C1L②	HA2B-A1C1VL②		
			DPDT	HA2B-A1C2L②	HA2B-A1C2VL②		
	Silver	SPDT	HA2B-A1C5L②	—			
DPDT		HA2B-A1C6L②	—				
Round w/Square Bezel HA3B-□1  	Button	Momentary	Gold	SPDT	HA3B-M1C1①	HA3B-M1C1V①	B: black G: green R: red S: blue W: white Y: yellow
				DPDT	HA3B-M1C2①	HA3B-M1C2V①	
			Silver	SPDT	HA3B-M1C5①	—	
		DPDT		HA3B-M1C6①	—		
		Maintained	Gold	SPDT	HA3B-A1C1①	HA3B-A1C1V①	
				DPDT	HA3B-A1C2①	HA3B-A1C2V①	
	Silver		SPDT	HA3B-A1C5①	—		
		DPDT	HA3B-A1C6①	—			
	Illumination Lens	Momentary	Gold	SPDT	HA3B-M1C1L②	HA3B-M1C1VL②	A: amber G: green R: red S: blue W: white Y: yellow
				DPDT	HA3B-M1C2L②	HA3B-M1C2VL②	
			Silver	SPDT	HA3B-M1C5L②	—	
		DPDT		HA3B-M1C6L②	—		
Maintained		Gold	SPDT	HA3B-A1C1L②	HA3B-A1C1VL②		
			DPDT	HA3B-A1C2L②	HA3B-A1C2VL②		
	Silver	SPDT	HA3B-A1C5L②	—			
DPDT		HA3B-A1C6L②	—				
Square w/Four-sided Barrier HA4B-M1  	Button	Momentary	Gold	SPDT	HA4B-M1C1①	HA4B-M1C1V①	B: black G: green R: red S: blue W: white Y: yellow
				DPDT	HA4B-M1C2①	HA4B-M1C2V①	
			Silver	SPDT	HA4B-M1C5①	—	
	DPDT	HA4B-M1C6①		—			
	Illumination Lens	Maintained	Gold	SPDT	HA4B-M1C1L②	HA4B-M1C1VL②	A: amber G: green R: red S: blue W: white Y: yellow
				DPDT	HA4B-M1C2L②	HA4B-M1C2VL②	
Silver			SPDT	HA4B-M1C5L②	—		
	DPDT	HA4B-M1C6L②	—				

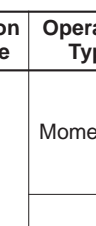
- Specify a color code in place of ① or ② in the Type No.
- For dimensions, see page 13.

ø16 H6 Series Miniature Control Units

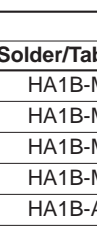
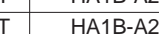
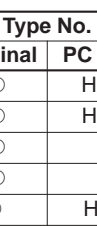
HA1B/HA2B/HA3B/HA4B Pushbuttons

Shape	Button Type	Operation Type	Contact		Type No.		Color Code ①		
					Solder/Tab Terminal	PC Board Terminal			
Round HA1B-□2  	Button	Momentary	Gold	SPDT	HA1B-M2C1①	HA1B-M2C1V①	B: black G: green R: red S: blue W: white Y: yellow		
				DPDT	HA1B-M2C2①	HA1B-M2C2V①			
			Silver	SPDT	HA1B-M2C5①	—			
				DPDT	HA1B-M2C6①	—			
		Maintained	Gold	SPDT	HA1B-A2C1①	HA1B-A2C1V①			
				DPDT	HA1B-A2C2①	HA1B-A2C2V①			
			Silver	SPDT	HA1B-A2C5①	—			
				DPDT	HA1B-A2C6①	—			
		Square HA2B-□2  	Button	Momentary	Gold	SPDT		HA2B-M2C1①	HA2B-M2C1V①
						DPDT		HA2B-M2C2①	HA2B-M2C2V①
					Silver	SPDT		HA2B-M2C5①	—
						DPDT		HA2B-M2C6①	—
Maintained	Gold			SPDT	HA2B-A2C1①	HA2B-A2C1V①			
				DPDT	HA2B-A2C2①	HA2B-A2C2V①			
	Silver			SPDT	HA2B-A2C5①	—			
				DPDT	HA2B-A2C6①	—			
Round w/Square Bezel HA3B-□2  	Button			Momentary	Gold	SPDT	HA3B-M2C1①	HA3B-M2C1V①	
						DPDT	HA3B-M2C2①	HA3B-M2C2V①	
					Silver	SPDT	HA3B-M2C5①	—	
						DPDT	HA3B-M2C6①	—	
		Maintained	Gold	SPDT	HA3B-A2C1①	HA3B-A2C1V①			
				DPDT	HA3B-A2C2①	HA3B-A2C2V①			
			Silver	SPDT	HA3B-A2C5①	—			
				DPDT	HA3B-A2C6①	—			
		Square w/Four-sided Barrier HA4B-M2  	Button	Momentary	Gold	SPDT	HA4B-M2C1①	HA4B-M2C1V①	
						DPDT	HA4B-M2C2①	HA4B-M2C2V①	
					Silver	SPDT	HA4B-M2C5①	—	
						DPDT	HA4B-M2C6①	—	
Round HA1B-□3  	Button			Momentary	Gold	SPDT	HA1B-M3C1①	HA1B-M3C1V①	
						DPDT	HA1B-M3C2①	HA1B-M3C2V①	
					Silver	SPDT	HA1B-M3C5①	—	
						DPDT	HA1B-M3C6①	—	
				Maintained	Gold	SPDT	HA1B-A3C1①	HA1B-A3C1V①	
						DPDT	HA1B-A3C2①	HA1B-A3C2V①	
					Silver	SPDT	HA1B-A3C5①	—	
						DPDT	HA1B-A3C6①	—	

- Specify a color code in place of ① in the Type No.
- For dimensions, see page 13.

Dimensions (Pushbuttons)

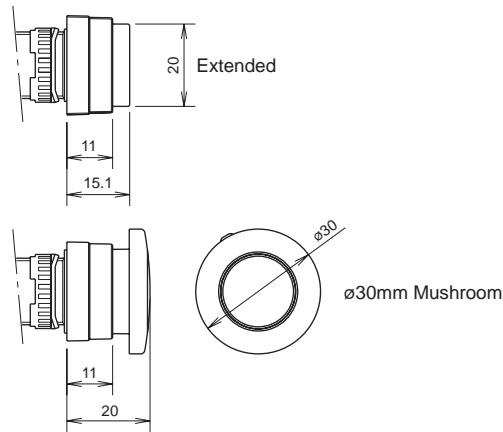
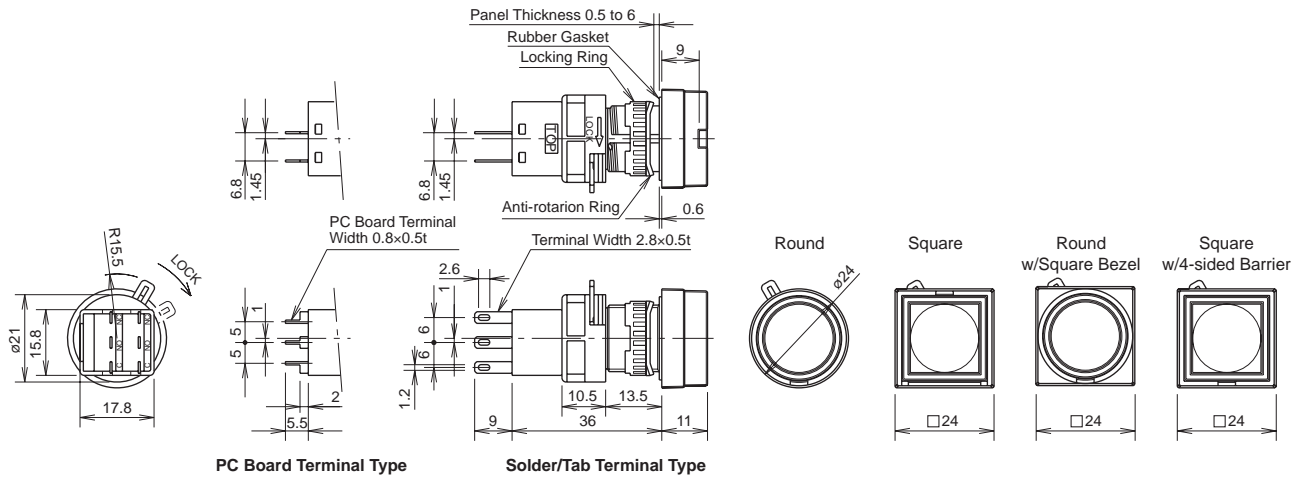

**Mounting Hole Layout
Mounting Centers**

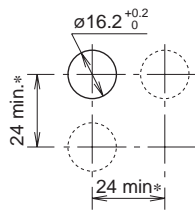

* 35 min. for mushroom type

Note: Determine mounting centers to ensure easy operation.

**PC Board Drilling Layout
(Bottom View)**

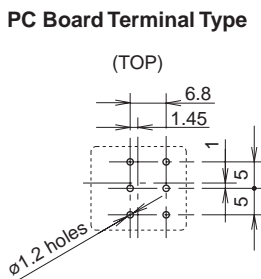



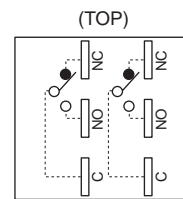











**Terminal Arrangement
(Bottom View)**



• SPDT has C, NO, and NC on the right only.



















All dimensions in mm.

HA1S/HA3S Selector Switches

Shape	Operator Position		Operation Type	Contact		Type No.	
						Solder/Tab Terminal	PC Board Terminal
Round HA1S  	90° 2-position	Maintained		Gold	SPDT	HA1S-2C1	HA1S-2C1V
					DPDT	HA1S-2C2	HA1S-2C2V
				Silver	SPDT	HA1S-2C5	—
		DPDT	HA1S-2C6		—		
		Spring return from right	Gold	SPDT	HA1S-21C1	HA1S-21C1V	
				DPDT	HA1S-21C2	HA1S-21C2V	
	Silver		SPDT	HA1S-21C5	—		
		DPDT	HA1S-21C6	—			
	45° 3-position	Maintained		Gold	DPDT	HA1S-3C2	HA1S-3C2V
					Silver	DPDT	HA1S-3C6
		Spring return from right		Gold	DPDT	HA1S-31C2	HA1S-31C2V
					Silver	DPDT	HA1S-31C6
Spring return from left			Gold	DPDT	HA1S-32C2	HA1S-32C2V	
				Silver	DPDT	HA1S-32C6	—
Spring return two-way		Gold	DPDT	HA1S-33C2	HA1S-33C2V		
			Silver	DPDT	HA1S-33C6	—	
Round w/Square Bezel HA3S  	90° 2-position	Maintained		Gold	SPDT	HA3S-2C1	HA3S-2C1V
					DPDT	HA3S-2C2	HA3S-2C2V
				Silver	SPDT	HA3S-2C5	—
		DPDT	HA3S-2C6		—		
		Spring return from right	Gold	SPDT	HA3S-21C1	HA3S-21C1V	
				DPDT	HA3S-21C2	HA3S-21C2V	
	Silver		SPDT	HA3S-21C5	—		
		DPDT	HA3S-21C6	—			
	45° 3-position	Maintained		Gold	DPDT	HA3S-3C2	HA3S-3C2V
					Silver	DPDT	HA3S-3C6
		Spring return from right		Gold	DPDT	HA3S-31C2	HA3S-31C2V
					Silver	DPDT	HA3S-31C6
Spring return from left			Gold	DPDT	HA3S-32C2	HA3S-32C2V	
				Silver	DPDT	HA3S-32C6	—
Spring return two-way		Gold	DPDT	HA3S-33C2	HA3S-33C2V		
			Silver	DPDT	HA3S-33C6	—	

- Bezel: black
- Knob: black with white indicator
- See page 15 for dimensions.

Contact Operation

Operator Position & Contact Operation (Top View)					
Positions		Contact	Left	Center	Right
90° 2-position	 Maintained  Spring return from right	SPDT		—	
		DPDT	Left Contact:  NO NC Right Contact:  NO NC	—	Left Contact:  NO NC Right Contact:  NO NC
45° 3-position	 Maintained  Spring return from right  Spring return from left  Spring return two-way	DPDT	Left Contact:  NO NC Right Contact:  NO NC	Left Contact:  NO NC Right Contact:  NO NC	Left Contact:  NO NC Right Contact:  NO NC

Dimensions (Selector Switch)

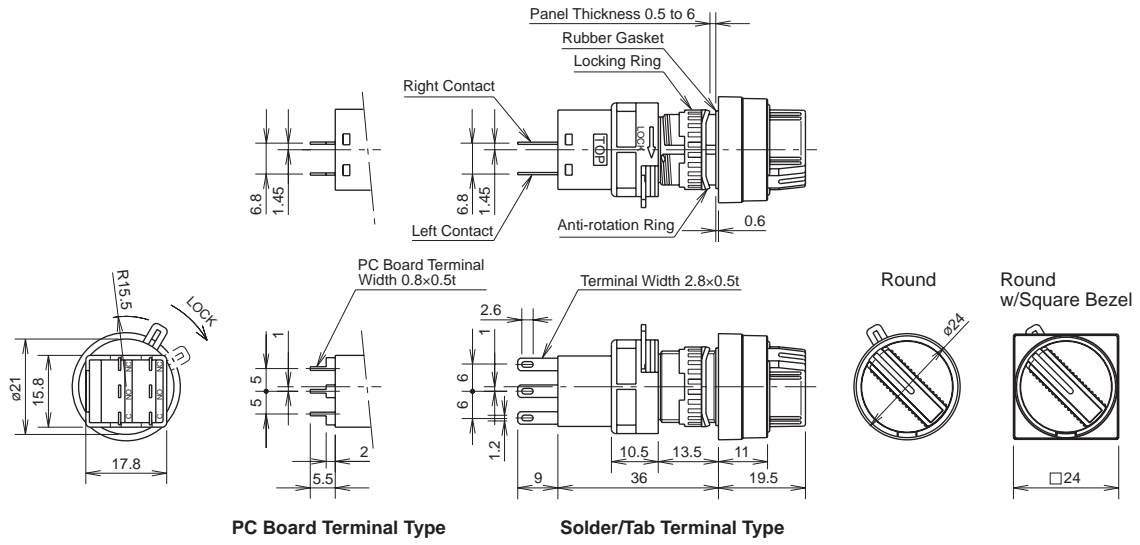

**Mounting Hole Layout
Mounting Centers**

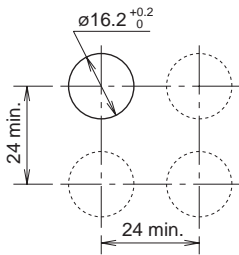

Note: Determine mounting centers to ensure easy operation.

**PC Board Drilling Layout
(Bottom View)**

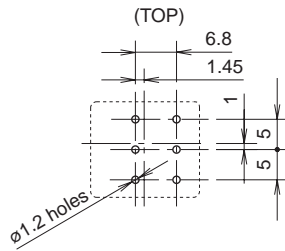



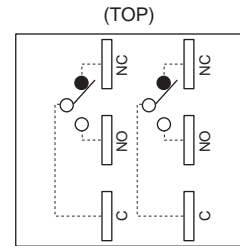

















**Terminal Arrangement
(Bottom View)**



• SPDT has C, NO, and NC on the right only.

All dimensions in mm.

HA1K Key Selector Switches







Shape	Operator Position	Keys Retained at ●	Contact	Type No.							
				Solder/Tab Terminal	PC Board Terminal						
Round HA1K  	90° 2-position	Maintained	A		Gold	SPDT	HA1K-2C1A	HA1K-2C1VA			
					DPDT	HA1K-2C2A	HA1K-2C2VA				
			Silver	SPDT	HA1K-2C5A	—					
				DPDT	HA1K-2C6A	—					
			B		Gold	SPDT	HA1K-2C1B	HA1K-2C1VB			
					DPDT	HA1K-2C2B	HA1K-2C2VB				
		Silver	SPDT	HA1K-2C5B	—						
			DPDT	HA1K-2C6B	—						
		C		Gold	SPDT	HA1K-2C1C	HA1K-2C1VC				
				DPDT	HA1K-2C2C	HA1K-2C2VC					
		Silver	SPDT	HA1K-2C5C	—						
			DPDT	HA1K-2C6C	—						
	Spring return from right	B		Gold	SPDT	HA1K-21C1B	HA1K-21C1VB				
				Silver	DPDT	HA1K-21C2B	HA1K-21C2VB				
				Gold	SPDT	HA1K-21C5B	—				
				Silver	DPDT	HA1K-21C6B	—				
				45° 3-position	Maintained	A		Gold	DPDT	HA1K-3C2A	HA1K-3C2VA
								Silver	DPDT	HA1K-3C6A	—
	B		Gold			DPDT	HA1K-3C2B	HA1K-3C2VB			
			Silver			DPDT	HA1K-3C6B	—			
	C		Gold			DPDT	HA1K-3C2C	HA1K-3C2VC			
			Silver			DPDT	HA1K-3C6C	—			
	D		Gold			DPDT	HA1K-3C2D	HA1K-3C2VD			
			Silver			DPDT	HA1K-3C6D	—			
	E		Gold			DPDT	HA1K-3C2E	HA1K-3C2VE			
			Silver			DPDT	HA1K-3C6E	—			
	G		Gold			DPDT	HA1K-3C2G	HA1K-3C2VG			
			Silver			DPDT	HA1K-3C6G	—			
	H		Gold	DPDT	HA1K-3C2H	HA1K-3C2VH					
			Silver	DPDT	HA1K-3C6H	—					
Spring return from right	B		Gold	DPDT	HA1K-31C2B	HA1K-31C2VB					
			Silver	DPDT	HA1K-31C6B	—					
	D		Gold	DPDT	HA1K-31C2D	HA1K-31C2VD					
			Silver	DPDT	HA1K-31C6D	—					
	G		Gold	DPDT	HA1K-31C2G	HA1K-31C2VG					
			Silver	DPDT	HA1K-31C6G	—					
Spring return from left	C		Gold	DPDT	HA1K-32C2C	HA1K-32C2VC					
			Silver	DPDT	HA1K-32C6C	—					
	D		Gold	DPDT	HA1K-32C2D	HA1K-32C2VD					
			Silver	DPDT	HA1K-32C6D	—					
	H		Gold	DPDT	HA1K-32C2H	HA1K-32C2VH					
			Silver	DPDT	HA1K-32C6H	—					
Spring return two-way	D		Gold	DPDT	HA1K-33C2D	HA1K-33C2VD					
			Silver	DPDT	HA1K-33C6D	—					

• Two keys are supplied.

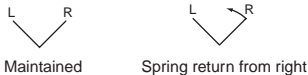

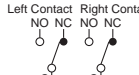

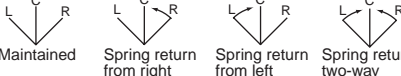
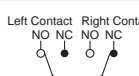
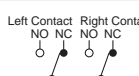













• The front of key cylinder is made of black plastic.

• See page 18 for dimensions.

Contact Operation

Operator Position & Contact Operation (Top View)					
Positions		Contact	↙ Left	↑ Center	↘ Right
90° 2-position		SPDT		—	
		DPDT		—	
45° 3-position		DPDT			

HA3K Key Selector Switches













Shape	Operator Position		Keys Retained at ●		Contact		Type No.				
							Solder/Tab Terminal	PC Board Terminal			
Round w/Square Bezel HA3K  ⚡ Ⓢ ⚠ Ⓜ Ⓜ Ⓜ	90° 2-position	Maintained	A		Gold	SPDT	HA3K-2C1A	HA3K-2C1VA			
						DPDT	HA3K-2C2A	HA3K-2C2VA			
			Silver	SPDT	HA3K-2C5A	—					
				DPDT	HA3K-2C6A	—					
			B		Gold	SPDT	HA3K-2C1B	HA3K-2C1VB			
						DPDT	HA3K-2C2B	HA3K-2C2VB			
		Silver	DPDT	SPDT	HA3K-2C5B	—					
				DPDT	HA3K-2C6B	—					
		C		Gold	SPDT	HA3K-2C1C	HA3K-2C1VC				
					DPDT	HA3K-2C2C	HA3K-2C2VC				
				Silver	SPDT	HA3K-2C5C	—				
					DPDT	HA3K-2C6C	—				
	Spring return from right	B		Gold	SPDT	HA3K-21C1B	HA3K-21C1VB				
					DPDT	HA3K-21C2B	HA3K-21C2VB				
				Silver	SPDT	HA3K-21C5B	—				
					DPDT	HA3K-21C6B	—				
				45° 3-position	Maintained	A		Gold	DPDT	HA3K-3C2A	HA3K-3C2VA
									Silver	DPDT	HA3K-3C6A
	B		Gold			DPDT	HA3K-3C2B	HA3K-3C2VB			
						Silver	DPDT	HA3K-3C6B	—		
	C		Gold			DPDT	HA3K-3C2C	HA3K-3C2VC			
						Silver	DPDT	HA3K-3C6C	—		
	D		Gold			DPDT	HA3K-3C2D	HA3K-3C2VD			
						Silver	DPDT	HA3K-3C6D	—		
	E		Gold			DPDT	HA3K-3C2E	HA3K-3C2VE			
						Silver	DPDT	HA3K-3C6E	—		
	G		Gold			DPDT	HA3K-3C2G	HA3K-3C2VG			
						Silver	DPDT	HA3K-3C6G	—		
	H		Gold	DPDT	HA3K-3C2H	HA3K-3C2VH					
				Silver	DPDT	HA3K-3C6H	—				
	Spring return from right	B		Gold	DPDT	HA3K-31C2B	HA3K-31C2VB				
					Silver	DPDT	HA3K-31C6B	—			
D			Gold	DPDT	HA3K-31C2D	HA3K-31C2VD					
				Silver	DPDT	HA3K-31C6D	—				
G			Gold	DPDT	HA3K-31C2G	HA3K-31C2VG					
				Silver	DPDT	HA3K-31C6G	—				
Spring return from left	C		Gold	DPDT	HA3K-32C2C	HA3K-32C2VC					
				Silver	DPDT	HA3K-32C6C	—				
	D		Gold	DPDT	HA3K-32C2D	HA3K-32C2VD					
				Silver	DPDT	HA3K-32C6D	—				
	H		Gold	DPDT	HA3K-32C2H	HA3K-32C2VH					
				Silver	DPDT	HA3K-32C6H	—				
Spring return two-way	D		Gold	DPDT	HA3K-33C2D	HA3K-33C2VD					
				Silver	DPDT	HA3K-33C6D	—				

• Two keys are supplied.

• The front of key cylinder is made with black plastic.

• See page 18 for dimensions.

Contact Operation

Operator Position & Contact Operation (Top View)					
Positions		Contact	↙ Left	↑ Center	↘ Right
90° 2-position	  Maintained Spring return from right	SPDT		—	
		DPDT		—	
45° 3-position	    Maintained Spring return from right Spring return from left Spring return two-way	DPDT			

Ø16 H6 Series Miniature Control Units

Dimensions (Key Selector Switch)

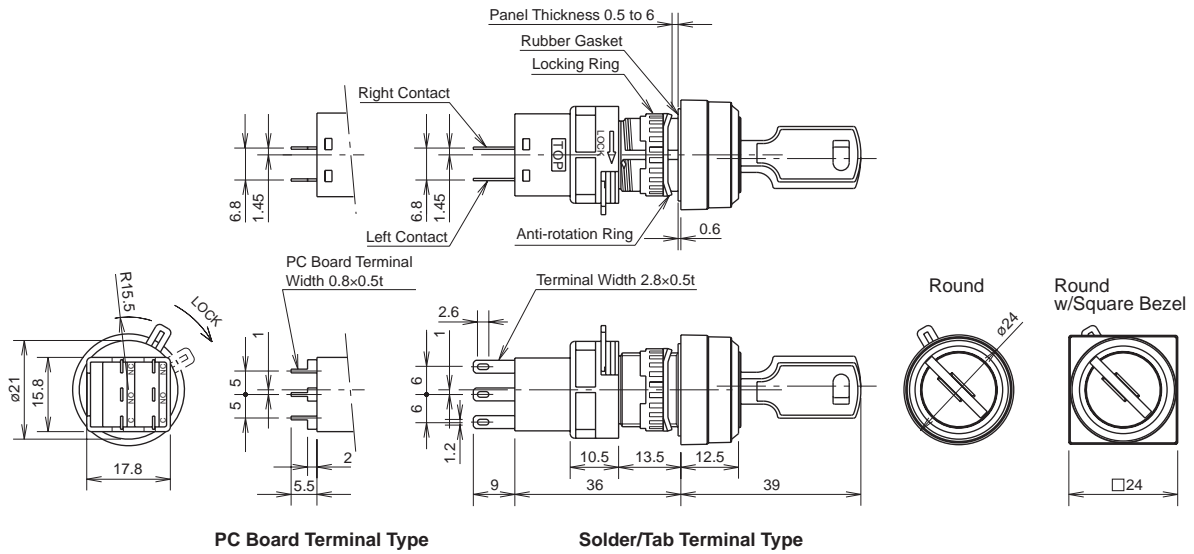

Mounting Hole Layout Mounting Centers

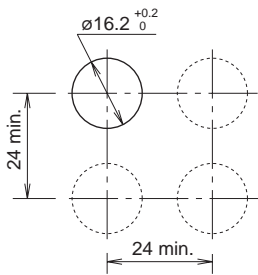

Note: Determine mounting centers to ensure easy operation.

PC Board Drilling Layout (Bottom View)

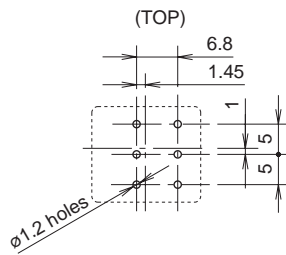



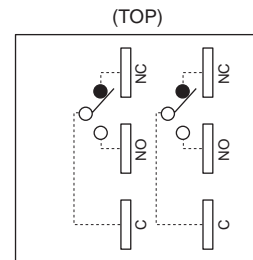





Terminal Arrangement (Bottom View)



• SPDT has C, NO, and NC on the right only.







All dimensions in mm.

HA1F LED Illuminated Selector Switches



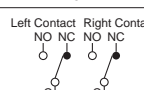
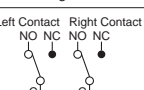
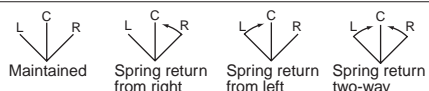

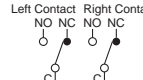



Shape	Operator Position	Contact Material	Operating Voltage	Contact	Type No.		Color Code ②	
					Solder/Tab Terminal	PC Board Terminal		
 	90° 2-position	Maintained 	5V DC ±5%	SPDT	HA1F-2C11②	HA1F-2C11V②	Specify a lens color code in place of ② in the Type No. A: amber G: green R: red S: blue W: white Y: yellow	
				DPDT	HA1F-2C21②	HA1F-2C21V②		
			12V AC/DC ±10%	SPDT	HA1F-2C13②	HA1F-2C13V②		
				DPDT	HA1F-2C23②	HA1F-2C23V②		
			24V AC/DC ±10%	SPDT	HA1F-2C14②	HA1F-2C14V②		
				DPDT	HA1F-2C24②	HA1F-2C24V②		
		Silver	5V DC ±5%	SPDT	HA1F-2C51②	—		
				DPDT	HA1F-2C61②			
			12V AC/DC ±10%	SPDT	HA1F-2C53②			
				DPDT	HA1F-2C63②			
			24V AC/DC ±10%	SPDT	HA1F-2C54②			
				DPDT	HA1F-2C64②			
		Spring return from right 	Gold	5V DC ±5%	SPDT	HA1F-21C11②		HA1F-21C11V②
					DPDT	HA1F-21C21②		HA1F-21C21V②
				12V AC/DC ±10%	SPDT	HA1F-21C13②		HA1F-21C13V②
					DPDT	HA1F-21C23②		HA1F-21C23V②
				24V AC/DC ±10%	SPDT	HA1F-21C14②		HA1F-21C14V②
					DPDT	HA1F-21C24②		HA1F-21C24V②
	Silver		5V DC ±5%	SPDT	HA1F-21C51②	—		
				DPDT	HA1F-21C61②			
			12V AC/DC ±10%	SPDT	HA1F-21C53②			
				DPDT	HA1F-21C63②			
			24V AC/DC ±10%	SPDT	HA1F-21C54②			
				DPDT	HA1F-21C64②			
	45° 3-position	Maintained 	Gold	5V DC ±5%	DPDT	HA1F-3C21②	HA1F-3C21V②	
				12V AC/DC ±10%	DPDT	HA1F-3C23②	HA1F-3C23V②	
			24V AC/DC ±10%	DPDT	HA1F-3C24②	HA1F-3C24V②		
				Silver	5V DC ±5%	DPDT	HA1F-3C61②	—
			12V AC/DC ±10%		DPDT	HA1F-3C63②		
			24V AC/DC ±10%	DPDT	HA1F-3C64②			
		Spring return from right 		Gold	5V DC ±5%	DPDT	HA1F-31C21②	
			12V AC/DC ±10%		DPDT	HA1F-31C23②	HA1F-31C23V②	
			24V AC/DC ±10%	DPDT	HA1F-31C24②	HA1F-31C24V②		
				Silver	5V DC ±5%	DPDT	HA1F-31C61②	—
			12V AC/DC ±10%		DPDT	HA1F-31C63②		
			24V AC/DC ±10%	DPDT	HA1F-31C64②			
Spring return from left 		Gold		5V DC ±5%	DPDT	HA1F-32C21②	HA1F-32C21V②	
			12V AC/DC ±10%	DPDT	HA1F-32C23②	HA1F-32C23V②		
		24V AC/DC ±10%	DPDT	HA1F-32C24②	HA1F-32C24V②			
			Silver	5V DC ±5%	DPDT	HA1F-32C61②	—	
		12V AC/DC ±10%		DPDT	HA1F-32C63②			
		24V AC/DC ±10%	DPDT	HA1F-32C64②				
Spring return two-way 	Gold		5V DC ±5%	DPDT	HA1F-33C21②	HA1F-33C21V②		
		12V AC/DC ±10%	DPDT	HA1F-33C23②	HA1F-33C23V②			
	24V AC/DC ±10%	DPDT	HA1F-33C24②	HA1F-33C24V②				
		Silver	5V DC ±5%	DPDT	HA1F-33C61②	—		
	12V AC/DC ±10%		DPDT	HA1F-33C63②				
	24V AC/DC ±10%	DPDT	HA1F-33C64②					

• See page 21 for dimensions.

Contact Operation



















Operator Position & Contact Operation (Top View)					
	Positions	Contact	Left	Center	Right
90° 2-position		SPDT		—	
		DPDT		—	
45° 3-position		DPDT			

HA3F LED Illuminated Selector Switches

Shape	Operator Position	Contact Material	Operating Voltage	Contact	Type No.		Color Code ②
					Solder/Tab Terminal	PC Board Terminal	
Round w/Square Bezel HA3F  UL   	90° 2-position	Maintained 	5V DC ±5%	SPDT	HA3F-2C11②	HA3F-2C11V②	Specify a lens color code in place of ② in the Type No. A: amber G: green R: red S: blue W: white Y: yellow
				DPDT	HA3F-2C21②	HA3F-2C21V②	
			12V AC/DC ±10%	SPDT	HA3F-2C13②	HA3F-2C13V②	
				DPDT	HA3F-2C23②	HA3F-2C23V②	
			24V AC/DC ±10%	SPDT	HA3F-2C14②	HA3F-2C14V②	
				DPDT	HA3F-2C24②	HA3F-2C24V②	
		Silver	5V DC ±5%	SPDT	HA3F-2C51②	—	
				DPDT	HA3F-2C61②		
			12V AC/DC ±10%	SPDT	HA3F-2C53②		
				DPDT	HA3F-2C63②		
			24V AC/DC ±10%	SPDT	HA3F-2C54②		
				DPDT	HA3F-2C64②		
	45° 3-position	Spring return from right 	5V DC ±5%	SPDT	HA3F-21C11②	HA3F-21C11V②	
				DPDT	HA3F-21C21②	HA3F-21C21V②	
			12V AC/DC ±10%	SPDT	HA3F-21C13②	HA3F-21C13V②	
				DPDT	HA3F-21C23②	HA3F-21C23V②	
			24V AC/DC ±10%	SPDT	HA3F-21C14②	HA3F-21C14V②	
				DPDT	HA3F-21C24②	HA3F-21C24V②	
		Silver	5V DC ±5%	SPDT	HA3F-21C51②	—	
				DPDT	HA3F-21C61②		
			12V AC/DC ±10%	SPDT	HA3F-21C53②		
				DPDT	HA3F-21C63②		
			24V AC/DC ±10%	SPDT	HA3F-21C54②		
				DPDT	HA3F-21C64②		
Maintained 	Gold	5V DC ±5%	DPDT	HA3F-3C21②	HA3F-3C21V②		
			DPDT	HA3F-3C23②	HA3F-3C23V②		
		12V AC/DC ±10%	DPDT	HA3F-3C24②	HA3F-3C24V②		
			DPDT	HA3F-3C61②	—		
		24V AC/DC ±10%	DPDT	HA3F-3C63②			
			DPDT	HA3F-3C64②			
	Silver	5V DC ±5%	DPDT	HA3F-31C21②		HA3F-31C21V②	
			DPDT	HA3F-31C23②		HA3F-31C23V②	
		12V AC/DC ±10%	DPDT	HA3F-31C24②		HA3F-31C24V②	
			DPDT	HA3F-31C61②	—		
		24V AC/DC ±10%	DPDT	HA3F-31C63②			
			DPDT	HA3F-31C64②			
Spring return from left 	5V DC ±5%	DPDT	HA3F-32C21②	HA3F-32C21V②			
		DPDT	HA3F-32C23②	HA3F-32C23V②			
	12V AC/DC ±10%	DPDT	HA3F-32C24②	HA3F-32C24V②			
		DPDT	HA3F-32C61②	—			
	24V AC/DC ±10%	DPDT	HA3F-32C63②				
		DPDT	HA3F-32C64②				
Spring return two-way 	5V DC ±5%	DPDT	HA3F-33C21②		HA3F-33C21V②		
		DPDT	HA3F-33C23②		HA3F-33C23V②		
	12V AC/DC ±10%	DPDT	HA3F-33C24②		HA3F-33C24V②		
		DPDT	HA3F-33C61②	—			
	24V AC/DC ±10%	DPDT	HA3F-33C63②				
		DPDT	HA3F-33C64②				

• See page 21 for dimensions.

Contact Operation

Operator Position & Contact Operation (Top View)					
Positions	Contact	Left	Center	Right	
90° 2-position  Maintained  Spring return from right	SPDT		—		
	DPDT	Left Contact:  NO NC Right Contact:  NO NC	—	Left Contact:  NO NC Right Contact:  NO NC	
45° 3-position  Maintained  Spring return from right  Spring return from left  Spring return two-way	DPDT	Left Contact:  NO NC Right Contact:  NO NC	Left Contact:  NO NC Right Contact:  NO NC	Left Contact:  NO NC Right Contact:  NO NC	

Dimensions (Illuminated Selector Switch)

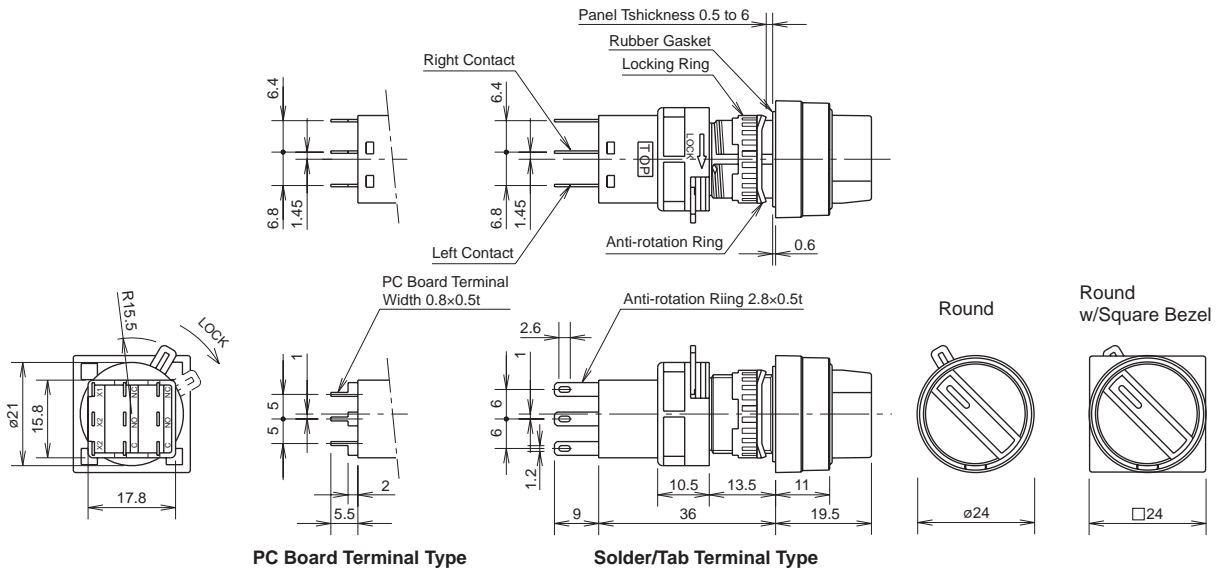

**Mounting Hole Layout
Mounting Centers**

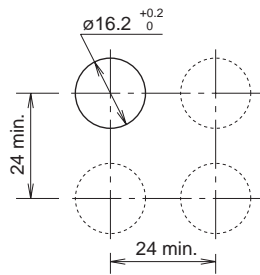

Note: Determine mounting centers to ensure easy operation.

**PC Board Drilling Layout
(Bottom View)**

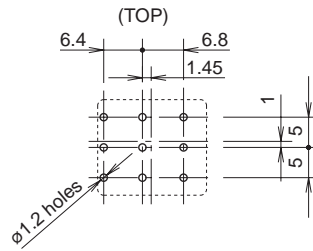

Note: For details, see page 30 about oneboard mounting.

**Terminal Arrangement
(Bottom View)**

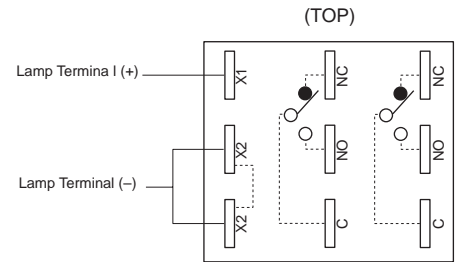































- SPDT has C, NO, and NC on the right only.
- X2 and X2 are wired internally.

All dimensions in mm.

ø16 H6 Series Miniature Control Units

HA1R Selector Pushbuttons

Shape	Operator Position	Contact Operation						Contact Material	Contact	Type No. Terminal Type	Color Code ①	
		L		C		R						
		Normal	Push	Normal	Push	Normal	Push					
 Round HA1R 	90° 2-position	Maintained	 Left Contact NO NC Right Contact NO NC	 Left Contact NO NC Right Contact NO NC	—	—	 Left Contact NO NC Right Contact NO NC	 Left Contact NO NC Right Contact NO NC	Gold	DPDT	Solder Tab Terminal HA1R-2C2①	
			 Left Contact NO NC Right Contact NO NC	 Left Contact NO NC Right Contact NO NC	—	—	 Left Contact NO NC Right Contact NO NC	 Left Contact NO NC Right Contact NO NC	Silver	DPDT	Solder Tab Terminal HA1R-2C6①	
			 Left Contact NO NC Right Contact NO NC	 Left Contact NO NC Right Contact NO NC	Blocked	Blocked	 Left Contact NO NC Right Contact NO NC	 Left Contact NO NC Right Contact NO NC	Gold	DPDT	Solder Tab Terminal HA1R-3C2①	
	 Left Contact NO NC Right Contact NO NC		 Left Contact NO NC Right Contact NO NC	 Left Contact NO NC Right Contact NO NC	 Left Contact NO NC Right Contact NO NC	Blocked	Blocked	Silver	DPDT	PC Board Terminal HA1R-3C2V①		
	 Left Contact NO NC Right Contact NO NC		 Left Contact NO NC Right Contact NO NC	 Left Contact NO NC Right Contact NO NC	 Left Contact NO NC Right Contact NO NC	Blocked	Blocked	 Left Contact NO NC Right Contact NO NC	 Left Contact NO NC Right Contact NO NC	Silver	DPDT	Solder Tab Terminal HA1R-3C6①
	 Left Contact NO NC Right Contact NO NC		 Left Contact NO NC Right Contact NO NC	 Left Contact NO NC Right Contact NO NC	 Left Contact NO NC Right Contact NO NC	Blocked	Blocked	 Left Contact NO NC Right Contact NO NC	 Left Contact NO NC Right Contact NO NC	—	—	—

• Specify a button color code in place of ① in the Type No.

Dimensions

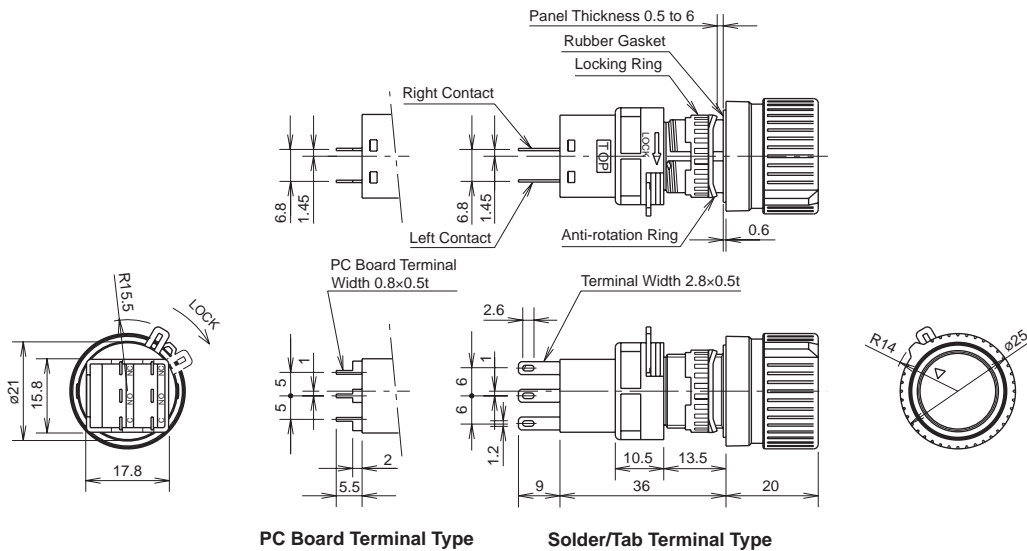

Mounting Hole Layout Mounting Centers

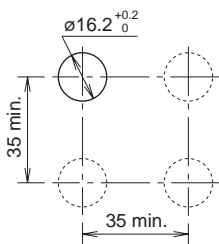

Note: Determine mounting centers to ensure easy operation.

PC Board Panel Cut-out (Bottom View)

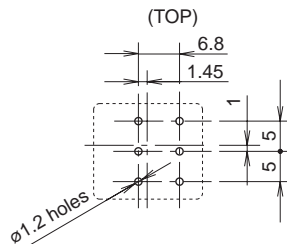



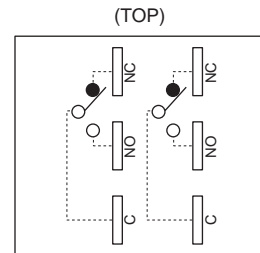

Note: For details, see page 30 about oneboard mounting.

Terminal Arrangement (Bottom View)



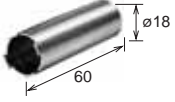

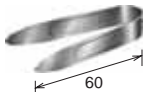

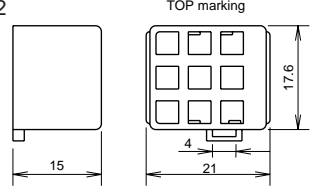
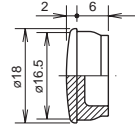
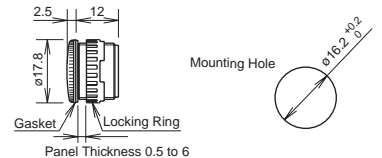

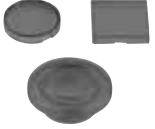
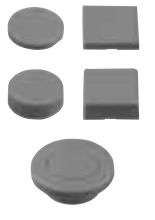

All dimensions in mm.

Accessories

Shape		Material	Type No.	Ordering Type No.	Package Quantity	Dimensions (mm)
		Metal (nickel-plated brass)	MT-001	MT-001	1	<ul style="list-style-type: none"> Used to tighten the locking ring when installing H6 control units into a panel. Tighten the locking ring to a torque of 0.88 N·m.
		Rubber	OR-44	OR-44	1	<ul style="list-style-type: none"> Used to install and remove LED lamps.
		Stainless Steel	MT-101	MT-101	1	<ul style="list-style-type: none"> Used to remove the lens or buttons.
	Standard	Guard (Polyarylate) Base (polyacetal)	HA9Z-K1	HA9Z-K1	1	<ul style="list-style-type: none"> Degree of protection: IP65 Used to protect flush pushbuttons from inadvertent operation. 
	For oneboard		HA9Z-KW1	HA9Z-KW1	1	
Terminal Cover	Standard	Nylon	H6-VL2	H6-VL2PN10	10	<ul style="list-style-type: none"> Terminal cover is not attached and must be ordered separately. When wiring the terminals, insert the lead wires into the terminal cover holes before soldering. 
	Exclusive for Unibody Pilot Light		H6-PVL	H6-PVLPN10	10	
Mounting Hole Plug	Rubber	Nitril Rubber (black)	AL-B6	AL-B6PN05	5	<ul style="list-style-type: none"> Degree of protection: IP65 
	Metal	Metal (diecast) Locking ring (plastic)	AL-BM6	AL-BM6	1	<ul style="list-style-type: none"> Degree of protection: IP65 

ø16 H6 Series Miniature Control Units

Maintenance Parts

Shape	Specification	Type No.	Ordering Type No.	Package Quantity	Color Code ①②	
	Round, Round w/Square Bezel	Polyarylate	HA9Z-L11②	HA9Z-L11②PN05	5	Specify a color code in place of ② in the Type No. A (amber), G (green), R (red), S (blue), W (white), Y (yellow)
	Square		HA9Z-L21②	HA9Z-L21②PN05		
	ø30mm Lens		HA9Z-L13②	HA9Z-L13②PN05		
	Round Flush, Round w/Square Bezel	Polyacetal	HA9Z-B11①	HA9Z-B11①PN05	5	Specify a color code in place of ① in the Type No. B (black), G (green), R (red), S (blue), W (white), Y (yellow)
	Square Flush		HA9Z-B21①	HA9Z-B21①PN05		
	Round Extended, Round Extended w/Square Bezel		HA9Z-B12①	HA9Z-B12①PN05		
	Square Extended		HA9Z-B22①	HA9Z-B22①PN05		
	ø30mm Button		HA9Z-B13①	HA9Z-B13①PN05		
	Round, Round w/Square Bezel	Acrylic	HA9Z-P1W	HA9Z-P1WPN05	5	<ul style="list-style-type: none"> • White • HA9Z-P1W (engraving area: ø16.4 mm, engraving depth: 0.5 mm max.) • HA9Z-P2W (engraving area: □16.4 mm, engraving depth: 0.5 mm max.)
	Square	Acrylic	HA9Z-P2W	HA9Z-P2WPN05		
	For all types	Plastic	HA9Z-LN	HA9Z-LNPN10	10	
	For all types except for HA1E	Stainless Steel	HA9Z-LP	HA9Z-LPPN10	5	
	For all types except for collective mounting and HA1E	Polyacetal	HA9Z-LS	HA9Z-LSPN10	5	<ul style="list-style-type: none"> • Lever lock is not attached and must be ordered separately. • Yellow
	For selector switch	Polyacetal	HA9Z-HC1①	HA9Z-HC1①PN05	5	Specify a color code in place of ① in the Type No. G (green), R (red), S (blue), W (white), Y (yellow)
	For key selector switches	Nickel-plated Brass	KG9Z-SK-231	KG9Z-SK-231PN02	2	<ul style="list-style-type: none"> • Thickness: 2.0mm • Two keys of the same number. Different key numbers are not available.
	For illuminated selector switch	Polyarylate (w/water-proof gasket)	HA1A-F②	HA1A-F②	1	Specify a color code in place of ② in the Type No. A (amber), G (green), R (red), S (blue), W (white), Y (yellow)

LED Lamps

Operating Voltage	Current Draw		Type No.	Ordering Type No.	② Illumination Color Code	Package Quantity	Base
	AC	DC					
5V DC ±5% 	—	8 mA	LFTD-5②	LFTD-5②	Specify a color code in place of ② in the Ordering Type No.	1	SX6S/8×5.4
				LFTD-5②PN10		10	
12V AC/DC ±10% 	9 mA	8 mA	LFTD-1②	LFTD-1②	A: amber G: green R: red S: blue W: white Y: yellow	1	
				LFTD-1②PN10		10	
24V AC/DC ±10% 	9 mA	8 mA	LFTD-2②	LFTD-2②		1	
				LFTD-2②PN10		10	

Transformer

Shape	Primary Voltage	Secondary Voltage	Type No.	Applicable LED Lamp
Separate Mounting Type for 24V 	100/110V AC	24V AC, 0.5W	TWR512	LFTD-2②
	200/220V AC		TWR522	
	400/440V AC		TWR542	

- Terminal covers are supplied with separate mounting type transformers.
- Connect only one LFTD LED to separate mounting type transformers.
- Use plastic mounting clip BC9Z-E/NS35N when using 400/440V primary voltage.

Specifications

Operating Voltage		100/110V AC, 200/220V AC, 400/440V AC (50/60 Hz)
Power Consumption		2.4VA
Rated Insulation Voltage		600V
Insulation Resistance		100 MΩ minimum (500V DC megger)
Dielectric Strength		2500V AC, 1 minute
Standard Operating Condition	Operating Temperature	−30 to +60°C (no freezing)
	Relative Humidity	35 to 85% (no condensation)
Vibration Resistance	Operating Extremes	5 to 55 Hz, amplitude 0.5 mm
Shock Resistance	Damage Limits	1,000 m/s ² (100G)
Terminal Screw		M3.5
Applicable Wire		2 mm ² maximum, 2 wires maximum

Dimensions

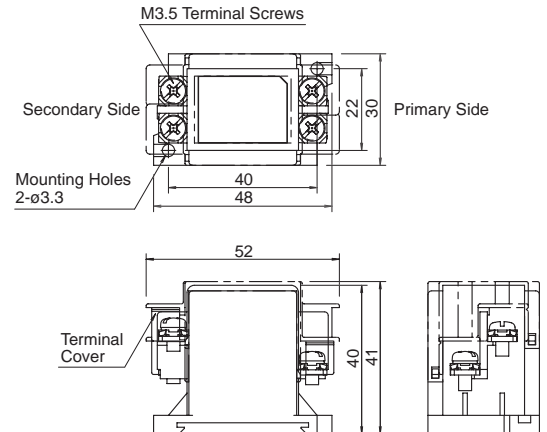

All dimensions in mm.

Accessories

Description	Appearance	Description	Type No.	Ordering Type No.	Package Quantity
DIN Rail		Aluminum Weight: Approx. 200g	BAA1000	BAA1000PN10	10
		Steel Weight: Approx. 320g	BAP1000	BAP1000PN10	
Mounting Clip		Steel Weight: Approx. 15g	BNL6	BNL6PN10	
		Plastic Weight: Approx. 15g	BC9Z-E/NS35N	BC9Z-E/NS35NPN10	

- Use plastic mounting clip BC9Z-E/NS35N when using 400/440V primary voltage.

Maintenance Parts

Dimensions

• Terminal Cover

For Separate Type (except for unibody type pilot lights)
(H6-VL2)

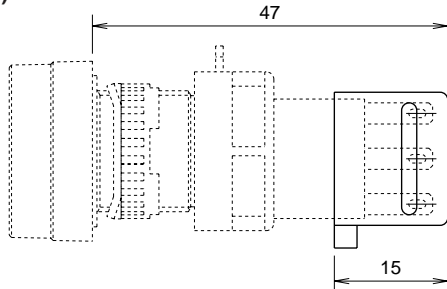

For Unibody Type Pilot Lights
(H6-PVL)

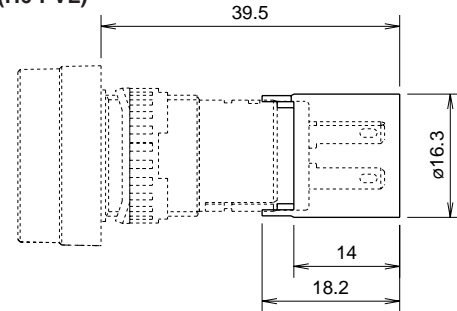

• Switch Guard

For Flush Pushbuttons and Illuminated Pushbuttons

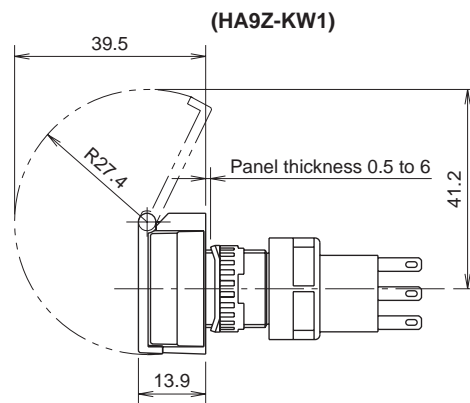
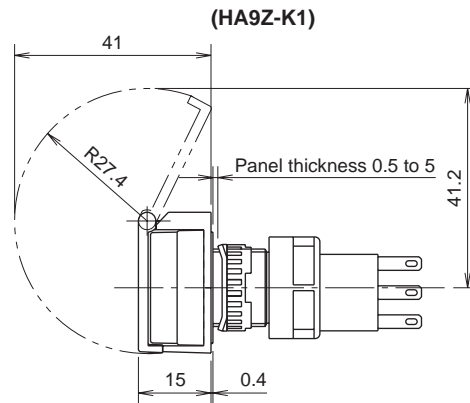
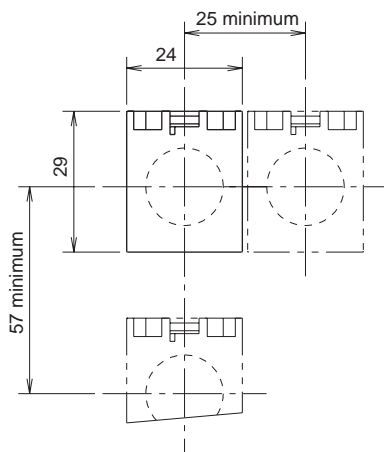

All dimensions in mm.

ø16 H6 Series Emergency Stop Switches

H6 Emergency Stop Switches

Contact Ratings

Rated Insulation Voltage (Ui)		250V			
Rated Thermal Current (Ith)		10A			
Rated Operating Voltage (Ue)		30V	125V	250V	
Rated Operating Current	AC 50/60 Hz	Resistive Load (AC-12)	—	5A	3A
		Inductive Load (AC-15)	—	3A	1.5A
	DC	Resistive Load (DC-12)	2A	0.4A	0.2A
		Inductive Load (DC-13)	1A	0.22A	0.1A

Minimum applicable load (reference value): 3V AC/DC, 5 mA
(Applicable range is subject to the operating condition and load.)

Contact Ratings

Applicable Standard	File No. or Organization
UL508	File No. E68961 (HA1E), E55996 (HA1B)
CSA C22.2 No. 14	File No. LR21451 (HA1B), E68961 (HA1E) (c-UL)
EN60947-5-5	DEMKO

Specifications



Operating Temperature	-25 to +60°C (no freezing)
Operating Humidity	45 to 85% RH (no condensation)
Storage Temperature	-30 to +80°C
Contact Resistance	50 mΩ maximum (initial value)
Insulation Resistance	100 MΩ minimum (500V DC megger)
Dielectric Strength	Between live and dead parts: 2,500V, 1 minute
	Between terminals of different poles: 2,500V, 1 minute Between terminals of the same pole: 1,000V, 1 minute
Vibration Resistance	Operating extremes: 5 to 55 Hz, amplitude 0.75 mm
	Damage limits: 100 m/s ² (10G)
Shock Resistance	Operating extremes: 300 m/s ² (30G) maximum
	Damage limits: 1,000 m/s ² (100G) maximum
Mechanical Durability	1,000,000 operations minimum
Electrical Durability	100,000 operations minimum
Degree of Protection	IP65
Terminal Style	Solder/tab terminal #110 (HA1B)
	Solder terminal (HA1E)
	PC board terminal
Weight (approx.)	HA1B-V2E2R: 23g
	HA1E-V2S2R: 19g

HA1B Emergency Stop Switch (Pushlock Turn Reset)

IDEC's Unique safety lock mechanism. Ideal for emergency stop of machine tools.

Features

- 36-mm depth behind the panel same as H6 and L6 series control units.
- Direct opening action mechanism (IEC 60947-5-1, Annex K)
- Safety lock mechanism to prevent inadvertent operation.
- The operator cannot be removed from the front of the panel.
- UL recognized, CSA certified, DEMKO approved.



Shape	Contact Material	Contact	Type No.		Button Color
			Solder/Tab Terminal	PC Board Terminal	
ø25mm Mushroom  	Silver Contact	1NC	HA1B-V2E1R	HA1B-V2E1VR	Red only
		2NC	HA1B-V2E2R	HA1B-V2E2VR	

HA1E Series Short Body Emergency Stop Switch (Pushlock Turn Reset)

Short 28.5-mm-long emergency stop switch suitable for installing on teaching pendants.

Features

- Short 28.5-mm-long body
- Direct opening action mechanism (IEC 60947-5-1, Annex K)
- Safety lock mechanism to prevent inadvertent operation.
- The operator cannot be removed from the front of the panel.
- UL recognized, CSA certified, DEMKO approved.

Shape	Contact Material	Contact	Type No.		Button Color
			Solder/Tab Terminal	PC Board Terminal	
ø25mm Mushroom  	Silver Contact	1NC	HA1E-V2S1R	HA1E-V2S1VR	Red only
		2NC	HA1E-V2S2R	HA1E-V2S2VR	

ø16 H6 Series Emergency Stop Switches

Dimensions (Emergency Stop Switch)

• HA1B

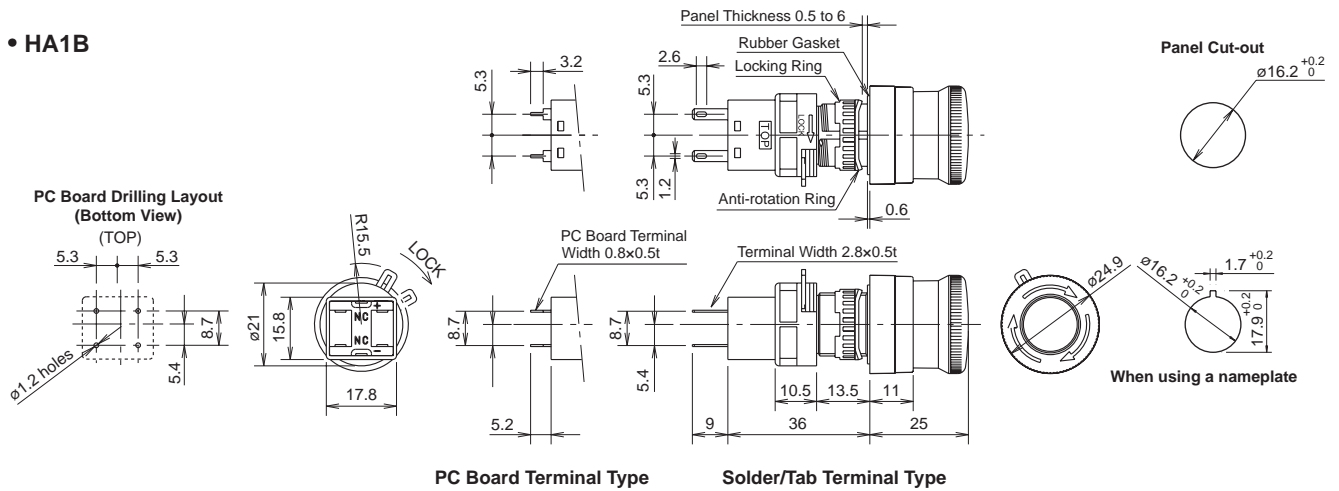

• HA1E

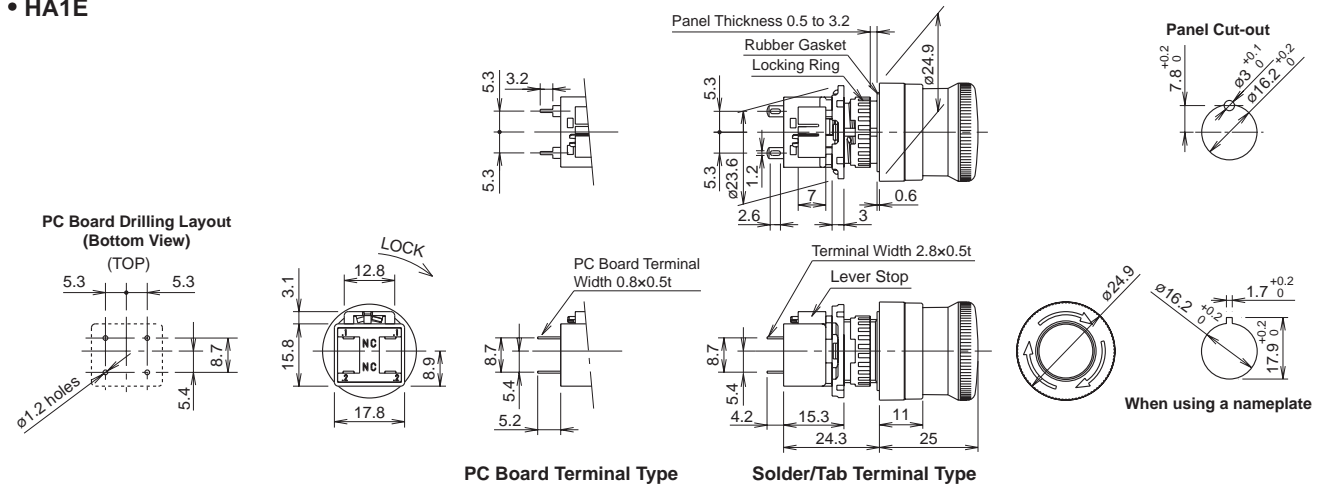

Terminal Arrangement (bottom view)

• HA1E

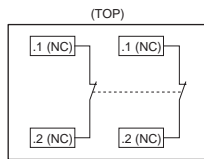

Note: 1NC type has contacts on the left only.

Accessories

• Nameplate for ø16mm Emergency Stop Switch



Type No.	Legend	Remarks
HAAV0	(blank)	Material: polyamide Background color: yellow
HAAV-27	EMERGENCY STOP	Legend color: black Package quantity: 1

• Dimensions

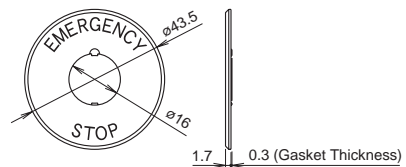

• Panel Cut-out

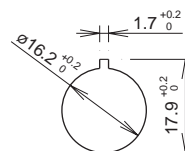

• Panel Thickness

HA1B-V2E□R: 0.5 to 4.4 mm
HA1E-V2S□R: 0.5 to 1.6 mm

All dimensions in mm.

Safety Precautions

- Turn off the power to H6 series control units before installation, removal, wiring, maintenance, and inspection of the control units. Failure to turn power off may cause electrical shocks or fire hazard.
- To avoid burning your hand, use the lamp holder tool when replacing lamps.
- For wiring, use wires of a proper gauge to meet voltage and current requirements. Improper soldering may cause overheating and create a fire hazard.

Instructions

Replacement of Lens and Marking Plate

• Removing the Lens Assembly

Remove the lens assembly (color lens, marking plate, and lens holder) by inserting a screwdriver into the recess of the lens through the bezel.



• Removing the Marking Plate

Remove the marking plate by pushing the lens from the rear to disengage the latches between the lens and the lens holder, using the screwdriver as shown below.

Note: The translucent filter in the lens holder cannot be removed because this filter is sealed to make the unit waterproof.

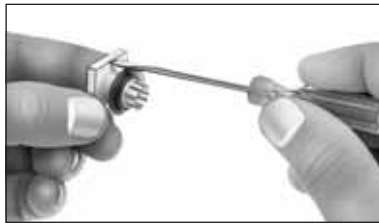

• Installing

For round lens types, place the marking plate on the lens holder with the projection engaged and press the lens onto the lens holder to engage the latches. For square lens types, insert the marking plate into the lens, and press the lens onto the holder to engage the latches.

Note: Make sure of correct orientation of the marking plate.

[Round Lens Type]

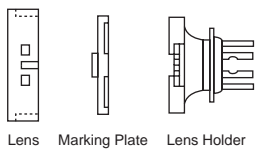

[Square Lens Type]

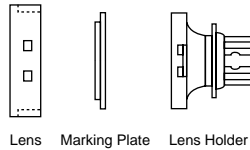

Replacement of Lamps

Lamps can be replaced using the lamp holder tool (OR-44) from the front of the panel, or by removing the contact block from the operator.

• Removing the Lamp

1. Slip the lamp holder tool onto the lamp head. Then push slightly, and turn the lamp holder tool counterclockwise.



2. Push the bulb, and remove from the rear of the lamp holder.

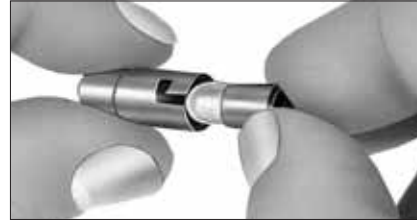

• Installing the Lamp

1. Insert the lamp into the lamp holder from the rear, and push in completely using the smaller end of the lamp holder tool.
2. Hold the bulb with the lamp holder tool as shown below.

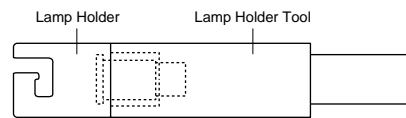

3. Place the insertion guide of the lamp holder and the TOP marking side or the groove in the operator unit in the same direction. Insert the lamp holder into the housing with the lamp holder tool. Then push the lamp lightly and turn it clockwise to install.

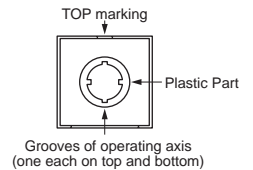

Panel Mounting

Remove the contact block from the operator. Insert the operator into the panel cut-out from the front, then install the contact block to the operator.

• Removing the Contact Block

Turn the locking lever on the contact block in the direction opposite to the arrow on the housing. Then the contact block can be removed.



• Installing the Contact Block

Insert the contact block with the TOP markings on the contact block and the operator placed in the same direction. Then lock the units, turning the locking lever in the direction of the arrow.

• Notes for Mounting

Use the optional Ring Wrench (MT-001) to mount the operator onto a panel. Tightening torque should not exceed 0.88 N·m. Do not use pliers. Do not tighten with excessive force, otherwise the locking ring will be damaged.

• Collective Mounting

As the locking lever can be turned easily from the rear of the units using a screwdriver, the contact blocks can be removed even when mounted collectively.

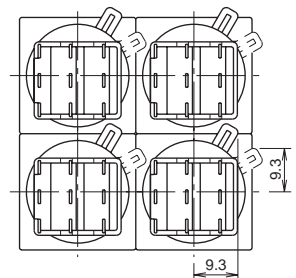

Instructions

Marking Plates and Films

For H6 series illuminated pushbuttons and pilot lights, legends and symbols can be engraved on marking plates, or printed mylar film can be inserted under the lens for labelling purposes.

• Marking Plate and Marking Film Size

Lens	Round Lens (round, round w/square bezel)	Square Lens
Built-in Marking Plate	<ul style="list-style-type: none"> Engraving must be made on the engraving area within 0.5mm deep. The marking plate is made of white acrylic resin. 	
Applicable Marking Film	<ul style="list-style-type: none"> Two 0.1mm-thick films or one 0.2mm-thick film can be installed in the lens. Marking film is not included. Recommended marking film: Polyester film 	

• Insertion Order of Marking Plate and Film

[Round Lens Type]

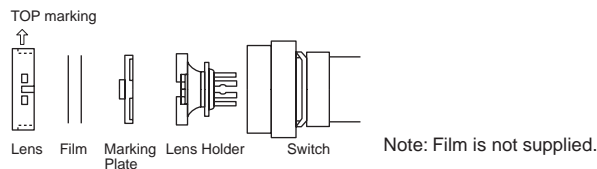

[Square Lens Type]

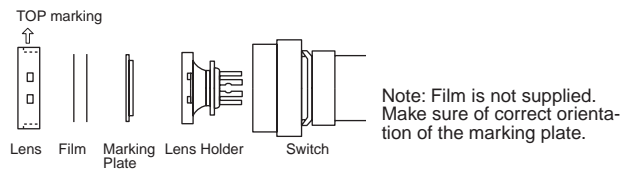

Wiring

- Solder the terminals at 350°C within 3 seconds using a 60W soldering iron. Sn-Ag-Cu type is recommended when using lead-free solder. When soldering, do not touch the control unit with the soldering iron. Also ensure that no tensile force is applied to the terminal. Do not bend the terminal or apply excessive force to the terminal.
- Use non-corrosive liquid flux.

Notes on Terminal Cover

Insert the terminal cover into the contact block with the TOP markings on the contact block and the terminal cover in the same direction.

Note: When wiring, insert the lead wires into the terminal cover holes before soldering.

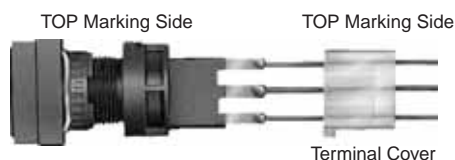

Connection

Positive-lock connector and easy-lock connector are applicable to tab terminals.

Recommended Connectors

Item	Positive-lock Connector (Tyco Electronics)		Easy-lock Connector (Nichifu Co., Ltd.)	
	Terminal	0.2 to 0.5 mm ²	175412-1	0.2 to 0.3 mm ²
	0.2 to 1.25 mm ²	174778-1	0.5 to 1.25 mm ²	OSS-62815F3
Housing	174779-1		NET1-28-1P	

Note: Positive-lock is a registered trademark of Tyco Electronics.

One Board Mounting

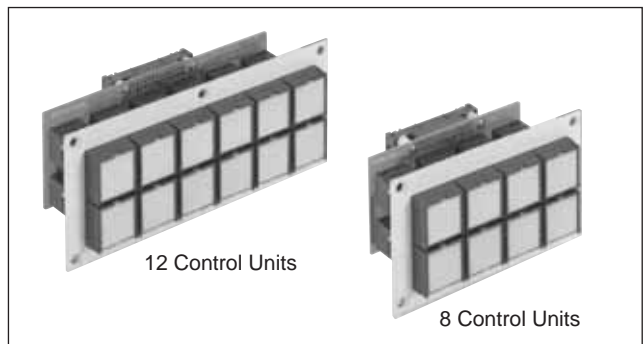

Mounting the PC board terminal type control units on a PC board offers the following features.

Features

- Reduced installation labor, easy wiring, space saving, and standardization.
- Since the contact blocks on the PC board can be removed easily using a locking lever, the H6 series control units are easy to maintain.
- Because the H6 series control units require no studs for fastening the control unit to a PC board, special preparation of the control panel is not needed.

Notes for Designing PC board and Circuit

- Use 1.6-mm-thick glass epoxy PC board with drilled holes.
- Design a circuit so that the H6 series control unit can operate within the rated voltage and current range. Make sure that inrush current and voltage do not exceed the rating.
- Minimum applicable load is 5V AC/DC, 1 mA on gold contacts. Applicable range is subject to the operating condition and load.
- Since the 2.8-mm-wide terminal touches the PC board as shown on the right, short circuit may occur with pattern lines. Design a circuit carefully to prevent short circuit.

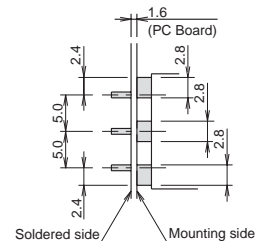

PC Board Drilling Layout

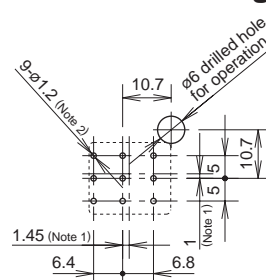

Note 1: When designing, note the alignment of centerlines of the contact blocks and centerlines of the operators.

Note 2: The diameter of the terminal hole is 1.2 mm.

Installation and Removal of Contact Blocks

Turn the locking lever to install and remove the contact block on the PC board by using a screwdriver from a hole (ø6 mm) of the PC board.

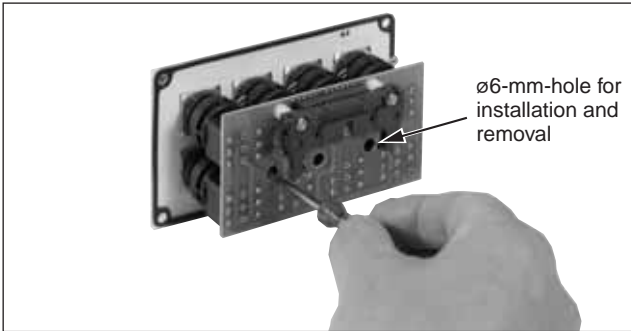

Hole diameter may vary to meet installation requirements. When the locking lever can be turned by using a screwdriver from the upper or right space, the holes are not necessary.

<Example>

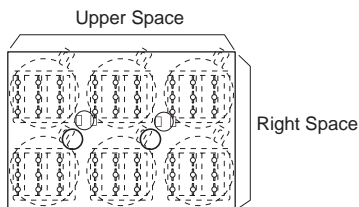

Mounting Holes and Assembly Procedure

- Drill mounting holes in the panel as shown below. When the units are mounted collectively, provide adequate clearance.

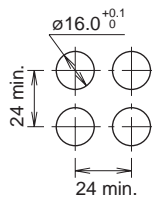

• Assembly Procedure

1. Install the operator to the operation panel.
2. Insert the contact block to the operator from the rear.
3. Turn the lock lever to lock the contact block.
4. Insert the PC board to terminals and solder.

Note 1: Make sure that each terminal is inserted into the PC board correctly.

Note 2: Do not apply tensile force to the connector cable for extended period of time.

Note 3: Do not expose the contact block to water.

Note 4: Ensure to lock contact blocks when the contact blocks are installed on the operators.

ø16

HA5W Series Oneboard Control Units

Reduces wiring and installation space. Achieves standard panel design.

Reduce time and space by using a PC board and flat cable solution. Standard panels can be designed with flexibility.

- The separate structure of operator and contact/board makes maintenance easy.
- IDEC's unique lock lever structure requires no studs on the board.
- H6 series control units can be used without modification.
- Available with I/O terminals for parallel wiring.

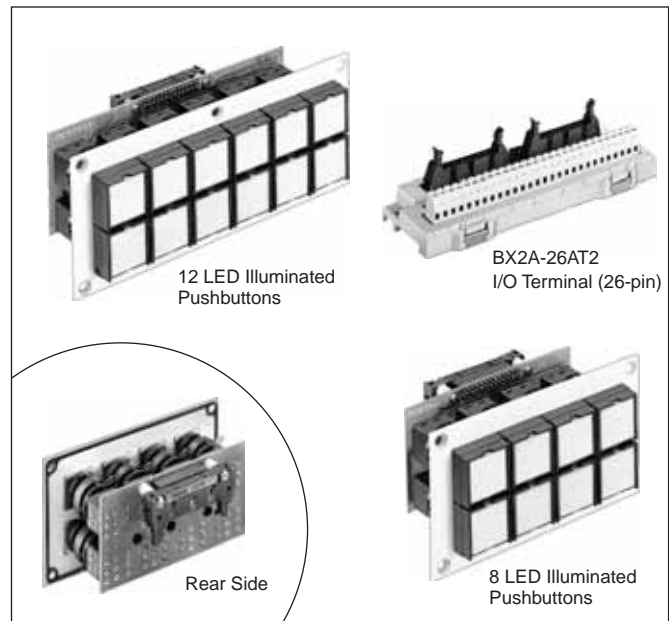

Types

No. of Control Units	Illumination Type	Operating Voltage	Type No.	Notes
8	LED	24V AC/DC ±10%	HA5W-84	Panel color: Munsell 5Y7/1
12		24V AC/DC ±10%	HA5W-24	

Contact Ratings

Rated Operating Voltage	24V DC
Rated Operating Current	30 mA (resistive load)
Contact Material	Gold-clad silver

Ordering Information

1. Specify a button or lens color code in the Type No. [Example]

HA5W-84 RRRR WW GG

Type No. Specify color codes for the control units in order of (1) to (8) (see below).

2. All units are supplied with an LED lamp.
3. Illuminated pushbuttons HA2L-M1C14V② (momentary, SPDT) are provided.

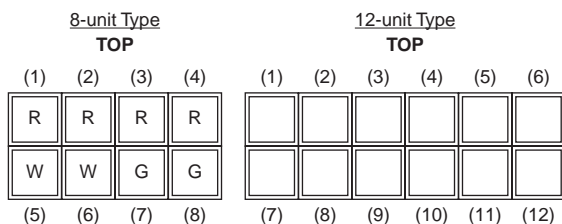

Built-in LED Lamp Ratings

Type No.	LFTD-2②
Base	SX6S/8×5.4
Operating Voltage	24V AC/DC ±10%
Rated Voltage	24V AC/DC
Current Draw	AC 9 mA
	DC 8 mA
Color Code ②	Specify a color code in place of ②. A (amber), G (green), R (red), S (blue), W (white), Y (yellow)
Lamp Base Color	Same as illumination color
Voltage Marking	Die stamped on the lamp base
Life (reference value)	Approx. 50,000 hours (When used on complete DC, luminance reduces to 50% of the initial intensity.)
Internal Circuit	A, R, W, Y
	G, S
	<ul style="list-style-type: none"> LED Chip Protection Diode Zener Diode

Dimensions

8-unit Type

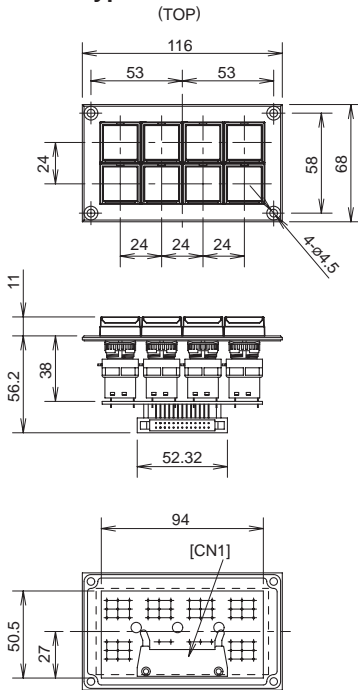

12-unit Type

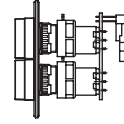
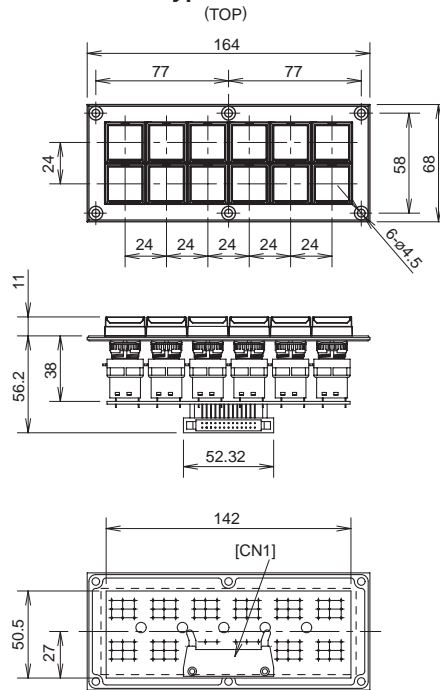

Wiring Diagram

8-unit Type

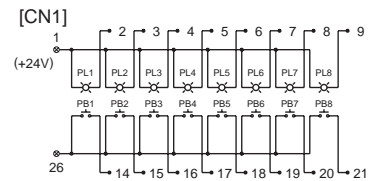

12-unit Type

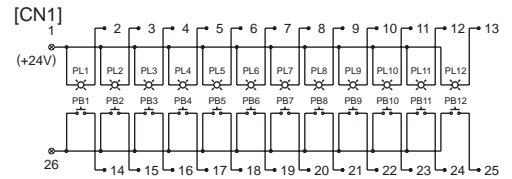

Panel Cut-out

8-unit Type

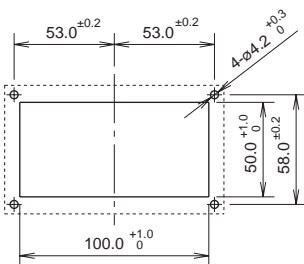

12-unit Type

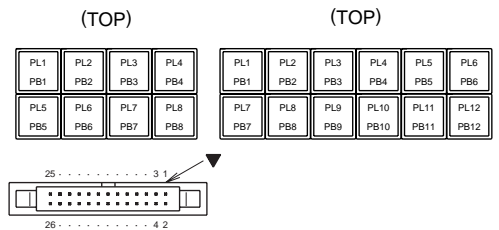
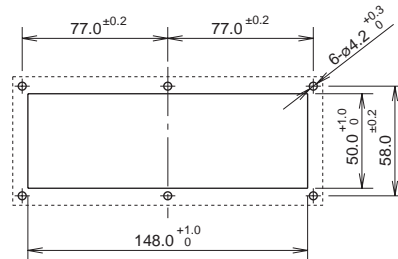

Installing and Removing the Contact Blocks/PC Board

The contact blocks and PC board can be installed and removed by operating the lock levers using a screwdriver as shown below.

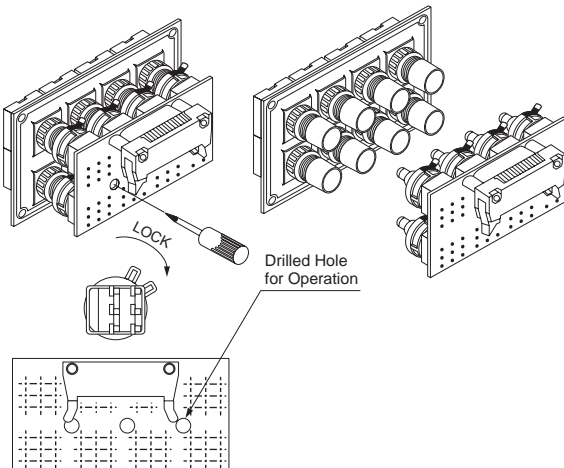

Degree of Protection

The HA5W Oneboard Control Units become IP65 when waterproof gasket is used on the mounting screws. The HA2L-M1C14V illuminated pushbuttons used on the HA5W are IP65.

Panel Mounting Screws

Use M4 countersunk screws for panel mounting.

All dimensions in mm.

Ø16 HA5W Series Oneboard Control Units

Wiring Example

For oneboard control units, use the connectors compliant with MIL standard.

IDEC's Applicable Connector

Type No.	Description
JE1S-261	26-pin, w/strain relief

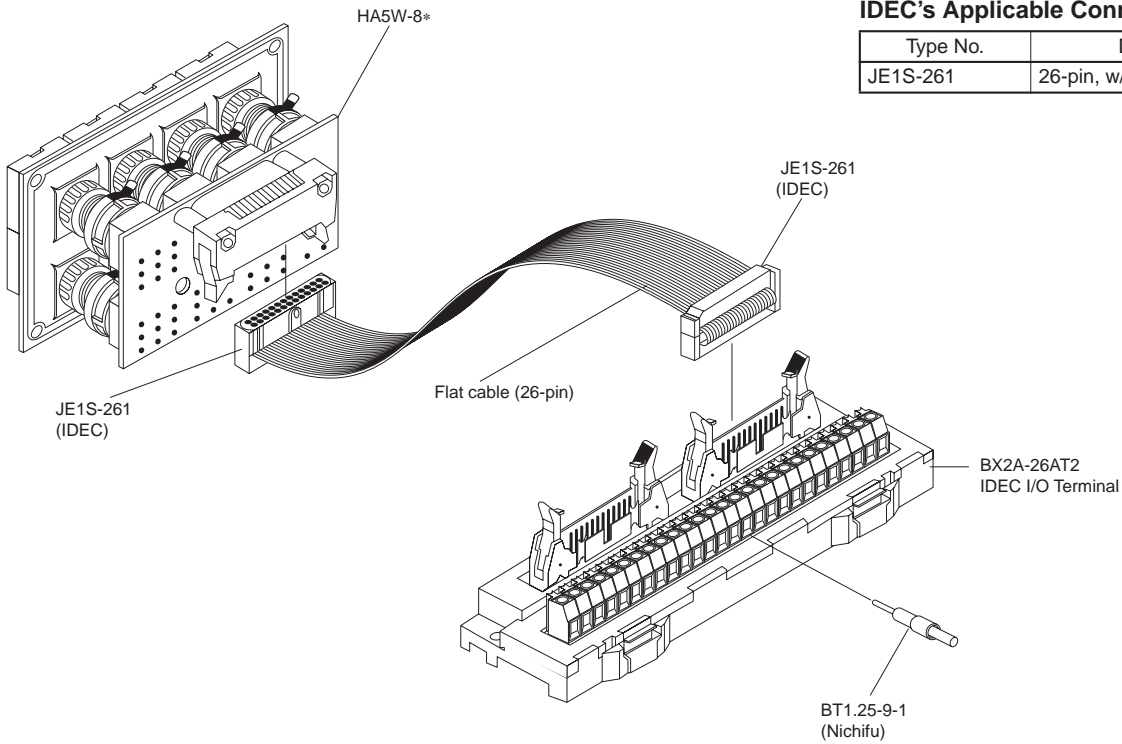

Safety Precautions

- Turn off the power to the oneboard control units before installation, removal, wiring, maintenance, and inspection. Failure to turn power off may cause electrical shocks or fire hazard.
- To avoid burning your hand, use the lamp holder tool when replacing lamps.

Specifications and other descriptions in this catalog are subject to change without notice.



IDEC CORPORATION

7-31, Nishi-Miyahara 1-Chome, Yodogawa-ku, Osaka 532-8550, Japan
Tel: +81-6-6398-2571, Fax: +81-6-6392-9731
E-mail: products@idec.co.jp

IDEC CORPORATION (USA)
1175 Elko Drive, Sunnyvale, CA 94089-2209, USA
Tel: +1-408-747-0550 / (800) 262-IDEC (4332)
Fax: +1-408-744-9055 / (800) 635-6246
E-mail: opencontact@idec.com

IDEC CANADA LIMITED
Unit 22-151, Brunel Road, Mississauga, Ontario,
L4Z 1X3, Canada
Tel: +1-905-890-8561, Toll Free: (888) 317-4332
Fax: +1-905-890-8562
E-mail: sales@ca.idec.com

IDEC AUSTRALIA PTY. LTD.
2/3 Macro Court, Rowville, Victoria 3178, Australia
Tel: +61-3-9763-3244, Toll Free: 1800-68-4332
Fax: +61-3-9763-3255
E-mail: sales@au.idec.com

IDEC ELECTRONICS LIMITED
Unit 2, Beechwood, Chineham Business Park,
Basingstoke, Hampshire RG24 8WA, UK
Tel: +44-1256-321000, Fax: +44-1256-327755
E-mail: sales@uk.idec.com

IDEC ELEKTROTECHNIK GmbH
Wendenstrasse 331, 20537 Hamburg, Germany
Tel: +49-40-25 30 54 - 0, Fax: +49-40-25 30 54 - 24
E-mail: service@idec.de

IDEC (SHANGHAI) CORPORATION
Room 608-609, 6F, Gangtai Plaza, No. 700,
Yan'an East Road, Shanghai 200001, PRC
Tel: +86-21-5353-1000, Fax: +86-21-5353-1263
E-mail: idec@cn.idec.com

IDEC (BEIJING) CORPORATION
Room 211B, Tower B, The Grand Pacific Building,
8A Guanghua Road, Chaoyang District,
Beijing 100026, PRC
Tel: +86-10-6581-6131, Fax: +86-10-6581-5119

IDEC (SHENZHEN) CORPORATION
Unit AB-3B2, Tian Xiang Building, Tian'an Cyber Park,
Fu Tian District, Shenzhen, Guang Dong 518040, PRC
Tel: +86-755-8356-2977, Fax: +86-755-8356-2944

IDEC IZUMI (H.K.) CO., LTD.
Unit 1505-07, DCH Commercial Centre No. 25,
Westlands Road, Quarry Bay, Hong Kong
Tel: +852-2803-8989, Fax: +852-2565-0171
E-mail: info@hk.idec.com

IDEC TAIWAN CORPORATION
8F-1, No. 79, Hsin Tai Wu Road, Sec. 1,
Hsi-Chih, Taipei County, Taiwan
Tel: +886-2-2698-3929, Fax: +886-2-2698-3931
E-mail: service@idectwn.com.tw

IDEC IZUMI ASIA PTE. LTD.
No. 31, Tannery Lane #05-01, Dragon Land
Building, Singapore 347788
Tel: +65-6746-1155, Fax: +65-6844-5995
E-mail: info@sg.idec.com

X-ON Electronics

Largest Supplier of Electrical and Electronic Components

Click to view similar products for [Keylock Switches](#) category:

Click to view products by [Idec](#) manufacturer:

Other Similar products are found below :

[89496-09](#) [58J1007](#) [58J8A45-01B05N](#) [719-0201-000](#) [719-0202-000](#) [719-0702-000](#) [719-5504-000](#) [84800-04](#) [GKNC33L](#) [GKNC3L](#)
[PVA2OAH5](#) [HA1K-2C2VA-2](#) [14-235.022K](#) [AS6H-2K2A](#) [AS6M-2K1B](#) [AS6Q-2K2A](#) [AS6Q-3K2A](#) [1571487-1](#) [KEY-AS6](#) [KH3C-20C](#)
[8928K493](#) [2SWK131AL102](#) [AS6M-2K1A](#) [AS6Q-2K1PB](#) [51-401.036D](#) [51-414.036D](#) [HW1K-31BF20](#) [HW1K-3HF20](#) [Y1112-2027CLFT](#)
[51-195.025D](#) [51-378.AD](#) [51-404.036D](#) [51-405.036D](#) [1-1437597-8](#) [58J8A36-01B04N](#) [58M1422](#) [86945-05](#) [719-0204-000](#) [719-0205-000](#)
[719-0801-000](#) [719-0804-000](#) [719-0805-000](#) [88422-18](#) [58J8A90-01B02N](#) [58J8A90-01C02N](#) [58J9P36-01B09N](#) [58J8A36-01C03N](#)
[GKRA3K1A2-F03-C](#) [GKBB14L6](#) [14-236.025K1020](#)