

HS7A Series





Compact and easy positioning.



• See website for details on approvals and standards.

* Coded magnetic switches can be used as an interlock switch only when used with a safety relay module designated by IDEC.

	Model	Features	Page
	HS7A-DMC	2-contact	E-095
	HS7A-DMP	3-contact	E-099

Operating principle (Reed switch)

The reed switch inside the coded magnetic switch turns ON (NO contact) or OFF (NC contact) when the magnet of the actuator comes close to the coded magnetic switch.

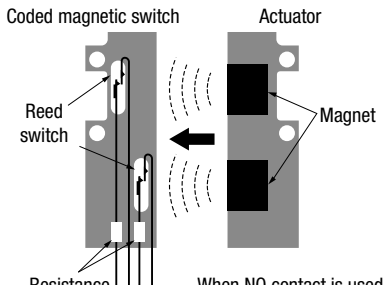

The switch cannot be defeated with a commercial magnet or a metal piece because multiple magnets are used.

Compact

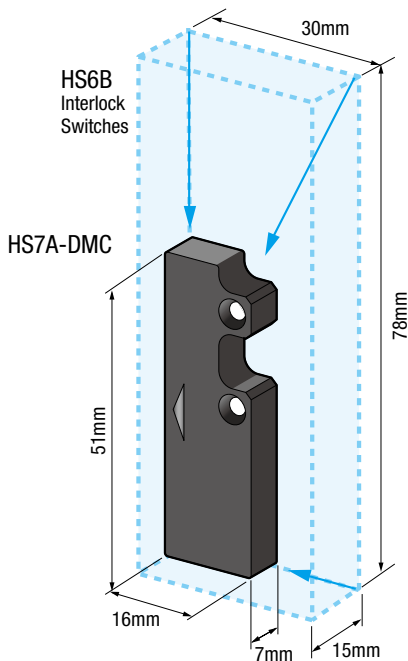

Easy positioning

Coded magnetic switches are ideal for mounting on protective doors that are difficult to position as there is space allowance to position with the actuator.



Actuator HS9Z-ZC1

IP67

Because the reed switch is filled with plastic, the switches have strong dust and waterproof characteristics and can be washed with water.

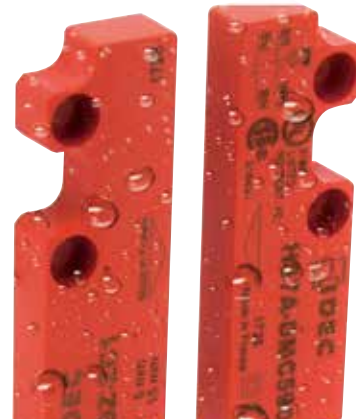

Safety category 4 (EN/ISO13849-1) compliant

By using the HS7A coded magnetic switch with HR6S safety module, up to safety category 4 (EN/ISO13849-1) can be achieved.



HR6S-S1

HR6S-DN1

Requirements for using the coded magnetic switches correctly

Coded magnetic switches do not have a direct opening function where a circuit is always shut off when the guard is opened. Therefore, a coded magnetic switch must be used in combination with an exclusive safety relay module.

Installation example

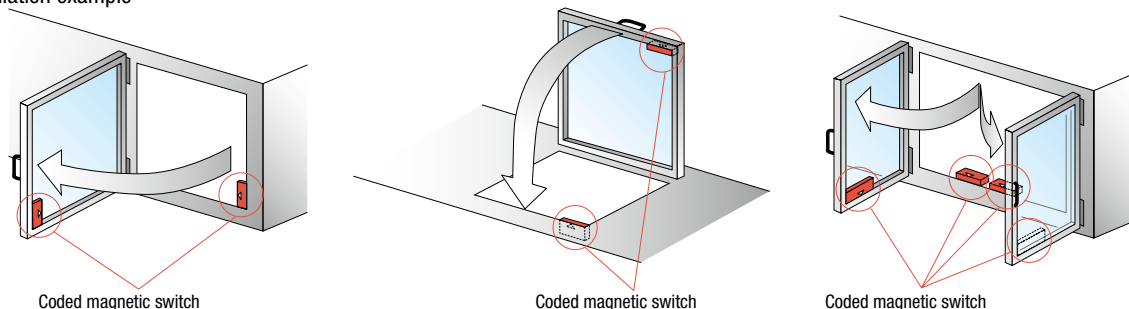

- APEM
- Switches & Pilot Lights
- Control Boxes
- Emergency Stop Switches
- Enabling Switches
- Safety Products
- Explosion Proof
- Terminal Blocks
- Relays & Sockets
- Circuit Protectors
- Power Supplies
- LED Illumination
- Controllers
- Operator Interfaces
- Sensors
- AUTO-ID

- Interlock Switches
- Coded Magnetic Switches
- Safety Laser Scanners
- Safety Light Curtains
- Safety Modules

- HS7A
- HR1S
- HS3A

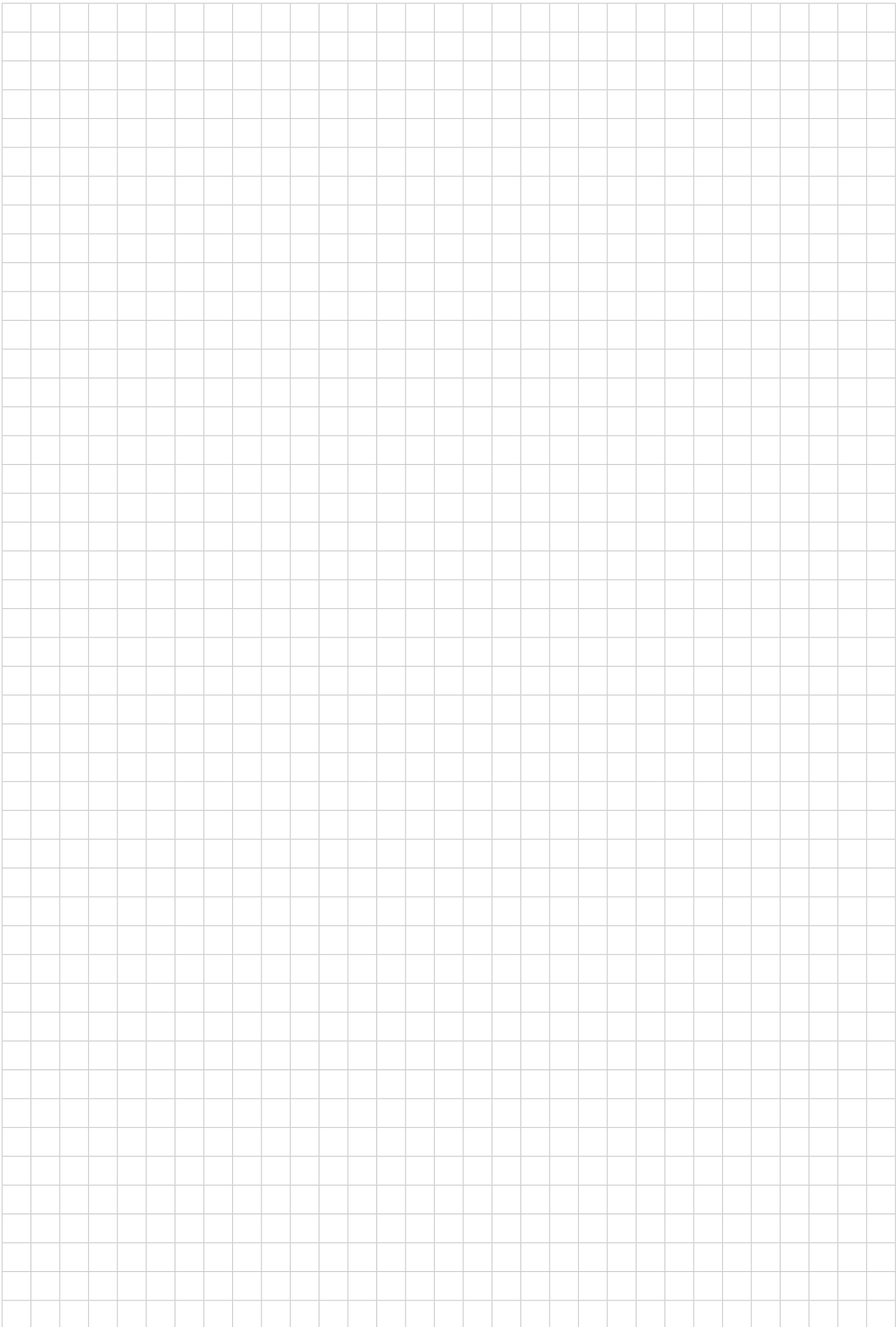

APEM

Switches & Pilot Lights

Control Boxes

Emergency Stop Switches

Enabling Switches

Safety Products

Explosion Proof

Terminal Blocks

Relays & Sockets

Circuit Protectors

Power Supplies

LED Illumination

Controllers

Operator Interfaces

Sensors

AUTO-ID

Interlock Switches

Coded Magnetic Switches

Safety Laser Scanners

Safety Light Curtains

Safety Modules

HS7A

HR1S

HS3A

HS7A-DMC Coded Magnetic Switches

Compact size and easy positioning.

Combination with proprietary relay modules achieves safety category 4 (EN ISO 13849-1).

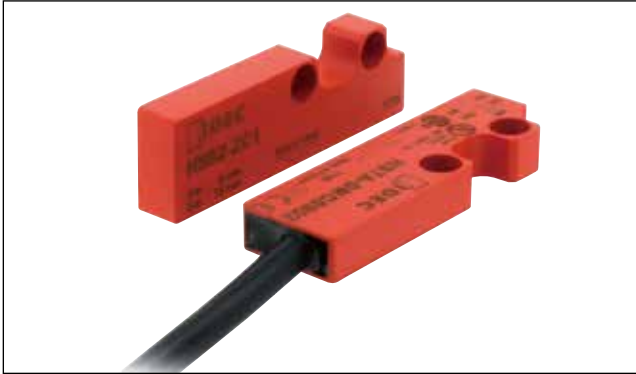

HS7A Coded Magnetic Switches

Contact Configuration	Cable Length	LED	Part No.	Applicable Safety Relay Module
1NO+1NC	2m	Without	HS7A-DMC5902	HR6S-AF1* HR6S-AK1* HR6S-AT1* HR6S-S1* HR6S-DN*
		With	HS7A-DMC5912	
	5m	Without	HS7A-DMC5905	
		With	HS7A-DMC5915	
	10m	Without	HS7A-DMC59010	
		With	HS7A-DMC59110	
2NO	2m	Without	HS7A-DMC7902	HR6S-AF1* HR6S-AK1* HR6S-AT1*
		With	HS7A-DMC7912	
	5m	Without	HS7A-DMC7905	
		With	HS7A-DMC7915	
	10m	Without	HS7A-DMC79010	
		With	HS7A-DMC79110	

*: C (Push-in), P (Screw)

- Package quantity: 1
- The HS7A-DMC coded magnetic switch is supplied with an HS9Z-ZC1 actuator.
- The contact configuration in the table above shows the contact status when the coded magnetic switch is not activated.

HR6S Safety Relay Modules for Coded Magnetic Switches

Safety Relay Module	Voltage	Number of Inputs
HS7A HR6S-S1C	24V AC -15 to +10% 50/60 Hz	2
HR6S-S1P		
HR6S-DN1C		
HR6S-DN1P	24V DC -20 to +20%	6
HR6S-AF1C		
HR6S-AF1P		

Accessory

Name	Part No.
Actuator	HS9Z-ZC1

- One HS9Z-ZC1 is supplied with each HS7A-DMC coded magnetic switch.

Specifications

Applicable Standards	IEC/EN 60947-5-1 UL508 (UL listed) CSA C22.2, No. 14	
Type and Coded level	Type 4 interlocking device / low level coded (EN ISO14119)	
Operating Temperature	-25 to +85°C (no freezing)	
Relative Humidity	30 to 85% RH (no condensation)	
Storage Temperature	-40 to +85°C (no freezing)	
Pollution Degree	3	
Electric Shock Protection	Class II (IEC 60536)	
Degree of Protection	IP67 (IEC 60529)	
Shock Resistance	300 m/s ² (11 ms) (IEC 60068-2-7)	
Vibration Resistance	100 m/s ² (10 to 150 Hz) (IEC 60068-2-6)	
Rated Voltage (Ue)	24V DC	
Rated Current (Ie)	100 mA	
Repeat Accuracy	10% maximum	
Maximum Operating Frequency	150 Hz	
Voltage Drop	I = 10 mA	0.1V (without LED) / 2.4V (with LED)
	I = 100 mA	1V (without LED) / 4.2V (with LED)
Housing Material	PBT	
Housing Color	Red	
Cable	AWG23 (0.25 mm ²) × 4 Cable length: 2m, 5m, 10m	
Weight (approx.)	HS7A-DMC: 100g (cable length: 2m) HS9Z-ZC1: 9g	

Dimensions

HS7A-DMC

(Coded Magnetic Switches)

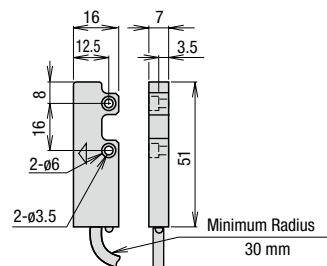

HS9Z-ZC1 (Actuator)

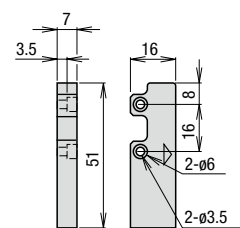

All dimensions in mm.

For the HR6S catalog, see below.

https://apac.idec.com/idec-apac/en/SGD/Safety-Components/Safety-Relay-Module/HR6S-Series/c/HR6S_Series

APEM

Switches & Pilot Lights

Control Boxes

Emergency Stop Switches

Enabling Switches

Safety Products

Explosion Proof

Terminal Blocks

Relays & Sockets

Circuit Protectors

Power Supplies

LED Illumination

Controllers

Operator Interfaces

Sensors

AUTO-ID

Interlock Switches

Coded Magnetic Switches

Safety Laser Scanners

Safety Light Curtains

Safety Modules

⚠ Safety Precautions

- In order to avoid electric shock or fire, turn power off before installation, removal, wire connection, maintenance, or inspection of the coded magnetic switch.

- Do not install the actuator in the location where the human body may come in contact. Otherwise injury may occur.

Instructions

- Safety category 4 (EN ISO 13849-1) can be achieved by combining the HS7A coded magnetic switch and HR6S safety relay module (monitor the dual contacts using the safety relay module).
- When using coded magnetic switches, combine with a proprietary safety relay module and confirm that the conformable safety category and the safety category (EN ISO 13849-1) required to the machinery have been achieved.
- Be sure to use the HS7A coded magnetic switch in combination with the proprietary actuator HS9Z-ZC1. Do not use other actuators.
- Do not install/remove the coded magnetic switch while the power is on. Coded magnetic switches have a built-in non-resettable short-circuit protection (fuse). By adding an external fuse (500mAgG) in series with each switch contact to avoid damage to the internal protection in case of misuse.
- Regardless of door types, do not use the coded magnetic switch as a door stop. Install a mechanical door stop on the edge of the door to protect the switch against excessive force.
- A shock to the door exceeding 300 m/s² (approx. 30G) may cause a failure to the switch.
- Do not store the coded magnetic switches in a dusty, humid, organic-gas atmosphere, or areas subject to direct sunlight.

Precaution for Cable Wiring

- ⚠ Tensile force on the cable may cause disconnection. Be sure to secure the cable near the coded magnetic switches.

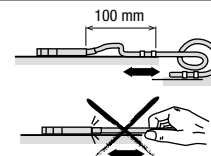

Precautions for Mounting the Actuator

- ⚠ Do not use the coded magnetic switch as a mechanical stop for movable guard.
- ⚠ Do not use a hammer to adjust a position of the coded magnetic switch.
- ⚠ Do not use the coded magnetic switch in a magnetic field of 0.3 mT or over.

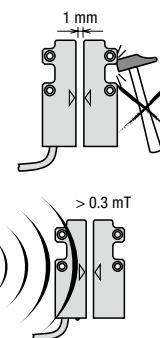

Operating Direction

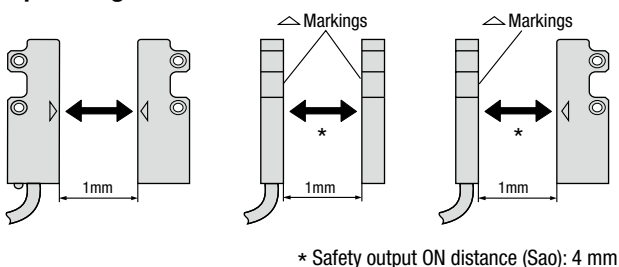

Operation Chart

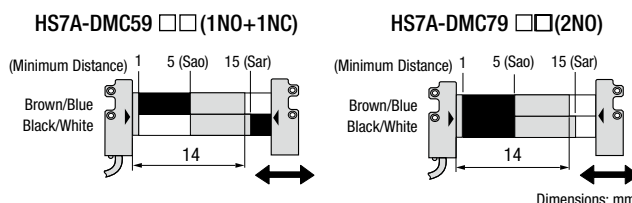

Contact Status

■	Contact Closed (1)
■	Contact Open (0)
■	Transient State

Sao: Assured operating distance where the safety output is sure to turn on.
 Sar: Assured release distance where the safety output is sure to turn off.

Note: When the transfer time between the actuator's Sao-Sar is 500 ms or longer, the time lag is detected as an error.

Precautions for Installation

When installing on a ferromagnet

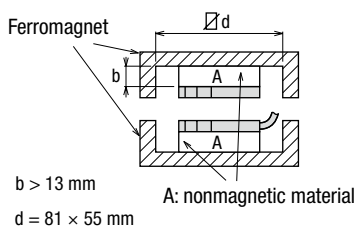

Close mounting

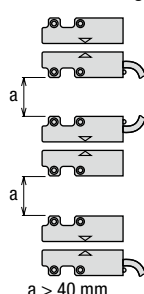

Tightening Torque

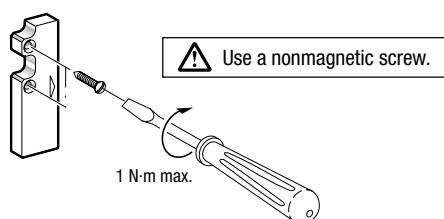

Operation Area

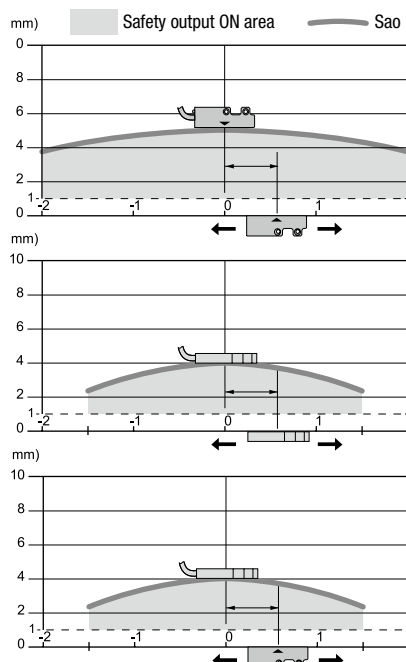

HS7A-DMP Coded Magnetic Switches (3-contact)



HR6S Safety Relay Modules for Coded Magnetic Switches

HS7A Coded Magnetic Switches

HS7A Coded Magnetic Switches

Contact Configuration	Cable Length	LED	Part No.	Applicable Safety Relay Module
1NO+2NC	2m	With	HS7A-DMP5012	HR6S-AF1*
		Without	HS7A-DMP5005	HR6S-AK1*
	5m	With	HS7A-DMP5015	HR6S-AT1*
2NO+1NC	2m	Without	HS7A-DMP7002	HR6S-S1*
		With	HS7A-DMP7012	HR6S-DN*
	5m	Without	HS7A-DMP7005	HR6S-AF1*
		With	HS7A-DMP7015	HR6S-AT1*

*: C (Push-in), P (Screw)

- Package quantity: 1
- The HS7A-DMP coded magnetic switch is supplied with an HS9Z-ZP1 actuator.
- The contact configuration in the table shows the contact status when the coded magnetic switch is not activated.

HR6S Safety Relay Module for Coded Magnetic Switches

Safety Relay Module	Number of Inputs
HR6S-S1C	2
HR6S-S1P	
HR6S-DN1C	6
HR6S-DN1P	
HR6S-AF1C	1
HR6S-AF1P	

Accessory

Name	Part No.
Actuator	HS9Z-ZP1

- One HS9Z-ZP1 is supplied with the HS7A-DMP coded magnetic switch.

Specifications

Applicable Standards	IEC/EN 60947-5-1 UL508 (UL listed) CSA C22.2, No. 14	
Type and Coded level	Type 4 interlocking device / low level coded (EN ISO14119)	
Operating Temperature	-25 to 85°C (no freezing)	
Relative Humidity	35 to 85% RH (no condensation)	
Storage Temperature	-40 to +85°C (no freezing)	
Pollution Degree	3	
Electric Shock Protection	Class II (IEC 60536)	
Degree of Protection	IP67 (IEC 60529)	
Shock Resistance	300 m/s ² (11 ms) (IEC 60068-2-7)	
Vibration Resistance	100 m/s ² (10 to 150 Hz) (IEC 60068-2-6)	
Rated Voltage (Ue)	24V DC	
Rated Current (Ie)	100 mA	
Repeat Accuracy	10% maximum	
Maximum Operating Frequency	150 Hz	
Voltage Drop	I = 10 mA	0.1V (without LED), 2.4V (with LED)
	I = 100 mA	1V (without LED), 4.2V (with LED)
Electrical Durability	1,200,000 operations minimum	
Housing Material	PBT	
Housing Color	Red	
Cable	AWG23 (0.25 mm ²) × 6 Cable length: 2m, 5m	
Weight (approx.)	HS7A-DMP: 180g (cable length: 2 m) HS9Z-ZP1: 50g	

Dimensions

HS7A-DMP□□□□ (Coded Magnetic Switch)

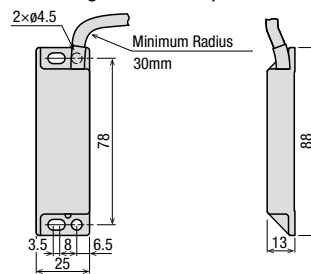

HS9Z-ZP1 (Actuator)

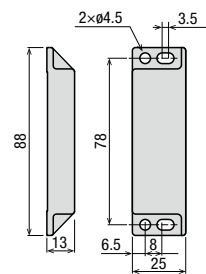

All dimensions in mm.

For the HR6S catalog, see below.

https://apac.idec.com/idec-apac/en/SGD/Safety-Components/Safety-Relay-Module/HR6S-Series/c/HR6S_Series

Wiring Diagram

⚠ The following diagrams show the contact statuses when the coded magnetic switches are activated by the actuators. Below are examples of wiring diagrams.

Category 4, PL= e (EN ISO 13849-1) / SIL3 circuit example

When using HR6S-S1 + HS7A-DMP50 (NC+NC+NO) + HS9Z-ZP1

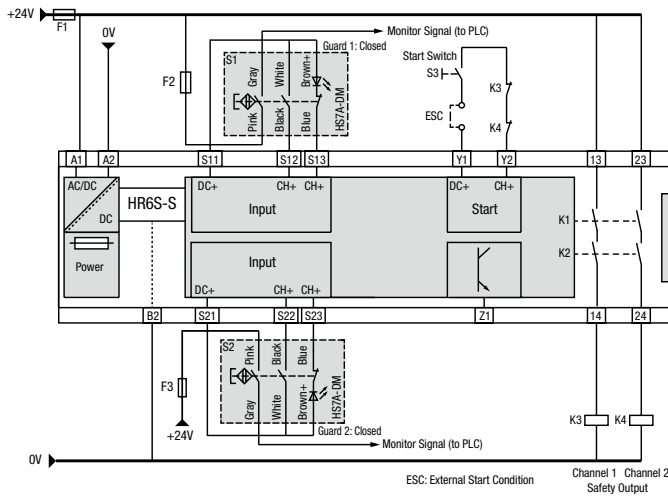

Category 4, PL= e (EN ISO 13849-1) / SIL3 circuit example

When using HR6S-DN1 + HS7A-DMP50 (NC+NC+NO) + HS9Z-ZP1

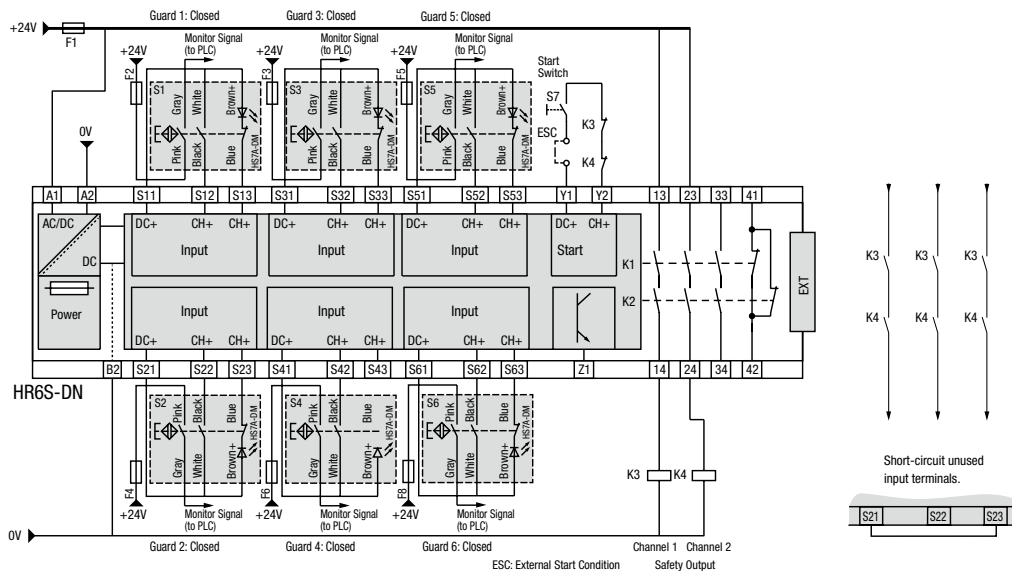

Category 4, PL= e (EN ISO 13849-1) / SIL3 circuit example

When using HR6S-AF1 + HS7A-DMP70 (NO+NO+NC) + HS9Z-ZP1

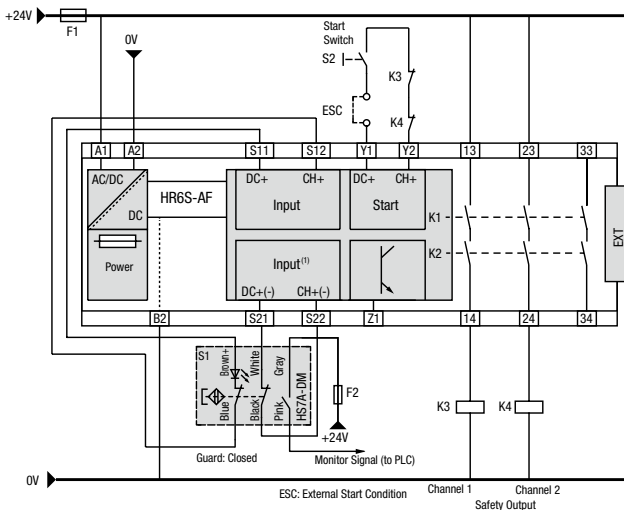

Note: The circuit example of HR6S and HS7A-DMP70 may not satisfy Category 4 depending on the operating condition.

Contact IDEC for details.

- APEM
- Switches & Pilot Lights
- Control Boxes
- Emergency Stop Switches
- Enabling Switches
- Safety Products
- Explosion Proof
- Terminal Blocks
- Relays & Sockets
- Circuit Protectors
- Power Supplies
- LED Illumination
- Controllers
- Operator Interfaces
- Sensors
- AUTO-ID
- Interlock Switches
- Coded Magnetic Switches
- Safety Laser Scanners
- Safety Light Curtains
- Safety Modules

HS7A

HR1S

HS3A

HS7A-DMP Coded Magnetic Switches (3-contact)

Safety Precautions

- In order to avoid electric shock or fire, turn the power off before installation, removal, wire connection, maintenance, or inspection of the coded magnetic switch.
- Do not install the actuator in the location where the human body may come in contact. Otherwise injury may occur.

Instructions

- Safety category 4 (EN ISO 13849-1) can be achieved by combining the HS7A coded magnetic switch and HR6S safety relay module (monitor the dual contacts using the safety relay module).
- When using coded magnetic switches, combine with a proprietary safety relay module and confirm that the conformable safety category and the safety category (EN ISO 13849-1) required to the machinery have been achieved.
- Be sure to use the HS7A coded magnetic switch in combination with the proprietary actuator HS9Z-ZP1. Do not use other actuators.
- Do not install/remove the coded magnetic switch while the power is on. Coded magnetic switches have a built-in non-resettable short-circuit protection (fuse). By adding an external fuse (500mA) in series with each switch contact to avoid damage to the internal protection in case of misuse.
- Regardless of door types, do not use the coded magnetic switch as a door stop. Install a mechanical door stop on the edge of the door to protect against excessive force.
- A shock to the door exceeding 300 m/s² (approx. 30G) may cause a failure to the coded magnetic switches.
- Do not store the switches in a dusty, humid, organic-gas atmosphere, or areas subject to direct sunlight.

Operating Direction

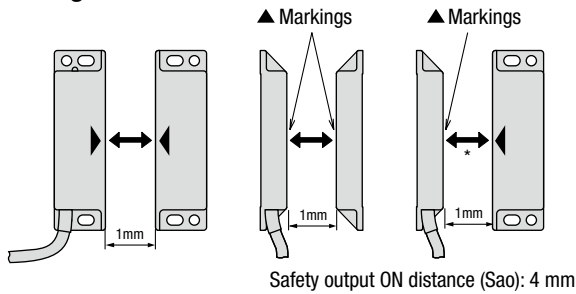

Precautions for Installation

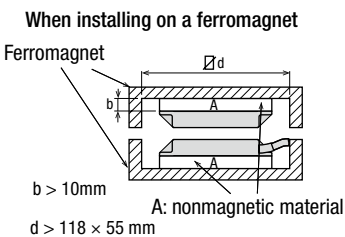

Close mounting

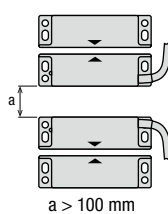

Tightening Torque

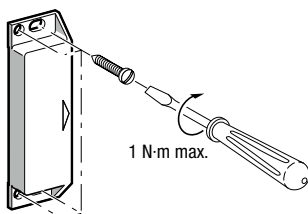

 Use a nonmagnetic screw.

Precaution for Cable Wiring

- ⚠ Tensile force on the cable may cause disconnection. Be sure to secure the cable near the coded magnetic switch.

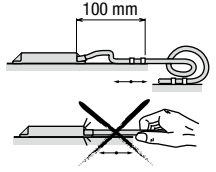

Precautions for Mounting Actuator

- ⚠ Do not use the coded magnetic switch as a mechanical stop for the movable guard.
- ⚠ Do not use a hammer to adjust the position of coded magnetic switch.

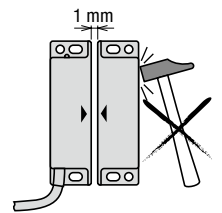

- ⚠ Do not use the coded magnetic switch in a magnetic field of 0.3 mT or over.

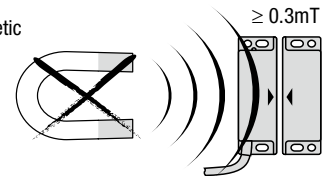

Operation Chart

HS7A-DMP50 □□ (1NO+2NC)

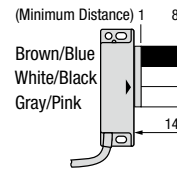

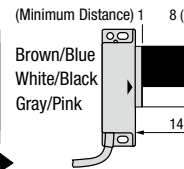

HS7A-DMP70 □□ (2NO+1NC)



Dimensions: mm

Contact Status

	Contact closed (1)
	Contact open (0)
	Transient area

Sao: Assured operating distance where the safety output is sure to turn on.
Sar: Assured release distance when the safety output is sure to turn off.

Note: When the transfer time between the actuator's Sao-Sar is 500 ms or longer, the time lag is detected as an error.

Operation Area

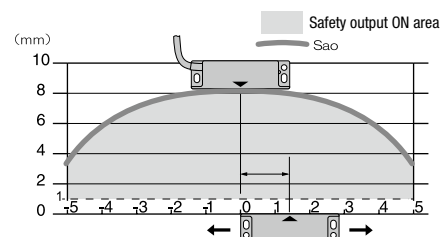

Ordering Terms and Conditions

Thank you for using IDEC Products.

By purchasing products listed in our catalogs, datasheets, and the like (hereinafter referred to as "Catalogs") you agree to be bound by these terms and conditions. Please read and agree to the terms and conditions before placing your order.

1. Notes on contents of Catalogs

- (1) Rated values, performance values, and specification values of IDEC products listed in this Catalog are values acquired under respective conditions in independent testing, and do not guarantee values gained in combined conditions.
Also, durability varies depending on the usage environment and usage conditions.
- (2) Reference data and reference values listed in Catalogs are for reference purposes only, and do not guarantee that the product will always operate appropriately in that range.
- (3) The specifications / appearance and accessories of IDEC products listed in Catalogs are subject to change or termination of sales without notice, for improvement or other reasons.
- (4) The content of Catalogs is subject to change without notice.

2. Note on applications

- (1) If using IDEC products in combination with other products, confirm the applicable laws / regulations and standards.
Also, confirm that IDEC products are compatible with your systems, machines, devices, and the like by using under the actual conditions. IDEC shall bear no liability whatsoever regarding the compatibility with IDEC products.
- (2) The usage examples and application examples listed in Catalogs are for reference purposes only. Therefore, when introducing a product, confirm the performance and safety of the instruments, devices, and the like before use. Furthermore, regarding these examples, IDEC does not grant license to use IDEC products to you, and IDEC offers no warranties regarding the ownership of intellectual property rights or non-infringement upon the intellectual property rights of third parties.
- (3) When using IDEC products, be cautious when implementing the following.
 - i. Use of IDEC products with sufficient allowance for rating and performance
 - ii. Safety design, including redundant design and malfunction prevention design that prevents other danger and damage even in the event that an IDEC product fails
 - iii. Wiring and installation that ensures the IDEC product used in your system, machine, device, or the like can perform and function according to its specifications
- (4) Continuing to use an IDEC product even after the performance has deteriorated can result in abnormal heat, smoke, fires, and the like due to insulation deterioration or the like. Perform periodic maintenance for IDEC products and the systems, machines, devices, and the like in which they are used.
- (5) IDEC products are developed and manufactured as general-purpose products for general industrial products. They are not intended for use in the following applications, and in the event that you use an IDEC product for these applications, unless otherwise agreed upon between you and IDEC, IDEC shall provide no guarantees whatsoever regarding IDEC products.
 - i. Use in applications that require a high degree of safety, including nuclear power control equipment, transportation equipment (railroads / airplanes / ships / vehicles / vehicle instruments, etc.), equipment for use in outer space, elevating equipment, medical instruments, safety devices, or any other equipment, instruments, or the like that could endanger life or human health
 - ii. Use in applications that require a high degree of reliability, such as provision systems for gas / waterworks / electricity, etc., systems that operate continuously for 24 hours, and settlement systems
 - iii. Use in applications where the product may be handled or used deviating from the specifications or conditions / environment listed in the Catalogs, such as equipment used outdoors or applications in environments subject to chemical pollution or electromagnetic interference
If you would like to use IDEC products in the above applications, be sure to consult with an IDEC sales representative.

3. Inspections

We ask that you implement inspections for IDEC products you purchase without delay, as well as thoroughly keep in mind management/maintenance regarding handling of the product before and during the inspection.

4. Warranty

- (1) Warranty period
The warranty period for IDEC products shall be one (1) year after purchase or delivery to the specified location. However, this shall not apply in cases where there is a different specification in the Catalogs or there is another agreement in place between you and IDEC.
- (2) Warranty scope
Should a failure occur in an IDEC product during the above warranty period for reasons attributable to IDEC, then IDEC shall replace or repair that product, free of charge, at the purchase location / delivery location of the product, or an IDEC service base. However, failures caused by the following reasons shall be deemed outside the scope of this warranty.
 - i. The product was handled or used deviating from the conditions / environment listed in the Catalogs
 - ii. The failure was caused by reasons other than an IDEC product
 - iii. Modification or repair was performed by a party other than IDEC
 - iv. The failure was caused by a software program of a party other than IDEC
 - v. The product was used outside of its original purpose
 - vi. Replacement of maintenance parts, installation of accessories, or the like was not performed properly in accordance with the user's manual and Catalogs
 - vii. The failure could not have been predicted with the scientific and technical standards at the time when the product was shipped from IDEC
 - viii. The failure was due to other causes not attributable to IDEC (including cases of force majeure such as natural disasters and other disasters)Furthermore, the warranty described here refers to a warranty on the IDEC product as a unit, and damages induced by the failure of an IDEC product are excluded from this warranty.

5. Limitation of liability

The warranty listed in this Agreement is the full and complete warranty for IDEC products, and IDEC shall bear no liability whatsoever regarding special damages, indirect damages, incidental damages, or passive damages that occurred due to an IDEC product.

6. Service scope

The prices of IDEC products do not include the cost of services, such as dispatching technicians. Therefore, separate fees are required in the following cases.

- (1) Instructions for installation / adjustment and accompaniment at test operation (including creating application software and testing operation, etc.)
- (2) Maintenance inspections, adjustments, and repairs
- (3) Technical instructions and technical training
- (4) Product tests or inspections specified by you

The above content assumes transactions and usage within your region. Please consult with an IDEC sales representative regarding transactions and usage outside of your region. Also, IDEC provides no guarantees whatsoever regarding IDEC products sold outside your region.

IDEC CORPORATION

Head Office 6-64, Nishi-Miyahara-2-Chome, Yodogawa-ku, Osaka 532-0004, Japan

USA IDEC Corporation
EMEA APEM SAS

Singapore IDEC Izumi Asia Pte. Ltd.
Thailand IDEC Asia (Thailand) Co., Ltd.
India IDEC Controls India Private Ltd.

China IDEC (Shanghai) Corporation
IDEC Izumi (H.K.) Co., Ltd.
Taiwan IDEC Taiwan Corporation

 www.idec.com

Japan IDEC Corporation

Specifications and other descriptions in this brochure are subject to change without notice.

2023 IDEC Corporation, All Rights Reserved.



X-ON Electronics

Largest Supplier of Electrical and Electronic Components

Click to view similar products for [Magnetic/Reed Switches](#) category:

Click to view products by [Idec](#) manufacturer:

Other Similar products are found below :

[AMS-20MG](#) [AMS-37-G_W/Brk](#) [AMS-38S-I](#) [AMS-39B-W](#) [AMS-10S-B](#) [AMS-37BROWN](#) [AMS-38MG](#) [AMS-38SB](#) [AMS-9-B](#) [AMS-T10C\(B\)](#) [4350238](#) [505-171W WHITE](#) [505-211B](#) [505-391G](#) [505-70B](#) [507-382B](#) [BMC-33B](#) [HM00-01800](#) [505-101BC](#) [505-101-GC](#) [505-101-WS](#) [505-172W](#) [505-201W](#) [505-392W](#) [505-5114B BROWN](#) [505-90G](#) [505-90I](#) [507-381BB](#) [RSW-21A-I](#) [TSW-2T](#) [AMS-10MGW](#) [AMS-37B GRAY](#) [HM00-01608LF](#) [HM00-04603LF](#) [HM00-02441BLFTR](#) [XCSDMP790L01M12](#) [HS7A-DMC7915](#) [KSK-1A66-2030](#) [44531-0200](#) [44531-0710](#) [MK28-1A-500W](#) [MK28-1B-500W](#) [35-756](#) [D40MLCBLM1210M](#) [D40MLCBLM125M](#) [D40PBPC2105](#) [D40PSPC2105](#) [KSK-1A52-1520](#) [KSK-1A87-2025](#) [KSK-1C90U-1530](#)