

HS6E Subminiature Interlock Switches with Solenoid

Key features:

- Compact body: 75 × 15 × 75mm
15mm wide, thinnest solenoid interlock switch in the world
- Reversible mounting and angled cable allow four actuator insertion directions
- Energy saving: 24V DC, 110mA (solenoid: 100mA, LED: 10mA)
- Manual unlocking possible on three sides
- LED indicator shows solenoid operation
- 500N locking retention force

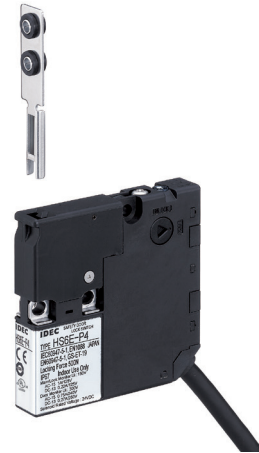

Part Numbers

Mechanical Spring Lock (power solenoid to unlock)		
Contact Configuration	Cable Length	Part Number
(Actuator inserted) (Solenoid OFF)		
Main Circuit: 11 12 41 42 Monitor Circuit: 21 22 53 54 Monitor Circuit: 31 32	1m 3m 5m	HS6E-L44B01-G HS6E-L44B03-G HS6E-L44B05-G
Main Circuit: 11 12 41 42 Monitor Circuit: 21 22 51 52 Monitor Circuit: 31 32	1m 3m 5m	HS6E-M44B01-G HS6E-M44B03-G HS6E-M44B05-G
Main Circuit: 11 12 41 42 Monitor Circuit: 21 22 53 54 Monitor Circuit: 33 34	1m 3m 5m	HS6E-N44B01-G HS6E-N44B03-G HS6E-N44B05-G
Main Circuit: 11 12 41 42 Monitor Circuit: 21 22 51 52 Monitor Circuit: 33 34	1m 3m 5m	HS6E-P44B01-G HS6E-P44B03-G HS6E-P44B05-G

Solenoid Lock (remove power to solenoid to unlock)		
Contact Configuration	Cable Length	Part Number
(Actuator inserted) (Solenoid ON)		
Main Circuit: 11 12 41 42 Monitor Circuit: 21 22 53 54 Monitor Circuit: 31 32	1m 3m 5m	HS6E-L7Y4B01-G HS6E-L7Y4B03-G HS6E-L7Y4B05-G
Main Circuit: 11 12 41 42 Monitor Circuit: 21 22 51 52 Monitor Circuit: 31 32	1m 3m 5m	HS6E-M7Y4B01-G HS6E-M7Y4B03-G HS6E-M7Y4B05-G
Main Circuit: 11 12 41 42 Monitor Circuit: 21 22 53 54 Monitor Circuit: 33 34	1m 3m 5m	HS6E-N7Y4B01-G HS6E-N7Y4B03-G HS6E-N7Y4B05-G
Main Circuit: 11 12 41 42 Monitor Circuit: 21 22 51 52 Monitor Circuit: 33 34	1m 3m 5m	HS6E-P7Y4B01-G HS6E-P7Y4B03-G HS6E-P7Y4B05-G

1. Contact configuration shows the contact status when actuator is inserted and solenoid off for spring lock.
2. Contact configuration shows the contact status when actuator is inserted and solenoid on for solenoid lock.
3. Indicator LED color is green.
4. Actuator keys are not supplied with the interlock switch and must be ordered separately.
5. Manual unlock key is included with the interlock switch.
6. Standard stock items in bold.

Overview

XW Series E-Stops

Interlock Switches





Enabling Switches

Safety Control Relays

Light Curtains

AS-Interface Safety at Work

Actuator Keys

Appearance	Item	Ordering Part Number	Remarks
	Straight Actuator	HS9Z-A61	The retention force of HS9Z-A61 actuator is 500N maximum. Do not apply excessive load.
	Right-angle Actuator	HS9Z-A62	The retention force of HS9Z-A62 actuator is 100N maximum. Do not apply excessive load. When retention force of 100N or more is required, use the HS9Z-A62S actuator.
	Right-angle Actuator with Mounting Plate	HS9Z-A62S	The retention force of HS9Z-A62S actuator is 500N maximum. Do not apply excessive load.
	Horizontal/Vertical Angle Adjustable Actuator	HS9Z-A65	The HS9Z-A65 and HS9Z-A66 have their metal actuator installed in opposite directions. Select actuator by determining the required moving direction in consideration of the door and interlock switch. See page 320 for more information. The retention force of HS9Z-A65 and HS9Z-A66 500N maximum.
	Horizontal/Vertical Angle Adjustable Actuator	HS9Z-A66	

Specifications

Conforming to Standards	UL 508 (UL listed), CSA C22.2, No. 14 (c-UL listed), ISO 14119 IEC 60947-5-1, EN 60947-5-1 (TÜV approval), EN 1088 (TÜV approval), GS-ET-19 IEC 60204-1/EN 60204-1 (applicable standards for use)	
Operating Temperature	-25 to +50°C (no freezing)	
Storage Temperature	-40 to +80°C (no freezing)	
Operating Humidity	45 to 85% (no condensation)	
Rated Insulation Voltage (U _i)	300V (between LED and ground: 60V)	
Impulse Withstand Voltage (U _{imp})	Main & lock monitor circuits: 1.5 kV Door monitor circuit: 2.5 kV Between solenoid/LED and ground: 0.5 kV	
Insulation Resistance (500V DC megger)	Between live and dead metal parts: 100 MΩ minimum Between terminals of different poles: 100 MΩ minimum.	
Contact Resistance	300 mΩ maximum (initial value, 1m cable) 500 mΩ maximum (initial value, 3m cable) 700 mΩ maximum (initial value, 5m cable)	
Electric Shock Protection Class	Class II (IEC 61140)	
Pollution Degree	3	
Degree of Protection	IP67 (IEC 60529)	
Vibration Resistance	Operating Extremes	10 to 55 Hz, amplitude 0.35mm
	Damage Limits	30 Hz, amplitude 1.5 mm
Shock Resistance	Operating Extremes	100 m/s ² (10G)
	Damage Limits	1000 m/s ² (100G)
Actuator Operating Speed	0.05 to 1.0 m/s	
Direct Opening Travel	8.0 mm minimum	
Direct Opening Force	60N minimum	
Actuator Retention Force	500N maximum (GS-ET-19)	
Operating Frequency	900 operations/hour	
Mechanical Life	1,000,000 operations minimum (GS-ET-19)	

Electrical Life	100,000 operations minimum (rated load) 1,000,000 operations minimum (24V AC/DC, 100 mA) (operating frequency 900 operations/hr)
Conditional Short-circuit Current	50A (250V) (Use 250V/10A fast-blow fuse for short-circuit protection.)
Cable	22 AWG (12-core: 0.3 mm ² or equivalent/core)
Cable Diameter	ø7.6 mm
Weight	Approx. 200g

- 1. UL, c-UL rating: Main/Lock monitor circuit: 125V AC, 1A Pilot duty, 125V DC, 0.22A Pilot duty
Door monitor circuit: 240V AC, 0.75A Pilot duty/250V DC, 0.27A Pilot duty
- 2. TÜV rating: Main/Lock monitor circuit: AC-15 125V/1A, DC-13 125V/0.22A
Door monitor circuit: AC-15 240V/0.75A, DC-13 250V/0.27A

Solenoid/Indicator

Locking Mechanism	Spring Lock Type or Solenoid Lock Type	
Rated Voltage	24V DC	
Current	110 mA (solenoid 100 mA, LED 10 mA)	
Solenoid	Coil Resistance	240Ω (at 20°C)
	Pickup Voltage	Rated voltage × 85% maximum (at 20°C)
	Dropout Voltage	Rated voltage × 10% minimum (at 20°C)
	Maximum Continuous Applicable Voltage	Rated voltage × 110%
	Maximum Continuous Applicable Time	Continuous
	Insulation Class	Class F
Indicator	Light Source	LED
	Illumination Color	Green

Contact Ratings

Rated Operating Current (I _e)	Operating Voltage (U _e)		30V	125V	250V
	Main and Lock Monitor Circuits	AC	Resistive load (AC-12)	–	2A
Inductive load (AC-15)			–	1A	–
DC		Resistive load (DC-12)	2A	0.4A	–
		Inductive load (DC-13)	1A	0.22A	–
Door Monitor Circuit	AC	Resistive load (AC-12)	–	2.5A	1.5A
		Inductive load (AC-15)	–	1.5A	0.75A
	DC	Resistive load (DC-12)	2.5A	1.1A	0.55A
		Inductive load (DC-13)	2.3A	0.55A	0.27A

- 1. UL, c-UL rating: Main/Lock monitor circuit: 125V AC, 1A Pilot duty, 125V DC, 0.22A Pilot duty
Door monitor circuit: 240V AC, 0.75A Pilot duty/250V DC, 0.27A Pilot duty
- 2. TÜV rating: Main/Lock monitor circuit: AC-15 125V/1A, DC-13 125V/0.22A
Door monitor circuit: AC-15 240V/0.75A, DC-13 250V/0.27A

Dimensions (mm)

Interlock Switch

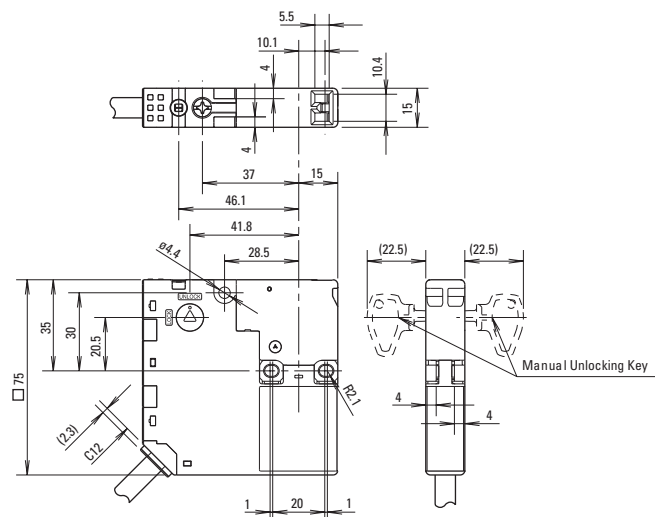

Mounting Hole Layout

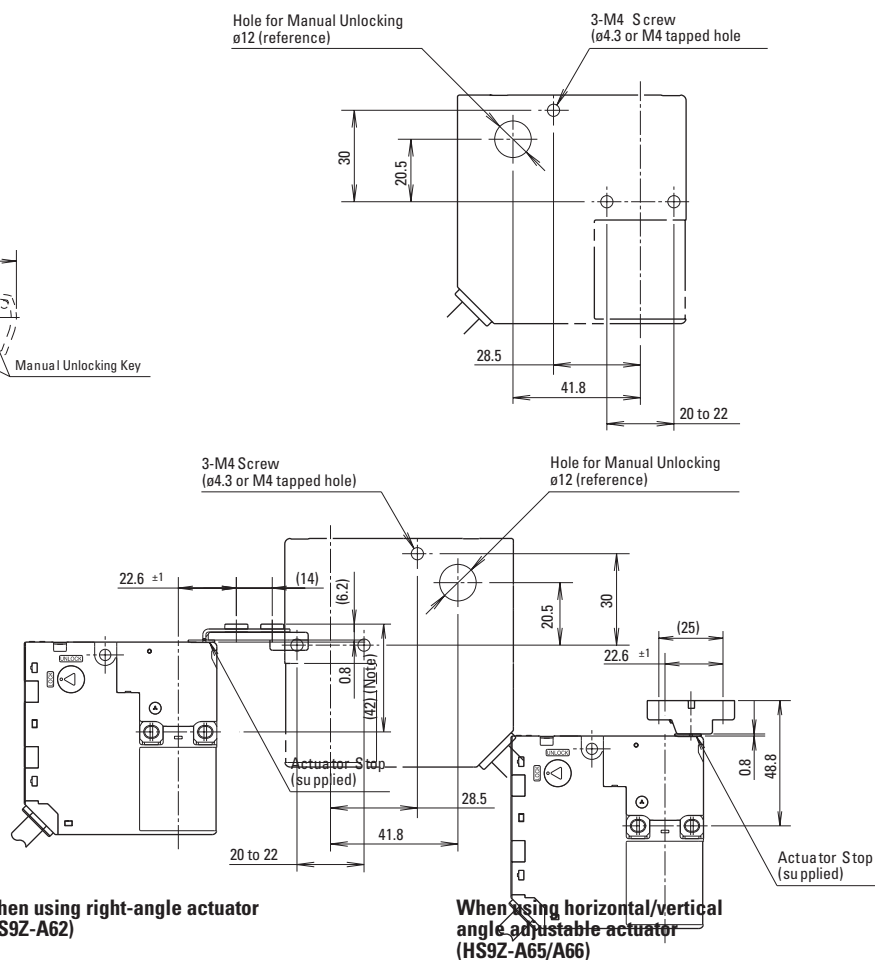

When using straight actuator (HS9Z-A61)

When using right-angle actuator (HS9Z-A62)

When using horizontal/vertical angle adjustable actuator (HS9Z-A65/A66)

Actuator Mounting Reference Position

As shown in the figure on the right, the mounting reference position of the actuator key when inserted in the interlock switch is:

The actuator stop on the actuator lightly touches the interlock switch.



After mounting the actuator, remove the actuator stop from the actuator.

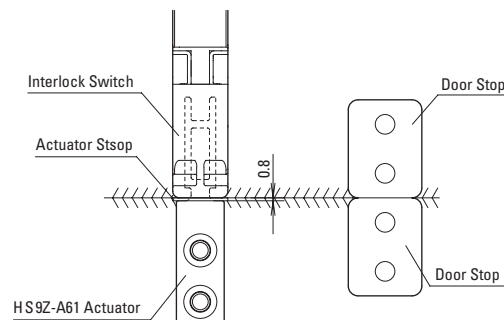

Actuator Key Dimensions (mm)

Straight Actuator (HS9Z-A61)

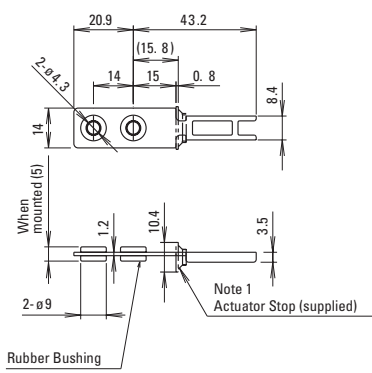

Straight Actuator (HS9Z-A61) Right-angle Actuator (HS9Z-A62)

The retention force of the HS9Z-A62 actuator is 100N. When tensile force exceeding 100N is expected, use the HS9Z-A62S actuator.

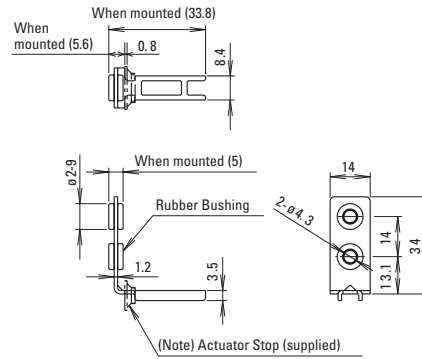

Right-angle Actuator with Mounting Plate (HS9Z-A62S)

Note: See page 323 for actuator installation.

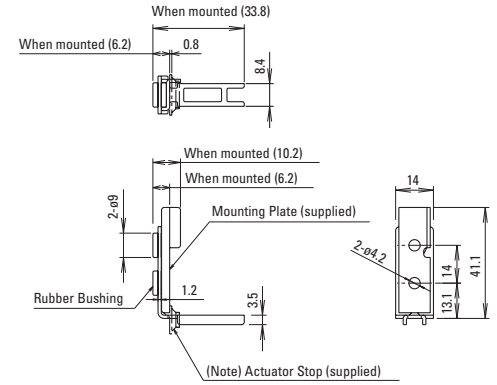

Overview

XW Series E-Stops

Interlock Switches

Enabling Switches

Safety Control Relays

Light Curtains

AS-Interface Safety at Work

The actuator stop is used to adjust the actuator position. Remove after the actuator position is mounted.

Angle Adjustable Actuator (HS9Z-A65)

Horizontal Adjustment

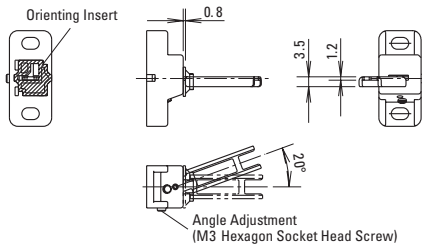

Vertical Adjustment

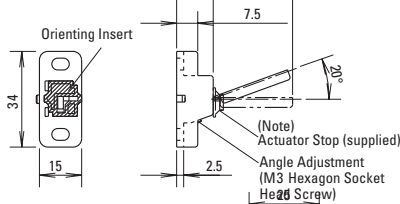

Angle Adjustable Actuator (HS9Z-A66)

(M3 or M4 tapping screw)

Angle Adjustable Actuator (HS9Z-A66)

The HS9Z-A65 and HS9Z-A66 have the metal actuator inserted in opposite directions.

Horizontal Adjustment

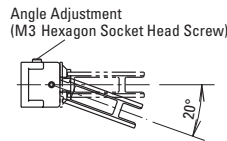

Vertical Adjustment

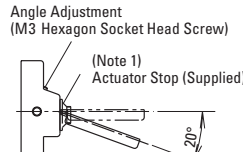

Manual Unlock Key (plastic)

(supplied with switch, not replaceable)

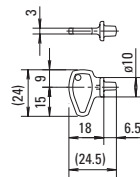

Actuator Adjustment Orientation

The orientation of actuator adjustment (horizontal/vertical) can be changed using the orienting insert (white plastic) installed on the back of the actuator.

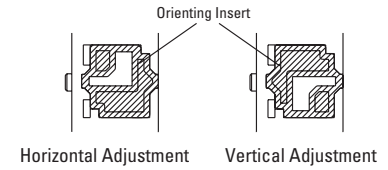

Manual Unlock Key, HS9Z-T3 (metal)

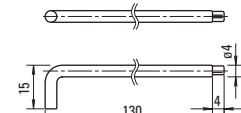

Circuit Diagrams and Operating Characteristics

Spring Lock Type

	Status 1	Status 2	Status 3	Status 4	Unlocking Using Manual Unlock Key
Interlock Switch Status	Door closed Machine ready to operate Solenoid de-energized	Door opened Machine cannot be operated Solenoid energized	Door open Machine cannot be operated Solenoid energized	Door open Machine cannot be operated Solenoid de-energized	Door closed Machine cannot be operated Solenoid de-energized
Door Status					
Circuit Diagram (Example: HS6E-N4)					

Door		Closed (locked)	Closed (unlocked)	Open	Open	Closed (unlocked)	
Part Number and Circuit Diagram	HS6E-L4 Main Circuit: 11-12, 41-42 Monitor Circuit: 21-22, 53-54 Lock Monitor Circuit: 31-32	Main Circuit 11-42	ON (closed)	OFF (open)	OFF (open)	OFF (open)	
		Door Monitor Circuit (door closed) 21-22	ON (closed)	ON (closed)	OFF (open)	OFF (open)	ON (closed)
		Door Monitor Circuit (door closed) 31-32	ON (closed)	ON (closed)	OFF (open)	OFF (open)	ON (closed)
		Lock Monitor Circuit (unlocked) 53-54	OFF (open)	ON (closed)	ON (closed)	ON (closed)	ON (closed)
	HS6E-M4 Main Circuit: 11-12, 41-42 Monitor Circuit: 21-22, 51-52 Lock Monitor Circuit: 31-32	Main Circuit 11-42	ON (closed)	OFF (open)	OFF (open)	OFF (open)	OFF (open)
		Door Monitor Circuit (door closed) 21-22	ON (closed)	ON (closed)	OFF (open)	OFF (open)	ON (closed)
		Door Monitor Circuit (door closed) 31-32	ON (closed)	ON (closed)	OFF (open)	OFF (open)	ON (closed)
		Lock Monitor Circuit (locked) 51-52	ON (closed)	OFF (open)	OFF (open)	OFF (open)	OFF (open)
	HS6E-N4 Main Circuit: 11-12, 41-42 Monitor Circuit: 21-22, 53-54 Lock Monitor Circuit: 33-34	Main Circuit 11-42	ON (closed)	OFF (open)	OFF (open)	OFF (open)	OFF (open)
		Door Monitor Circuit (door closed) 21-22	ON (closed)	ON (closed)	OFF (open)	OFF (open)	ON (closed)
		Door Monitor Circuit (door open) 33-34	OFF (open)	OFF (open)	ON (closed)	ON (closed)	OFF (open)
		Lock Monitor Circuit (unlocked) 53-54	OFF (open)	ON (closed)	ON (closed)	ON (closed)	ON (closed)
	HS6E-P4 Main Circuit: 11-12, 41-42 Monitor Circuit: 21-22, 51-52 Lock Monitor Circuit: 33-34	Main Circuit 11-42	ON (closed)	OFF (open)	OFF (open)	OFF (open)	OFF (open)
		Door Monitor Circuit (door closed) 21-22	ON (closed)	ON (closed)	OFF (open)	OFF (open)	ON (closed)
		Door Monitor Circuit (door open) 33-34	OFF (open)	OFF (open)	ON (closed)	ON (closed)	OFF (open)
		Lock Monitor Circuit (locked) 51-52	ON (closed)	OFF (open)	OFF (open)	OFF (open)	OFF (open)
Solenoid Power A1-A2 (all types)		OFF (de-energized)	ON (energized)	ON (energized)	OFF (de-energized)	OFF (de-energized)	

Main circuit: Connected to the machine drive control circuit, sending the interlock signals of the protective door.
 Monitor circuit: Sends the monitoring signals of open/closed and lock/unlocked statuses of the protective door.

Operation Characteristics (reference)

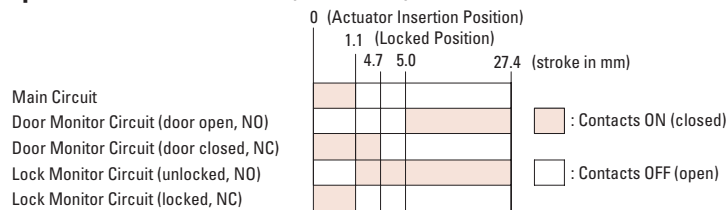

The characteristics shown in the chart above are of the HS9Z-A61, -A62, -A65, and -A66 actuators. For the HS9Z-A62S actuator, subtract 0.6 mm. The characteristics show the contact status when the actuator enters an entry slot of an interlock switch.

Overview

XW Series E-Stops

Interlock Switches

Enabling Switches

Safety Control Relays

Light Curtains

AS-Interface Safety at Work

Solenoid Lock Type		Status 1	Status 2	Status 3	Status 4	Unlocking Using Manual Unlock Key	
Interlock Switch Status		Door closed Machine ready to operate Solenoid energized	Door closed Machine cannot be operated Solenoid de-energized	Door open Machine cannot be operated Solenoid de-energized	Door open Machine cannot be operated Solenoid de-energized	Door open Machine cannot be operated Solenoid de-energized	
Door Status							
Circuit Diagram (Example: HS6E-N7Y)							
Door		Closed (locked)	Closed (unlocked)	Open	Open	Closed (unlocked)	
Part Number and Circuit Diagram	HS6E-L7Y 	Main Circuit 11-42	ON (closed)	OFF (open)	OFF (open)	OFF (open)	OFF (open)
		Door Monitor Circuit (door closed) 21-22	ON (closed)	ON (closed)	OFF (open)	OFF (open)	ON (closed)
		Door Monitor Circuit (door closed) 31-32	ON (closed)	ON (closed)	OFF (open)	OFF (open)	ON (closed)
		Lock Monitor Circuit (unlocked) 53-54	OFF (open)	ON (closed)	ON (closed)	ON (closed)	ON (closed)
	HS6E-M7Y 	Main Circuit 11-42	ON (closed)	OFF (open)	OFF (open)	OFF (open)	OFF (open)
		Door Monitor Circuit (door closed) 21-22	ON (closed)	ON (closed)	OFF (open)	OFF (open)	ON (closed)
		Door Monitor Circuit (door closed) 31-32	ON (closed)	ON (closed)	OFF (open)	OFF (open)	ON (closed)
		Lock Monitor Circuit (locked) 51-52	ON (closed)	OFF (open)	OFF (open)	OFF (open)	OFF (open)
	HS6E-N7Y 	Main Circuit 11-42	ON (closed)	OFF (open)	OFF (open)	OFF (open)	OFF (open)
		Door Monitor Circuit (door closed) 21-22	ON (closed)	ON (closed)	OFF (open)	OFF (open)	ON (closed)
		Door Monitor Circuit (door open) 33-34	OFF (open)	OFF (open)	ON (closed)	ON (closed)	OFF (open)
		Lock Monitor Circuit (unlocked) 53-54	OFF (open)	ON (closed)	ON (closed)	ON (closed)	ON (closed)
HS6E-P7Y 	Main Circuit 11-42	ON (closed)	OFF (open)	OFF (open)	OFF (open)	OFF (open)	
	Door Monitor Circuit (door closed) 21-22	ON (closed)	ON (closed)	OFF (open)	OFF (open)	ON (closed)	
	Door Monitor Circuit (door open) 33-34	OFF (open)	OFF (open)	ON (closed)	ON (closed)	OFF (open)	
	Lock Monitor Circuit (locked) 51-52	ON (closed)	OFF (open)	OFF (open)	OFF (open)	OFF (open)	
Solenoid Power A1-A2 (all types)		ON (energized)	OFF (de-energized)	OFF (de-energized)	ON (energized) (Note 2)	OFF (de-energized) to ON (re-energized) (Note 1) (Note 2)	



Main circuit: Connected to the machine drive control circuit, sending the interlock signals of the protective door.
Monitor circuit: Sends the monitoring signals of open/closed and lock/unlocked statuses of the protective door.

Note 1: Do not attempt manual unlocking while the solenoid is energized.
Note 2: Do not energize the solenoid for a long period of time while the door is open or while the door is unlocked manually using the manual unlock key.

Operation Characteristics (reference)

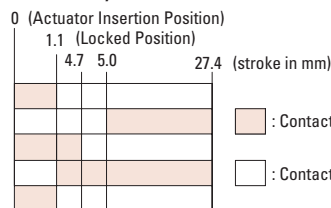

Main Circuit
Door Monitor Circuit (door open, NO)
Door Monitor Circuit (door closed, NC)
Lock Monitor Circuit (unlocked, NO)
Lock Monitor Circuit (locked, NC)



The characteristics shown in the chart above are of the HS9Z-A61, -A62, -A65, and -A66 actuators. For the HS9Z-A62S actuator, subtract 0.6 mm. The characteristics show the contact status when the actuator enters an entry slot of an interlock switch.

Operating Instructions

Minimum Radius of Hinged Door

- When using the interlock switch on hinged doors, refer to the minimum radius of doors shown below. When using on doors with small minimum radius, use the angle adjustable actuator (HS9Z-A65 and HS9Z-A66).

Note: Because deviation or dislocation of hinged doors may occur in actual applications, make sure of the correct operation before installation.

When Using the HS9Z-A62/A62S Right-angle Actuator

- When door hinge is on the extension line of the interlock switch surface:

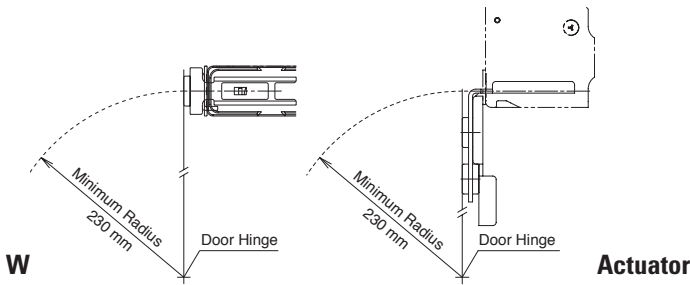
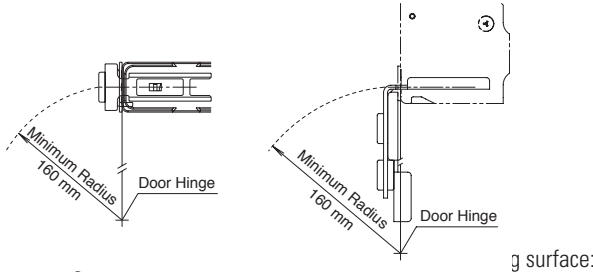

- When door hinge is on the extension line of the interlock switch surface

Horizontal Adjustment

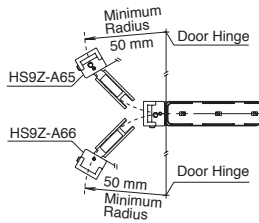

Vertical Adjustment

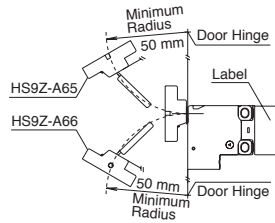

- When door hinge is on the extension line of the actuator mounting surface

Horizontal Adjustment

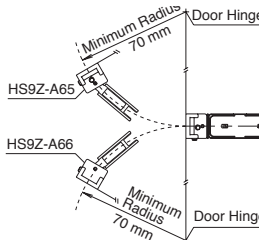

Vertical Adjustment

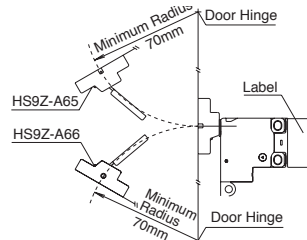

Actuator Angle Adjustment for the HS9Z-A65/HS9Z-A66

- Using the angle adjustment screw, the actuator angle can be adjusted (see figures on page 370).
Adjustable angle: 0 to 20°
- The larger the adjusted angle of the actuator, the smaller the applicable radius of the door opening.
- After installing the actuator, open the door. Then adjust the actuator so that its edge can enter properly into the actuator entry slot of the interlock switch.
- After adjusting the actuator angle, apply Loctite to the adjustment screw so that the screw will not become loose.

Mounting Examples

Application on Sliding Doors

Application on Hinged Doors

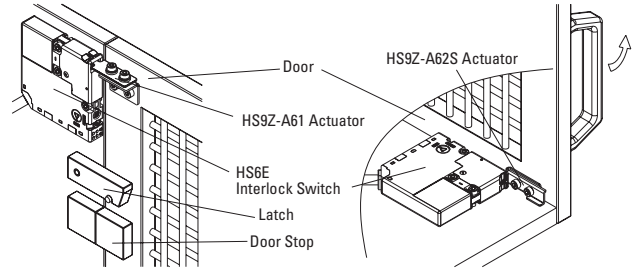

Note: When mounting the actuator, make sure that the actuator enters the slot in the correct direction, as shown on the right.

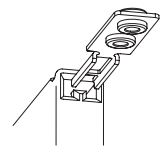

For Manual Unlocking

When using the manual unlock key

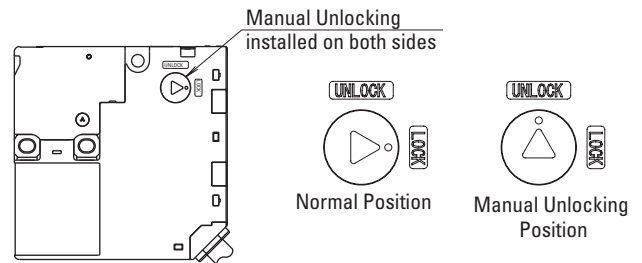

- Using the interlock switch with the actuator not fully turned (less than 90°) may cause damage to the interlock switch or operation failures (when manually unlocked, the switch will keep the main circuit disconnected and the door unlocked).
- Do not apply excessive force (0.45 N·m or more) to the manual unlock part, otherwise the manual unlock part will become damaged.

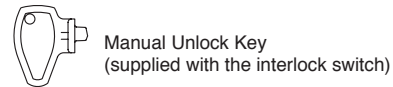

See instruction manual for full details.

Recommended Tightening Torque of Mounting Screws

- Interlock switch: 1.0 to 1.5 N·m (three M4 screws)
- Actuators: 1.0 to 1.5 N·m (two M4 screws)

Cables

- Do not fasten or loosen the gland at the bottom of the interlock switch.
- When bending the cable during wiring, make sure that the cable radius is kept at 30 mm minimum.
- When wiring, make sure that water or oil does not enter from the end of the cable.
- Do not open the lid of the interlock switch. Otherwise the interlock switch will be damaged.
- The solenoid has polarity. Make sure of the correct polarity when wiring.

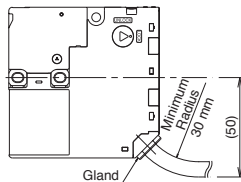
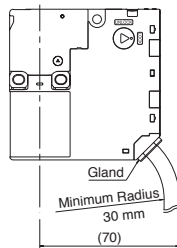

Wire Identification

- Wires can be identified by color and or a white line printed on the wire.

No.	Insulation Color	No.	Insulation Color
1	Blue/White	7	White
2	Gray	8	Black
3	Pink	9	Pink/White
4	Orange	10	Brown/White
5	Orange/White	11	Brown
6	Gray/White	12	Blue

Terminal Number Identification

- When wiring, identify the terminal number of each contact by the color of the insulation.
- The following table shows the identification of terminal numbers.
- When wiring, cut unused wires to avoid incorrect wiring.

Type	Contact Arrangement	
	Door Monitor	Lock Monitor
HS6E-L		
	Main circuit: Blue → 11	12
	Monitor circuit: Brown → 21	22 Brown/White Pink 53
HS6E-M	Main circuit: Blue → 11	12
	Monitor circuit: Brown → 21	22 Brown/White Pink 51
	Monitor circuit: Orange → 31	32 Orange/White
HS6E-N	Main circuit: Blue → 11	12
	Monitor circuit: Brown → 21	22 Brown/White Pink 53
	Monitor circuit: Orange → 33	34 Orange/White
HS6E-P	Main circuit: Blue → 11	12
	Monitor circuit: Brown → 21	22 Brown/White Pink 51
	Monitor circuit: Orange → 33	34 Orange/White

Note: The contact arrangements show the contact status when the actuator is inserted and locked.

X-ON Electronics

Largest Supplier of Electrical and Electronic Components

Click to view similar products for [Switch Fixings](#) category:

Click to view products by [Idec](#) manufacturer:

Other Similar products are found below :

[893102000](#) [00-5150](#) [LZZ1A](#) [0098.9234](#) [61-9451.0](#) [M2PA-5011](#) [630155](#) [635401](#) [6PA113](#) [6PA147-E6](#) [6PA148-E6](#) [6PA32](#) [6PA9](#) [700106](#)
[700109](#) [700303A56](#) [700C1GRY](#) [700C2GRN](#) [704-6001](#) [704.960.9](#) [704.965.2](#) [704.965.6](#) [704.966.0](#) [7089-3](#) [710082-B11](#) [71M1048](#)
[757200264](#) [764300000](#) [MHU35](#) [MHU37](#) [807039-1](#) [825.003.011](#) [825.005.011](#) [825.053.011](#) [825.055.011](#) [826.000.071](#) [827.020.011](#)
[827.400.021](#) [835.900.023](#) [MML52C10C](#) [MML52E10C](#) [MML92HGH](#) [MML93K](#) [84211M02CNNS](#) [84212M02CNNS](#) [84217A8.0LNOS](#)
[842.500.011](#) [843187-000](#) [843487-000](#) [84-901](#)