

## HW Series – 22mm IEC Style Global Pushbuttons

### Key features:

- Locking lever removable contact blocks
- Finger-safe IP20 contacts
- Tamperproof construction
- All E-stops meet EN60947-5-5, and are compliant with SEMI S2 standards
- Worldwide approvals
- Easy to assemble
- Choice of black plastic or metallic front bezels
- LED illumination
- Transformer or full voltage
- Slow make double break contacts



### HW: The Best Engineered Switch in the World

IDEC's HW switches are "The best engineered switch in the world" for a reason. Carrying the CE mark, UL, CSA, CCC (Chinese), and TUV approvals, these switches are designed for use in almost any part of the world.

include illuminated and non-illuminated pushbuttons, pilot lights, selector switches, and emergency stop switches.

Complete with finger-safe contact blocks offering IP20 protection, these 7/8" (22mm) switches

All switches also incorporate mechanically keyed safety locking levers, ensuring correct installation and maintaining safety in high-vibration applications.



File No. E68961



File No. LR21451



TUV Rheinland Certificate No. R50086203\_HW\_e-stop R50391189\_HW



Certificate No. 2017010305987846

### Specifications

Electrical	Rated Operational Characteristics	AC-15: A600 or Ue = 250V, Ie = 3A (NO, NC, NO-EM, NC-LB) DC-13: P600 or Ue = 125V, Ie = 1.1A (NO, NC) DC-13: Q600 or Ue = 125V, Ie = 0.9A (NO-EM, NC-LB)					
	Rated Insulation Voltage	600V					
	Rated Switching Over-Voltage	Less than 4kV, conforming to IEC60947-1					
	Rated Impulse Withstanding Voltage	4kV for contact circuit, 2.5kV for lamp circuit					
	Rated Thermal Current	10 Amp					
	Minimum Switching Capacity	5 mA at 3V AC/DC					
	Electrical Reliability	MTBF < 1 fault for 10 million operation cycles (3V DC, 5mA)					
	Lamp Ratings	LEDs: 6V/17mA max, 12V & 24V/11mA max, 120 & 240V/10mA max					
Mechanical	Contact Operation	Slow break NC or NO					
	Positive Action Operation (Emergency Stops with NC contacts)	5.5mm to 10mm travel to latch, 45N minimum force to latch 10mm maximum travel, 1,800 operations per hour maximum for a Pushlock Turn Reset 900 operations per hour maximum for a Push-Pull					
	Operating Force	Flush and extended pushbuttons—with 1NO or 1NC contact: 6.2±2N (momentary), 7.0±2N (maintained) Additional contacts—1NO or 1NC: +3.2N (momentary), + 3.3N (maintained)					
	Recommended Terminal Torque	Unit	Wire	Number of Wires	Recommended Tightening Torque (Nm)	Terminal Screw	
							Crimping Terminal
		HW-U Contact Block	Solid Wire	ø0.5 to 1.6 mm (AWG14 to 22)	2	1.0 to 1.3	
			Stranded Wire	0.3 to 2.0 mm <sup>2</sup> (AWG14 to 22) 2.1 to 3.5 mm <sup>2</sup> (AWG12)	1 2 1	1.2 to 1.3 1.0 to 1.3 1.2 to 1.3	
	Illuminated Unit (*1)	Crimping Terminal	Solid Wire	ø0.5 to 1.6 mm (AWG14 to 22)	2	1.0 to 1.3	M3.5
			Stranded Wire	0.3 to 2.0 mm (AWG14 to 22)			
	Applicable Wire Size	Pilot Light	Crimping Terminal	Number of Wires	Recommended Tightening Torque (Nm)		
Solid Wire					ø0.5 to 1.6 mm (AWG14 to 22)	2	0.6 to 1.0 (M3.0)
		Stranded Wire	ø0.3 to 2.0 mm (AWG14 to 22)		1.0 to 1.3 (M3.5)		
	1. * refers to the lamp terminals of the illuminated push buttons and selector switches.						
Applicable Wire Size	Minimum 1 x 22 AWG, max. 2 x 14 AWG or 1 x 12 AWG						
Contact Resistance	Initial contact resistance of 50mΩ or less						
Contact Gap	4mm (NO and NC), 2mm (NO-EM and NC-LB)						
Horsepower Rating	Reference Value: 1/4 HP @ 120V (1ø non-reversing), 1HP @ 240V (3ø non-reversing)						
Contact Material	Silver (gold plated contacts available - contact IDEC)						
Operating Temperature	Operation: -25 to +60°C (illuminated -25 to +50°C dome -25 to +55°C)						
Vibration Resistance	10 to 55Hz, 98m/sec <sup>2</sup> (10G) conforming to IEC6068-2-6						
Shock Resistance	980m/sec <sup>2</sup> (100G) conforming to IEC6068-2-7						
Mechanical Life	Momentary pushbuttons: 5,000,000 (900 operations per hour), All other switches: 500,000						

Switches & Pilot Devices

Signaling Lights

Relays & Sockets

Timers

Contactors



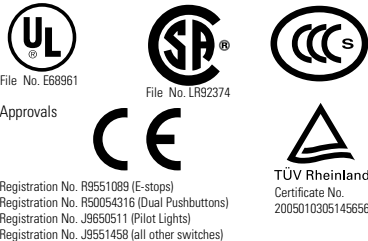

Terminal Blocks

Circuit Breakers

Conforming to Standards		EN60947-1, EN60947-5-1, VDE0660-200, UL508, CSA C22-2 No.14							
Standards & Approvals	 <p>File No. E68961 File No. LR92374</p> <p>Approvals</p> <p>Registration No. R9551089 (E-stops) Registration No. R50054316 (Dual Pushbuttons) Registration No. J9650511 (Pilot Lights) Registration No. J9551458 (all other switches)</p>		<p>CSA: pushbuttons and selector switches: A600 pilot lights and illuminated pushbuttons, direct supply pilot lights and illuminated pushbuttons with integral transformer (100/110, 115, 120, 200/220, 230, 240, 380, 400/440, 480V)</p> <p>UL: pushbuttons and selector switches: A600 pilot lights and illuminated pushbuttons, direct supply pilot lights and illuminated pushbuttons with integral transformer (100/110, 115, 120, 200/220, 230, 240, 380, 400/440, 480V)</p> <p>TÜV: pushbuttons and selector switches: A600-P600 (NO, NC)/O600 (NO-EM, NC-LB) pilot lights and illuminated pushbuttons, direct supply pilot lights and illuminated pushbuttons with integral transformer (100/110, 115, 120, 200/220, 230, 240, 380, 400/440, 480V)</p>						
	Electric Shock Protection		Class 2 conforming to IEC60664-7						
	Degree of Protection (conforming to IEC60529 and UL50)		UL Type 1, 4X, 12, 13 <sup>1</sup> IP65 (from front of the panel) IP20 (Type HW-U contact block)						
	Pollution Degree (conforming to IEC60947-1)		3						
	External Short-Circuit Protection		10A 250V fuse conforming to IEC60269-1						
Contact Ratings	Pushbuttons Illuminated Pushbuttons Selector Switches Illuminated Selector Switches Pushbutton Selector		Contact Block			Type HW-U			
			Rated Insulation Voltage			600V			
			Rated Continuous Current			10A			
			Contact Ratings by Utilization Category IEC 60947-5-1			AC-15 (A600) DC-13 (P600)			
Characteristics	Operational Voltage		24V	48V	50V	110V	220V	440V	
	Operational Current	AC 50/60 Hz	AC-12 Control of resistive loads & solid state loads	10A	—	10A	10A	6A	2A
			AC-15 Control of electromagnetic loads (> 72VA)	10A	—	7A	5A	3A	1A
		DC	DC-12 Control of resistive loads & solid state loads	10A	5A	—	2.2A	1.1A	—
			DC-13 Control of electromagnets	5A	2A	—	1.1A	0.6A	—

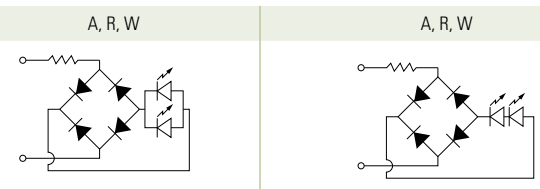
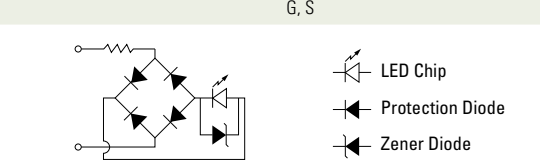
 For dimensions, see page 685.  
Note 1. Except HW2B

### LED Lamp Ratings (LSTD Type)

Model		LSTD-6Ⓢ	LSTD-1Ⓢ	LSTD-2Ⓢ	LSTD-H2Ⓢ	LSTD-M4Ⓢ
Lamp Base		BA9S/13				
Rated Voltage		6V AC/DC	12V AC/DC	24V AC/DC	120V AC	240V AC
Voltage Range		6V AC/DC ±10%	12V AC/DC ±10%	24V AC/DC ±10%	120V AC ±5%	240V AC ±5%
Current Draw	AC	A, R, W: G, S:	17mA 8mA	11mA	11mA	10mA
	DC	A, R, W: G, S:	14mA 5.5mA	10mA	10mA	—
Color Code		A (amber), G (green), R (red), S (blue), W (white)				
Lamp Base Color		Same as illumination color				
Voltage Marking		Die stamped on the base				
Life (reference value)		Approx. 50,000 hours (The luminance reduces to 50% the initial intensity when used on complete DC.)				
Internal Circuit	A, R, W					
	G, S					
			<ul style="list-style-type: none"> <li> LED Chip</li> <li> Protection Diode</li> <li> Zener Diode</li> </ul>			

 In place of Ⓢ, specify the Lens/LED Color Code.

**Non-Illuminated Round Pushbuttons (Assembled)**



Function	Contacts	Round Flush		Round Extended	
		Plastic Bezel	Metal Bezel	Plastic Bezel	Metal Bezel
Momentary	Operator Only	HW1B-M1-①	HW4B-M1-①	HW1B-M2-①	HW4B-M2-①
	1NO	HW1B-M1F10-①	HW4B-M1F10-①	HW1B-M2F10-①	HW4B-M2F10-①
	1NC	HW1B-M1F01-①	HW4B-M1F01-①	HW1B-M2F01-①	HW4B-M2F01-①
	1NO-1NC	HW1B-M1F11-①	HW4B-M1F11-①	HW1B-M2F11-①	HW4B-M2F11-①
	2NO	HW1B-M1F20-①	HW4B-M1F20-①	HW1B-M2F20-①	HW4B-M2F20-①
	2NC	HW1B-M1F02-①	HW4B-M1F02-①	HW1B-M2F02-①	HW4B-M2F02-①
	2NO-2NC	HW1B-M1F22-①	HW4B-M1F22-①	HW1B-M2F22-①	HW4B-M2F22-①
Maintained	Operator Only	HW1B-A1-①	HW4B-A1-①	HW1B-A2-①	HW4B-A2-①
	1NO	HW1B-A1F10-①	HW4B-A1F10-①	HW1B-A2F10-①	HW4B-A2F10-①
	1NC	HW1B-A1F01-①	HW4B-A1F01-①	HW1B-A2F01-①	HW4B-A2F01-①
	1NO-1NC	HW1B-A1F11-①	HW4B-A1F11-①	HW1B-A2F11-①	HW4B-A2F11-①
	2NO	HW1B-A1F20-①	HW4B-A1F20-①	HW1B-A2F20-①	HW4B-A2F20-①
	2NC	HW1B-A1F02-①	HW4B-A1F02-①	HW1B-A2F02-①	HW4B-A2F02-①
	2NO-2NC	HW1B-A1F22-①	HW4B-A1F22-①	HW1B-A2F22-①	HW4B-A2F22-①

**① Button Color Code**

Color	Code
Black	B
Green	G
Red	R
Blue	S
White	W
Yellow	Y



1. In place of ①, specify the Button Color Code from table below.
2. For nameplates and accessories, see page 680 and 683.
3. For dimensions, see page 685.
4. For contact assembly part numbers, see page 685.
5. All assembled part numbers in catalog include standard, Finger-Safe (HW-U...) contacts.
6. Operator only models include operator plus button.
7. Additional contact configurations available (up to 6 total contacts).

Part Number Structure

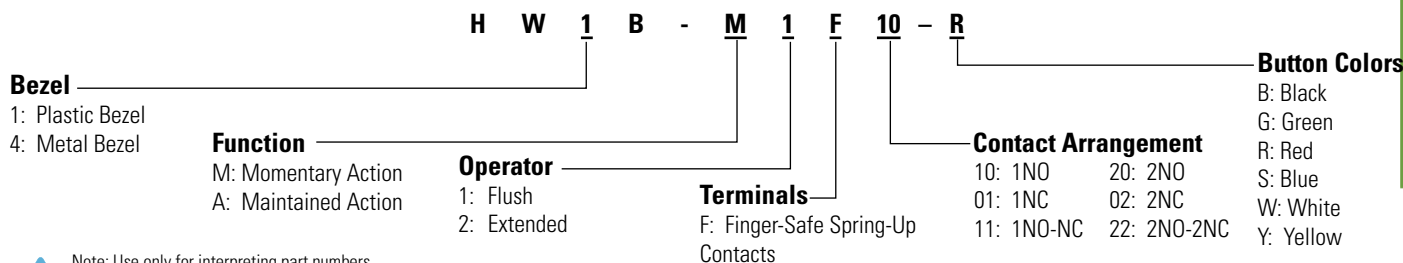

Note: Use only for interpreting part numbers. Do not use for developing part numbers.

Non-Illuminated Round Pushbuttons (Replacement Parts)

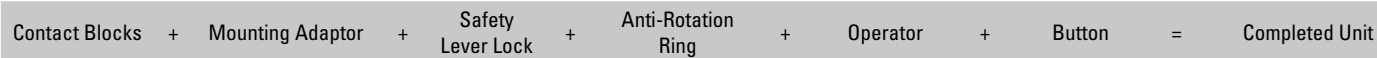

Contact Blocks

Style	Contacts	1NO	1NC
	Finger-Safe Spring-Up Terminal	HW-U10-F	HW-U01-F
		HW-U10R-F (early make)	HW-U01R-F (late break)
	Dummy Block	HW-DB	

Anti-Rotation Ring

Style	Part Number
	HW9Z-RL

Use with notched panel cutout to prevent unit rotation.

Buttons

Style	Part Number
Round Flush 	HW1A-B1-①
Round Extended 	HW1A-B2-①

1. In place of ①, specify the Button Color Code from table.

Contact Block Mounting Adaptor

Style	Part Number
	HW-CB2C

1. Used to mount contact blocks to operator.  
2. IDEC strongly recommends using the safety lever lock to prevent heavy vibration or maintenance personnel from inadvertently unlocking contacts.

Operators

Style		Plastic Bezel	Metal Bezel
Round Flush/ Extended 	Momentary	HW1B-M0	HW4B-M0
	Maintained 	HW1B-A0	HW4B-A0

Safety Lever Lock

Style	Part Number
	HW9Z-LS

① Button Color Code

Color	Code
Black	B
Green	G
Red	R
Blue	S
White	W
Yellow	Y

Non-Illuminated Mushroom Head Pushbuttons (Assembled)



		ø29mm Mushroom Head		ø40mm Mushroom Head	
Function	Contacts	Plastic Bezel	Metal Bezel	Plastic Bezel	Metal Bezel
Momentary	Operator Only	HW1B-M3-⓪	HW4B-M3-⓪	HW1B-M4-⓪	HW4B-M4-⓪
	1NO	HW1B-M3F10-⓪	HW4B-M3F10-⓪	HW1B-M4F10-⓪	HW4B-M4F10-⓪
	1NC	HW1B-M3F01-⓪	HW4B-M3F01-⓪	HW1B-M4F01-⓪	HW4B-M4F01-⓪
	1NO-1NC	HW1B-M3F11-⓪	HW4B-M3F11-⓪	HW1B-M4F11-⓪	HW4B-M4F11-⓪
	2NO	HW1B-M3F20-⓪	HW4B-M3F20-⓪	HW1B-M4F20-⓪	HW4B-M4F20-⓪
	2NC	HW1B-M3F02-⓪	HW4B-M3F02-⓪	HW1B-M4F02-⓪	HW4B-M4F02-⓪
	2NO-2NC	HW1B-M3F22-⓪	HW4B-M3F22-⓪	HW1B-M4F22-⓪	HW4B-M4F22-⓪
Maintained	Operator Only	HW1B-A3-⓪	HW4B-A3-⓪	HW1B-A4-⓪	HW4B-A4-⓪
	1NO	HW1B-A3F10-⓪	HW4B-A3F10-⓪	HW1B-A4F10-⓪	HW4B-A4F10-⓪
	1NC	HW1B-A3F01-⓪	HW4B-A3F01-⓪	HW1B-A4F01-⓪	HW4B-A4F01-⓪
	1NO-1NC	HW1B-A3F11-⓪	HW4B-A3F11-⓪	HW1B-A4F11-⓪	HW4B-A4F11-⓪
	2NO	HW1B-A3F20-⓪	HW4B-A3F20-⓪	HW1B-A4F20-⓪	HW4B-A4F20-⓪
	2NC	HW1B-A3F02-⓪	HW4B-A3F02-⓪	HW1B-A4F02-⓪	HW4B-A4F02-⓪
	2NO-2NC	HW1B-A3F22-⓪	HW4B-A3F22-⓪	HW1B-A4F22-⓪	HW4B-A4F22-⓪



		ø60mm Mushroom Head
Function	Contacts	Plastic Bezel
Momentary	Operator Only	HW1B-M5-⓪*
	1NO	HW1B-M5F10-⓪*
	1NC	HW1B-M5F01-⓪*
	1NO-1NC	HW1B-M5F11-⓪*
	2NO	HW1B-M5F20-⓪*
	2NC	HW1B-M5F02-⓪*
	2NO-2NC	HW1B-M5F22-⓪*

⓪ Button Color Code

Color	Code
Black	B
Green	G
Red	R
Blue	S
White	W
Yellow	Y



1. In place of ⓪, specify the Button Color Code from table.
2. \*60mm mushroom available only in red, green, black, and yellow.
3. For nameplates and accessories, see page 680 and 683.
4. For dimensions, see page 685.
5. For contact assembly part numbers, see page 685.
6. All assembled part numbers in catalog include standard spring-up Finger-Safe (HW-U...) contacts.
7. Operator only models include operator plus button.
8. Additional contact configurations available (up to 6 total contacts).

Switches & Pilot Devices

Signaling Lights

Relays & Sockets

Timers

Contactors

Terminal Blocks

Circuit Breakers

Part Number Structure

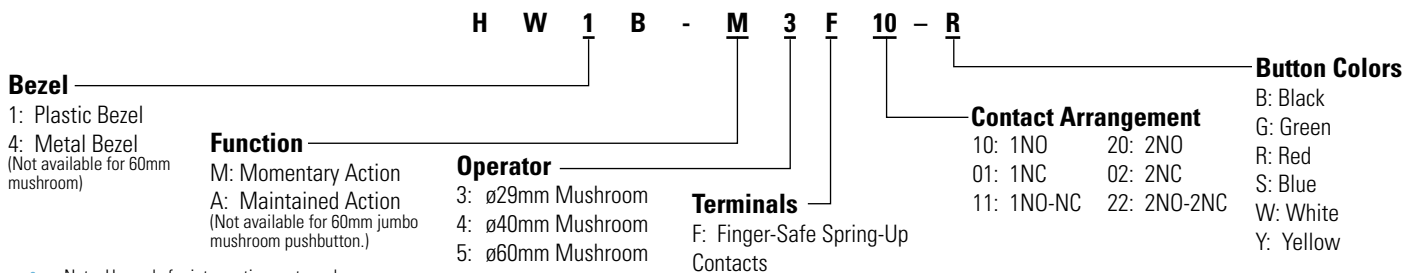

Non-Illuminated Mushroom Head Pushbuttons (Replacement Parts)

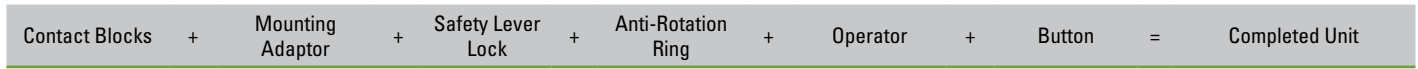

Contact Blocks

Style	Contacts	1NO	1NC
	Finger-Safe Spring-Up Terminal	HW-U10-F	HW-U01-F
		HW-U10R-F (early make)	HW-U01R-F (late break)
	Dummy Block	HW-DB	

Contact Block Mounting Adaptor

Style	Part Number
	HW-CB2C

- Used to mount contact blocks to operator.
- IDEC strongly recommends using the safety lever lock to prevent heavy vibration or maintenance personnel from inadvertently unlocking contacts.

Safety Lever Lock

Style	Part Number
	HW9Z-LS

Anti-Rotation Ring

Appearance	Part Number
	HW9Z-RL

Operators

Style	Plastic Bezel	Metal Bezel
ø29mm Mushroom ø40mm Mushroom	Momentary	HW1B-MOL
	Maintained	HW1B-AOL
ø60mm Jumbo Mushroom	Momentary	HW1B-M5-⊙*
	Maintained	-

- \*60mm mushroom operator includes non-removable button (available in red, black, green and yellow).
- For nameplates and accessories, see page 680 and 683.
- For dimensions, see page 685.

Buttons

Style	Part Number
ø29mm Mushroom Cap	HW1A-B3-⊙
ø40mm Mushroom Cap	HW1A-B4-⊙

- In place of ⊙, specify the Button Color Code from table.

⊙ Button Color Code

Color	Code	Color	Code
Black	B	Blue	S
Green	G	White	W
Red	R	Yellow	Y

- HW1B-M5 available only in black, red, green and yellow.

**Non-Illuminated Square Pushbuttons (Assembled)**



Function	Contacts	Square Flush	Square Extended
		Plastic Bezel	Plastic Bezel
Momentary	<i>Operator Only</i>	HW2B-M1-①	HW2B-M2-①
	1NO	HW2B-M1F10-①	HW2B-M2F10-①
	1NC	HW2B-M1F01-①	HW2B-M2F01-①
	1NO-1NC	HW2B-M1F11-①	HW2B-M2F11-①
	2NO	HW2B-M1F20-①	HW2B-M2F20-①
	2NC	HW2B-M1F02-①	HW2B-M2F02-①
	2NO-2NC	HW2B-M1F22-①	HW2B-M2F22-①
Maintained	<i>Operator Only</i>	HW2B-A1-①	HW2B-A2-①
	1NO	HW2B-A1F10-①	HW2B-A2F10-①
	1NC	HW2B-A1F01-①	HW2B-A2F01-①
	1NO-1NC	HW2B-A1F11-①	HW2B-A2F11-①
	2NO	HW2B-A1F20-①	HW2B-A2F20-①
	2NC	HW2B-A1F02-①	HW2B-A2F02-①
	2NO-2NC	HW2B-A1F22-①	HW2B-A2F22-①

① **Button Color Code**

Color	Code
Black	B
Green	G
Red	R
Blue	S
White	W
Yellow	Y



1. In place of ①, specify the Button Color Code from table.
2. For nameplates and accessories, see page 680 and 683.
3. For dimensions, see page 685.
4. For contact assembly part numbers, see page 685.
5. Square pushbuttons available in plastic bezel only.
6. All assembled part numbers in catalog include finger-safe spring-up (HW-U...) contacts.
7. Operator only model includes operator and button.
8. Additional contact configurations available (up to 6 total contacts).

Part Number Structure

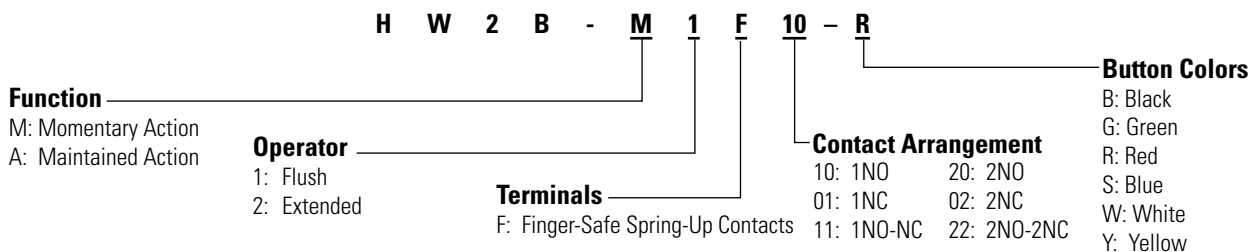

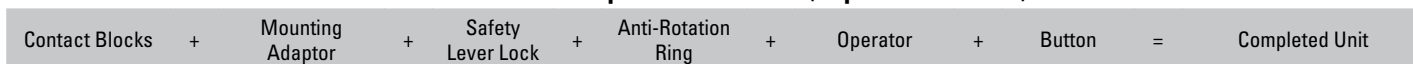

 Note: Use only for interpreting part numbers. Do not use for developing part numbers.

Non-Illuminated Square Pushbuttons (Replacement Parts)



Contact Blocks

Style	Contacts	1NO	1NC
	Finger-Safe Spring-Up Terminal	HW-U10-F	HW-U01-F
		HW-U10R-F (early make)	HW-U01R-F (late break)
	Dummy Block	HW-DB	

Contact Block Mounting Adaptor

Style	Part Number
	HW-CB2C

-  1. Used to mount contact blocks to operator.  
2. IDEC strongly recommends using the safety lever lock to prevent heavy vibration or maintenance personnel from inadvertently unlocking contacts.

Safety Lever Lock

Style	Part Number
	HW9Z-LS

Anti-Rotation Ring

Appearance	Part Number
	HW9Z-RL

-  Use with notched panel cutout to prevent unit rotation.

Operators

Style	Plastic Bezel
	Momentary HW2B-M0
	Maintained HW2B-A0

-  2. For nameplates and accessories, see pages 680 and 683.  
3. For dimensions, see page 685.

Buttons

Style	Part Number
Square Flush 	HW2A-B1-⓪
Square Extended 	HW2A-B2-⓪

-  1. In place of ⓪, specify the Button Color Code from table.

⓪ Button Color Code

Color	Code	Color	Code
Black	B	Blue	S
Green	G	White	W
Red	R	Yellow	Y



**Non-Illuminated E-Stop Pushbuttons (Assembled)**



Contacts	Ø29mm Head Pushlock Turn Reset		Ø40mm Head Pushlock Turn Reset	
	Plastic Bezel	Metal Bezel	Plastic Bezel	Metal Bezel
<i>Operator Only</i>	HW1B-V3Ⓞ†	HW4B-V3Ⓞ†	HW1B-V4Ⓞ†	HW4B-V4Ⓞ†
1NO	HW1B-V3F10-Ⓞ†	HW4B-V3F10-Ⓞ†	HW1B-V4F10-Ⓞ†	HW4B-V4F10-Ⓞ†
1NC	HW1B-V3F01-Ⓞ†	HW4B-V3F01-Ⓞ†	HW1B-V4F01-Ⓞ†	HW4B-V4F01-Ⓞ†
1NO-1NC	HW1B-V3F11-Ⓞ†	HW4B-V3F11-Ⓞ†	HW1B-V4F11-Ⓞ†	HW4B-V4F11-Ⓞ†
2NO	HW1B-V3F20-Ⓞ†	HW4B-V3F20-Ⓞ†	HW1B-V4F20-Ⓞ†	HW4B-V4F20-Ⓞ†
2NC	HW1B-V3F02-Ⓞ†	HW4B-V3F02-Ⓞ†	HW1B-V4F02-Ⓞ†	HW4B-V4F02-Ⓞ†



Contacts	Ø40mm Head EMO Pushlock Turn Reset		Ø40mm Head Pushlock Key Reset	
	Plastic Bezel	Metal Bezel	Plastic Bezel	Metal Bezel
<i>Operator Only</i>	HW1B-V4R-EMO-2*	HW4B-V4R-EMO-2*	HW1B-X4R*	HW4B-X4R*
1NO	HW1B-V4F10-R-EMO-2*	HW4B-V4F10-R-EMO-2*	HW1B-X4F10-R*	HW4B-X4F10-R*
1NC	HW1B-V4F01-R-EMO-2*	HW4B-V4F01-R-EMO-2*	HW1B-X4F01-R*	HW4B-X4F01-R*
1NO-1NC	HW1B-V4F11-R-EMO-2*	HW4B-V4F11-R-EMO-2*	HW1B-X4F11-R*	HW4B-X4F11-R*
2NO	HW1B-V4F20-R-EMO-2*	HW4B-V4F20-R-EMO-2*	HW1B-X4F20-R*	HW4B-X4F20-R*
2NC	HW1B-V4F02-R-EMO-2*	HW4B-V4F02-R-EMO-2*	HW1B-X4F02-R*	HW4B-X4F02-R*



- \* Available in Red only.
- † Available in red or yellow. Insert color code in place of Ⓞ (R: Red, Y: Yellow).
- For accessories, see page 683.
- For dimensions, see page 685.
- For nameplates and shrouds, see page 685.
- For contact assembly part numbers, see page 685.
- All HW series E-stops comply with EN60947-5-5, the IEC "E-Stop Addendum to the Low Voltage Directive," this includes "tamper proof" operation whereby a change of contact state is not possible by "teasing" or "floating" the operator.
- All assembled part numbers in catalog include standard finger-safe spring-up (HW-U...) contacts.
- Operator only models include operator and button.
- Additional contact configurations available (up to 6 total contacts).

Contacts	ø60mm Head Pushlock Turn Reset
	Plastic Bezel
<i>Operator Only</i>	HW1B-V5R*
1NO	HW1B-V5F10-R*
1NC	HW1B-V5F01-R*
1NO-1NC	HW1B-V5F11-R*
2NO	HW1B-V5F20-R*
2NC	HW1B-V5F02-R*

Part Number Structure

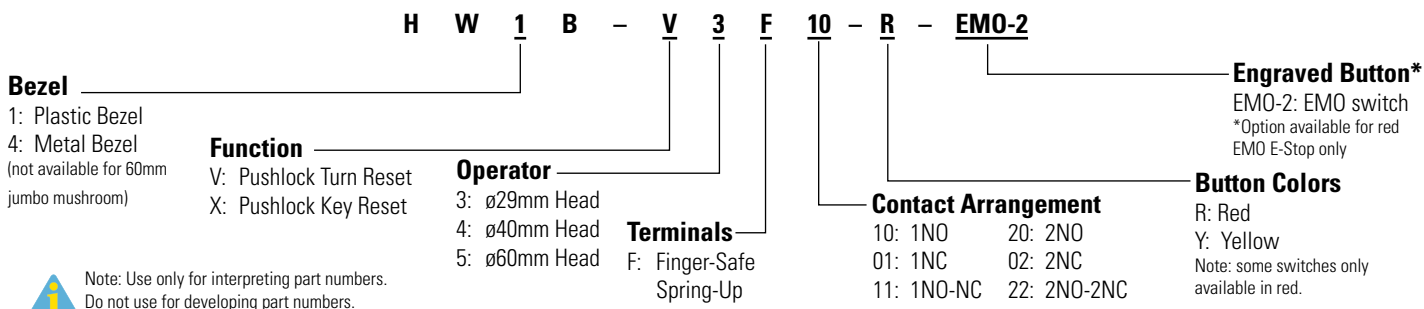

Non-Illuminated E-Stop Pushbuttons (Replacement Parts)

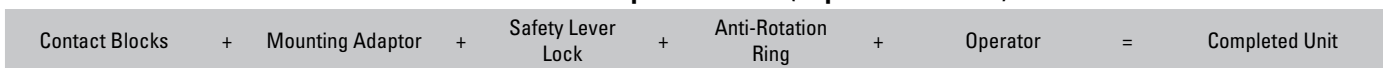

Contact Blocks

Style	Contacts	1NO	1NC
	Finger-Safe Spring-Up Terminal	HW-U10-F	HW-U01-F
		HW-U10R-F (early make)	HW-U01R-F (late break)
	Dummy Block	HW-DB	

Safety Lever Lock

Style	Part Number
	HW9Z-LS

Anti-Rotation Ring

Appearance	Part Number
	HW9Z-RL

Use with notched panel cutout to prevent unit rotation.

Contact Block Mounting Adaptor

Style	Part Number
	HW-CB2C

- Used to mount contact blocks to operator.
- IEDEC strongly recommends using the safety lever lock to prevent heavy vibration or maintenance personnel from inadvertently unlocking contacts.

Operators

Style	Plastic	Metal
ø29mm Head Pushlock Turn Reset 	red	HW1B-V3R HW4B-V3R
	yellow	HW1B-V3Y HW4B-V3Y
ø40mm Head Pushlock Turn Reset 	red	HW1B-V4R HW4B-V4R
	yellow	HW1B-V4Y HW4B-V4Y
ø40mm Head EMO Pushlock Turn Reset* 		HW1B-V4R-EMO-2 HW4B-V4R-EMO-2
ø40mm Head Pushlock Key Reset* 		HW1B-X4R HW4B-X4R
ø60mm Head Pushlock Turn Reset* 		HW1B-V5R -

- \* Available in red only.
- All E-Stop buttons are not removable from the operator.

Note: Determine mounting centers to ensure proper spacing.

Push Pull & Unibody E-Stop Pushbuttons (Assembled)



Contacts	ø40mm Head Push-Pull	
	Plastic Bezel	Metal Bezel
Operator Only (Red)	HW1B-Y2R	HW4B-Y2R
Operator Only (Yellow)	HW1B-Y2Y	HW4B-Y2Y
1NO	HW1B-Y2F10-ⓐ†	HW4B-Y2F10-ⓐ†
1NC	HW1B-Y2F01-ⓐ†	HW4B-Y2F01-ⓐ†
1NO-1NC	HW1B-Y2F11-ⓐ†	HW4B-Y2F11-ⓐ†
2NC	HW1B-Y2F02-ⓐ†	HW4B-Y2F02-ⓐ†
2NO	HW1B-Y2F20-ⓐ†	HW4B-Y2F20-ⓐ†

Contacts	ø40mm Unibody Pushlock Turn Reset*
	Plastic Bezel
1NO-1NC	HW1E-BV4F11-R
2NC	HW1E-BV4F02-R
1NO-2NC*	HW1E-BV412R-TK2093-1



\* NO contact is used as a monitoring contact



Contacts	Unibody Illuminated E-Stops*
	LED
1NO-1NC	HW1E-LV4F11QD-R-ⓐ
2NC	HW1E-LV4F02QD-R-ⓐ
2NC (with push-on illumination)	HW1E-TV4F02QD-R-ⓐ
1NO-1NC (with push-on illumination)	HW1E-TV4F11QD-R-ⓐ

ⓐ Full Voltage LED Code

Voltage	Code
6VAC/DC	6V
12VAC/DC	12V
24VAC/DC	24V
120V AC	120V
240V AC	240V

Terminal Numbering (Unibody only)

Models	Terminal Number
1NO-1NC	NO = 13/14, NC = 11/12
2NC	NC = 11/12, NC = 21/22
HW1E-L HW1E-T	LED + = X2, LED - = X1



- \* Available in Red only.
- † Available in red or yellow. Insert color code in place of ⓐ (R: Red, Y: Yellow).
- In place of ⓐ, specify Full Voltage LED Code.
- With single unit construction, the positive action contacts are integrated in the body of the switch. This provides an extra degree of safety and reliability for critical emergency stop functions.
- In the illuminated version, the light is independent of the switch action (except push-on LED model).
- For accessories, see page 683.
- For dimensions, see page 685.
- For nameplates and shrouds, see page 683.
- For contact assembly part numbers, see page 683.
- All HW Series E-Stop operators include non-removable color caps.
- All HW series E-Stops comply with EN60947-5-5, the IEC "E-Stop Addendum to the Low Voltage Directive," this includes "tamper proof" operation whereby a change of contact state is not possible by "teasing" or "floating" the operator.
- All HW series E-Stop switches comply with SEMI S2 standards.
- All assembled part numbers in catalog include standard finger-safe spring-up (HW-U...) contacts.
- Additional contact configurations available (up to 6 total contacts).

Part Number Structure

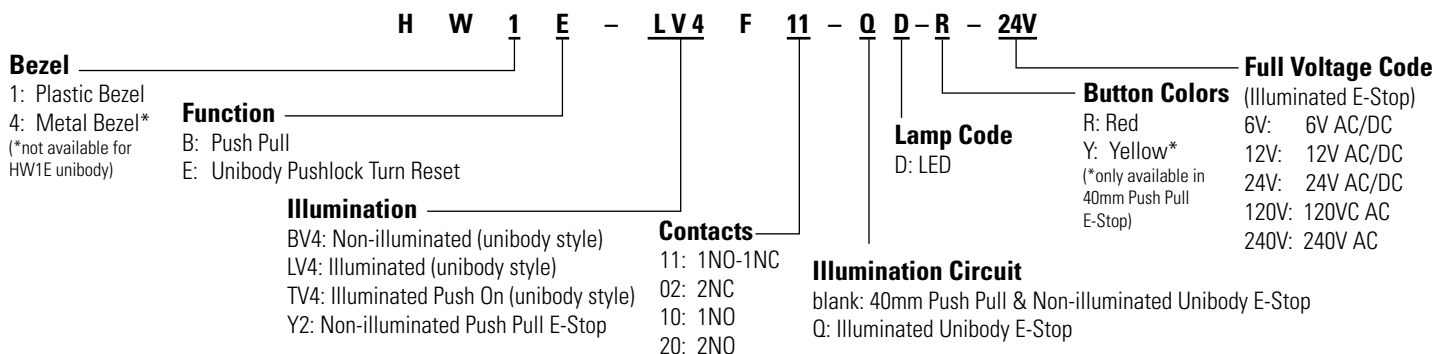

Note: Use only for interpreting part numbers. Do not use for developing part numbers.

Illuminated & Non-Illuminated E-Stop Pushbuttons (Replacement Parts)

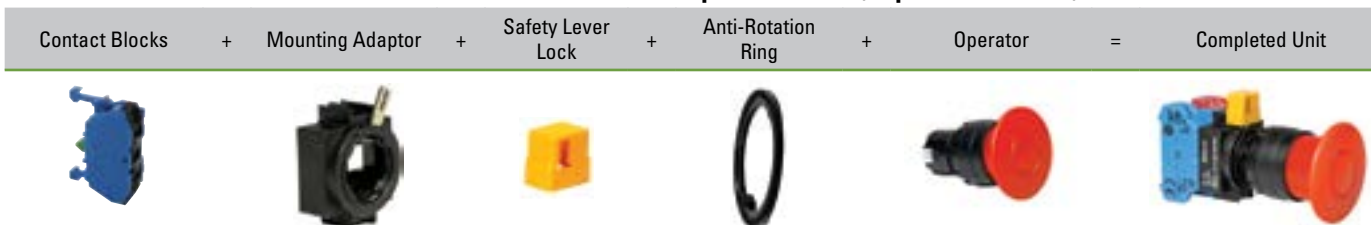

Contact Blocks

Style	Contacts	1NO	1NC
	Finger-Safe Spring-Up Terminal	HW-U10-F	HW-U01-F
		HW-U10R-F (early make)	HW-U01R-F (late break)
	Dummy Block	HW-DB	

- There are no replacement parts for the HW1E unibody E-Stop.
- For illuminated unibody E-Stop, see page 685 for replacement lens.

Contact Block Mounting Adaptor

Style	Part Number
	HW-CB2C

- Used to mount contact blocks to operator.
- IEDEC strongly recommends using the safety lever lock to prevent heavy vibration or maintenance personnel from inadvertently unlocking contacts.

Safety Lever Lock

Style	Part Number
	HW9Z-LS

Anti-Rotation Ring

Appearance	Part Number
	HW9Z-RL

Use with notched panel cutout to prevent unit rotation.

Operators

Style		Part Number
ø40mm Head Push-Pull	Plastic	HW1B-Y2R
	Metal	HW4B-Y2R
	Plastic	HW1B-Y2Y
	Metal	HW4B-Y2Y

All E-Stop Buttons are not removable from the operator.

**E-Stop Stations**



	29mm Pushlock Turn Reset		40mm Pushlock Turn Reset	
Contacts	Plastic Bezel	Metal Bezel	Plastic Bezel	Metal Bezel
1NO-1NC	FB1W-HW1B-V311R	FB1W-HW4B-V311R	FB1W-HW1B-V411R	FB1W-HW4B-V411R
2NC	FB1W-HW1B-V302R	FB1W-HW4B-V302R	FB1W-HW1B-V402R	FB1W-HW4B-V402R



	40mm Push-Pull Reset		40mm Pushlock Key Reset	
Contacts	Plastic Bezel	Metal Bezel	Plastic Bezel	Metal Bezel
1NO-1NC	FB1W-HW1B-Y211R	FB1W-HW4B-Y211R	FB1W-HW1B-X411R	FB1W-HW4B-X411R
2NC	FB1W-HW1B-Y202R	FB1W-HW4B-Y202R	FB1W-HW1B-X402R	FB1W-HW4B-X402R



	40mm EMO Pushlock Turn Reset	
Contacts	Plastic Bezel	Metal Bezel
1NO-1NC	FB1W-HW1B-V411R-EMO-2	FB1W-HW4B-V411R-EMO-2
2NC	FB1W-HW1B-V402R-EMO-2	FB1W-HW4B-V402R-EMO-2

- 1. Maximum of two contact blocks.
- 2. Box is supplied with yellow top and black bottom only.

### Jumbo Dome Pilot Lights



Plastic Bezel

Actual Size



Jumbo Dome	LED	Operator Only	HW1P-500
		Full Voltage 24V AC/DC	HW1P-504-Ⓢ

- 1. In place of Ⓢ, specify the Lens/LED Color Code.
- 2. Spring-Up terminals with 24V LED.
- 3. For nameplates and accessories, see page 680 and 683.
- 4. For dimensions, see page 685.

#### Ⓢ Lens/LED Color Code

Color	Code
Amber	A
Green	G
Red	R
Blue	S
White	W
Yellow	Y



#### Jumbo Dome Replacement Parts

Item	Appearance	Description	Part Number
Lens		Polycarbonate Lens	HW1A-P5Ⓢ
LED Diffusing Lens			HW9Z-PP5C
LED Lamps		LED Lamp	LSTDB-2Ⓢ

- 1. In place of Ⓢ, specify the Lens/LED Color Code.
- 2. Use white LED for yellow lens.

#### Lamp Ratings

	Part Number	Operating Voltage	Rated Current	Power Consumption
LED	LSTDB-2	24V AC/DC ±10%	15mA	0.36W



Pilot Lights (Assembled)



		Round Flush		Dome	
		Plastic Bezel	Metal Bezel	Plastic Bezel	Metal Bezel
Operator Only		HW1P-1FQ0-②	HW4P-1FQ0-②	HW1P-2FQ0-②	HW4P-2FQ0-②
Full Voltage		HW1P-1FQD-②-③	HW4P-1FQD-②-③	HW1P-2FQD-②-③	HW4P-2FQD-②-③
Transformer	120V AC	HW1P-1FH2D-②	HW4P-1FH2D-②	HW1P-2FH2D-②	HW4P-2FH2D-②
	240V AC	HW1P-1FM4D-②	HW4P-1FM4D-②	HW1P-2FM4D-②	HW4P-2FM4D-②
	480V AC	HW1P-1FT8D-②	HW4P-1FT8D-②	HW1P-2FT8D-②	HW4P-2FT8D-②
DC-DC Converter*	110V DC	HW1P-1D2D-②	—	HW1P-2D2D-②	—



		Square Flush
		Plastic Bezel
Operator Only		HW2P-1FQ0-②
Full Voltage		HW2P-1FQD-②-③
Transformer	120V AC	HW2P-1FH2D-②
	240V AC	HW2P-1FM4D-②
	480V AC	HW2P-1FT8D-②
DC-DC Converter*	110V DC	HW2P-1D2D-②

 \* DC-DC converter voltage input from 90-140V DC.

② Lens/LED Color Code

Color	Code
Amber	A
Green	G
Red	R
Blue	S
White	W
Yellow	Y

③ LED Full Voltage Code

Voltage	Code
6VAC/DC	6V
12VAC/DC	12V
24VAC/DC	24V
120V AC	120V
240V AC	240V



1. In place of ②, specify the Lens/LED Color Code from table below.
2. In place of ③ specify the Full Voltage Code from table below.
3. For nameplates and accessories, see page 680 and 683.
4. For dimensions, see page 685.
5. **Pilot lights do not come with anti-rotation ring.**
6. Operator models come with operator and lens.
7. **Yellow pilot light comes with white LED.**

## Part Number Structure

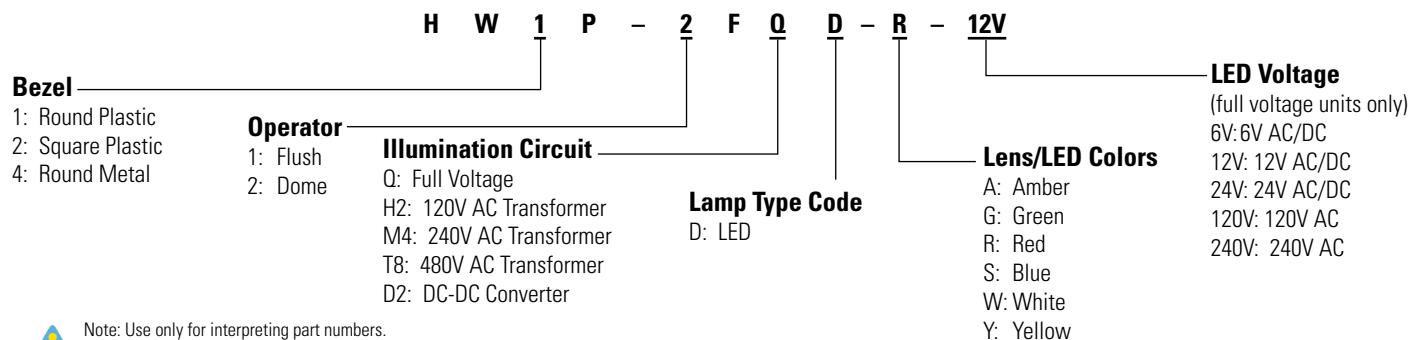

Note: Use only for interpreting part numbers. Do not use for developing part numbers.

## Pilot Lights (Replacement Parts)

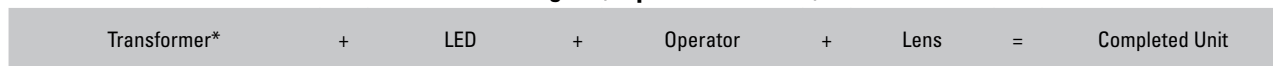

(not applicable for full voltage units)

### Transformer Units

Style	Voltage	Part Number
	120V AC	HW-FH20
	240V AC	HW-FM40
	480V AC	HW-FT80
(6V secondary voltage)	110V DC†	HW-RD0*

1. \*DC-DC converter can only be used with HW1P-100 and HW2P-100 operators  
2. † DC-DC converter voltage input from 90-140V DC.

### LED Lamps

Style	Voltage	Part Number
	6V AC/DC	LSTD-6Ⓞ
	12V AC/DC	LSTD-1Ⓞ
	24V AC/DC	LSTD-2Ⓞ
	120V AC	LSTD-H2Ⓞ
	240V AC	LSTD-M4Ⓞ

1. In place of Ⓞ, specify the LED Color Code.  
2. The LED contains a current-limiting resistor and reverse polarity protection diodes.

### ② LED Color Code

Color	Code	Color	Code
Amber	A	Blue	S
Green	G	White	W
Red	R		

For yellow lens use white LED.

### Operators

Style	Type	Plastic Bezel	Metal Bezel
Round Flush 	Full Voltage	Finger-Safe	HW1P-1FQ0
	Transformer	Finger-Safe	HW1P-10
		Used for DC-DC converter only	HW1P-100
Dome 	Full Voltage	Finger-Safe	HW1P-2FQ0
	Transformer	Finger-Safe	HW1P-20
		Used for DC-DC converter only	HW1P-200
Square Flush 	Full Voltage	Finger-Safe	HW2P-1FQ0
	Transformer	Finger-Safe	HW2P-10
		Used for DC-DC converter only	HW2P-100

1. Transformer type requires separate transformer & LED. Must select correct transformer bases. Use 6V LEDs.  
2. Full voltage type only requires LED.

### Lenses

Style	Part Number
Round/Flush 	HW1A-P1-Ⓞ
Dome 	HW1A-P2-Ⓞ
Square/Flush 	HW2A-P1-Ⓞ

In place of Ⓞ, specify the Lens Color Code.

### ③ Lens Color Code

Color	Code
Amber	A
Green	G
Red	R
Blue	S
White	W
Yellow	Y

For yellow lens use white LED.



Illuminated Round Pushbuttons (Assembled)



Illuminated Full Voltage Pushbuttons



Contacts	Flush		Extended		Extended w/ Full Shroud	
	Plastic Bezel	Metal Bezel	Plastic Bezel	Metal Bezel	Plastic Bezel	Metal Bezel
Momentary Operator Only 1NO 1NC 1NO-1NC 2NO	HW1L-M1-②	HW4L-M1-②	HW1L-M2-②	HW4L-M2-②	HW1L-MF2-②	HW4L-MF2-②
	HW1L-M1F10QD-②-③	HW4L-M1F10QD-②-③	HW1L-M2F10QD-②-③	HW4L-M2F10QD-②-③	HW1L-MF2F10QD-②-③	HW4L-MF2F10QD-②-③
	HW1L-M1F01QD-②-③	HW4L-M1F01QD-②-③	HW1L-M2F01QD-②-③	HW4L-M2F01QD-②-③	HW1L-MF2F01QD-②-③	HW4L-MF2F01QD-②-③
	HW1L-M1F11QD-②-③	HW4L-M1F11QD-②-③	HW1L-M2F11QD-②-③	HW4L-M2F11QD-②-③	HW1L-MF2F11QD-②-③	HW4L-MF2F11QD-②-③
	HW1L-M1F20QD-②-③	HW4L-M1F20QD-②-③	HW1L-M2F20QD-②-③	HW4L-M2F20QD-②-③	HW1L-MF2F20QD-②-③	HW4L-MF2F20QD-②-③
Maintained Operator Only 1NO 1NC 1NO-1NC 2NO	HW1L-A1-②	HW4L-A1-②	HW1L-A2-②	HW4L-A2-②	HW1L-AF2-②	HW4L-AF2-②
	HW1L-A1F10QD-②-③	HW4L-A1F10QD-②-③	HW1L-A2F10QD-②-③	HW4L-A2F10QD-②-③	HW1L-AF2F10QD-②-③	HW4L-AF2F10QD-②-③
	HW1L-A1F01QD-②-③	HW4L-A1F01QD-②-③	HW1L-A2F01QD-②-③	HW4L-A2F01QD-②-③	HW1L-AF2F01QD-②-③	HW4L-AF2F01QD-②-③
	HW1L-A1F11QD-②-③	HW4L-A1F11QD-②-③	HW1L-A2F11QD-②-③	HW4L-A2F11QD-②-③	HW1L-AF2F11QD-②-③	HW4L-AF2F11QD-②-③
	HW1L-A1F20QD-②-③	HW4L-A1F20QD-②-③	HW1L-A2F20QD-②-③	HW4L-A2F20QD-②-③	HW1L-AF2F20QD-②-③	HW4L-AF2F20QD-②-③

Illuminated Transformer Pushbuttons



Contacts	Flush		Extended		Extended w/ Full Shroud	
	Plastic Bezel	Metal Bezel	Plastic Bezel	Metal Bezel	Plastic Bezel	Metal Bezel
Momentary Operator Only 1NO-1NC 2NO	HW1L-M1-②	HW4L-M1-②	HW1L-M2-②	HW4L-M2-②	HW1L-MF2-②	HW4L-MF2-②
	HW1L-M1F11-③D-②	HW4L-M1F11-③D-②	HW1L-M2F11-③D-②	HW4L-M2F11-③D-②	HW1L-MF2F11-③D-②	HW4L-MF2F11-③D-②
	HW1L-M1F20-③D-②	HW4L-M1F20-③D-②	HW1L-M2F20-③D-②	HW4L-M2F20-③D-②	HW1L-MF2F20-③D-②	HW4L-MF2F20-③D-②
Maintained Operator Only 1NO-1NC 2NO	HW1L-A1-②	HW4L-A1-②	HW1L-A2-②	HW4L-A2-②	HW1L-AF2-②	HW4L-AF2-②
	HW1L-A1F11-③D-②	HW4L-A1F11-③D-②	HW1L-A2F11-③D-②	HW4L-A2F11-③D-②	HW1L-AF2F11-③D-②	HW4L-AF2F11-③D-②
	HW1L-A1F20-③D-②	HW4L-A1F20-③D-②	HW1L-A2F20-③D-②	HW4L-A2F20-③D-②	HW1L-AF2F20-③D-②	HW4L-AF2F20-③D-②

- In place of ②, specify Lens/LED Color Code from table.
- In place of ③ specify Voltage Code from table.
- Light independent of switch position.
- For replacement part numbers, see page 651.
- For nameplates and accessories, see page 680 and 683.
- For dimensions, see page 685.
- For contact assembly part numbers, see page 685.
- Full voltage and transformer models use the same operator.
- Additional contact configurations available (up to 6 total contacts).
- Yellow pushbutton comes with white LED.**

② Lens/LED Color Code

Color	Code
Amber	A
Green	G
Red	R
Blue	S
White	W
Yellow	Y



Yellow LED not available. Use white LED for yellow lens.

③ Voltage Code

Full Voltage Models		Transformer Models	
Voltage	Code	Voltage	Code
6V AC/DC	6V	120V AC	H2
12V AC/DC	12V	240V AC	M4
24V AC/DC	24V	480V AC	T8
120V AC	120V		
240V AC	240V		

### Part Number Structure

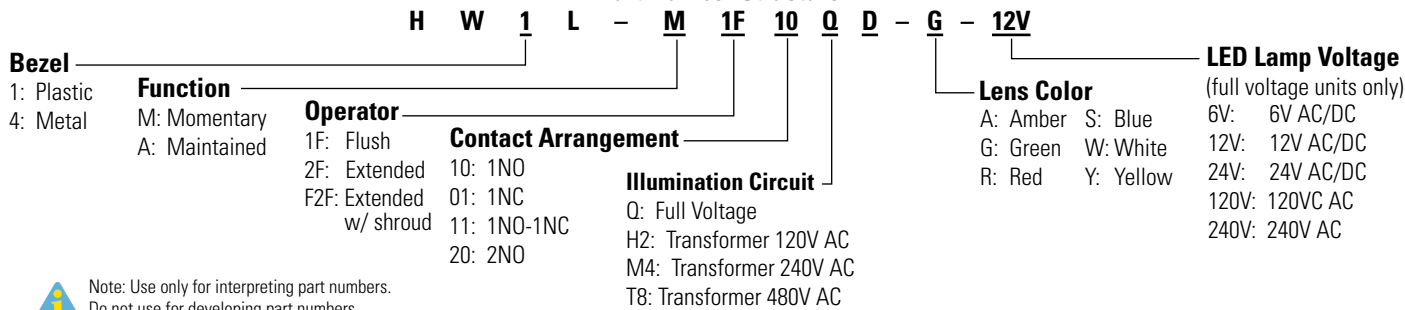

### Illuminated Round Pushbuttons (Replacement Parts)



**Note:** \*Transformer not needed with full voltage models.

### Lamp Circuit Components

Style	Description	Terminals	Part Number
	For use with HW-CBL on all illuminated pushbutton units. One required for each deck (pair) of contacts.		HW-LH3
	For use with odd number of contacts.	Finger-Safe	HW-DA1FBN
	For use with even number of contacts.	Finger-Safe	TW-DA1FB
	120VAC 240VAC 480VAC	Finger-Safe	TW-F126B TW-F246B TW-F486B
	110VDC		HW-L16D

- \*With spring-up terminals - to use spring-up terminal type, must use transformer type operator designed for spring-up transformer.
- \*\* DC-DC converter voltage input from 90-140V DC.

### Operators

Style	Plastic Bezel	Metal Bezel
	Momentary	HW1L-M0 HW4L-M0
	Maintained	HW1L-A0 HW4L-A0
	Momentary	HW1L-MF0 HW4L-MF0
	Maintained	HW1L-AF0 HW4L-AF0

### Contact Blocks

Style	Contacts	1NO	1NC
	Finger-Safe Spring-Up Terminal	HW-U10-F HW-U10R-F (early make)	HW-U01-F HW-U01R-F (late break)

- All assembled part numbers in catalog include standard finger-safe spring-up (HW-U...) contacts.

### Contact Block Mounting Adaptor

Style	Part Number
	HW-CBL

- Used to mount contact blocks to operator (first pair only).
- IEDEC strongly recommends using the safety lever lock to prevent heavy vibration or maintenance personnel from inadvertently unlocking contacts.

### Safety Lever Lock

Style	Part Number
	HW9Z-LS

### Lenses

Style	Part Number
	HW1A-L1-⊙
	HW1A-L2-⊙

- In place of ⊙, specify the Lens Color Code from previous page.

### Anti-Rotation Ring

Appearance	Part Number
	HW9Z-RL

- Use with notched panel cutout to prevent unit rotation.

### LED Lamps

Style	Voltage	Part Number
	6V AC/DC	LSTD-6⊙
	12V AC/DC	LSTD-1⊙
	24V AC/DC	LSTD-2⊙
	120V AC	LSTD-H2⊙
	240V AC	LSTD-M4⊙

- In place of ⊙, specify the LED Color Code.
- The LED contains a current-limiting resistor and reverse polarity protection diodes.
- Yellow LED not available, use white LED when using yellow lens.

Illuminated Mushroom & Square Pushbuttons (Assembled)



		40mm Mushroom Head		Square Flush	
		Contacts	Plastic Bezel	Metal Bezel	Plastic Bezel
Full Voltage	Momentary	<i>Operator Only</i> <sup>†</sup>	HW1L-M4-②	HW4L-M4-②	HW2L-M1-②
		1NO	HW1L-M4F10QD-②-③	HW4L-M4F10QD-②-③	HW2L-M1F10QD-②-③
		1NC	HW1L-M4F01QD-②-③	HW4L-M4F01QD-②-③	HW2L-M1F01QD-②-③
		1NO-1NC	HW1L-M4F11QD-②-③	HW4L-M4F11QD-②-③	HW2L-M1F11QD-②-③
		2NO	HW1L-M4F20QD-②-③	HW4L-M4F20QD-②-③	HW2L-M1F20QD-②-③
	Maintained	<i>Operator Only</i> <sup>†</sup>	HW1L-A4-②	HW4L-A4-②	HW2L-A1-②
		1NO	HW1L-A4F10QD-②-③	HW4L-A4F10QD-②-③	HW2L-A1F10QD-②-③
		1NC	HW1L-A4F01QD-②-③	HW4L-A4F01QD-②-③	HW2L-A1F01QD-②-③
		1NO-1NC	HW1L-A4F11QD-②-③	HW4L-A4F11QD-②-③	HW2L-A1F11QD-②-③
		2NO	HW1L-A4F20QD-②-③	HW4L-A4F20QD-②-③	HW2L-A1F20QD-②-③
Transformer	Momentary	1NO-1NC	HW1L-M4F11③D-②	HW4L-M4F11③D-②	HW2L-M1F11③D-②
		2NO	HW1L-M4F20③D-②	HW4L-M4F20③D-②	HW2L-M1F20③D-②
	Maintained	1NO-1NC	HW1L-A4F11③D-②	HW4L-A4F11③D-②	HW2L-A1F11③D-②
		2NO	HW1L-A4F20③D-②	HW4L-A4F20③D-②	HW2L-A1F20③D-②



- <sup>†</sup> Full voltage and transformer units use the same operator.
- In place of ②, specify the Lens/LED Color Code from table.
- In place of ③ specify the Voltage Code from table.
- Light independent of switch position
- For nameplates and accessories, see page 680. and 683.
- For dimensions, see page 685.
- For contact assembly part numbers, see page 685.
- Additional contact configurations available (up to 6 total contacts).
- 9. Yellow pushbutton comes with white LED.**

② Lens/LED Color Code

Color	Code
Amber	A
Green	G
Red	R
Blue	S
White	W
Yellow	Y*



- \*40mm mushroom lenses not available in yellow.
- Yellow LED not available. Use white LED for yellow lens.

③ Voltage Code

Full Voltage Models		Transformer Models	
Voltage	Code	Voltage	Code
6V AC/DC	6V	120V AC	H2
12V AC/DC	12V	240V AC	M4
24V AC/DC	24V	480V AC	T8
120V AC	120V		
240V AC	240V		

Part Number Structure

H W 1 L - M 1 F 10 Q D - G - 12V

**Bezel**  
 1: Round Plastic  
 2: Square Plastic  
 4: Round Metal

**Function**  
 M: Momentary  
 A: Maintained

**Operator**  
 1: Square Flush  
 4: Mushroom

**Contact Arrangement**  
 10: 1NO  
 01: 1NC  
 11: 1NO-1NC  
 20: 2NO

**Illumination Circuit**  
 Q: Full Voltage  
 H2: Transformer 120V AC  
 M4: Transformer 240V AC  
 T8: Transformer 480V AC

**Lens Color**  
 A: Amber S: Blue  
 G: Green W: White  
 R: Red Y: Yellow

**Voltage**  
 (full voltage units only)  
 6V: 6V AC/DC  
 12V: 12V AC/DC  
 24V: 24V AC/DC  
 120V: 120V AC  
 240V: 240V AC

Note: Use only for interpreting part numbers. Do not use for developing part numbers.

Illuminated Mushroom & Square Pushbuttons (Replacement Parts)

Transformer\* + Contact Blocks + Lead Holder + Adaptor† + Safety Lever Lock + LED + Anti-Rotation Ring + Operator + Lens = Completed Unit

\*Transformer not needed with full voltage models.

Lamp Circuit Components

Style	Description	Terminals	Part Number
Lead Holder	For use with HW-CBL on all illuminated pushbutton units. One required for each deck (pair) of contacts.		HW-LH3
Dummy Block with Full Voltage Adaptor	For use with odd number of contacts.	Finger-Safe	HW-DA1FBN
Full Voltage Adaptor	For use with even number of contacts.	Finger-Safe	TW-DA1FB
Transformer Unit (6V secondary voltage)	120VAC 240VAC 480VAC	Finger-Safe	TW-F126B TW-F246B TW-F486B
DC-DC Converter	110VDC		HW-L16D

- \*With spring-up terminals - to use spring-up terminal type, must use transformer type operator designed for spring-up transformer.
- \*\* DC-DC converter voltage input from 90-140V DC.

Operators

Style	Plastic Bezel	Metal Bezel
ø40mm Mushroom	Momentary	HW1L-M0L HW4L-M0L
	Maintained	HW1L-A0L HW4L-A0L
Square	Momentary	HW2L-M0
	Maintained	HW2L-A0

Contact Blocks

Style	Contacts	1NO	1NC
Finger-Safe Spring-Up Terminal		HW-U10-F HW-U10R-F (early make)	HW-U01-F HW-U01R-F (late break)

- All assembled part numbers in catalog include standard finger-safe spring-up contacts (HW-U...).

Contact Block Mounting Adaptor

Style	Part Number
	HW-CBL

- Used to mount contact blocks to operator (first pair only).
- IDEC strongly recommends using the safety lever lock to prevent heavy vibration or maintenance personnel from inadvertently unlocking contacts.

Anti-Rotation Ring

Appearance	Part Number
	HW9Z-RL

- Use with notched panel cutout to prevent unit rotation.

Safety Lever Lock

Style	Part Number
	HW9Z-LS

Lenses

Style	Part Number
ø40mm Mushroom Lens	ALW4BLU-⊙*
Square Flush	HW2A-L1-⊙

- In place of ⊙, specify the Lens Color Code.
- \*Mushroom lens not available in yellow.

LED Lamps

Style	Voltage	Part Number
LED	6V AC/DC	LSTD-6⊙
	12V AC/DC	LSTD-1⊙
	24V AC/DC	LSTD-2⊙
	120V AC	LSTD-H2⊙
	240V AC	LSTD-M4⊙

- In place of ⊙, specify the LED Color Code.
- The LED contains a current-limiting resistor and reverse polarity protection diodes.
- Yellow LED not available, use white LED when using yellow lens.

**Selector Switches 2-Position (Assembled)**



**2-Position Selector Switches**

Contact	Mounting	Operator Position		Handle	Maintained	Spring Return from Right
		L	R			
<i>Operator Only</i>				<i>Knob Lever</i>	<i>HWⓈS-2T HWⓈS-2L</i>	<i>HWⓈS-21T HWⓈS-21L</i>
1NO	1	0	X	<b>Knob Lever</b>	HWⓈS-2TF10 HWⓈS-2LF10	HWⓈS-21TF10 HWⓈS-21LF10
1NO- 1NC	1 2	0 X	X 0	<b>Knob Lever</b>	HWⓈS-2TF11 HWⓈS-2LF11	HWⓈS-21TF11 HWⓈS-21LF11
2NO	1 2	0 0	X X	<b>Knob Lever</b>	HWⓈS-2TF20 HWⓈS-2LF20	HWⓈS-21TF20 HWⓈS-21LF20
2NO- 2NC	1 2 3 4	X 0 X 0	0 X 0 X	<b>Knob Lever</b>	HWⓈS-2TF22 HWⓈS-2LF22	HWⓈS-21TF22 HWⓈS-21LF22



1. In place of Ⓢ enter 1 for plastic bezel or 4 for metal bezel.
2. For nameplates, see page 680.
3. All assembled part numbers in catalog include standard finger-safe spring-up (HW-U...) contacts.
4. Standard color for knob and lever is black.
5. Optional colors available for lever type. Must order in components. See next page for part numbers.
6. Additional contact configurations available (up to 6 total contacts).
7. For Truth Tables see page 693.

**Ⓢ Bezel Type**

Type	Code
Plastic	1
Metal	4

Part Number Structure

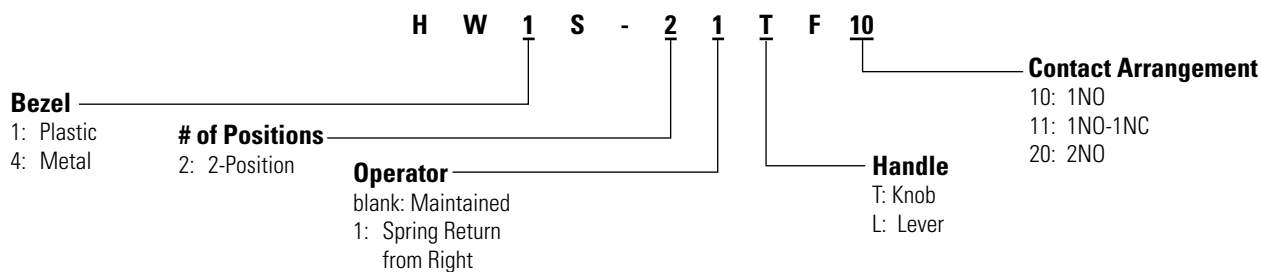

Note: Use only for interpreting part numbers. Do not use for developing part numbers.

Selector Switches 2-Position (Replacement Parts)



Contact Blocks

Style	Contacts	1NO	1NC
	Finger-Safe	HW-U10-F	HW-U01-F
	Spring-Up Terminal	HW-U10R-F (early make)	HW-U01R-F (late break)
	Dummy Block	HW-DB	

Anti-Rotation Ring

Style	Part Number
	HW9Z-RL

Use with notched panel cutout to prevent unit rotation.

Contact Block Mounting Adaptor

Style	Part Number
	HW-CB2C

- 1. Used to mount contact blocks to operator (first pair only).
- 2. IDEC strongly recommends using the safety lever lock to prevent heavy vibration or maintenance personnel from inadvertently unlocking contacts.

Operators

Style	Description	Handle	Plastic Bezel	Metal Bezel
	Maintained	Knob	HW1S-2T	HW4S-2T
		Lever	HW1S-2	HW4S-2
	Spring Return from Right	Knob	HW1S-21T	HW4S-21T
		Lever	HW1S-21	HW4S-21

- 1. Knob operator comes with black handle.
- 2. To order lever type, lever and inserts must be ordered separately, along with lever operator. See part numbers below.

Safety Lever Lock

Style	Part Number
	HW9Z-LS

Levers & Inserts

Style	Part Number
	ASWHHL-①
	TW-HC1-①

Standard lever color is black. Standard insert color is white.

① Handle/Insert Color Code

Color	Code
Black*	B
Blue	S
Green	G
Red	R
Yellow	Y
White†	W

- 1. \* Lever color inserts not available in black.
- 2. †Lever not available in white.

Selector Switches 3-Position (Assembled)



3-Position Selector Switches

Contact	Mounting	Operator Position			Handle	Maintained	Spring Return from Right	Spring Return from Left	Spring Return Two-Way
		L	C	R					
<i>Operator Only</i>					<i>Knob Lever</i>	<i>HW⊙S-3T* HW⊙S-3L</i>	<i>HW⊙S-31T HW⊙S-31L</i>	<i>HW⊙S-32T HW⊙S-32L</i>	<i>HW⊙S-33T HW⊙S-33L</i>
1NO-1NC	1	0	X	X	Knob Lever	HW⊙S-3TF11 HW⊙S-3LF11	HW⊙S-31TF11 HW⊙S-31LF11	HW⊙S-32TF11 HW⊙S-32LF11	HW⊙S-33TF11 HW⊙S-33LF11
	2	0	0	X					
2NO	1	X	0	0	Knob Lever	HW⊙S-3TF20 HW⊙S-3LF20	HW⊙S-31TF20 HW⊙S-31LF20	HW⊙S-32TF20 HW⊙S-32LF20	HW⊙S-33TF20 HW⊙S-33LF20
	2	0	0	X					
2NC	1	0	X	X	Knob Lever	HW⊙S-3TF02 HW⊙S-3LF02	HW⊙S-31TF02 HW⊙S-31LF02	HW⊙S-32TF02 HW⊙S-32LF02	HW⊙S-33TF02 HW⊙S-33LF02
	2	X	X	0					
2NO-1NC	1	X	0	0	Knob	HW⊙S-3JTF21N1	-	-	-
	2	0	0	X					
	3	0	X	0					
2NO-2NC	1	X	0	0	Knob	HW⊙S-3TF22	HW⊙S-31TF22	HW⊙S-32TF22	HW⊙S-33TF22
	2	0	0	X					
	3	0	X	X					
	4	X	X	0					
2NO-2NC	1	0	0	X	Knob	HW⊙S-3STF22N9	-	-	-
	2	X	0	0					
	3	X	X	0					
	4	0	0	X					
4NO	1	X	0	0	Knob	HW⊙S-3TF40	HW⊙S-31TF40	HW⊙S-32TF40	HW⊙S-33TF40
	2	0	0	X					
	3	X	0	0					
	4	0	0	X					
4NO	1	X	0	0	Knob	HW⊙S-3STF40N2	-	-	-
	2	0	X	X					
	3	X	0	0					
	4	0	0	X					
4NC	1	0	X	X	Knob	HW⊙S-3TF04	HW⊙S-31TF04	HW⊙S-32TF04	HW⊙S-33TF04
	2	X	X	0					
	3	0	X	X					
	4	X	X	0					

Ⓢ Bezel Type

Type	Code
Plastic	1
Metal	4

- In place of ⊙ enter 1 for plastic bezel or 4 for metal bezel.
- Knob operator includes black knob/lever operator includes black lever.
- \* Three position operator is available with three different cams.  
HW⊙S-3T: Maintained (standard cam)  
HW⊙S-3ST: Maintained (S cam)  
HW⊙S-3JT: Maintained (J cam)
- Operator cams are color coded (white=standard cam, red=S cam, black =J cam).
- For nameplates, see page 680.
- For contact assembly part numbers, see page 685
- All assembled part numbers in catalog include standard finger-safe spring-up (HW-U...) contacts.
- Standard color for knob and lever is black.
- Optional colors available for lever type. Must order in components. See next page for part numbers.
- Additional contact configurations available (up to 6 total contacts).
- For Truth Tables see page 693.

Part Number Structure

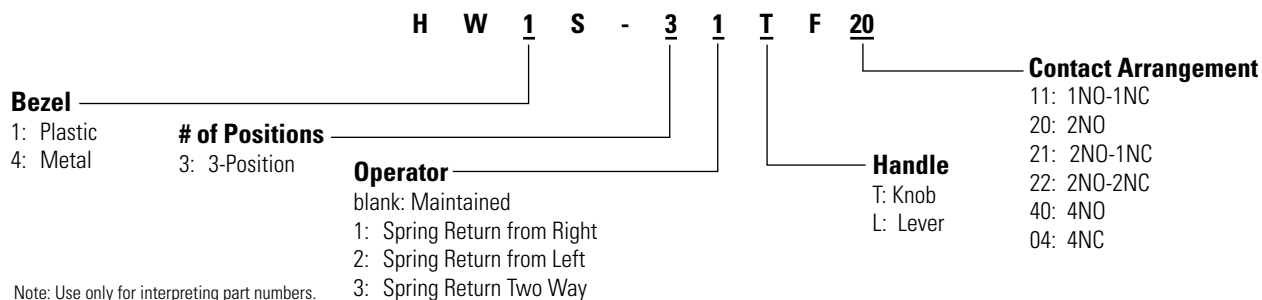

Selector Switches 3-Position (Replacement Parts)



Contact Blocks

Style	Contacts	1NO	1NC
	Finger-Safe Spring-Up Terminal	HW-U10-F	HW-U01-F
		HW-U10R-F (early make)	HW-U01R-F (late break)
	Dummy Block	HW-DB	

Anti-Rotation Ring

Style	Part Number
	HW9Z-RL

Use with notched panel cutout to prevent unit rotation.

Operators

Style	Description	Handle	Plastic Bezel	Metal Bezel
	Maintained (standard cam)	Knob	HW1S-3T	HW4S-3T
		Lever	HW1S-3	HW4S-3
	Maintained (S cam)	Knob	HW1S-3ST	HW4S-3ST
		Knob	HW1S-3JT	HW4S-3JT
	Spring Return from Right (standard cam)	Knob	HW1S-31T	HW4S-31T
		Lever	HW1S-31	HW4S-31
	Spring Return from Left (standard cam)	Knob	HW1S-32T	HW4S-32T
		Lever	HW1S-32	HW4S-32
	2-Way Spring Return (standard cam)	Knob	HW1S-33T	HW4S-33T
		Lever	HW1S-33	HW4S-33

1. Knob operator comes with black handle.  
 2. Three position knob operator is available with three different cams.  
 3. Operator cams are color coded (white=standard cam, red=S cam, black=J cam).  
 4. To order lever type, lever and inserts must be ordered separately, along with lever operator. See part numbers below.

Contact Block Mounting Adaptor

Style	Part Number
	HW-CB2C

1. Used to mount contact blocks to operator (first pair only).  
 2. IDEC strongly recommends using the safety lever lock to prevent heavy vibration or maintenance personnel from inadvertently unlocking contacts.

Safety Lever Lock

Style	Part Number
	HW9Z-LS

Levers & Inserts

Style	Part Number
	ASWHHL-⓪
	TW-HC1-⓪

Standard lever color is black. Standard insert color is white.

① Handle/Insert Color Code

Color	Code
Black*	B
Blue	S
Green	G
Red	R
Yellow	Y
White <sup>†</sup>	W

1. \* Lever color inserts not available in black.  
 2. <sup>†</sup>Lever not available in white.



Selector Switches 4- & 5-Position (Assembled)



4-Position Selector Switches

Contact	Mounting	Operator Position				Handle	Maintained
		1	2	3	4		
<i>Operator Only</i>						Knob Lever	HWⓈS-4T HWⓈS-4L
1NO- 2NC	1	X	0	0	0	Knob Lever	HWⓈS-4TF12 HWⓈS-4LF12
	2	0	X	0	0		
	3	0	0	X	0		
	4	0	0	0	0		
1NO- 3NC	1	0	X	X	X	Knob Lever	HWⓈS-4TF13N6 HWⓈS-4LF13N6
	2	0	X	0	0		
	3	0	0	X	0		
	4	0	0	0	X		
2NO- 2NC	1	X	0	0	0	Knob Lever	HWⓈS-4TF22N3 HWⓈS-4LF22N3
	2	0	X	0	0		
	3	0	0	X	0		
	4	0	0	0	X		

5-Position Selector Switch

Contact	Mounting	Operator Position					Handle	Maintained
		1	2	3	4	5		
<i>Operator Only</i>						Knob Lever	HWⓈS-5T HWⓈS-5L	
2NO- 2NC	1	X	0	0	0	0	Knob Lever	HWⓈS-5TF22N3 HWⓈS-5LF22N3
	2	0	X	0	0	0		
	3	0	0	0	X	0		
	4	0	0	0	0	X		



1. In place of Ⓢ enter 1 for plastic bezel or 4 for metal bezel.
2. Knob operator includes black knob/lever operator includes black lever.
3. For nameplates, see page 680.
4. For contact assembly part numbers, see page 685.
5. Five position circuit cannot be made to make five independent contact closures.
6. All assembled part numbers in catalog include standard finger-safe spring-up (HW-U...) contacts.
7. Standard color for knob and lever is black.
8. Optional colors available for lever type. Must order in components. See next page for part numbers.
9. Additional contact configurations available (up to 6 total contacts).
10. For Truth Tables see page 693.

Ⓢ Bezel Type

Type	Code
Plastic	1
Metal	4

Switches & Pilot Devices

Signaling Lights

Relays & Sockets

Timers

Contactors

Terminal Blocks

Circuit Breakers

Part Number Structure

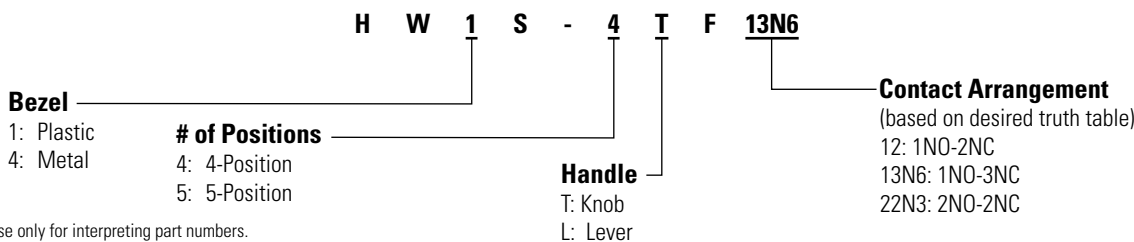

Note: Use only for interpreting part numbers.  
Do not use for developing part numbers.

Selector Switches 4- & 5-Position (Replacement Parts)



Contact Blocks

Style	Contacts	1NO	1NC
	Finger-Safe Spring-Up Terminal	HW-U10-F	HW-U01-F
		HW-U10R-F (early make)	HW-U01R-F (late break)
	Dummy Block	HW-DB	

Anti-Rotation Ring

Style	Part Number
	HW9Z-RL

Use with notched panel cutout to prevent unit rotation.

Operators

Style	Position	Description	Handle	Plastic Bezel	Metal Bezel
	4	Maintained	Knob	HW1S-4T	HW4S-4T
			Lever	HW1S-4	HW4S-4
	5	Maintained	Knob	HW1S-5T	HW4S-5T
			Lever	HW1S-5	HW4S-5

1. Knob operator comes with black handle.  
2. To order lever type, lever and inserts must be ordered separately, along with lever operator. See part numbers below.

Contact Block Mounting Adaptor

Style	Part Number
	HW-CB2C

1. Used to mount contact blocks to operator (first pair only).  
2. IDEC strongly recommends using the safety lever lock to prevent heavy vibration or maintenance personnel from inadvertently unlocking contacts.

Safety Lever Lock

Style	Part Number
	HW9Z-LS

Levers & Inserts

Style	Part Number
	Lever ASWHHL-⓪
	Lever Color Insert TW-HC1-⓪

Standard lever color is black. Standard insert color is white.

① Handle/Insert Color Code



Color	Code
Black*	B
Blue	S
Green	G
Red	R
Yellow	Y
White†	W

1. \* Lever color inserts not available in black.  
2. †Lever not available in white.

Key Switches 2-Position (Assembled)



2-Position Key Switches

Contact	Mounting	Operator Position		Maintained	Spring Return from Right
		L	R	L 	L 
<i>Operator Only</i>					
1NO	1	0	X	HW⊙K-2AF10	HW⊙K-21BF10
1NO-1NC	1	0	X	HW⊙K-2AF11	HW⊙K-21BF11
	2	X	0		
2NO	1	0	X	HW⊙K-2AF20	HW⊙K-21BF20
	2	0	X		
2NO-2NC	1	0	X	HW⊙K-2AF22	HW⊙K-21BF22
	2	X	0		
	3	0	X		
	4	X	0		

- 1. In place of ⊙ enter 1 for plastic bezel or 4 for metal bezel.
- 2. Key is removable in all maintained positions. Other key removable options available.
- 3. Two keys are supplied with all switches.
- 4. All standard operators are keyed alike.
- 5. Other key removable options available. See table below
- 6. For nameplates, see page 680.
- 7. For contact assembly part numbers, see page 685.
- 8. Key is retained in "Spring Return" position.
- 9. All assembled part numbers in catalog include finger-safe spring-up (HW-U...) contacts.
- 10. Additional contact configurations available (up to 6 total contacts).
- 11. For Truth Tables see page 685.

⊙ Bezel Type

Type	Code
Plastic	1
Metal	4

Key Removable Option Codes

Code	Description
A	Key not retained in any position (removable in all positions)
B	Key retained in right position only (removable LEFT)
C	Key retained in left position only (removable RIGHT)

## Part Number Structure

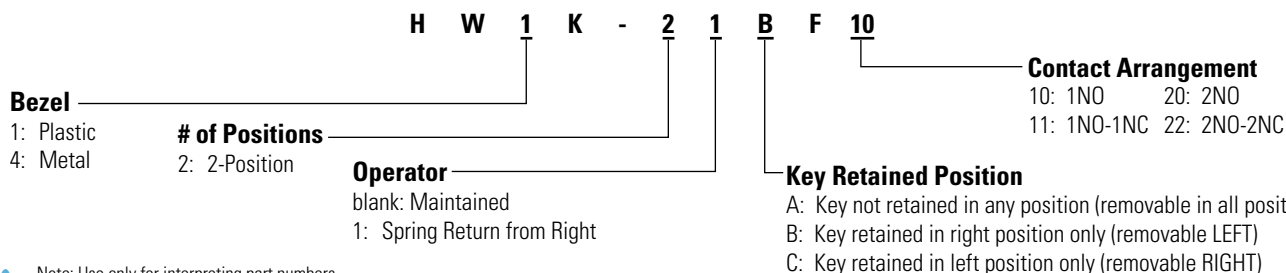

 Note: Use only for interpreting part numbers. Do not use for developing part numbers.

## Key Switches 2-Position (Replacement Parts)

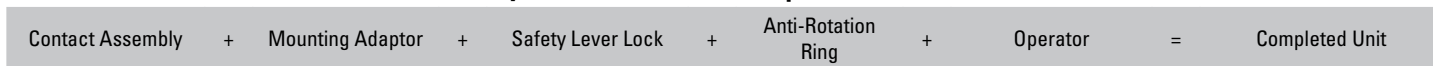

### Contact Blocks

Style	Contacts	1NO	1NC
	Finger-Safe Spring-Up Terminal	HW-U10-F	HW-U01-F
		HW-U10R-F (early make)	HW-U01R-F (late break)
	Dummy Block	HW-DB	

### Safety Lever Lock

Style	Part Number
	HW9Z-LS

### Anti-Rotation Ring

Style	Part Number
	HW9Z-RL



Use with notched panel cutout to prevent unit rotation.

### Contact Block Mounting Adaptor

Style	Part Number
	HW-CB2C



- Used to mount contact blocks to operator (first pair only).
- IDEC strongly recommends using the safety lever lock to prevent heavy vibration or maintenance personnel from inadvertently unlocking contacts.

### Operators

Style	Description	Plastic Bezel	Metal Bezel
	Maintained	HW1K-2A	HW4K-2A
	Maintained, key removed left only	HW1K-2B	HW4K-2B
	Spring Return from Right	HW1K-21B	HW4K-21B
	Maintained, key removed right only	HW1K-2C	HW4K-2C



- Operator includes two keys.
- All standard operators are keyed alike.

Key Switches 3-Position (Assembled)



3-Position Key Switches

Contact	Mounting	Operator Position			Maintained	Spring Return from Right	Spring Return from Left	Spring Return Two Way
		L	C	R				
<i>Operator Only</i>					HW⊙K-3A*	HW⊙K-31B	HW⊙K-32C	HW⊙K-33D
1NO-1NC	1	0	X	X	HW⊙K-3AF11	HW⊙K-31BF11	HW⊙K-32CF11	HW⊙K-33DF11
	2	0	0	X				
2NO	1	X	0	0	HW⊙K-3AF20	HW⊙K-31BF20	HW⊙K-32CF20	HW⊙K-33DF20
	2	0	0	X				
2NC	1	0	X	X	HW⊙K-3AF02	HW⊙K-31BF02	HW⊙K-32CF02	HW⊙K-33DF02
	2	X	X	0				
2NO-1NC	1	X	0	0	HW⊙K-3JAF21N1	-	-	-
	2	0	0	X				
	3	0	X	0				
2NO-2NC	1	X	0	0	HW⊙K-3AF22	HW⊙K-31BF22	HW⊙K-32CF22	HW⊙K-33DF22
	2	0	0	X				
	3	0	X	X				
	4	X	X	0				
2NO-2NC	1	0	0	X	HW⊙K-3SAF22N9	-	-	-
	2	X	0	0				
	3	X	X	0				
	4	0	0	X				
4NO	1	X	0	0	HW⊙K-3AF40	HW⊙K-31BF40	HW⊙K-32CF40	HW⊙K-33DF40
	2	0	0	X				
	3	X	0	0				
	4	0	0	X				
4NO	1	X	0	0	HW⊙K-3SAF40N2	-	-	-
	2	0	X	X				
	3	X	0	0				
	4	0	0	X				
4NC	1	0	X	X	HW⊙K-3AF04	HW⊙K-31BF04	HW⊙K-32CF04	HW⊙K-33DF04
	2	X	X	0				
	3	0	X	X				
	4	X	X	0				

Ⓢ Bezel Type

Type	Code
Plastic	1
Metal	4

- In place of ⊙ enter 1 for plastic bezel or 4 for metal bezel.
- Key is removable in all maintained positions. Other key removable options available.
- Two keys are supplied with all switches.
- All standard operators are keyed alike.
- Other key removable options available. See table to the right.
- \* Operator is available with three different cams.  
HW⊙K-3A: Maintained (standard cam)  
HW⊙K-3SA: Maintained (Cam S)  
HW⊙K-3JA: Maintained (Cam J)
- For nameplates, see page 680.

- For contact assembly part numbers, see page 685.
- All assembled part numbers in catalog include standard Finger-Safe spring-up (HW-U...) contacts.
- Additional contact configurations available (up to 6 total contacts).
- For Truth Tables see page 693.

Key Removable Option Codes

Code	Description
A	Key not retained in any position (removable in all positions)
B	Key retained in right position only
C	Key retained in left position only
D	Key retained in left and right (3 position only)
E	Key retained in center only (3 position only)
G	Key retained right and center (3 position only)
H	Key retained left and center (3 position only)

Part Number Structure

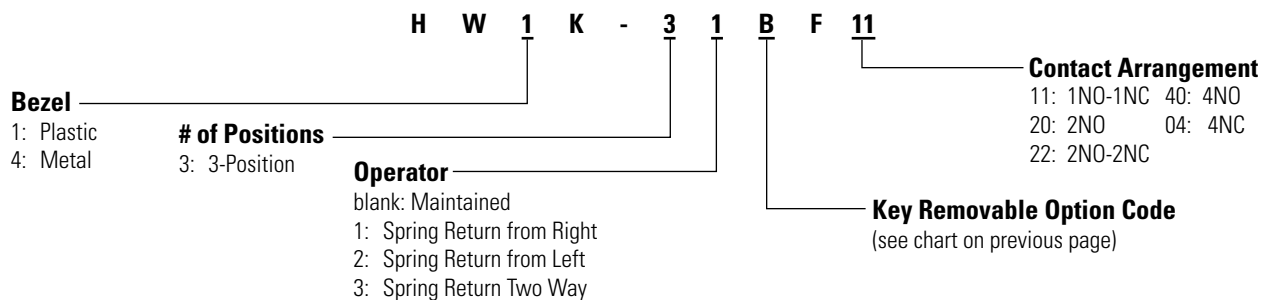

Note: Use only for interpreting part numbers. Do not use for developing part numbers.

Key Switches 3-Position (Replacement Parts)

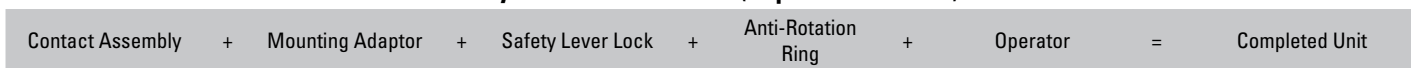

Contact Blocks

Style	Contacts	1NO	1NC
	Finger-Safe Spring-Up Terminal	HW-U10-F	HW-U01-F
		HW-U10R-F (early make)	HW-U01R-F (late break)
	Dummy Block	HW-DB	

Safety Lever Lock

Style	Part Number
	HW9Z-LS

Anti-Rotation Ring

Style	Part Number
	HW9Z-RL

Use with notched panel cutout to prevent unit rotation.

Contact Block Mounting Adaptor

Style	Part Number
	HW-CB2C

- 
- Used to mount contact blocks to operator (first pair only).
  - IDEC strongly recommends using the safety lever lock to prevent heavy vibration or maintenance personnel from inadvertently unlocking contacts.

Operators

Style	Description	Plastic Bezel	Metal Bezel
	Maintained (standard cam)	HW1K-3A	HW4K-3A
	Maintained (S cam)	HW1K-3SA	HW4K-3SA
	Maintained (J cam)	HW1K-3JA	HW4K-3JA
	Spring Return from Right (standard cam)	HW1K-31B	HW4K-31B
	Spring Return from Left (standard cam)	HW1K-32C	HW4K-32C
	2-Way Spring Return (standard cam)	HW1K-33D	HW4K-33D

- 
- Operator includes two keys.
  - All standard operators are keyed alike.
  - Other key removable options available. See table on previous page.
  - Key not removable from spring-returned position

Illuminated Selector Switches 2-Position (Assembled)



2-Position Illuminated Selector Switches

Contact	Mounting	Style		Part Number			
		Operator Position		Type	Maintained	Spring Return from Right	
		L	R				
<i>Operator Only</i>					HW <sup>⑤</sup> F-2 <sup>②</sup>	HW <sup>⑤</sup> F-21 <sup>②</sup>	
1NO-1NC	1 2	0 X	X 0	Full Voltage	HW <sup>⑤</sup> F-2F11QD- <sup>②</sup> - <sup>③</sup>	HW <sup>⑤</sup> F-21F11QD- <sup>②</sup> - <sup>③</sup>	
				Transformer	120V	HW <sup>⑤</sup> F-2F11H2D- <sup>②</sup>	HW <sup>⑤</sup> F-21F11H2D- <sup>②</sup>
					240V	HW <sup>⑤</sup> F-2F11M4D- <sup>②</sup>	HW <sup>⑤</sup> F-21F11M4D- <sup>②</sup>
2NO	1 2	X 0	0 X	Full Voltage	HW <sup>⑤</sup> F-2F20QD- <sup>②</sup> - <sup>③</sup>	HW <sup>⑤</sup> F-21F20QD- <sup>②</sup> - <sup>③</sup>	
				Transformer	120V	HW <sup>⑤</sup> F-2F20H2D- <sup>②</sup>	HW <sup>⑤</sup> F-21F20H2D- <sup>②</sup>
					240V	HW <sup>⑤</sup> F-2F20M4D- <sup>②</sup>	HW <sup>⑤</sup> F-21F20M4D- <sup>②</sup>
2NO-2NC	1 2 3 4	0 X 0 X	X 0 X 0	Full Voltage	HW <sup>⑤</sup> F-2F22QD- <sup>②</sup> - <sup>③</sup>	HW <sup>⑤</sup> F-21F22QD- <sup>②</sup> - <sup>③</sup>	
				Transformer	120V	HW <sup>⑤</sup> F-2F22H2D- <sup>②</sup>	HW <sup>⑤</sup> F-21F22H2D- <sup>②</sup>
					240V	HW <sup>⑤</sup> F-2F22M4D- <sup>②</sup>	HW <sup>⑤</sup> F-21F22M4D- <sup>②</sup>
				480V	HW <sup>⑤</sup> F-2F22T8D- <sup>②</sup>	HW <sup>⑤</sup> F-21F22T8D- <sup>②</sup>	

- 1. In place of <sup>②</sup> specify Lens/LED color code.
- 2. In place of <sup>③</sup> specify Full Voltage code.
- 3. In place of <sup>⑤</sup> enter 1 for plastic bezel or 4 for metal bezel.
- 4. For nameplates, see page 680.
- 5. For contact assembly part numbers, see page 685.
- 6. Light is independent of switch position.
- 7. All assembled part numbers in catalog include standard Finger-Safe spring-up (HW-U...) contacts.
- 8. Yellow selector switch comes with white LED.**
- 9. Additional contact configurations available (up to 6 total contacts).
- 10. For Truth Tables see page 693.

<sup>②</sup> Lens/LED Color Code

Color	Code
Amber	A
Green	G
Red	R
Blue	S
White	W
Yellow	Y

<sup>③</sup> Full Voltage Code

Full Voltage Models	
Voltage	Code
6VAC/DC	6V
12VAC/DC	12V
24VAC/DC	24V
120V AC	120V
240V AC	240V

<sup>⑤</sup> Bezel Code

Type	Code
Plastic	1
Metal	4

### Part Number Structure

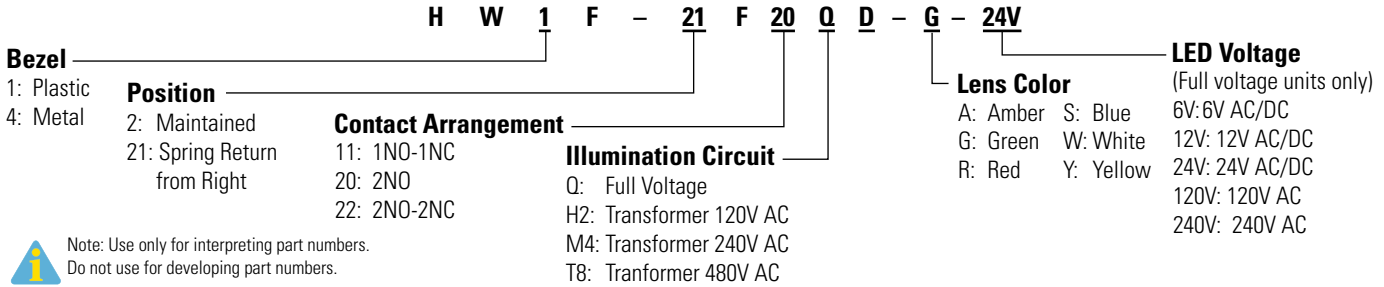

### Illuminated Selector Switches 2-Position (Replacement Parts)

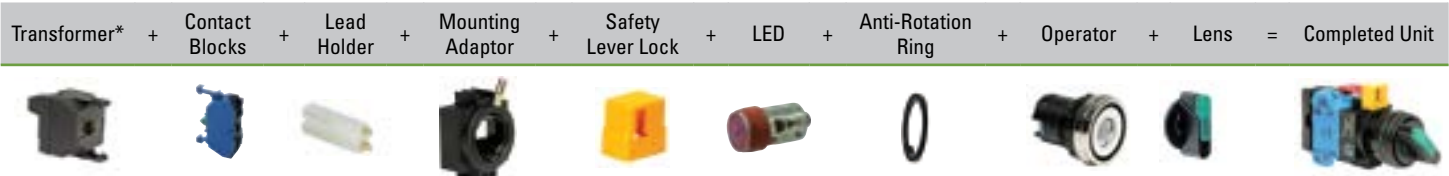

**Note:** \*Transformer not needed with full voltage models.

### Lamp Circuit Components

Style	Description	Terminals	Part Number
	For use with HW-CBL on all illuminated pushbutton units. One required for each deck (pair) of contacts.		HW-LH3
	For use with odd number of contacts.	Finger-Safe	HW-DA1FBN
	For use with even number of contacts.	Finger-Safe	TW-DA1FB
	120VAC 240VAC 480VAC	Finger-Safe	TW-F126B TW-F246B TW-F486B
	110VDC		HW-L16D

- DC-DC converter features spring-up terminals.
- DC-DC converter applicable voltage range 90-140V DC.

### Operators

Style	Description	Plastic Bezel	Metal Bezel
	Maintained	HW1F-2	HW4F-2
	Spring return from right	HW1F-21	HW4F-21

**Note:** Illuminated knobs must be ordered separately.

### Contact Blocks

Style	Contacts	1NO	1NC
	Finger-Safe Spring-Up Terminal	HW-U10-F HW-U10R-F (early make)	HW-U01-F HW-U01R-F (late break)

### Contact Block Mounting Adaptor

Style	Part Number
	HW-CBL

- Used to mount contact blocks to operator (first pair only).
- IEEC strongly recommends using the safety lever lock to prevent heavy vibration or maintenance personnel from inadvertently unlocking contacts.

### Safety Lever Lock

Style	Part Number
	HW9Z-LS

### Illuminated Knob

Appearance	Part Number
	HW9Z-FDY-⊙

**Note:** In place of ⊙, specify the Color Code.

### ⊙ Lens/LED Color Code

Color	Code	Color	Code
Amber	A	Blue	S
Green	G	White	W
Red	R	Yellow	Y

### Anti-Rotation Ring

Style	Part Number
	HW9Z-RL

**Note:** Use with notched panel cutout to prevent unit rotation.

### Lamps

Style	Voltage	Part Number
	6V AC/DC	LSTD-6⊙
	12V AC/DC	LSTD-1⊙
	24V AC/DC	LSTD-2⊙
	120V AC	LSTD-H2⊙
	240V AC	LSTD-M4⊙

- In place of ⊙, specify the LED Color Code.
- The LED contains a current-limiting resistor and reverse polarity protection diodes.
- Use white LED for yellow lens. Yellow LED not available.



Illuminated Selector Switches 3-Position (Assembled)



3-Position Illuminated Selector Switches

Contact	Mounting	Style			Part Number					
		Operator Position			Type	Maintained	Spring Return from Right	Spring Return from Left	Spring Return Two-Way	
		L	C	R		L C R	L C R	L C R	L C R	
<i>Operator Only</i>						HW⊙F-3②	HW⊙F-31②	HW⊙F-32②	HW⊙F-33②	
1NO-1NC	1 2	0 0	X 0	X X	Full Voltage	HW⊙F-3F11QD-②-③	HW⊙F-31F11QD-②-③	HW⊙F-32F11QD-②-③	HW⊙F-33F11QD-②-③	
					Transformer	120V	HW⊙F-3F11H2D-②	HW⊙F-31F11H2D-②	HW⊙F-32F11H2D-②	HW⊙F-33F11H2D-②
						240V	HW⊙F-3F11M4D-②	HW⊙F-31F11M4D-②	HW⊙F-32F11M4D-②	HW⊙F-33F11M4D-②
480V	HW⊙F-3F11T8D-②	HW⊙F-31F11T8D-②	HW⊙F-32F11T8D-②	HW⊙F-33F11T8D-②						
2NO	1 2	X 0	0 0	0 X	Full Voltage	HW⊙F-3F20QD-②-③	HW⊙F-31F20QD-②-③	HW⊙F-32F20QD-②-③	HW⊙F-33F20QD-②-③	
					Transformer	120V	HW⊙F-3F20H2D-②	HW⊙F-31F20H2D-②	HW⊙F-32F20H2D-②	HW⊙F-33F20H2D-②
						240V	HW⊙F-3F20M4D-②	HW⊙F-31F20M4D-②	HW⊙F-32F20M4D-②	HW⊙F-33F20M4D-②
480V	HW⊙F-3F20T8D-②	HW⊙F-31F20T8D-②	HW⊙F-32F20T8D-②	HW⊙F-33F20T8D-②						
2NC	1 2	0 X	X X	X 0	Full Voltage	HW⊙F-3F02QD-②-③	HW⊙F-31F02QD-②-③	HW⊙F-32F02QD-②-③	HW⊙F-33F02QD-②-③	
					Transformer	120V	HW⊙F-3F02H2D-②	HW⊙F-31F02H2D-②	HW⊙F-32F02H2D-②	HW⊙F-33F02H2D-②
						240V	HW⊙F-3F02M4D-②	HW⊙F-31F02M4D-②	HW⊙F-32F02M4D-②	HW⊙F-33F02M4D-②
480V	HW⊙F-3F02T8D-②	HW⊙F-31F02T8D-②	HW⊙F-32F02T8D-②	HW⊙F-33F02T8D-②						
2NO-2NC	1 2 3 4	X 0 0 X	0 0 X X	0 X X 0	Full Voltage	HW⊙F-3F22QD-②-③	HW⊙F-31F22QD-②-③	HW⊙F-32F22QD-②-③	HW⊙F-33F22QD-②-③	
					Transformer	120V	HW⊙F-3F22H2D-②	HW⊙F-31F22H2D-②	HW⊙F-32F22H2D-②	HW⊙F-33F22H2D-②
						240V	HW⊙F-3F22M4D-②	HW⊙F-31F22M4D-②	HW⊙F-32F22M4D-②	HW⊙F-33F22M4D-②
480V	HW⊙F-3F22T8D-②	HW⊙F-31F22T8D-②	HW⊙F-32F22T8D-②	HW⊙F-33F22T8D-②						
4NO	1 2 3 4	X 0 X 0	0 0 0 0	0 X 0 X	Full Voltage	HW⊙F-3F40QD-②-③	HW⊙F-31F40QD-②-③	HW⊙F-32F40QD-②-③	HW⊙F-33F40QD-②-③	
					Transformer	120V	HW⊙F-3F40H2D-②	HW⊙F-31F40H2D-②	HW⊙F-32F40H2D-②	HW⊙F-33F40H2D-②
						240V	HW⊙F-3F40M4D-②	HW⊙F-31F40M4D-②	HW⊙F-32F40M4D-②	HW⊙F-33F40M4D-②
480V	HW⊙F-3F40T8D-②	HW⊙F-31F40T8D-②	HW⊙F-32F40T8D-②	HW⊙F-33F40T8D-②						
4NC	1 2 3 4	0 X 0 X	X X X X	X 0 X 0	Full Voltage	HW⊙F-3F04QD-②-③	HW⊙F-31F04QD-②-③	HW⊙F-32F04QD-②-③	HW⊙F-33F04QD-②-③	
					Transformer	120V	HW⊙F-3F04H2D-②	HW⊙F-31F04H2D-②	HW⊙F-32F04H2D-②	HW⊙F-33F04H2D-②
						240V	HW⊙F-3F04M4D-②	HW⊙F-31F04M4D-②	HW⊙F-32F04M4D-②	HW⊙F-33F04M4D-②
480V	HW⊙F-3F04T8D-②	HW⊙F-31F04T8D-②	HW⊙F-32F04T8D-②	HW⊙F-33F04T8D-②						



- In place of ⊙ specify Lens/LED color code.
- In place of ⊙ specify Full Voltage code.
- In place of ⊙ enter 1 for plastic bezel or 4 for metal bezel.
- For nameplates, see page 680.
- For contact assembly part numbers, see page 685.
- Light is independent of switch position.
- All assembled part numbers in catalog include standard Finger-Safe spring-up (HW-U..) contacts.
- Yellow selector switch comes with white LED.**
- Additional contact configurations available (up to 6 total contacts).
- For Truth Tables see page 693.

② Lens/LED Color

Color	Code
Amber	A
Green	G
Red	R
Blue	S
White	W
Yellow	Y

③ Full Voltage Code

Full Voltage Models	
Voltage	Code
6VAC/DC	6V
12VAC/DC	12V
24VAC/DC	24V
120V AC	120V
240V AC	240V

⑤ Bezel Code

Type	Code
Plastic	1
Metal	4

### Part Number Structure

H W 1 F - 31 F 20 Q D - G - 24V

**Bezel**  
1: Plastic  
4: Metal

**Position**  
3: Maintained  
31: Spring Return from Right  
32: Spring Return from Left  
33: Spring Return 2-Way

**Contact Arrangement**  
11: 1NO-1NC  
20: 2NO  
02: 2NC  
22: 2NO-2NC  
40: 4NO  
04: 4NC

**Illumination Circuit**  
Q: Full Voltage  
H2: Transformer 120V AC  
M4: Transformer 240V AC  
T8: Transformer 480V AC

**Lens Color**  
A: Amber  
G: Green  
R: Red  
S: Blue  
W: White  
Y: Yellow

**Full Voltage Code**  
6V: 6V AC/DC  
12V: 12V AC/DC  
24V: 24V AC/DC  
120V: 120V AC  
240V: 240V AC

Note: Use only for interpreting part numbers. Do not use for developing part numbers.

### Illuminated Selector Switches 3-Position (Replacement Parts)

Transformer\* + Contact Blocks + Lead Holder + Mounting Adaptor + Safety Lever Lock + LED + Anti-Rotation Ring + Operator + Lens = Completed Unit



\*Transformer not needed with full voltage models.

### Lamp Circuit Components

Style	Description	Terminals	Part Number
Lead Holder	For use with HW-CBL on all illuminated pushbutton units. One required for each deck (pair) of contacts.		HW-LH3
Dummy Block with Full Voltage Adaptor	For use with odd number of contacts.	Finger-Safe	HW-DA1FBN
Full Voltage Adaptor	For use with even number of contacts.	Finger-Safe	TW-DA1FB
Transformer Unit (6V secondary voltage)	120VAC 240VAC 480VAC	Finger-Safe	TW-F126B TW-F246B TW-F486B
DC-DC Converter	110VDC		HW-L16D

- DC-DC converter features spring-up terminals.
- DC-DC converter applicable voltage range 90-140V DC.

### Operators

Style	Description	Plastic Bezel	Metal Bezel
	Maintained	HW1F-3	HW4F-3
	Spring return from right	HW1F-31	HW4F-31
	Spring return from left	HW1F-32	HW4F-32
	2-Way spring return	HW1F-33	HW4F-33

Illuminated knobs must be ordered separately.

### Contact Blocks

Style	Contacts	1NO	1NC
Finger-Safe Spring-Up Terminal		HW-U10-F HW-U10R-F (early make)	HW-U01-F HW-U01R-F (late break)

### Contact Block Mounting Adaptor

Style	Part Number
	HW-CBL

- Used to mount contact blocks to operator (first pair only).
- IEEC strongly recommends using the safety lever lock to prevent heavy vibration or maintenance personnel from inadvertently unlocking contacts.

### Safety Lever Lock

Style	Part Number
	HW9Z-LS

### Illuminated Knob

Appearance	Part Number
	HW9Z-FDY-⊙

In place of ⊙, specify the Color Code.

### ⊙ Lens/LED Color Code

Color	Code	Color	Code
Amber	A	Blue	S
Green	G	White	W
Red	R	Yellow	Y

### Anti-Rotation Ring

Style	Part Number
	HW9Z-RL

Use with notched panel cutout to prevent unit rotation.

### Lamps

Style	Voltage	Part Number
	6V AC/DC	LSTD-6⊙
LED	12V AC/DC	LSTD-1⊙
	24V AC/DC	LSTD-2⊙
	120V AC	LSTD-H2⊙
	240V AC	LSTD-M4⊙

- In place of ⊙, specify the LED Color Code.
- The LED contains a current-limiting resistor and reverse polarity protection diodes.
- Use white LED for yellow lens. Yellow LED not available.

**Mono Lever Switches 2-Position (Assembled)**



**2-Position Mono Lever Switches**

Style	Part Number	Description
HW1M Standard Lever	HW1M-F1010-20	Maintained up and down
	HW1M-F2020-20	Spring return up and down
	HW1M-F1010-40	Maintained up and down
	HW1M-F2020-40	Spring return up and down
	HW1M-F0101-20	Maintained right and left
	HW1M-F0202-20	Spring return right and left
	HW1M-F0101-40	Maintained right and left
HW1M-L Interlocking Lever	HW1M-F0202-40	Spring return right and left
	HW1M-LF1010-20	Maintained up and down
	HW1M-LF2020-20	Spring return up and down
	HW1M-LF1010-40	Maintained up and down
	HW1M-LF2020-40	Spring return up and down
	HW1M-LF0101-20	Maintained right and left
	HW1M-LF0202-20	Spring return right and left
HW1M-LF0101-40	HW1M-LF0101-40	Maintained right and left
	HW1M-LF0202-40	Spring return right and left



All Assembled units with Finger-Safe spring-up (HW-U...) contacts

**Circuit Diagrams**

**2 Position Left/Right**

Circuit Number	Contact Mounting		Position		
	No.		Left	Center	Right
20	1	HW-U10-F	X	0	0
	2	HW-U10-F	0	0	X
40	1	HW-U10-F	X	0	0
	2	HW-U10-F	0	0	X
	3	HW-U10-F	X	0	0
	4	HW-U10-F	0	0	X

**2 Position Up/Down**

Circuit Number	Contact Mounting		Position		
	No.		Down	Center	Up
20	1	HW-U10-F	X	0	0
	2	HW-U10-F	0	0	X
40	1	HW-U10-F	X	0	0
	2	HW-U10-F	0	0	X
	3	HW-U10-F	X	0	0
	4	HW-U10-F	0	0	X

**Part Number Structure**

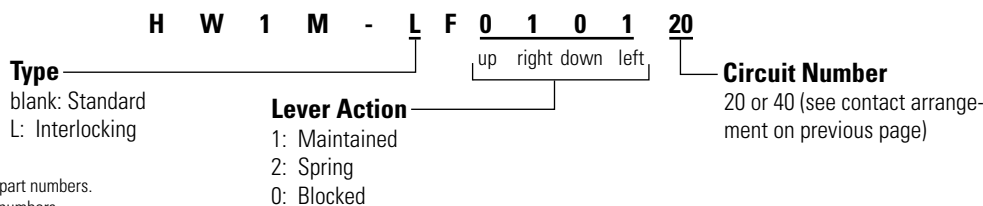

Note: Use only for interpreting part numbers. Do not use for developing part numbers.

**Mono Lever Switches 2-Position (Sub-assembled) Part Numbers**

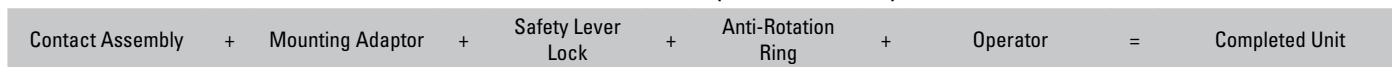

**Contact Blocks**

Style	Contacts	1NO	1NC
	Finger-Safe	HW-U10-F	HW-U01-F
	Spring-Up Terminal	HW-U10R-F (early make)	HW-U01R-F (late break)
	Dummy Block	HW-DB	

**Anti-Rotation Ring**

Style	Part Number
	HW9Z-RL

Use with notched panel cutout to prevent unit rotation.

**Operators**

Style	Description	Part Number
	Maintained Up/Down	HW1M-1010
	Spring return Up/Down	HW1M-2020
	Maintained Left/Right	HW1M-0101
	Spring return Left/Right	HW1M-0202
	Maintained Up/Down	HW1M-L1010
	Spring return Up/Down	HW1M-L2020
	Maintained Left/Right	HW1M-L0101
	Spring return Left/Right	HW1M-L0202

**Contact Block Mounting Adaptor**

Style	Part Number
	HW-CB2C

1. Used to mount contact blocks to operator (first pair only).  
 2. IDEC strongly recommends using the safety lever lock (included) to prevent heavy vibration or maintenance personnel from inadvertently unlocking contacts.

**Safety Lever Lock**

Style	Part Number
	HW9Z-LS

**Replacement Parts**

Item	Part Number
Black Cap 	HW9Z-CPM
Boot 	HW9Z-BLM (fits standard operator only)

**Mono Lever Switches 3- & 4-Position (Assembled)**



**3-Position**

Style	Part Number	Description
HW1M Standard Lever	HW1M-F0121-12N3	Maintained right and left, spring return down
	HW1M-F0222-12N3	Spring return right, down, left
HW1M-L Interlocking Lever	HW1M-LF0121-12N3	Maintained right and left, spring return down
	HW1M-LF0222-12N3	Spring return right, down, left

**Circuit Diagram**

Circuit Number	Contact Mounting		Position				
	No.		Down	Left	Center	Up	Right
12N3	1	HW-U01-F	0	0	0	0	X
	2	HW-U01-F	X	0	0	0	0
	3	HW-U10-F	0	X	0	0	0

**4-Position**

Style	Part Number	Description
HW1M Standard Lever	HW1M-F1111-22N9	Maintained all positions
	HW1M-F1212-22N9	Maintained up and down, spring left and right
	HW1M-2121-22N9	Spring up and down, maintained left and right
	HW1M-2222-22N9	Spring return all positions
HW1M-L Interlocking Lever	HW1M-LF1111-22N9	Maintained all positions
	HW1M-LF1212-22N9	Maintained up and down, spring left and right
	HW1M-LF2121-22N9	Spring up and down, maintained left and right
	HW1M-LF2222-22N9	Spring return all positions

**Circuit Diagram**

Circuit Number	Contact Mounting		Position				
	No.		Down	Left	Center	Up	Right
22N9	1	HW-U01-F	0	0	0	0	X
	2	HW-U01-F	X	0	0	0	0
	3	HW-U10-F	0	X	0	0	0
	4	HW-U10-F	0	0	0	X	0



All assembled part numbers in catalog include Finger-Safe spring-up (HW-U...) contacts.

Part Number Structure

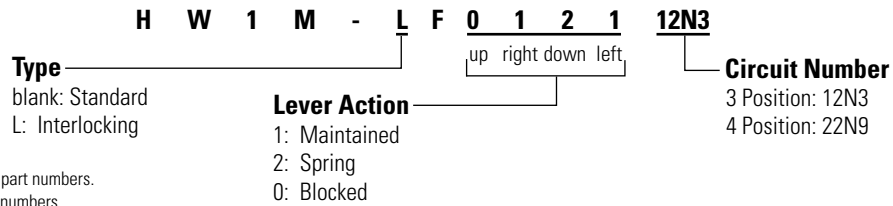

Note: Use only for interpreting part numbers. Do not use for developing part numbers.

Mono Lever Switches 3 & 4-Position (Sub-assembled) Part Numbers

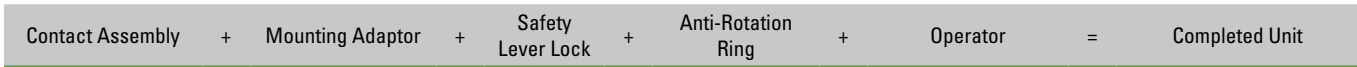

Contact Blocks

Style	Contacts	1NO	1NC
	Finger-Safe Spring-Up Terminal	HW-U10-F	HW-U01-F
		HW-U10R-F (early make)	HW-U01R-F (late break)
	Dummy Block	HW-DB	

Anti-Rotation Ring

Style	Part Number
	HW9Z-RL

Use with notched panel cutout to prevent unit rotation.

Operators

Style	Description	Part Number
	Combination, 3 position	HW1M-0121
	Spring return, 3 position	HW1M-0222
	Maintained, 4 position	HW1M-1111
	Combination, 4 position	HW1M-1212
	Combination, 4 position	HW1M-2121
	Spring return, 4 position	HW1M-2222
	Combination, 3 position	HW1M-L0121
	Spring return, 3 position	HW1M-L0222
	Maintained, 4 position	HW1M-L1111
	Combination, 4 position	HW1M-L1212
	Combination, 4 position	HW1M-L2121
	Spring return, 4 position	HW1M-L2222

Contact Block Mounting Adaptor

Style	Part Number
	HW-CB2C

1. Used to mount contact blocks to operator (first pair only).  
 2. IDEC strongly recommends using the safety lever lock (included) to prevent heavy vibration or maintenance personnel from inadvertently unlocking contacts.

Safety Lever Lock

Style	Part Number
	HW9Z-LS

Replacement Parts

Item	Part Number
Black Cap	HW9Z-CPM
Boot	HW9Z-BLM (fits standard operator only)

Pushbutton Selectors (Assembled)



2-Position Pushbutton Selectors

Cam	Contacts	Mounting	Operator Position				Part Number	
			Left		Right			
			Normal	Push	Normal	Push		
<b>A</b>	Operator Only						HW1R-2A-①	
	1NO-1NC	1	HW-U10-F	0	X	0	X	HW1R-2AF11-①
		2	HW-U01-F	X	0	0	0	
	2NO	1	HW-U10-F	0	X	0	X	HW1R-2AF20-①
2		HW-U10-F	0	X	X	X		
2NO-2NC	1	HW-U10-F	0	X	0	X	HW1R-2AF22-①	
	2	HW-U01-F	X	0	0	0		
	3	HW-U10-F	0	X	0	X		
	4	HW-U01-F	X	0	0	0		
<b>D</b>	Operator Only						HW1R-2D-①	
	2NO	1	HW-U10-F	0	X	0	0	HW1R-2DF20-①
		2	HW-U10-F	0	0	0	X	
	2NO-2NC	1	HW-U10-F	0	X	0	0	HW1R-2DF22N1-①
2		HW-U10-F	0	0	0	X		
3		HW-U01-F	X	0	X	X		
4		HW-U01-F	X	X	X	0		
<b>E</b>	Operator Only						HW1R-2E-①	
	2NO-2NC	1	HW-U10-F	0	X	0	0	HW1R-2EF22N1-①
		2	HW-U10-F	0	0	0	X	
		3	HW-U01-F	0	0	X	X	
4		HW-U01-F	X	X	0	0		
<b>F</b>	Operator Only						HW1R-2F-①	
	2NO-2NC	1	HW-U10-F	0	0	0	X	HW1R-2FF22N1-①
		2	HW-U10-F	0	X	0	0	
		3	HW-U01-F	0	0	X	0	
4		HW-U01-F	X	0	0	0		
<b>N</b>	Operator Only						HW1R-2N-①	
	2NO-2NC	1	HW-U01-F	0	0	X	0	HW1R-2NF22N2-①
		2	HW-U10-F	0	X	0	X	
		3	HW-U01-F	0	0	X	0	
4		HW-U10-F	0	X	0	X		
<b>T</b>	Operator Only						HW1R-2T-①	
	2NO-2NC	1	HW-U10-F	0	X	X		HW1R-2TF22N1-①
		2	HW-U10-F	0	X	X	Blocked	
		3	HW-U01-F	X	0	0		
4		HW-U01-F	X	0	0			

① Button Color Code

Color	Code	Color	Code
Black	B	White	W
Green	G	Yellow	Y
Red	R		
Blue	S		

1. All assembled part numbers in catalog include Finger-Safe spring-up (HW-U...) contacts.
2. Operator only models come with operator and button.

Part Number Structure

H W 1 R - 2 D F 22N1 - R

Operator

- A: Cam A
- D: Cam D
- E: Cam E
- F: Cam F
- N: Cam N
- T: Cam T

Contact Arrangement Code

- 11: 1NO-1NC
- 20: 2NO
- (For additional contact codes see previous page)

Button Colors

- B: Black
- G: Green
- R: Red
- S: Blue
- W: White
- Y: Yellow



Note: Use only for interpreting part numbers. Do not use for developing part numbers.

Pushbutton Selectors (Sub-assembled)

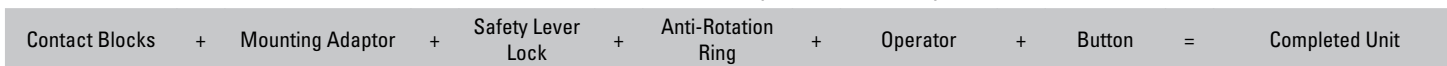

Contact Blocks

Style	Contacts	1NO	1NC
	Finger-Safe Spring-Up Terminal	HW-U10-F	HW-U01-F
		HW-U10R-F (early make)	HW-U01R-F (late break)
	Dummy Block	HW-DB	

Safety Lever Lock

Style	Part Number
	HW9Z-LS

Buttons

Style	Part Number
Round Flush	HW1A-B1-Ⓢ



In place of Ⓢ, specify the Button Color Code from table below.

Ⓢ Button Color Code

Color	Code	Color	Code
Black	B	White	W
Green	G	Yellow	Y
Red	R		
Blue	S		

Contact Block Mounting Adaptor

(safety lever lock included)

Style	Part Number
	HW-CB2C



- Used to mount contact blocks to operator (first pair only).
- IDEC strongly recommends using the safety lever lock (included) to prevent heavy vibration or maintenance personnel from inadvertently unlocking contacts.

Anti-Rotation Ring

Style	Part Number
	HW9Z-RL



Use with notched panel cutout to prevent unit rotation.

Operators

Style	Description	Part Number
	Cam A	HW1R-2A
	Cam D	HW1R-2D
	Cam E	HW1R-2E
	Cam F	HW1R-2F
	Cam N	HW1R-2N
	Cam T	HW1R-2T



### Dual Pushbutton Switches

**Key features:**

- Two pushbuttons and a pilot light are integrated into one space-saving ø22 mm control unit.
- Momentary and interlock types are available for pushbuttons. Interlock type prevents both buttons from being pressed at the same time.
- Pilot lights are available in full voltage and transformer with LED.
- IP40 protection, IP65 when using silicon boot.



**Applications:**

- Ideal for use as power switches and start/stop switches (available with I/ON and O/OFF markings on the buttons and a pilot light in the center).
- Interlock type prevents two pushbuttons from being pressed at the same time.



### Dual Pushbutton Switches (Assembled) Part Numbers

**Without Center Pilot Light**

Operation Type	Button Style	Image	Contact Arrangement		Part Number	Ⓔ Button Color Code	Ⓕ Legend Code		
			Top Button	Bottom Button					
Momentary	Flush (top) Flush (bottom)		1NO	1NC	HW7D-B11F1001-ⒺⒻ	GR: Green (top) Red (bottom)	Blank: Without legend		
			1NO	1NO	HW7D-B11F1010-ⒺⒻ				
			1NO-1NC	1NO-1NC	HW7D-B11F1111-ⒺⒻ				
			2NO	2NC	HW7D-B11F2002-ⒺⒻ				
			2NO	2NO	HW7D-B11F2020-ⒺⒻ				
Momentary	Flush (top) Extended (bottom)		1NO	1NC	HW7D-B12F1001-ⒺⒻ			WB: White (top) Black (bottom)	1: I/ON (top) O/OFF (bottom)
			1NO	1NO	HW7D-B12F1010-ⒺⒻ				
			1NO-1NC	1NO-1NC	HW7D-B12F1111-ⒺⒻ				
			2NO	2NC	HW7D-B12F2002-ⒺⒻ				
			2NO	2NO	HW7D-B12F2020-ⒺⒻ				
Interlock*	Flush (top) Flush (bottom)		1NO	1NC	HW7D-B21F1001-ⒺⒻ	WB: White (top) Black (bottom)	1: I/ON (top) O/OFF (bottom)		
			1NO	1NO	HW7D-B21F1010-ⒺⒻ				
			1NO-1NC	1NO-1NC	HW7D-B21F1111-ⒺⒻ				
			2NO	2NC	HW7D-B21F2002-ⒺⒻ				
			2NO	2NO	HW7D-B21F2020-ⒺⒻ				
	Flush (top) Extended (bottom)		1NO	1NC	HW7D-B22F1001-ⒺⒻ			WB: White (top) Black (bottom)	1: I/ON (top) O/OFF (bottom)
			1NO	1NO	HW7D-B22F1010-ⒺⒻ				
			1NO-1NC	1NO-1NC	HW7D-B22F1111-ⒺⒻ				
			2NO	2NC	HW7D-B22F2002-ⒺⒻ				
			2NO	2NO	HW7D-B22F2020-ⒺⒻ				

1. \*Interlock type prevents both top and bottom buttons from being pressed simultaneously.  
 2. Clear silicon rubber cover part number HW9Z-D7D.  
 3. Additional contact configurations available (up to 6 total contacts).

**With Center Pilot Light**

Operation Type	Button Style		Top Button	Bottom Button	Part Number
Momentary	Flush (Top) Flush (Bottom)	Flush (top) Flush (bottom)	1NO	1NC	HW7D-L11F1001②③-④⑤
			1NO	1NO	HW7D-L11F1010②③-④⑤
			1NO-1NC	1NO-1NC	HW7D-L11F1111②③-④⑤
			2NO	2NC	HW7D-L11F2002②③-④⑤
			2NO	2NO	HW7D-L11F2020②③-④⑤
	Flush (Top) Extended (Bottom)		1NO	1NC	HW7D-L12F1001②③-④⑤
			1NO	1NO	HW7D-L12F1010②③-④⑤
			1NO-1NC	1NO-1NC	HW7D-L12F1111②③-④⑤
			2NO	2NC	HW7D-L12F2002②③-④⑤
			2NO	2NO	HW7D-L12F2020②③-④⑤
Interlock*	Flush (Top) Flush (Bottom)	Flush (top) Extended (bottom)	1NO	1NC	HW7D-L21F1001②③-④⑤
			1NO	1NO	HW7D-L21F1010②③-④⑤
			1NO-1NC	1NO-1NC	HW7D-L21F1111②③-④⑤
			2NO	2NC	HW7D-L21F2002②③-④⑤
			2NO	2NO	HW7D-L21F2020②③-④⑤
	Flush (Top) Extended (Bottom)		1NO	1NC	HW7D-L22F1001②③-④⑤
			1NO	1NO	HW7D-L22F1010②③-④⑤
			1NO-1NC	1NO-1NC	HW7D-L22F1111②③-④⑤
			2NO	2NC	HW7D-L22F2002②③-④⑤
			2NO	2NO	HW7D-L22F2020②③-④⑤

- 1. \*Interlock type prevents both top and bottom buttons from being pressed simultaneously.
- 2. Clear silicon rubber cover part number HW9Z-D7D.
- 3. All assembled part numbers in catalog include Finger-Safe spring-up (HW-U...) contacts.

**② Pilot Light Illumination & Voltage Code**

Full Voltage	
Voltage	Code
6V AC/DC, LED	Q2
12V AC/DC, LED	Q3
24V AC/DC, LED	Q4
120V AC, LED	Q8
Step-Down Transformer (6V Secondary LED Voltage)	
Voltage	Code
120V AC, LED	H22
240V AC, LED	M42
480V AC, LED	T82

**③ Pilot Lamp Color Code**

Color	Code
Amber	A
Green	G
Red	R
Blue	S
White	W

**④ Pushbutton Color Code**

Color		Code
Top	Green	GR
Bottom	Red	
Top	White	WB
Bottom	Black	

**⑤ Engraving Codes**

Engraving		Code
No Engraving	Blank	
I/ON	Top	1
O/OFF	Bottom	

Switches & Pilot Devices

Signaling Lights

Relays & Sockets

Timers

Contactors

Terminal Blocks

Circuit Breakers

Switches & Pilot Devices

Signalizing Lights

Relays & Sockets

Timers

Contactors

Terminal Blocks

Circuit Breakers

**Part Number Structure**  
**H W 7 D - L 21 F 20 20 H22 R - GR 1**

**Pilot Light**

- Without Center Pilot Light
- With Center Pilot Light

**Button Arrangement**

- 1: Momentary (Flush/Flush)
- 12: Momentary (Flush/Extended)
- 21: Interlock (Flush/Flush)
- 22: Interlock (Flush/Extended)

**Contact Arrangement**

- Top Button**
- 01: 1NC
  - 02: 2NC
  - 10: 1NO
  - 20: 2NO
- Bottom Button**
- 01: 1NC
  - 02: 2NC
  - 10: 1NO
  - 20: 2NO

- Voltage Code**
- blank: without center pilot light
  - Q2: 6V LED
- Full Voltage\***
- Transformer\***
- H22: 120V AC LED
- \*For additional voltage codes, please see previous page

- Pilot Lamp Color**
- A: Amber
  - G: Green
  - R: Red
  - S: Blue
  - W: White
  - Y: Yellow
  - blank: without center pilot light

- Engraving Code**
- blank: No Engraving
  - 1: Top: I/ON
  - Bottom: O/OFF
- Pushbutton Color**
- GR: Top: Green
  - Bottom: Red
  - WB: Top: White
  - Bottom: Black

Note: Use only for interpreting part numbers. Do not use for developing part numbers.

**Dual Pushbutton Switches (Sub-assembled) Part Numbers**



**Lamp Circuit Components with Finger-Safe Terminals**

Style	Description	Part Number
	For use with HW-CBL on all illuminated pushbutton units. One required for each deck (pair) of contacts.	HW-LH3
	For use with odd number of contacts.	HW-DA1FBN
	For use with even number of contacts.	TW-DA1FB
	120VAC 240VAC 480VAC	TW-F126B TW-F246B TW-F486B

**Contact Blocks**

Style	Contacts	1NO	1NC
	Finger-Safe Spring-Up Terminal	HW-U10-F HW-U10R-F (early make)	HW-U01-F HW-U01R-F (late break)
	Dummy Block	HW-DB	

**Contact Block Mounting Adaptor**

Style	Part Number
Non-illuminated	HW-CB2C
Illuminated (with Pilot Light)	HW-CBL

1. Used to mount contact blocks to operator (first pair only).  
 2. IDEC strongly recommends using the safety lever lock (included) to prevent heavy vibration or maintenance personnel from inadvertently unlocking contacts.

**Lamps/Lens**

Style	Voltage	Part Number
	6V AC/DC	LSTD-6Ⓞ
	12V AC/DC	LSTD-1Ⓞ
	24V AC/DC	LSTD-2Ⓞ
	120V AC	LSTD-H2Ⓞ
Non-illuminated	240V AC	LSTD-M4Ⓞ
		HW9Z-B7B
Illuminated		HW9Z-L7W

1. In place of Ⓞ, specify the LED Color Code.  
 2. The LED contains a current-limiting resistor and reverse polarity protection diodes.

**Operators**

Style	Button	Part Number
	Flush (top)	HW7D-*11Ⓞ-Ⓞ
	Flush (bottom)	
	Flush (top)	HW7D-*12Ⓞ-Ⓞ
	Extended (bottom)	
	Flush (top)	HW7D-*21Ⓞ-Ⓞ
	Flush (bottom)	
	Flush (top)	HW7D-*22Ⓞ-Ⓞ
	Extended (bottom)	

Instead of \* insert:  
 B: Non-illuminated  
 L: Illuminated

**Safety Lever Lock**

Style	Part Number
	HW9Z-LS

**Anti-Rotation Ring**

Appearance	Part Number
	HW9Z-RL

Use with notched panel cutout to prevent unit rotation.

**Ⓞ Engraving Codes**

Engraving	Code
No Engraving	Blank
I/ON	Top
O/OFF	Bottom
	1

**Ⓞ LED Color Code**

Color	Code	Color	Code
Amber	A	Blue	S
Green	G	White	W
Red	R		

**Ⓞ Pushbutton Color Code**

Color	Code	Color	Code
Top: Green	GR	Top: White	WB
Bottom: Red		Bottom: Black	

Contact Arrangement			Contact Block		Top Button		Bottom Button		
Top Button	Bottom Button	Contact Code	Mounting Position	Type	Normal	Push	Normal	Push	
1NO	1NO	1010	1	NO		X			
			2	NO				X	
1NO	1NC	1001	1	NO		X			
			2	NC			X		
1NC	1NO	0110	1	NC	X				
			2	NO				X	
1NC	1NC	0101	1	NC	X				
			2	NC			X		
1NO	2NO	1020	1	NO		X			
			2	NO				X	
			3	Dummy					
			4	NO					X
1NO	1NO-1NC	1011	1	NO		X			
			2	NO				X	
			3	Dummy					
			4	NC				X	
1NO	2NC	1002	1	NO		X			
			2	NC			X		
			3	Dummy					
			4	NC				X	
1NC	2NO	0120	1	NC	X				
			2	NO				X	
			3	Dummy					
			4	NO					X
1NC	1NO-1NC	0111	1	NC	X				
			2	NO				X	
			3	Dummy					
			4	NC				X	
1NC	2NC	0102	1	NC	X				
			2	NC			X		
			3	Dummy					
			4	NC				X	
2NO	1NO	2010	1	NO		X			
			2	NO				X	
			3	NO		X			
			4	Dummy					
2NO	1NC	2001	1	NO		X			
			2	NC			X		
			3	NO		X			
			4	Dummy					
1NO-1NC	1NO	1110	1	NO		X			
			2	NO				X	
			3	NC	X				
			4	Dummy					
1NO-1NC	1NC	1101	1	NO		X			
			2	NC			X		
			3	NC	X				
			4	Dummy					

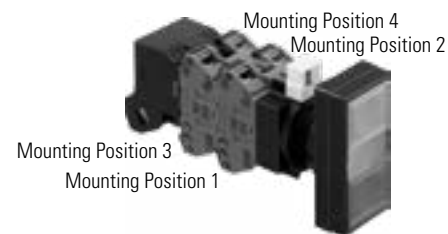

Switches & Pilot Devices

Signaling Lights

Relays & Sockets

Timers

Contactors

Terminal Blocks

Circuit Breakers

1. Transformers can have two or four contact blocks only.  
 2. Contact blocks 1 and 3 are actuated by the top button. Contact blocks 2 and 4 are actuated by the bottom button.

**Contact Arrangement Chart (con't)**

Contact Arrangement			Contact Block		Top Button		Bottom Button	
Top Button	Bottom Button	Contact Code	Mounting Position	Type	Normal	Push	Normal	Push
2NC	1NO	0210	1	NC	X			
			2	NO			X	
			3	NC	X			
			4	Dummy				
2NC	1NC	0201	1	NC	X			
			2	NC			X	
			3	NC	X			
			4	Dummy				
2NO	2NO	2020	1	NO		X		
			2	NO				X
			3	NO		X		
			4	NO				X
2NO	1NO-1NC	2011	1	NO		X		
			2	NO				X
			3	NO		X		
			4	NC				X
2NO	2NC	2002	1	NO		X		
			2	NC				X
			3	NO		X		
			4	NC				X
1NO-1NC	2NO	1120	1	NO		X		
			2	NO				X
			3	NC	X			
			4	NO				X
1NO-1NC	1NO-1NC	1111	1	NO		X		
			2	NO				X
			3	NC	X			
			4	NC				X
1NO-1NC	2NC	1102	1	NO		X		
			2	NC				X
			3	NC	X			
			4	NC				X
2NC	2NO	0220	1	NC	X			
			2	NO				X
			3	NC	X			
			4	NO				X
2NC	1NO-1NC	0211	1	NC	X			
			2	NO				X
			3	NC	X			
			4	NC				X
2NC	2NC	0202	1	NC	X			
			2	NC				X
			3	NC	X			
			4	NC				X

**Contact Block Mounting Position Example**

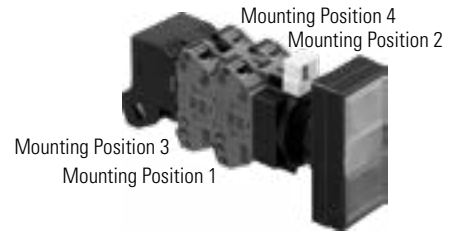

### Contactor Reset Button



#### Reset Buttons (Assembled)

	Plastic Bezel	Metal Bezel
(Blank)	HW1B-M1RS-⊙T	HW4B-M1RS-⊙T
Engraved "R"	HW1B-M1RS-⊙T-ENG-R	HW4B-M1RS-⊙T-ENG-R

-  1. In place of ⊙ specify Button Color Code.
- 2. 130mm (5.1") overall length.
- 3. 16mm flat base for easy alignment

#### ⊙ Button Color Code

Color	Code	Color	Code
Black	B	White	W
Green	G	Yellow	Y
Red	R		
Blue	S		

#### Contactor Reset Button (Sub-assembled)

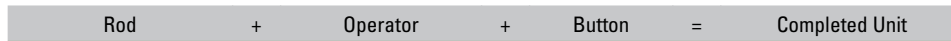

#### Rod

Style	Part Number
	HW9Z-RS-TK2141

#### Button

Style	Part Number
	HW1A-B1-⊙

-  In place of ⊙, specify the Button Color Code from table.

#### Operator

Style	Plastic	Metal
	HW1B-MO	HW4B-MO
		

#### ⊙ Button Color Code

Color	Code	Color	Code
Black	B	White	W
Green	G	Yellow	Y
Red	R		
Blue	S		

Nameplates - HW Series

	HWAM-Black Plastic	HWAQ-Black Plastic	HWAS-Black Plastic	HWAV-Yellow Plastic
Nameplate (blank engraving plate included)	HWAM-OB	HWAQ-OB	HWAS-OB	HWAV-0 HWAV5-0†
Nameplate (engraved)	HWAM-⓪	HWAQ-⓪	HWAS-⓪	HWAV-27* HWAV5-27†
Additional Insert (blank)	HWNP-0	HWNP-0	HWNP Dimensions	
Additional Insert (engraved)	HWNP-⓪	HWNP-⓪		

- 1. In place of ⓪, insert either the standard legend code from table below or custom engraving delimited by " ".
- 2. Standard engravings are available at no charge.
- 3. \* HWAV-27 comes engraved "Emergency Stop" as shown in drawing.
- 4. † HWAV5-27 and HWAV5-0 for 60mm diameter E-Stops (80mm diameter nameplate).

Standard Legend Codes

Pushbuttons				Pushbuttons/Selector Switches				Selector Switches	
Legend	Code	Legend	Code	Legend	Code	Legend	Code	Legend	Code
AUTO	101	OPEN	116	AUTO-MAN	201	REV-FOR	216	AUTO-MAN-OFF	301
CLOSE	102	OUT	117	CLOSE-OPEN	202	RUN-JOG	217	AUTO-OFF-MAN	302
DOWN	103	RAISE	118	DOWN-UP	203	RUN-SAFE	218	CLOSE-OFF-OPEN	303
EMERG.STOP	104	RESET	119	FAST-SLOW	204	SAFE-RUN	219	DOWN-OFF-SLOW	304
FAST	105	REVERSE	120	FOR-REV	205	SLOW-FAST	220	FAST-OFF-SLOW	305
FORWARD	106	RUN	121	HAND-AUTO	206	START-STOP	221	FOR-OFF-REV	306
HAND	107	SLOW	122	HIGH-LOW	207	STOP-START	222	LEFT-OFF-RIGHT	307
HIGH	108	START	123	JOG-RUN	208	UP-DOWN	223	LOWER-OFF-RAISE	308
IN	109	STOP	125	LEFT-RIGHT	209	OI (Int'l OFF ON)	250	OFF-MAN-AUTO	309
INCH	110	TEST	126	LOWER-RAISE	210			OFF-SLOW-FAST	310
JOG	111	UP	127	MAN-AUTO	211			OFF-1-2	311
LOW	112	I (Int'l On)	150	OFF-ON	212			OPEN-OFF-CLOSE	312
LOWER	113	O (Int'l Off)	151	ON-OFF	213			SLOW-OFF-FAST	313
OFF	114	EMO	152	OPEN-CLOSE	214			SUMMER-OFF-WINTER	314
ON	115			RAISE-LOWER	215			UP-OFF-DOWN	315
								1-OFF-2	316
								HAND-OFF-AUTO	317

- 1. To order engraved nameplates, add legend code to nameplate part number.
- 2. Character height based on the number of characters and size of nameplate. Standard character size is 3/16".
- 3. Nameplates with standard legends are the same list price as blank nameplates.
- 4. Nameplates have built-in anti-rotation feature for use with notched panel cut-outs. Additional anti-rotation ring (HW9Z-RL) is not necessary.

### Nameplates Order Form – HW Series

Copy this order form and use it to specify Letter Height, Custom Engravings, Location of Engraving on Nameplate, and Quantity Desired.

To ensure engraving accuracy, fax it to your IDEC representative or Distributor.

Your Company: \_\_\_\_\_  
 Name: \_\_\_\_\_  
 Telephone: \_\_\_\_\_  
 Fax & Email: \_\_\_\_\_

IDEC Rep/Distributor Contact: \_\_\_\_\_  
 PO number (if known): \_\_\_\_\_  
 IDEC Rep/Distributor Phone: \_\_\_\_\_  
 IDEC Rep/Distributor Fax & Email: \_\_\_\_\_

#### HWAM Nameplate

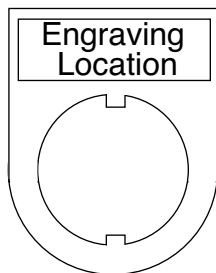

**Step 1.**  
**Choose Letter Size - 7/64" or 1/8".**  
 Check the box for the letter size you want. Then write your lettering in box below the check boxes. Note: 1/8" size letters cannot exceed 9 characters.

7/64" Letter Size  11 characters maximum (for 7/64" size letters)  
 1/8" Letter Size  9 characters maximum (for 7/8" size letters)

**Step 2.**  
**Specify Quantity.**  
 Enter the number of nameplates desired in the box on the right.

Qty

1 2 3 4 5 6 7 8 9 10 11

Sample Letter Sizes  
 7/64" Letters: A B C D  
 1/8" Letters: A B C D

#### HWAQ Nameplate

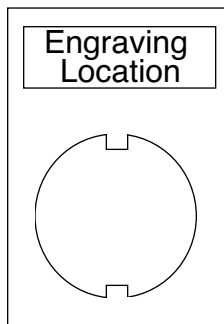

**Step 1.**  
**Choose Letter Size - 7/64" or 1/8".**  
 Check the box for the letter size you want. Then write your lettering in box below the check boxes. Note: 1/8" size letters cannot exceed 9 characters.

7/64" Letter Size  11 characters maximum (for 7/64" size letters)  
 1/8" Letter Size  9 characters maximum (for 1/8" size letters)

**Step 2.**  
**Specify Quantity.**  
 Enter the number of nameplates desired in the box on the right.

Qty

1 2 3 4 5 6 7 8 9 10 11

Sample Letter Sizes  
 7/64" Letters: A B C D  
 1/8" Letters: A B C D

#### HWAS Nameplate

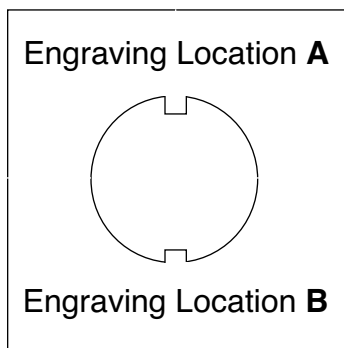

**Step 1.**  
**Choose Letter Size - 3/32" or 1/8".**  
 Check the box for the letter size you want. Then write your lettering in box below the check boxes. Note: 1/8" size letters cannot exceed 14 characters.

3/32" Letter Size  20 characters maximum (for 3/32" size letters)  
 1/8" Letter Size  14 characters maximum (for 1/8" size letters)

**Step 2.**  
**Specify Quantity.**  
 Enter the number of nameplates desired in the box on the right.

Qty

A 1 2 3 4 5 6 7 8 9 10 11 12 13 14 15 16 17 18 19 20

**Step 3.**  
**Specify Location.**  
 Enter the location of engraving (A or B or Both), in box on the right.

Location

B 1 2 3 4 5 6 7 8 9 10 11 12 13 14 15 16 17 18 19 20

Sample Letter Sizes  
 3/32" Letters: A B C D  
 1/8" Letters: A B C D



### Switch Engraving Order Form – HW Series

Copy this order form and use it to specify Letter Height, Maximum Number of Lines and Text to be engraved.

To ensure engraving accuracy, fax it to your IDEC representative or Distributor.

Your Company: \_\_\_\_\_  
 Name: \_\_\_\_\_  
 Address: \_\_\_\_\_  
 PO: \_\_\_\_\_

Telephone: \_\_\_\_\_  
 Fax: \_\_\_\_\_  
 Email: \_\_\_\_\_  
 Part Number to be Engraved: \_\_\_\_\_

Please check one of the boxes below to indicate your choice of engraving options:

ø29mm, ø40mm Mushroom Head

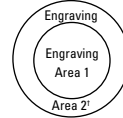

	# of Lines	Letter Height	Max. Characters Per Line
<input type="checkbox"/>	1	5/32	5
<input type="checkbox"/>		1/8	6
<input type="checkbox"/>	2	5/32	5
<input type="checkbox"/>		1/8	6
<input type="checkbox"/>	3	1/8	6
<input type="checkbox"/>	4	3/32	5

	# of Lines	Letter Height	Max. Characters Per Line
<input type="checkbox"/>	1	5/32	5
<input type="checkbox"/>		1/8	5
<input type="checkbox"/>	2	5/32	5
<input type="checkbox"/>		1/8	6
<input type="checkbox"/>	3	1/8	5
<input type="checkbox"/>	4	3/32	5

		# of Lines	Letter Height	Max. Characters Per Line
<input type="checkbox"/>	Engraving Area 1	1	5/32	5
<input type="checkbox"/>			1/8	5
<input type="checkbox"/>	Engraving Area 2	1	5/32	7
<input type="checkbox"/>			1/8	7



- Above mentioned specifications hold true for standard size pushbuttons (round and square).
- \*Engraving Area 2 can be engraved for 40mm mushroom Head non-Illuminated push button only.
- Engraving is done on the button itself for non-Illuminated push buttons and on marking plate for illuminated push buttons and pilot lights.
- Please enter text exactly how you want it engraved, take care to emphasize capital or small letters.

Enter text to be engraved:

**Sample Letter Sizes**

1/8 Letters: **OPEN**

5/32 Letters: **OPEN**

Line 1: \_\_\_\_\_  
 Line 2: \_\_\_\_\_  
 Line 3: \_\_\_\_\_  
 Line 4: \_\_\_\_\_

For IDEC Internal Use Only:  
 Work Order #: \_\_\_\_\_

Accessories

Item	Appearance	Description/Usage	Part Number	
Locking Ring Wrench		Metallic tool used to tighten the plastic locking ring when installing the HW series in a panel	MW9Z-T1	
Lamp/LED Removal Tool		Rubber tool makes lamp/LED removal easier.	OR-55	
Anti-Rotation Ring		Prevents rotation of switches in panel. (included with all assembled switches except pilot lights)	for notched panel cutout (standard)	HW9Z-RL
			for round panel cutout	LW9Z-L
Rubber Mounting Hole Plug		Black rubber plug fills unused 7/8" mounting holes in panel.	OB-31	
Metallic Mounting Hole Plug		For plugging unused 7/8" mounting holes in the panel. Tighten the attached locking ring to a torque of 12 kfg-cm maximum Degree of protection: IP66	LW9Z-BM	
Pushbutton Clear Boot		Used to cover and protect pushbuttons Operating temperature: -50 to +60°C	Flush Pushbuttons	OC-31
			Extended Pushbuttons	OC-32
Padlock Cover		Plastic hinged padlockable cover to protect pushbuttons or selector switches. (Not intended for E-Stops) Degree of protection: IP65	HW9Z-KL1	
Tab Terminal Adapter		Tab #250 (6.35 x 0.8mm): Single tab	TW-FA4	
Mounting Adaptor		Used to mount round HW series (except Jumbo Mushroom, unibody, and square units) into a larger panel cut-out. (includes both pieces)	22 to 30mm	HW9Z-A30
			22 to 25mm	HW9Z-A25
Replacement Safety Lever Lock		Used to prevent contact mounting lever from moving due to heavy vibration or panel maintenance.	HW9Z-LS	
Reset Rod for Contactors Overload		5" rod used with HW1B-M0.	HW9Z-RS-TK2141	
Replacement Operator Washer		Provided with operator. Insert between bezel and locking ring.	HWM-WASHER	
Replacement Locking Ring		Plastic locking nut comes with all HW operators & assemblies.	Standard (plastic)	HW9Z-LN
			Optional (metal)	HW9Z-LNM
Switch Cover (Square)		Used only with round or square flush pushbuttons.	HW9Z-K1 (spring return) HW9Z-K11 (maintained cover)	
Replacement Keys		Pair of Keys (#231)	HW9Z-SKP	
Replacement Lens		HW Illuminated Unibody Replacement Lens	HWLV-LENSR	

Switches & Pilot Devices

Signaling Lights

Relays & Sockets

Timers

Contactors

Terminal Blocks







Circuit Breakers

Switches & Pilot Devices



Signaling Lights

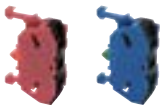
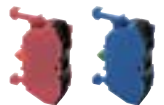

Relays & Sockets

Timers

Item	Appearance	Description/Usage	Part Number	
Replacement Jumbo Dome Lens		Polycarbonate Replacement Lens (If using yellow lens, use white LED.)	HW1A-P5Ⓞ Ⓞ = (A, G, R, S, W, Y)	
Replacement Jumbo LED Diffusing Lens			HW9Z-PP5C	
Replacement LED Lamps for HW Jumbo Dome		Replacement LED Lamp - applicable for jumbo pilot lights only	LSTD8-2Ⓞ Ⓞ = (A, G, R, S, W)	
Rubber Cover for Dual Pushbuttons		Clear Silicon rubber cover	HW9Z-D7D	
Barrier for Dual Pushbuttons		Plastic barrier. Used when mounting the HW7 units on 30mm horizontal centers, to prevent possible interconnections between adjoining terminals.	HW-VU1	
EMO Sticker		Emergency stop nameplate sticker	HW9Z-EMO-NP-TK2120	
Contact Blocks (with side entry)		These contacts are applicable for wires terminated by ring, fork, terminals, <b>not recommended for bare wire connections.</b>	<b>1NC</b>	<b>1NO</b>
			HW-U01 HW-U01-MAU HW-U01R HW-U01R-MAU (with side entry)	HW-U10 HW-U10-MAU HW-U10R HW-U10R-MAU (with side entry)
Contact Blocks (without side entry)		These contacts are applicable for wires terminated by ring, fork, or ferule terminals, and <b>also bare wire connections.</b>	HW-U01-F HW-U01-MAU-F HW-U01R-F HW-U01R-MAU-F (no side entry)	HW-U10-F HW-U10-MAU-F HW-U10R-F HW-U10R-MAU-F (no side entry)

**E-Stop Shrouds**

Style	Part Numbers	E-Stop Types	Applicable Standards
	HW9Z-KG1	40mm Mushroom Head	SEMI S2-0703, 12.5.1 Compliant
	HW9Z-KG2	40mm Mushroom Head	SEMI S2-0703, 12.5.1 & SEMATECH Compliant

Style	Part Numbers	E-Stop Types	Applicable Standards
	HW9Z-KG3	40mm Mushroom Head	SEMI S2 Compliant (Approved by TUV) ISO 13850
	HW9Z-KG4	40mm Mushroom Head	SEMI S2 Compliant (Approved by TUV) & SEMATECH ISO 13850

Contactors

Terminal Blocks

Circuit Breakers



Square Extended (HW2B-M2, -A2)

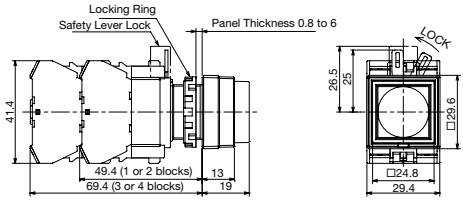

Contact Block (Bottom View)

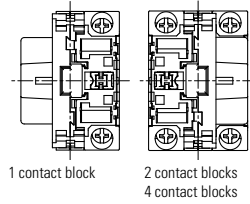

Terminal Wiring

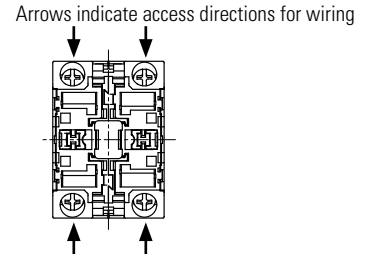

Operators

Dimensions (mm)

Flush (Round & Square)

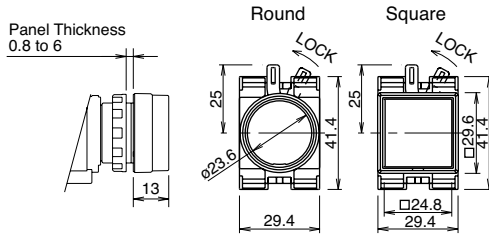

Extended

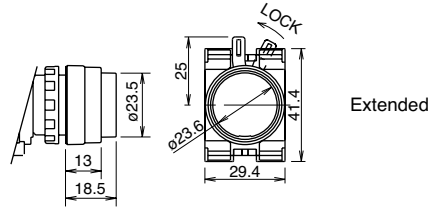

Extended with Full Shroud

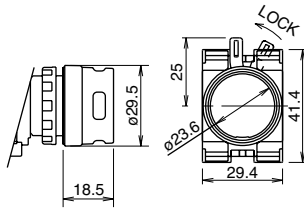

ø40mm Mushroom

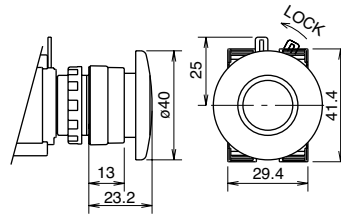

Emergency Stop Pushbuttons

Dimensions (mm)

ø29mm Head Pushlock Turn Reset (HW1B-V3)

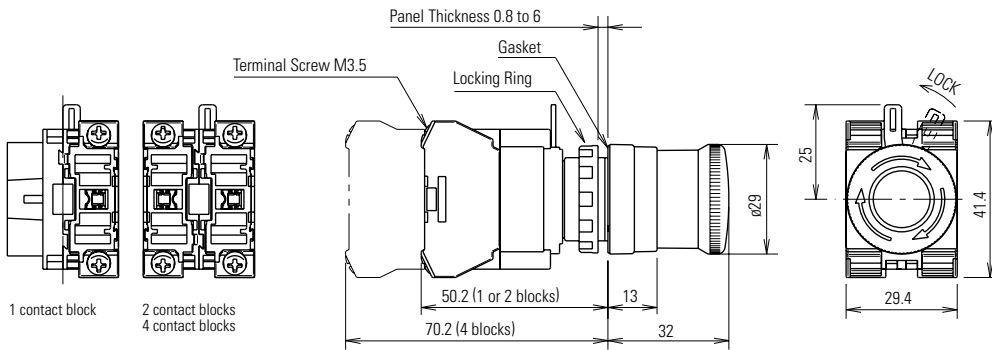

ø40mm Head Pushlock Turn Reset (HW1B-V4)

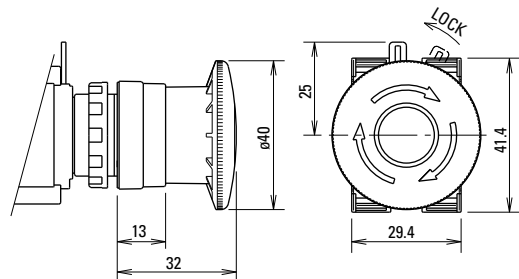

ø40mm Head EMO Pushlock Turn Reset (HW1B-V4)

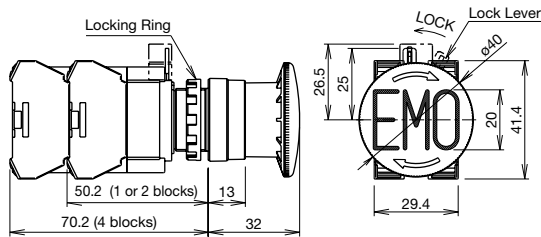

ø40mm Head Pushlock Key Reset (HW1B-X4)

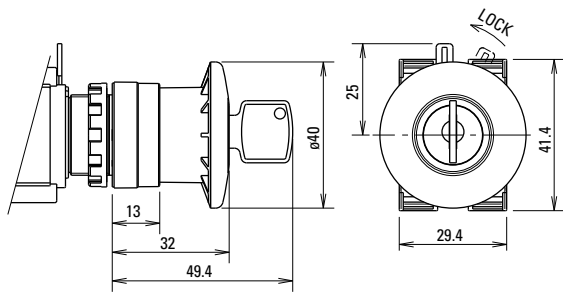

ø60mm Head Pushlock Turn Reset (HW1B-V5)

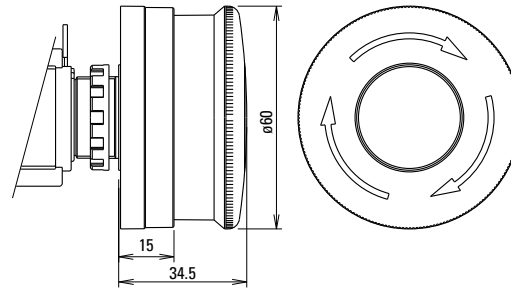

ø40mm Head Push-Pull (HW1B-Y2)

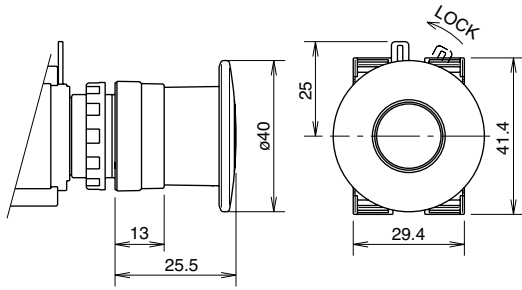

ø40mm Head Unibody Pushlock Turn Reset (HW1B-BV4)

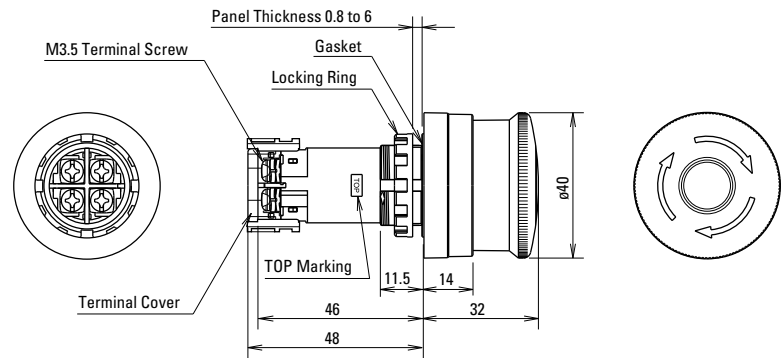

Illuminated E-Stop Pushbuttons (HW1E-LV4)

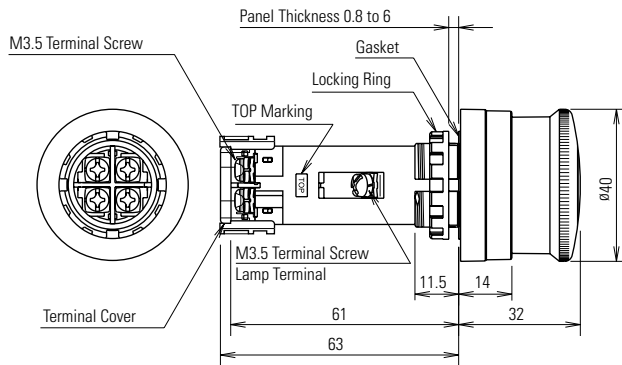

Mounting Hole

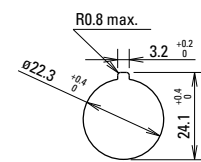

The minimum mounting centers shown below are applicable to E-Stop switches with one layer of contact blocks (two contact blocks). When two layers of contact blocks are mounted, determine the minimum mounting centers for ease of wiring.

Unit	Vertical Spacing	Horizontal Spacing
HW1B-V3 HW1B-V4 HW1B-X4 HW1B-Y2	50 mm	50 mm
HW1B-V5	60 mm	60 mm

Terminal Arrangement (Bottom View)

HW1E-BV4

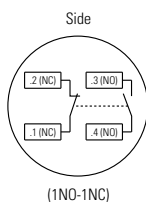

HW1E-LV4

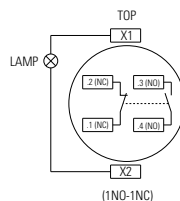

**Emergency Stop Stations**

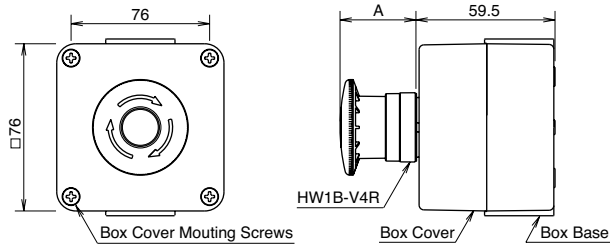

Operator	Dimension A (mm)
Pushlock Turn Reset	32
Pushlock Key Reset	32 (Key inserted: 49.4)
Push Pull	25.5

**Mounting Hole Layout**

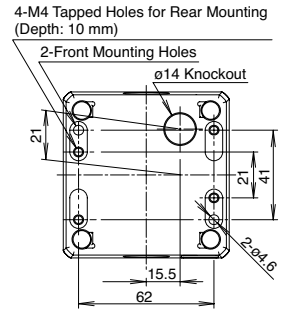

Dimensions (mm)

**Pilot Lights**

**Round Flush Terminal screws: M3.5, integrated terminal cover**

6, 12, 24V AC/DC, Without LED lamp

100/110V AC, 200/220V AC (240V AC maximum)

110V DC, 380V AC minimum

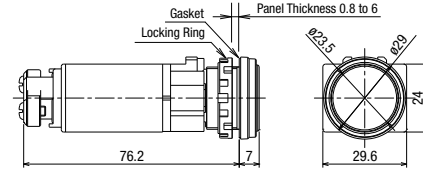
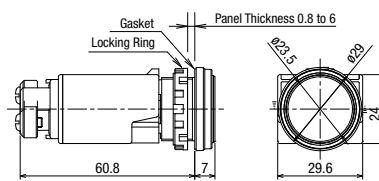
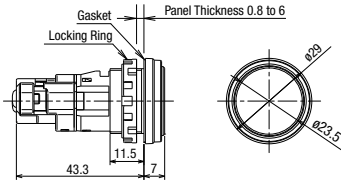

Dimensions (mm)

**Extended Terminal screws: M3.5, integrated terminal cover**

6, 12, 24V AC/DC, Without LED lamp

100/110V AC, 200/220V AC (240V AC maximum)

110V DC, 380V AC minimum

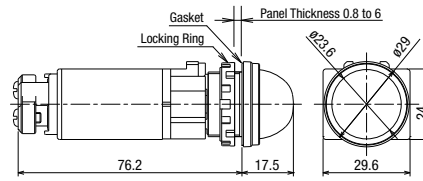
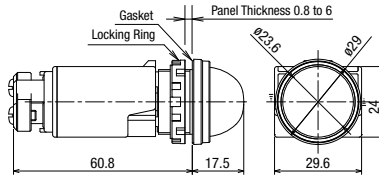
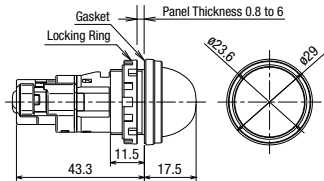

**Square Flush Terminal screws: M3.5, integrated terminal cover**

6, 12, 24V AC/DC, Without LED lamp

100/110V AC, 200/220V AC (240V AC maximum)

110V DC, 380V AC minimum

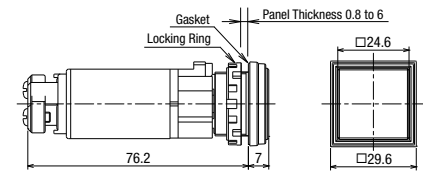
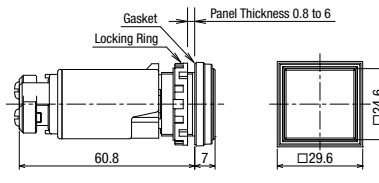
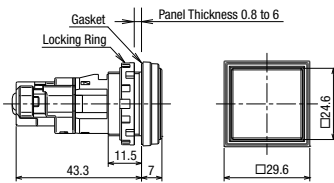

**Jumbo Dome Pilot Light Terminal screws: M3.5, integrated terminal cover**

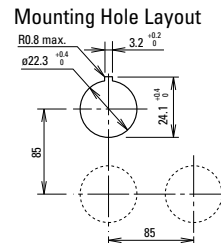
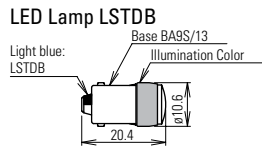
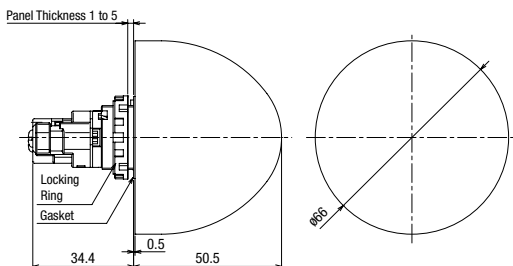

**Mounting Hole Layout**  
Close mounting on 30mm centers  
Degree of protection: IP65

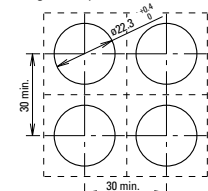

When mounting transformer or DC-DC converter type units on 30mm centers vertically and horizontally, keep the ambient temperature below 40°C.

### Illuminated Pushbuttons

Full Voltage Models

#### 1 Contact Block

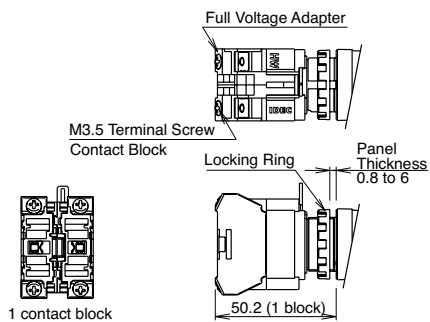

#### 2 Contact Blocks

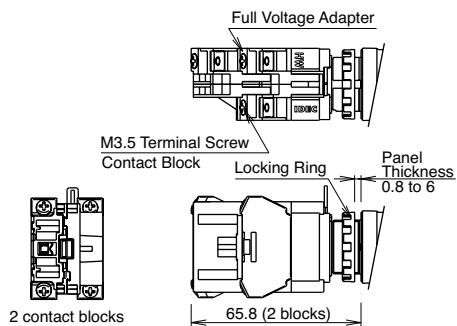

#### 3 Contact Blocks

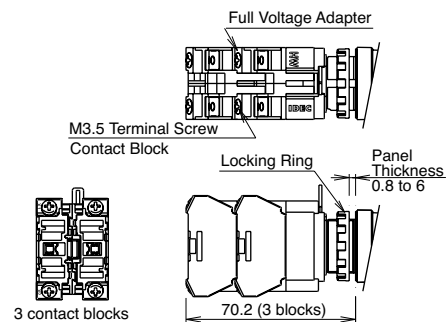

### Illuminated Pushbuttons con't

#### 4 Contact Blocks

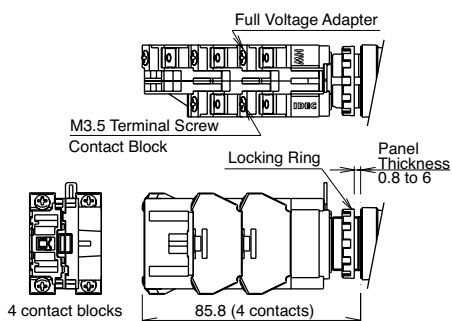

#### Terminal Wiring

Arrows indicate access directions for wiring.

#### Contact Block

##### Full Voltage Adaptor

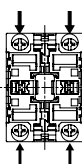

##### Transformer

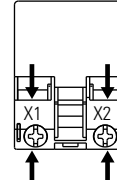

#### Transformer Models

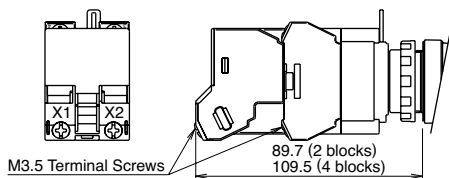

#### DC-DC Converter Models

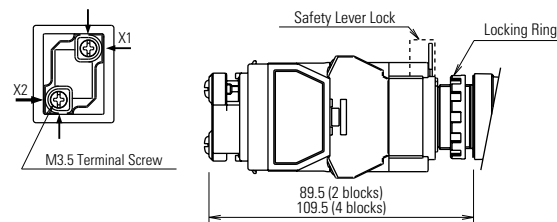

Dimensions (mm)



**Non-Illuminated Selector & Key Switches**

**Knob Operator**

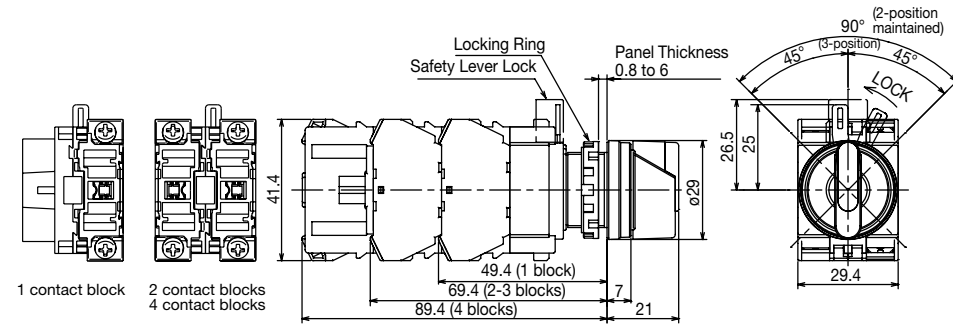

1 contact block  
2 contact blocks  
4 contact blocks

Dimensions (mm)

**Terminal Wiring**

Arrows indicate access directions for wiring.

**Contact Block Full Voltage Adaptor**

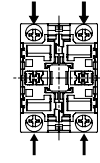

**Key Operator**

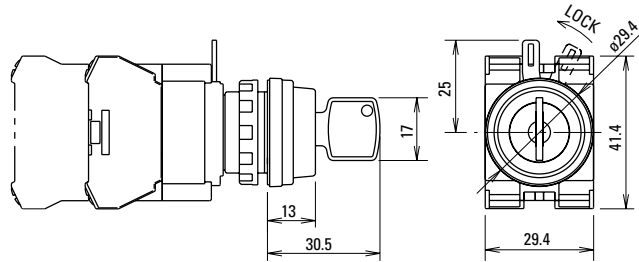

**Transformer**

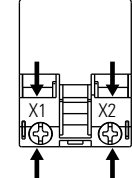

**Illuminated Selector Switches**

**Full Voltage Model**

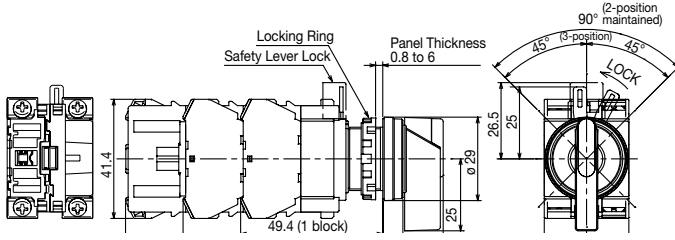

**Transformer Model**

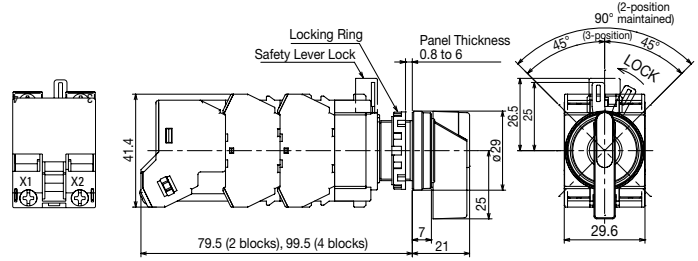

### Dual Pushbutton

Without Pilot Light

Dimensions (mm)

Mounting Hole Layout

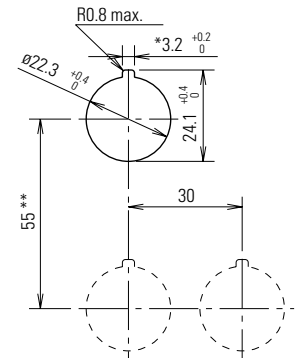

-The 3.2 mm recess is for preventing rotation and is not necessary when a nameplate or anti-rotation ring is not used.  
 -When using the safety lever lock, determine the vertical spacing in consideration of convenience for installing and removing the safety lever lock.  
 -Recommended vertical spacing: 100 mm  
 -The minimum mounting centers are applicable to switches with one layer of contact blocks (two contact blocks). When two layers of contact blocks are mounted, determine the minimum mounting centers for ease of wiring.

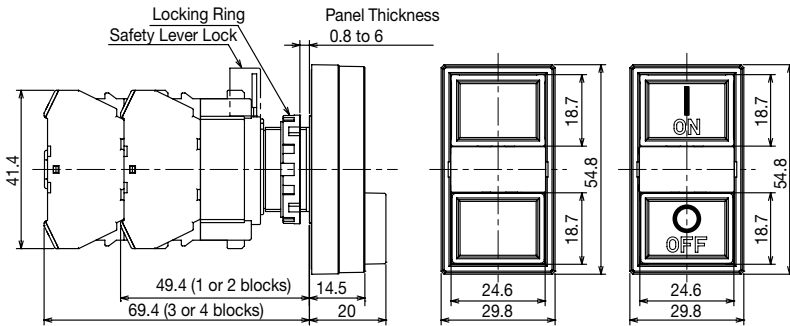
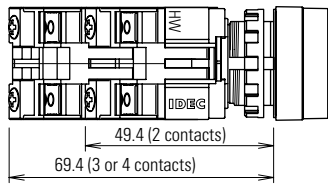

With Pilot Light

Full Voltage

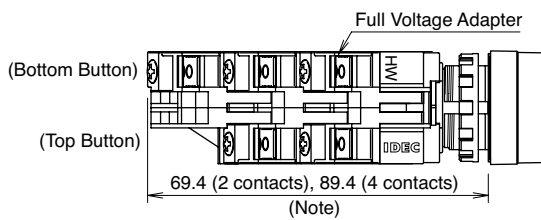

The depth of a 3-contact model depends on the combination of contact blocks at top and bottom pushbuttons.

Top Button	1 contact block	2 contact blocks
Bottom Button	2 contact blocks	1 contact block
Depth	89.4 mm	69.4 mm

Transformer (240V minimum)

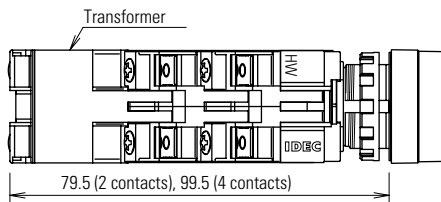

Transformer (480V)

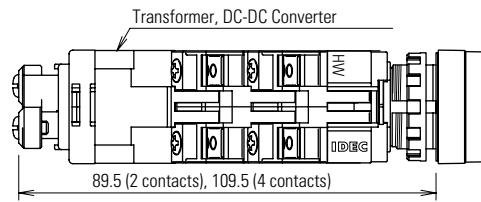

### Monolever

Dimensions

Standard Lever

Interlocking Lever

All dimensions in mm.

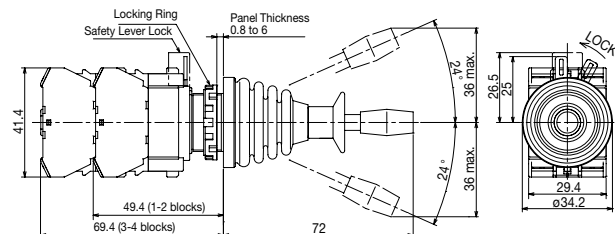
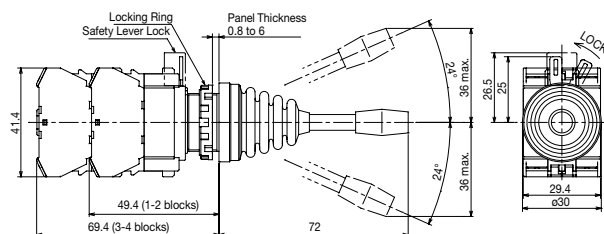

Terminal Screws M3.5    Integrated Terminal Cover

Accessory Dimensions

**LW9Z-BM**  
Metallic Mounting Hole Plug

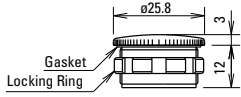

**OB-31**  
Rubber Mounting Hole Plug

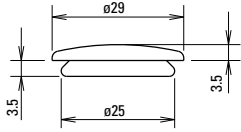

**HW9Z-RL**  
Anti-Rotation Ring

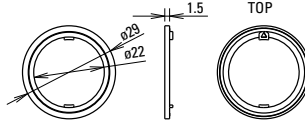

**OR-55**  
Lamp/LED Removal Tool

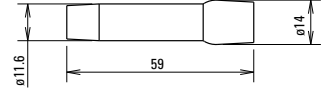

**HW9Z-D7D**  
Dual Pushbutton Rubber Cover

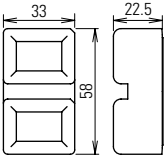

**HW-VU1**  
Dual Pushbutton Barrier

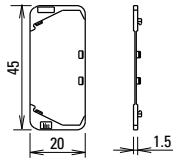

**MW9Z-T1**  
Locking Ring Wrench

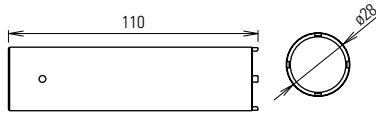

**HW-VL1**  
Barrier

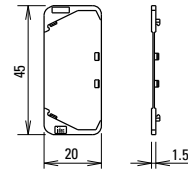

**HW9Z-KL1**  
Padlock Cover

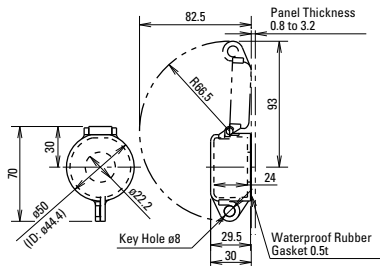

**HWLS-TK1971**  
Safety Lever Lock

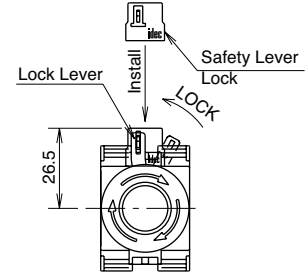
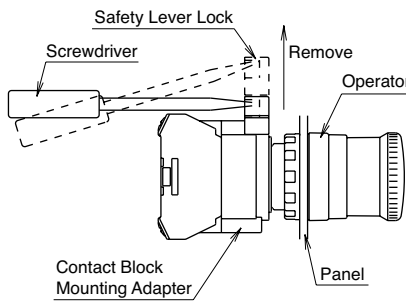

**HW9Z-KG1**

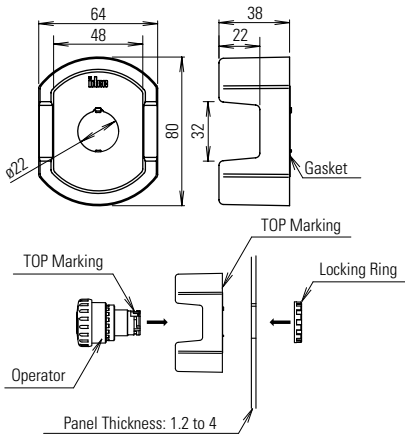

**HW9Z-KG2**

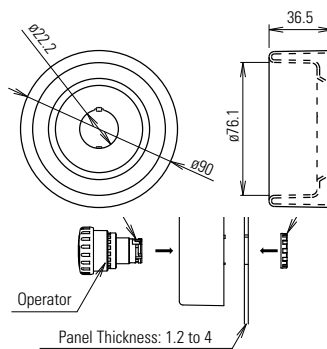

**HW9Z-KG3**

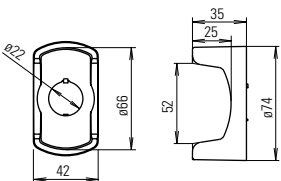

**HW9Z-KG4**

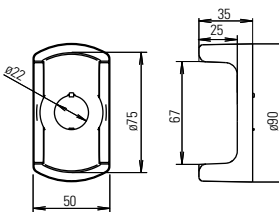

**LSTD**

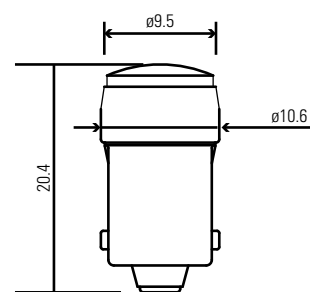

Specification Charts

INDUCTIVE

DC Voltages

Voltage V	24	48	110
Current A	4	2	1.1

AC Voltages

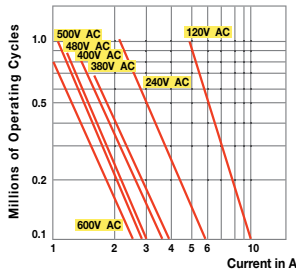

RESISTIVE

DC Voltages

Voltage V	24	48	110
Current A	8	4	2.2

AC Voltages

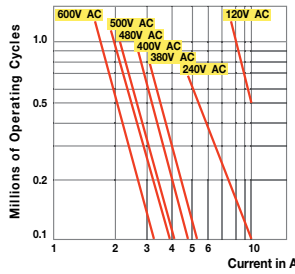

Conforming to IEC 947-5-1 Appendix C.  
Utilization categories AC-15 and DC-13.  
Operation rate: 1,800 op. hour  
Load factor:  
Inductive 0.4 ± 0.05  
Resistive 0.9 ± 0.05

2 Position Selector Switches

	Contact	Mounting Position	Operator Position	
			Left	Right
HW1S-2T HW1K-2* HW1F-2	HW-U10-F (NO)	L	0	X
		R	0	X
	HW-U01-F (NC)	L	X	0
		R	X	0
	HW-U10R-F (NO-EM)	L	0	X
		R	0	X
	HW-U01R-F (NC-LB)	L	X	0
		R	X	0

3 Position Selector Switches con't

	Contact	Mounting Position	Operator Position		
			Left	Center	Right
HW1S-3JT HW1K-3J*	HW-U10-F (NO)	L	X	0	0
		R	0	0	X
	HW-U01-F (NC)	L	0	X	0
		R	0	X	0
	HW-U10R-F (NO-EM)	L	X	0	X
		R	X	0	X
	HW-U01R-F (NC-LB)	L	0	X	X
		R	X	X	0

3 Position Selector Switches

	Contact	Mounting Position	Operator Position		
			Left	Center	Right
HW1S-3T HW1K-3* HW1F-3	HW-U10-F (NO)	L	X	0	0
		R	0	0	X
	HW-U01-F (NC)	L	0	X	X
		R	X	X	0
	HW-U10R-F (NO-EM)	L	X	0	0
		R	0	0	X
	HW-U01R-F (NC-LB)	L	0	X	X
		R	X	X	0

4 Position Selector Switches

	Contact	Mounting Position	Operator Position			
			1	2	3	4
HW1S-4T	HW-U10-F (NO)	L	X	0	0	0
		R	0	0	0	X
	HW-U01-F (NC)	L	0	0	X	0
		R	0	X	0	0
	HW-U10R-F (NO-EM)	L	X	X	0	X
		R	X	0	X	X
	HW-U01R-F (NC-LB)	L	0	X	X	X
		R	X	X	X	0

5 Position Selector Switches

	Contact	Mounting Position	Operator Position				
			1	2	3	4	5
HW1S-5T	HW-U10-F (NO)	L	X	0	0	0	0
		R	0	0	0	0	X
	HW-U01-F (NC)	L	0	0	0	X	0
		R	0	X	0	0	0
	HW-U10R-F (NO-EM)	L	X	X	X	0	X
		R	X	0	X	X	X
	HW-U01R-F (NC-LB)	L	0	X	X	X	X
		R	X	X	X	X	0

1. Mounting position indicates which side of operator each contact should be mounted (as viewed from the front of the panel).
2. \*For key removable code see page 663.

3. HW1S-3T is identified by white plungers on the operator.
4. HW1S-3ST is identified by red plungers on the operator.
5. HW1S-3JT is identified by black plungers on the operator.

### HW Safety Precautions

Turn off power to HW series control units before starting installation, removal, wiring, maintenance, and inspection of the products. Failure to turn power off may cause electrical shocks or fire hazard.

To avoid the possibility of burning yourself, use the lamp holder tool when replacing lamps.

For wiring, use wires of a proper size to meet voltage and current requirements.

### HW General Instructions

#### Panel Mounting

Remove the contact block assembly from the operator (for transformer type pilot lights, remove the transformer from the illumination unit). Remove the locking ring from the operator. Insert the operator into the panel cut-out from the front, tighten the locking ring from the back, then install the contact block assembly to the operator.

#### Removing and Installing the Contact Block Assembly

1. To remove the operator from the contact block, turn the locking lever in the direction of the arrow shown below. The operator can now be removed.
2. To reinstall, place the TOP markings on the operator and the contact block mounting adapter in the same direction, and insert the operator into the contact block mounting adapter. Then turn the locking lever in the opposite direction.

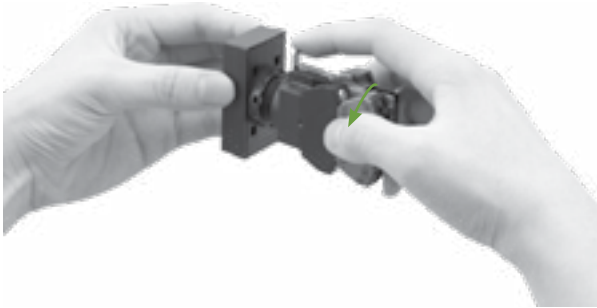

#### Safety Lever Lock

IDEC strongly recommends using the safety lever lock (HW9Z-LS, yellow) to prevent heavy vibration or maintenance personnel from unlocking the contact assembly.

1. HW series can be mounted vertically with a minimum spacing of 55 mm but spacing should be determined to ensure easy operation (recommended minimum spacing: 100 mm).
2. Mount the control unit onto the panel, lock the lever, and push in the safety lever lock to install.
3. When the spacing is narrower than the recommended value, with the lever unlocked, mount the safety lever lock and insert the contact unit to the operator. Then, lock the lever and strongly push in the safety lever lock to install.
4. To remove the safety lever lock, insert a flat screwdriver into the safety lever and push upwards.

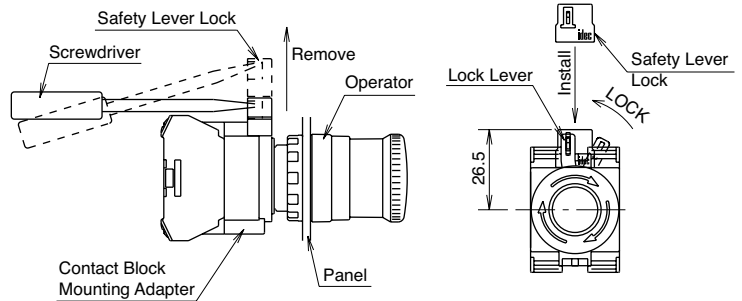

#### Notes for Panel Mounting

1. When mounting the operator onto a panel, use the optional locking ring wrench (MW9Z-T1) to tighten the locking ring. Tightening torque must not exceed 2.0 N·m. Do not use pliers. Excessive tightening will damage the locking ring.
2. For the contact blocks and transformers housing LED lamps, make sure not to press the lamps too hard, otherwise the lamp socket may be damaged.

### Dual Pushbutton Instructions

#### Replacement of Lens

##### Removing

Remove the lens by inserting a screwdriver into the recess of the lens through the bezel.

##### Installing

Install the lens in the recess between the buttons by pressing against the bezel.

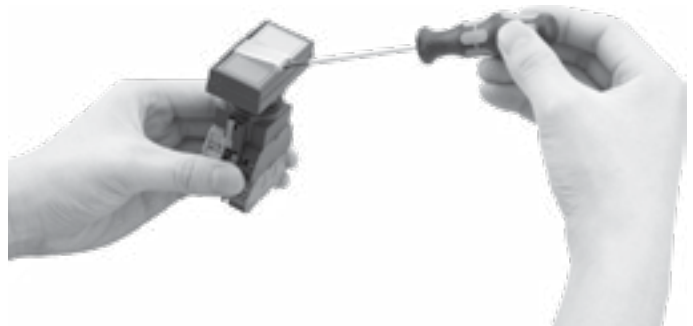

### Dual Pushbuttons Instructions continued

#### Replacement of Lamps

LED lamps can be replaced by using the lamp holder tool (OR-55) from the front of the panel, or by removing the contact block assembly from the operator unit.

#### Removing the Lamps from the Front of the Panel

##### Removal

1. To remove, slip the lamp holder tool onto the lamp head lightly. Then push slightly, and turn the lamp holder tool counterclockwise.



##### Installation

1. To install, insert the lamp head into the lamp holder tool, and hold the lamp as shown in the figure below.
2. Place the pins on the lamp base to the grooves in the lamp socket. Insert the lamp and turn it clockwise.

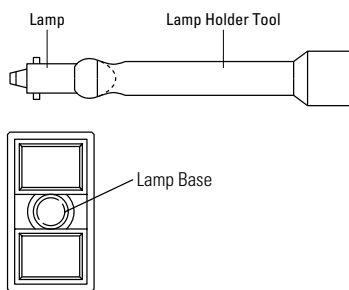

#### About Dual Pushbutton Switches

The dual pushbuttons cannot be removed or replaced!  
Do not attempt to remove using a flat screwdriver or pincers, otherwise the dual pushbuttons may be damaged.

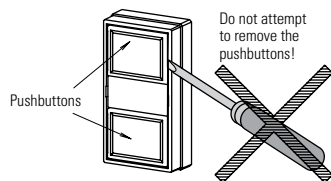

#### Narrow Mounting

When mounting the units closely in a horizontal row on 30mm centers, use optional barriers to prevent interconnection between adjoining terminals. The barriers can be attached simply by pressing them onto the sides of contact blocks.



When mounting transformer type illuminated units closely in a horizontal row on 30mm centers, insert solid wires or stranded wires into inside of the terminal screw on the transformer (see figure on the right) to prevent short circuit between adjoining terminals.

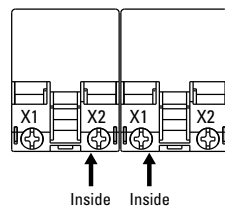

#### Installation of LED Illuminated Units

When using full voltage type LED illuminated units, provide protection against electrical noise, if necessary.

#### Applicable Wiring

The applicable wire size is 2 mm<sup>2</sup> maximum. (solid wire ø1.6mm<sup>2</sup> maximum) One or two wires can be connected.

#### Applicable Crimping Terminal

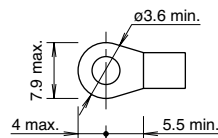

Be sure to use an insulation tube or cover on the crimping part of the crimping terminal to prevent electrical shocks.

#### Solid Wire

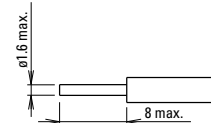

Note: When connecting wires to contact blocks or transformers in the direction shown below, keep the insulation stripping length 6.6 mm at the maximum.

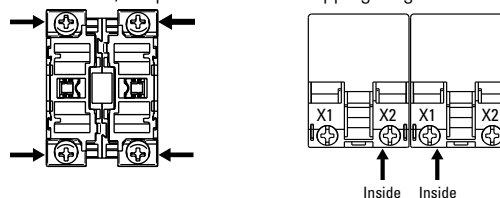

#### Installing the Rubber Boot

When using the HW7D pushbuttons in places where the pushbuttons are subjected to water splash or an excessive amount of dust, make sure to use the HW9Z-D7D rubber boot (IP65) which is ordered separately.

#### Notes for Installing the Rubber Boot

Remove the gasket from the operator, and install the rubber boot on the operator. Pull out the seals of the rubber boot and place them around the operator sleeve as shown. Make sure that the seals are not twisted or tucked inside and that the gasket does not remain, otherwise the normal waterproof and dustproof characteristics are not ensured.

1. Remove the gasket.
2. Install the rubber boot on the pushbuttons.
3. Rubber boot is installed.

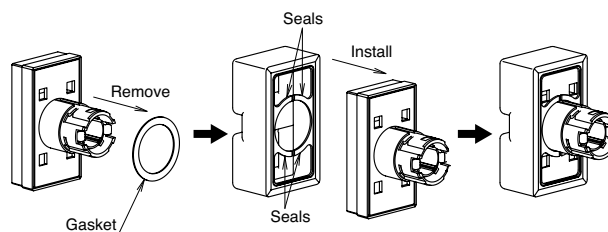

## X-ON Electronics

Largest Supplier of Electrical and Electronic Components

*Click to view similar products for [Industrial Panel Mount Indicators / Switch Indicators](#) category:*

*Click to view products by [Idec](#) manufacturer:*

Other Similar products are found below :

[01-121.022](#) [LW1A-P1-W](#) [LW1B-A0L](#) [01-952.0](#) [01-152.025](#) [D38999/20FJ29PB L/C](#) [704-6012](#) [704-6020](#) [704-6023](#) [704-6026](#) [73.362.4028.0](#)  
[EUS-704.000.7](#) [750-1520](#) [9001OA120](#) [99-450.837](#) [99-455.837](#) [99-486.837](#) [99-901.9](#) [99-902.9](#) [99-908.0](#) [99-909.4](#) [99-909.5](#) [A0244J1](#)  
[A3DT-500Y](#) [AL6M-P7P-A](#) [AOLQW-2B0600](#) [AP1M255-A](#) [APD106LN-A](#) [APD106LN-G](#) [APN1126-G](#) [APS122DN-W](#) [ATN2100](#)  
[AYLW4L-A](#) [18-237.035](#) [C0180AANAHA](#) [HW1A-L1-GD](#) [HW1A-P2-GL](#) [HW1F-3G](#) [HW1R-2DF20-R](#) [HW1X-BM411-R](#) [HW2A-L1-GL](#)  
[HW2A-P1-GD](#) [HW4S-31L](#) [HWAZ1N-OB](#) [PA2200/1](#) [PA2SHIELD](#) [21-931.0](#) [21-931.2](#) [96-923.5](#) [1625006](#)