



Think Automation and beyond...



IDEC LB Series

Flush Mount & 16mm Miniature Switches and Pilot Lights

Design & Function

Flush mount switches provide a sleek and stylish appearance. 16mm miniature switches and pilot lights with a depth of only 27.9mm accommodate smaller machines and panels.

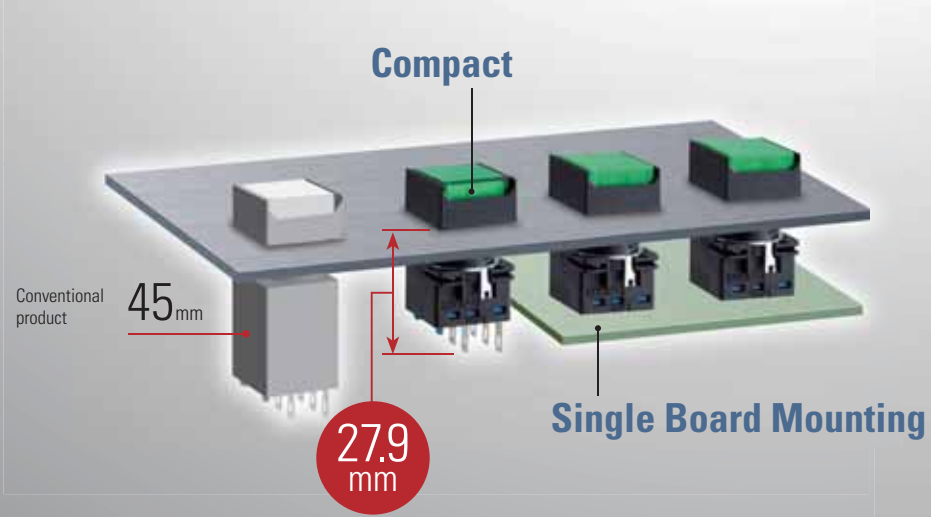

Compact

Short body

The LB series is the shortest in the industry, only 27.9mm deep behind the panel. Reduces the size of machines and control panels.

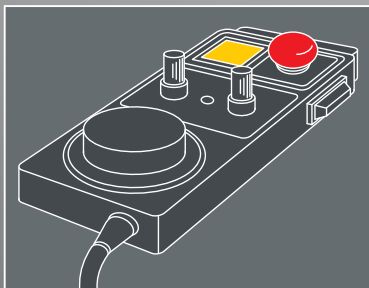

Simple

Single board mounting & removable contact blocks

Removable contacts enable easy wiring. Single board mounting reduces installation time and prevents incorrect wiring.





Watertight

Degree of protection: IP65

Perfect for environments where water is sprayed under pressure such as food and beverage processing.

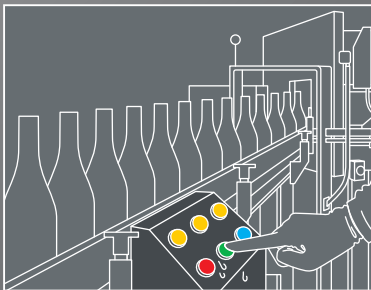

Flush Mount

Stylish

Flush bezels project only 2mm from the panel surface. The slim and stylish panel design enhances the appearance of any application.

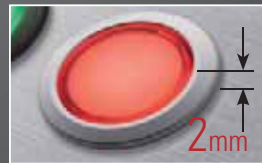

Flush Mount Switches & Pilot Lights



- Projects only 2mm from the panel surface.
- Removable contact blocks ideal for single board mounting.
- Protection degree: IP65 (IEC 60529)

Illuminated Pushbuttons Pg. 7
Illuminated Pushbuttons with Switchguard available



Pushbuttons Pg. 11
Pushbuttons with Switchguard available

Lens with marking plate can also be used as a pushbutton.



Pilot Lights Pg. 9



Dome Pilot Lights Pg. 9



Selector Switches
Non-illuminated Pg. 13
Illuminated Pg. 15

2-position and 3-position selector switches. Maintained and spring return available.



Key Selectors Pg. 17

Wave key
Seven different keys available.



Lever Switches Pg. 20



Buzzers Pg. 21



Illuminated Pushbutton Color Options



Pushbutton Color Options



16mm Miniature Switches & Pilot lights

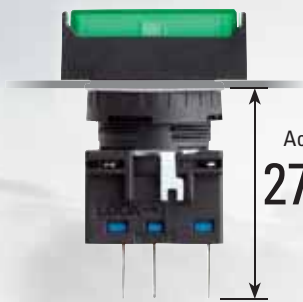

Short

Actual Size
27.9mm

- Panel depth of only 27.9mm.
- Removable contact blocks are ideal for single board mounting.
- Protection degree: IP65 (IEC 60529)

Illuminated Pushbuttons Pg. 7



Round



Square



Rectangular



Pushbuttons Pg. 11

Lens with marking plate can also be used as a pushbutton.



Pilot Lights Pg. 9



Dome Pilot Lights Pg. 9



Selector Switches Non-illuminated Pg. 13 Illuminated Pg. 15

2-position and 3-position selector switches. Maintained and spring return available.



Illuminated shown



Knob shown



Lever shown

Key Selectors Pg. 17

Wave key
Seven different keys available.



Lever Switches Pg. 20



Buzzers Pg. 21



IP54



Terminal side



IP40



Terminal side



Bezel Options



Metallic Black

Flush Mount & 16mm Miniature Switches & Pilot Lights

Flush bezel projects only 2mm from front of panel. Standard bezel has a panel depth of only 27.9mm! Removable contact blocks are ideal for single board mounting.

- Pushbuttons, lever switches, selector switches, and key selector switches with up to 3PDT contacts.
- Key selectors with keys that are difficult to duplicate. Seven different key numbers to choose from.
- Pilot lights with flat or dome lenses.
- Buzzers with 80dB steady sound.
- Black or metallic flush bezels available.
- Bright and clear LED illuminated face.
- Choice of either gold-clad or silver contacts.
- Degree of protection: IP65 (from the front of the panel).



Applicable Standards	Mark	File No. or Organization
UL508		UL Recognition No.E55996
CSA 22.2 No.14		CSA File No. LR 21451
EN60947-5-1		TÜV Rheinland
		EU Low Voltage Directive
GB14048.5		

Specifications

Operating Temperature	-25 to +60°C (no freezing) Illuminated units: -25 to +55°C	
Storage Temperature	-30 to +80°C (no freezing)	
Operating Humidity	45 to 85% RH (no condensation)	
Contact Resistance	50 mW maximum (initial value)	
Insulation Resistance	100 MW minimum (500V DC megger)	
Dielectric Strength	Switch	Between live part and ground: 2,000V AC, 1 min. Between terminals of different poles: 2,000V AC, 1 min. Between terminals of the same poles: 1,000V AC, 1 min.
	Illumination	Between live part and ground: 2,000V AC, 1 min.
Vibration Resistance	Operating extremes/Damage limits: 5 to 55 Hz, amplitude 0.5mm	
Shock Resistance	Operating extremes: 100 m/s ² Damage limits: 1,000 m/s ²	
Mechanical Life (minimum operations)	Momentary: 2,000,000	
	Maintained: 250,000	
	Selector switches: 250,000 Key selector switches: 250,000	
Electrical Life (minimum operations)	Momentary: 50,000 / 100,000 ^{Note 1}	
	Maintained: 50,000 / 100,000 ^{Note 2}	
	Selector switches: 50,000 / 100,000 ^{Note 2} Key selector switches: 50,000 / 100,000 ^{Note 2}	
Degree of Protection	IP65 (IEC 60529)	
Terminal Style	Solder/tab terminal #110 PC board terminal	
Bezel	Black plastic or metallic	
Weight (approx.)	11g (lever switch)	
	13g (pilot light, pushbutton)	
	14g (illuminated pushbutton, pushbutton with guard, buzzer)	
	15g (selector switch, illuminated pushbutton with guard) 27g (key selector switch)	

1. Switching frequency 1,800 operations/h.
2. Switching frequency 1,200 operations/h.

Contact Ratings

Gold Contact (switch base color: blue)

Rated Insulation Voltage	250V	
Rated Thermal Current	3A	
Rated Operating Voltage	30V DC	125V AC
Rated Operating Current (resistive load)	0.1A	0.1A
Contact Material	Gold-clad silver	

Minimum applicable load (reference value): 5V AC/DC, 1 mA

Silver Contact (switch base color: gray)

Rated Insulation Voltage	250V					
Rated Operating Voltage	30V	125V	250V			
Rated Operating Current	Electrical Life 50,000 Operations	AC 50/60Hz	Resistive load	—	5A	5A
			Inductive load	—	3A	1.5A
		DC	Resistive load	5A	1.1A	—
	Inductive load		2.5A	0.55A	—	
	Electrical Life 100,000 Operations	AC 50/60Hz	Resistive load	—	5A	3A
			Inductive load	—	3A	1.5A
DC		Resistive load	3A	0.6A	—	
Inductive load	1A	0.22A	—			
Rated Thermal Current	5A					
Contact Material	Silver					

AC inductive load: PF=0.6 to 0.7 DC inductive load: L/R=7 ms max.

LED Ratings

Rated Voltage	5V DC	12V AC/DC	24V AC/DC
Voltage Range	5V DC±5%	12V AC/DC±10%	24V AC/DC ±10%
LED Part No.	LB9Z-LED5 [Ⓢ]	LB9Z-LED1 [Ⓢ]	LB9Z-LED2 [Ⓢ]
Rated Current	A, R: 22 mA G, PW, S: 16 mA		
Voltage Rating	Marked on the side of the LED unit		
LED Life (reference value)	Approx. 30,000 hours (until the brightness reduces to 50% of the initial value)		
Internal Circuit	A, PW, R		A, PW, R
	G, S		G, S
	LED Chip Protection Diode Zener Diode Resistor Varistor		

1. For [Ⓢ] (color code): A (amber), G (green), PW (white), R (red), S (blue)
2. Use the white LED for yellow illumination.
3. LED lamp contains a current-limiting resistor.

Illuminated Pushbuttons (Assembled)

Style	Operation	Operating Voltage	Contact	Standard Bezel		Flush Bezel		Color Code
				Solder/Tab Terminal (silver contacts)	PC Board Terminal (gold contacts)	Solder/Tab Terminal (silver contacts)	PC Board Terminal (gold contacts)	
Standard Bezel (black)   	Momentary	5V DC	SPDT	LB⓪L-M1T51⓪	LB⓪L-M1T11V⓪	LB⓪⓪L-M1T51⓪	LB⓪⓪L-M1T11V⓪	Specify the color code in place of ⓪ in the Part Number: A: amber G: green R: red S: blue PW: white Y: yellow
			DPDT	LB⓪L-M1T61⓪	LB⓪L-M1T21V⓪	LB⓪⓪L-M1T61⓪	LB⓪⓪L-M1T21V⓪	
		12V AC/DC	SPDT	LB⓪L-M1T53⓪	LB⓪L-M1T13V⓪	LB⓪⓪L-M1T53⓪	LB⓪⓪L-M1T13V⓪	
			DPDT	LB⓪L-M1T63⓪	LB⓪L-M1T23V⓪	LB⓪⓪L-M1T63⓪	LB⓪⓪L-M1T23V⓪	
		24V AC/DC	SPDT	LB⓪L-M1T54⓪	LB⓪L-M1T14V⓪	LB⓪⓪L-M1T54⓪	LB⓪⓪L-M1T14V⓪	
			DPDT	LB⓪L-M1T64⓪	LB⓪L-M1T24V⓪	LB⓪⓪L-M1T64⓪	LB⓪⓪L-M1T24V⓪	
Flush Bezel (metallic or black)   	Maintained	5V DC	SPDT	LB⓪L-A1T51⓪	LB⓪L-A1T11V⓪	LB⓪⓪L-A1T51⓪	LB⓪⓪L-A1T11V⓪	
			DPDT	LB⓪L-A1T61⓪	LB⓪L-A1T21V⓪	LB⓪⓪L-A1T61⓪	LB⓪⓪L-A1T21V⓪	
		12V AC/DC	SPDT	LB⓪L-A1T53⓪	LB⓪L-A1T13V⓪	LB⓪⓪L-A1T53⓪	LB⓪⓪L-A1T13V⓪	
			DPDT	LB⓪L-A1T63⓪	LB⓪L-A1T23V⓪	LB⓪⓪L-A1T63⓪	LB⓪⓪L-A1T23V⓪	
		24V AC/DC	SPDT	LB⓪L-A1T54⓪	LB⓪L-A1T14V⓪	LB⓪⓪L-A1T54⓪	LB⓪⓪L-A1T14V⓪	
			DPDT	LB⓪L-A1T64⓪	LB⓪L-A1T24V⓪	LB⓪⓪L-A1T64⓪	LB⓪⓪L-A1T24V⓪	
Black Bezel with Guard 								

- For Standard Bezel part numbers specify:
 - Bezel shape in place of ⓪. 1 (round), 2 (square), 3 (rectangular)
 - Lens/LED color in place of ⓪. A (amber), G (green), PW (white), R (red), S (blue), Y (yellow)
- For Flush Bezel part numbers specify:
 - Lens/LED in place of ⓪. A (amber), G (green), PW (white), R (red), S (blue), Y (yellow)
 - Bezel shape in place of ⓪. 6 (round), 7 (square), 8 (rectangular)
 - Bezel material in place of ⓪. M (metallic), Blank (black), G (black with guard)
- Solder/Tab terminals have silver contacts and PC Board Terminals have gold contacts.
- Illuminated pushbuttons contain an LED unit.
- See page 24 for dimensions.
- See page 39 for replacement LED units.
- Illuminated pushbuttons can be used with legend markings. Engraving can be done on a marking plate which is placed in the lens, or a clear film can be printed and placed in the lens. See page 41 for details on the marking plate and film.

800.262.4332



www.IDEC.com/switches

Illuminated Pushbuttons

Illuminated Pushbuttons (Sub-assembled)







Contact Block

Terminal Style	Material	Contact	Part Number
	Silver	SPDT	LB-T50
		DPDT	LB-T60
	Gold	SPDT	LB-T10V
		DPDT	LB-T20V



LED Module

Style	Color	Voltage	Part Number
	Amber	5V	LB9Z-LED5A
		12V	LB9Z-LED1A
		24V	LB9Z-LED2A
	Green	5V	LB9Z-LED5G
		12V	LB9Z-LED1G
		24V	LB9Z-LED2G
	Red	5V	LB9Z-LED5R
		12V	LB9Z-LED1R
		24V	LB9Z-LED2R
	Blue	5V	LB9Z-LED5S
		12V	LB9Z-LED1S
		24V	LB9Z-LED2S
	White	5V	LB9Z-LED5PW
		12V	LB9Z-LED1PW
		24V	LB9Z-LED2PW
	Yellow	5V	LB9Z-LED5PW
		12V	LB9Z-LED1PW
		24V	LB9Z-LED2PW

Operator

Style	Mounting Style	Shape	Momentary	Maintained
	Standard (Plastic)	Round	LB1L-M0	LB1L-A0
		Square	LB2L-M0	LB2L-A0
		Rectangular	LB3L-M0	LB3L-A0
	Flush Mount (Plastic)	Round	LB6L-M0	LB6L-A0
		Square	LB7L-M0	LB7L-A0
		Rectangular	LB8L-M0	LB8L-A0
	Flush Mount (Metallic)	Round	LB6ML-M0	LB6ML-A0
		Square	LB7ML-M0	LB7ML-A0
		Rectangular	LB8ML-M0	LB8ML-A0
	Flush Mount (Built-in switch guard)	Round	LB6GL-M0	LB6GL-A0
		Square	LB7GL-M0	LB7GL-A0
		Rectangular	LB8GL-M0	LB8GL-A0

Lens

Shape	Color	Part Number
	Amber	LB1A-L1A
	Green	LB1A-L1G
	Red	LB1A-L1R
	Blue	LB1A-L1S
	White	LB1A-L1W
	Yellow	LB1A-L1Y
	Amber	LB2A-L1A
	Green	LB2A-L1G
	Red	LB2A-L1R
	Blue	LB2A-L1S
	White	LB2A-L1W
	Yellow	LB2A-L1Y
	Amber	LB3A-L1A
	Green	LB3A-L1G
	Red	LB3A-L1R
	Blue	LB3A-L1S
	White	LB3A-L1W
	Yellow	LB3A-L1Y

Pilot Lights (Assembled)

Style	Operating Voltage	Standard Bezel		Flush Bezel		② Color Code
		Solder/Tab Terminal (silver contacts)	PC Board Terminal (gold contacts)	Solder/Tab Terminal (silver contacts)	PC Board Terminal (gold contacts)	
Standard Bezel (black) 	5V DC	LB⓪P-⓪T01⓪	LB⓪P-⓪T01V⓪	LB⓪⓪P-⓪T01⓪	LB⓪⓪P-⓪T01V⓪	Specify the color code in place of ② in the Part Number.: A: amber G: green PW: white R: red S: blue Y: yellow
		LB⓪P-⓪T03⓪	LB⓪P-⓪T03V⓪	LB⓪⓪P-⓪T03⓪	LB⓪⓪P-⓪T03V⓪	
Flush Bezel (metallic or black) 	12V AC/DC	LB⓪P-⓪T03⓪	LB⓪P-⓪T03V⓪	LB⓪⓪P-⓪T03⓪	LB⓪⓪P-⓪T03V⓪	
		LB⓪P-⓪T04⓪	LB⓪P-⓪T04V⓪	LB⓪⓪P-⓪T04⓪	LB⓪⓪P-⓪T04V⓪	
	24V AC/DC	LB⓪P-⓪T04⓪	LB⓪P-⓪T04V⓪	LB⓪⓪P-⓪T04⓪	LB⓪⓪P-⓪T04V⓪	

- For Standard Bezel part numbers specify:
 - bezel shape in place of ①. 1 (round), 2 (square), 3 (rectangular)
 - lens/LED color in place of ②. A (amber), G (green), PW (white), R (red), S (blue), Y (yellow)
 - lens type code in place of ③. 1 (flat), 2 (dome with round lens)
- For Flush Bezel part numbers specify:
 - lens/LED in place of ②. A (amber), G (green), PW (white), R (red), S (blue), Y (yellow)
 - bezel shape in place of ③. 6 (round), 7 (square), 8 (rectangular)
 - bezel material in place of ④. M (metallic), Blank (black)
 - lens type code in place of ⑤. 1 (flat), 2 (dome with round lens)
- Pilot lights contain an LED unit.
- See page 25 for dimensions.
- See page 39 for replacement LED unit.

800.262.4332



www.IDEC.com/switches

Pilot Lights

Pilot Lights (Sub-assembled)



Contact Block

Terminal Style	Part Number
 Solder Tab	LB-T00
 PCB	LB-T00V



LED Module

Style	Color	Voltage	Part Number
	Amber	5V	LB9Z-LED5A
		12V	LB9Z-LED1A
		24V	LB9Z-LED2A
	Green	5V	LB9Z-LED5G
		12V	LB9Z-LED1G
		24V	LB9Z-LED2G
	Red	5V	LB9Z-LED5R
		12V	LB9Z-LED1R
		24V	LB9Z-LED2R
	Blue	5V	LB9Z-LED5S
		12V	LB9Z-LED1S
		24V	LB9Z-LED2S
	White	5V	LB9Z-LED5PW
		12V	LB9Z-LED1PW
		24V	LB9Z-LED2PW
	Yellow	5V	LB9Z-LED5PW
		12V	LB9Z-LED1PW
		24V	LB9Z-LED2PW

Operator

Style	Mounting Style	Shape	Part Number
	Standard (Plastic)	Round	LB1P-0
		Square	LB2P-0
		Rectangular	LB3P-0
	Flush Mount (Plastic)	Round	LB6P-0
		Square	LB7P-0
		Rectangular	LB8P-0
	Flush Mount (Metallic)	Round	LB6MP-0
		Square	LB7MP-0
		Rectangular	LB8MP-0

Lens

Shape	Color	Part Number
	Amber	LB1A-P1A
	Green	LB1A-P1G
	Red	LB1A-P1R
	Blue	LB1A-P1S
	White	LB1A-P1W
	Yellow	LB1A-P1Y
	Amber	LB1A-P2A
	Green	LB1A-P2G
	Red	LB1A-P2R
	Blue	LB1A-P2S
	White	LB1A-P2W
	Yellow	LB1A-P2Y
	Amber	LB2A-P1A
	Green	LB2A-P1G
	Red	LB2A-P1R
	Blue	LB2A-P1S
	White	LB2A-P1W
	Yellow	LB2A-P1Y
	Amber	LB3A-P1A
	Green	LB3A-P1G
	Red	LB3A-P1R
	Blue	LB3A-P1S
	White	LB3A-P1W
	Yellow	LB3A-P1Y

800.262.4332

www.IDEC.com/switches

Non-Illuminated Pushbuttons

Non-Illuminated Pushbuttons (Assembled)

Style	Operation	Contact	Standard Bezel		Flush Bezel		② Color Code
			Solder/Tab Terminal (silver contacts)	PC Board Terminal (gold contacts)	Solder/Tab Terminal (silver contacts)	PC Board Terminal (gold contacts)	
Standard Bezel (black)   	Momentary	SPDT	LB①B-M1T5②	LB①B-M1T1V②	LB③④B-M1T5②	LB③④B-M1T1V②	Specify the color code in place of ② in the Part Number: B: black G: green R: red S: blue W: white Y: yellow
		DPDT	LB①B-M1T6②	LB①B-M1T2V②	LB③④B-M1T6②	LB③④B-M1T2V②	
		3PDT	LB①B-M1T7②	LB①B-M1T3V②	LB③④B-M1T7②	LB③④B-M1T3V②	
Flush Bezel (metallic or black)   	Maintained	SPDT	LB①B-A1T5②	LB①B-A1T1V②	LB③④B-A1T5②	LB③④B-A1T1V②	
		DPDT	LB①B-A1T6②	LB①B-A1T2V②	LB③④B-A1T6②	LB③④B-A1T2V②	
		3PDT	LB①B-A1T7②	LB①B-A1T3V②	LB③④B-A1T7②	LB③④B-A1T3V②	
Black Bezel with Guard 							

1. For Standard Bezel part numbers specify:

- bezel shape in place of ①. 1 (round), 2 (square), 3 (rectangular)
- lens/LED in place of ②. B (black), G (green), R (red), S (blue), W (white), Y (yellow)

For Flush Bezel part numbers specify:

- lens/LED in place of ②. B (black), G (green), R (red), S (blue), W (white), Y (yellow)
- bezel shape in place of ③. 6 (round), 7 (square), 8 (rectangular)
- bezel material in place of ④. M (metallic), Blank (black), G (black with guard)

2. See page 26 for dimensions.



3. Lens can be used with legend markings. Engraving can be done on a marking plate which is placed into the lens, or a clear film can be printed and placed under the lens. For details on the marking plate and film, see page 41.

Non-Illuminated Pushbuttons

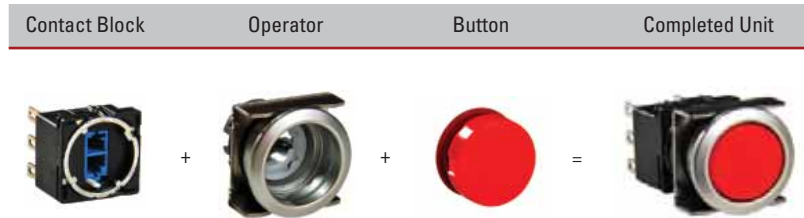
Non-Illuminated Pushbuttons (Sub-assembled)



Contact Block

Terminal Style	Material	Contact	Part Number
	Silver	SPDT	LB-T5
		DPDT	LB-T6
		3PDT	LB-T7
	Gold	SPDT	LB-T1V
		DPDT	LB-T2V
		3PDT	LB-T3V









Button

Style	Color	Part Number
	Black	LB1A-B1B
	Green	LB1A-B1G
	Red	LB1A-B1R
	Blue	LB1A-B1S
	White	LB1A-B1W
	Yellow	LB1A-B1Y
	Black	LB2A-B1B
	Green	LB2A-B1G
	Red	LB2A-B1R
	Blue	LB2A-B1S
	White	LB2A-B1W
	Yellow	LB2A-B1Y
	Black	LB3A-B1B
	Green	LB3A-B1G
	Red	LB3A-B1R
	Blue	LB3A-B1S
	White	LB3A-B1W
	Yellow	LB3A-B1Y

Operator

Style	Mounting style	Shape	Momentary	Maintained
	Standard (Plastic)	Round	LB1L-M0	LB1L-A0
		Square	LB2L-M0	LB2L-A0
		Rectangular	LB3L-M0	LB3L-A0
	Flush Mount (Plastic)	Round	LB6L-M0	LB6L-A0
		Square	LB7L-M0	LB7L-A0
		Rectangular	LB8L-M0	LB8L-A0
	Flush Mount (Metallic)	Round	LB6ML-M0	LB6ML-A0
		Square	LB7ML-M0	LB7ML-A0
		Rectangular	LB8ML-M0	LB8ML-A0
	Flush Mount (Built-in switch guard)	Round	LB6GL-M0	LB6GL-A0
		Square	LB7GL-M0	LB7GL-A0
		Rectangular	LB8GL-M0	LB8GL-A0

Selector Switches (Assembled)

Style	Operator Position	Contact	Standard Bezel		Flush Bezel	
			Solder/Tab Terminal (silver contacts)	PC Board Terminal (gold contacts)	Solder/Tab Terminal (silver contacts)	PC Board Terminal (gold contacts)
Standard Bezel (black)  lever shown	90° 2-position	Maintained 	SPDT LB①S-2⑤T5	LB①S-2⑤T1V	LB③④S-2⑤T5	LB③④S-2⑤T1V
		DPDT LB①S-2⑤T6	LB①S-2⑤T2V	LB③④S-2⑤T6	LB③④S-2⑤T2V	
		3PDT LB①S-2⑤T7	LB①S-2⑤T3V	LB③④S-2⑤T7	LB③④S-2⑤T3V	
		Spring return from right 	SPDT LB①S-21⑤T5	LB①S-21⑤T1V	LB③④S-21⑤T5	LB③④S-21⑤T1V
		DPDT LB①S-21⑤T6	LB①S-21⑤T2V	LB③④S-21⑤T6	LB③④S-21⑤T2V	
		3PDT LB①S-21⑤T7	LB①S-21⑤T3V	LB③④S-21⑤T7	LB③④S-21⑤T3V	
Flush Bezel (metallic or black)  lever shown	45° 3-position	Maintained 	DPDT LB①S-3⑤T6	LB①S-3⑤T2V	LB③④S-3⑤T6	LB③④S-3⑤T2V
		3PDT LB①S-3⑤T7	LB①S-3⑤T3V	LB③④S-3⑤T7	LB③④S-3⑤T3V	
		Spring return from right 	DPDT LB①S-31⑤T6	LB①S-31⑤T2V	LB③④S-31⑤T6	LB③④S-31⑤T2V
		3PDT LB①S-31⑤T7	LB①S-31⑤T3V	LB③④S-31⑤T7	LB③④S-31⑤T3V	
		Spring return from left 	DPDT LB①S-32⑤T6	LB①S-32⑤T2V	LB③④S-32⑤T6	LB③④S-32⑤T2V
		3PDT LB①S-32⑤T7	LB①S-32⑤T3V	LB③④S-32⑤T7	LB③④S-32⑤T3V	
		Spring return two-way 	DPDT LB①S-33⑤T6	LB①S-33⑤T2V	LB③④S-33⑤T6	LB③④S-33⑤T2V
		3PDT LB①S-33⑤T7	LB①S-33⑤T3V	LB③④S-33⑤T7	LB③④S-33⑤T3V	

Knob models shown above unless otherwise indicated.

- For Standard Bezel part numbers specify:
 - bezel shape in place of ①. 1 (round), 2 (square), 3 (rectangular)
 - operator shape in place of ⑤. blank (knob), L (lever).
- For Flush Bezel part numbers specify:
 - bezel shape in place of ③. 6 (round), 7 (square), 8 (rectangular)
 - bezel material in place of ④. M (metallic), Blank (black)
 - operator shape in place of ⑤. blank (knob), L (lever).
- See page 22 for contact operation .
- See page 28 for dimensions.

800.262.4332



www.IDEC.com/switches

Selector Switches

Selector Switches (Sub-assembled)



Contact Block

Terminal Style	Material	Contact	Part Number
	Solder/Tab	Silver	SPDT LB-T5
			DPDT LB-T6
			3PDT LB-T7
	PCB	Gold	SPDT LB-T1V
			DPDT LB-T2V
			3PDT LB-T3V

SPDT contacts applicable for 2-position switches only.











Operator

Style	Shape	Position	Function	Part Number	
				Knob	Lever
 Round	Round	2	Maintained	LB1S-2Y	LB1S-2L
			Spring from right	LB1S-21Y	LB1S-21L
		3	Maintained	LB1S-3Y	LB1S-3L
			Spring from right	LB1S-31Y	LB1S-31L
			Spring from left	LB1S-32Y	LB1S-32L
			Spring from both	LB1S-33Y	LB1S-33L
	Square	2	Maintained	LB2S-2Y	LB2S-2L
			Spring from right	LB2S-21Y	LB2S-21L
		3	Maintained	LB2S-3Y	LB2S-3L
			Spring from right	LB2S-31Y	LB2S-31L
			Spring from left	LB2S-32Y	LB2S-32L
			Spring from both	LB2S-33Y	LB2S-33L
Rectangular	2	Maintained	LB3S-2Y	LB3S-2L	
		Spring from right	LB3S-21Y	LB3S-21L	
	3	Maintained	LB3S-3Y	LB3S-3L	
		Spring from right	LB3S-31Y	LB3S-31L	
		Spring from left	LB3S-32Y	LB3S-32L	
		Spring from both	LB3S-33Y	LB3S-33L	

Style	Shape	Position	Function	Part Number	
				Knob	Lever
 Round	Round	2	Maintained	LB6S-2Y	LB6S-2L
			Spring from right	LB6S-21Y	LB6S-21L
		3	Maintained	LB6S-3Y	LB6S-3L
			Spring from right	LB6S-31Y	LB6S-31L
			Spring from left	LB6S-32Y	LB6S-32L
			Spring from both	LB6S-33Y	LB6S-33L
	Square	2	Maintained	LB7S-2Y	LB7S-2L
			Spring from right	LB7S-21Y	LB7S-21L
		3	Maintained	LB7S-3Y	LB7S-3L
			Spring from right	LB7S-31Y	LB7S-31L
			Spring from left	LB7S-32Y	LB7S-32L
			Spring from both	LB7S-33Y	LB7S-33L
 Round	Round	2	Maintained	LB6MS-2Y	LB6MS-2L
			Spring from right	LB6MS-21Y	LB6MS-21L
		3	Maintained	LB6MS-3Y	LB6MS-3L
			Spring from right	LB6MS-31Y	LB6MS-31L
			Spring from left	LB6MS-32Y	LB6MS-32L
			Spring from both	LB6MS-33Y	LB6MS-33L
	Square	2	Maintained	LB7MS-2Y	LB7MS-2L
			Spring from right	LB7MS-21Y	LB7MS-21L
		3	Maintained	LB7MS-3Y	LB7MS-3L
			Spring from right	LB7MS-31Y	LB7MS-31L
			Spring from left	LB7MS-32Y	LB7MS-32L
			Spring from both	LB7MS-33Y	LB7MS-33L
 Square	2	Maintained	LB8MS-2Y	LB8MS-2L	
		Spring from right	LB8MS-21Y	LB8MS-21L	
	3	Maintained	LB8MS-3Y	LB8MS-3L	
		Spring from right	LB8MS-31Y	LB8MS-31L	
		Spring from left	LB8MS-32Y	LB8MS-32L	
		Spring from both	LB8MS-33Y	LB8MS-33L	

Illuminated Selector Switches

Illuminated Selector Switches (Assembled)

Style	Operating Voltage	Operator Position		Contact	Standard Bezel		Flush Bezel	
					Solder/Tab Terminal (silver contacts)	PC Board Terminal (gold contacts)	Solder/Tab Terminal (silver contacts)	PC Board Terminal (gold contacts)
Standard Bezel (black)    Flush Bezel (metallic or black)   	5V DC	90° 2-position	Maintained 	SPDT	LB①F-2T51②	LB①F-2T11V②	LB6③F-2T51②	LB6③F-2T11V②
			DPDT	LB①F-2T61②	LB①F-2T21V②	LB6③F-2T61②	LB6③F-2T21V②	
	12V AC/DC	90° 2-position	Maintained 	SPDT	LB①F-2T53②	LB①F-2T13V②	LB6③F-2T53②	LB6③F-2T13V②
			DPDT	LB①F-2T63②	LB①F-2T23V②	LB6③F-2T63②	LB6③F-2T23V②	
	24V AC/DC	90° 2-position	Maintained 	SPDT	LB①F-2T54②	LB①F-2T14V②	LB6③F-2T54②	LB6③F-2T14V②
				DPDT	LB①F-2T64②	LB①F-2T24V②	LB6③F-2T64②	LB6③F-2T24V②
45° 3-position		Maintained 	DPDT	LB①F-3T61②	LB①F-3T21V②	LB6③F-3T61②	LB6③F-3T21V②	
			DPDT	LB①F-3T63②	LB①F-3T23V②	LB6③F-3T63②	LB6③F-3T23V②	
24V AC/DC	45° 3-position	Maintained 	DPDT	LB①F-3T64②	LB①F-3T24V②	LB6③F-3T64②	LB6③F-3T24V②	
			DPDT	LB①F-3T66②	LB①F-3T26V②	LB6③F-3T66②	LB6③F-3T26V②	

Flush bezel only available with round operator.

- For Standard Bezel part numbers specify:
 - bezel shape in place of ①. 1 (round), 2 (square), 3 (rectangular)
 - color code in place of ②. A (amber), G (green), R (red), S (blue), PW (white), Y (yellow)
- For Flush Bezel part numbers specify:
 - color code in place of ②. A (amber), G (green), R (red), S (blue), PW (white), Y (yellow)
 - bezel material in place of ③. M (metallic), Blank (black)
- See page 22 for contact operation.
- See page 30 for dimensions.

800.262.4332



www.IDEC.com/switches

Illuminated Selector Switches

Illuminated Selector Switches (Sub-assembled)



Contact Block

Terminal Style	Material	Contact	Part Number
 Solder/Tab	Silver	SPDT	LB-T50
		DPDT	LB-T60
	Gold	SPDT	LB-T10
		DPDT	LB-T20
 PCB	Gold	SPDT	LB-T10V
		DPDT	LB-T20V

SPDT contacts applicable for 2-position switches only.

Operator

Style	Shape	Position	Function	Part Number
 Standard (Plastic)	Round	2	Maintained	LB1F-2
		3	Maintained	LB1F-3
	Square	2	Maintained	LB2F-2
		3	Maintained	LB2F-3
	Rectangular	2	Maintained	LB3F-2
		3	Maintained	LB3F-3
 Flush Mount (Plastic)	Round	2	Maintained	LB6F-2
		3	Maintained	LB6F-3
 Flush Mount (Metallic)	Round	2	Maintained	LB6MF-2
		3	Maintained	LB6MF-3

LED Module

Style	Color	Voltage	Part Number
	Amber	5V	LB9Z-LED5A
		12V	LB9Z-LED1A
		24V	LB9Z-LED2A
	Green	5V	LB9Z-LED5G
		12V	LB9Z-LED1G
		24V	LB9Z-LED2G
Red	5V	LB9Z-LED5R	
	12V	LB9Z-LED1R	
	24V	LB9Z-LED2R	
Blue	5V	LB9Z-LED5S	
	12V	LB9Z-LED1S	
	24V	LB9Z-LED2S	
White	5V	LB9Z-LED5PW	
	12V	LB9Z-LED1PW	
	24V	LB9Z-LED2PW	
Yellow	5V	LB9Z-LED5PY	
	12V	LB9Z-LED1PY	
		24V	LB9Z-LED2PY

Lens Handle

Style	Color	Part Number
	Amber	LA1A-FA
	Green	LA1A-FG
	Red	LA1A-FR
	Blue	LA1A-FS
	White	LA1A-FW
	Yellow	LA1A-FY

800.262.4332

www.IDEC.com/switches

Key Selector Switches

Key Selector Switches (Assembled)

Style	Operator Position	Key retained at ●	Contact	Standard Bezel		Flush Bezel		
				Solder/Tab Terminal (silver contacts)	PC Board Terminal (gold contacts)	Solder/Tab Terminal (silver contacts)	PC Board Terminal (gold contacts)	
Standard Bezel (black) 	90° 2-position	Maintained	A 	SPDT	LB⓪K-2T5A	LB⓪K-2T1VA	LB⓪⓪K-2T5A	LB⓪⓪K-2T1VA
				DPDT	LB⓪K-2T6A	LB⓪K-2T2VA	LB⓪⓪K-2T6A	LB⓪⓪K-2T2VA
				3PDT	LB⓪K-2T7A	LB⓪K-2T3VA	LB⓪⓪K-2T7A	LB⓪⓪K-2T3VA
		B 	SPDT	LB⓪K-2T5B	LB⓪K-2T1VB	LB⓪⓪K-2T5B	LB⓪⓪K-2T1VB	
			DPDT	LB⓪K-2T6B	LB⓪K-2T2VB	LB⓪⓪K-2T6B	LB⓪⓪K-2T2VB	
			3PDT	LB⓪K-2T7B	LB⓪K-2T3VB	LB⓪⓪K-2T7B	LB⓪⓪K-2T3VB	
	C 	SPDT	LB⓪K-2T5C	LB⓪K-2T1VC	LB⓪⓪K-2T5C	LB⓪⓪K-2T1VC		
		DPDT	LB⓪K-2T6C	LB⓪K-2T2VC	LB⓪⓪K-2T6C	LB⓪⓪K-2T2VC		
		3PDT	LB⓪K-2T7C	LB⓪K-2T3VC	LB⓪⓪K-2T7C	LB⓪⓪K-2T3VC		
	Spring return from right	B 	SPDT	LB⓪K-21T5B	LB⓪K-21T1VB	LB⓪⓪K-21T5B	LB⓪⓪K-21T1VB	
			DPDT	LB⓪K-21T6B	LB⓪K-21T2VB	LB⓪⓪K-21T6B	LB⓪⓪K-21T2VB	
			3PDT	LB⓪K-21T7B	LB⓪K-21T3VB	LB⓪⓪K-21T7B	LB⓪⓪K-21T3VB	
A 		DPDT	LB⓪K-3T6A	LB⓪K-3T2VA	LB⓪⓪K-3T6A	LB⓪⓪K-3T2VA		
		3PDT	LB⓪K-3T7A	LB⓪K-3T3VA	LB⓪⓪K-3T7A	LB⓪⓪K-3T3VA		
		B 	DPDT	LB⓪K-3T6B	LB⓪K-3T2VB	LB⓪⓪K-3T6B	LB⓪⓪K-3T2VB	
3PDT	LB⓪K-3T7B		LB⓪K-3T3VB	LB⓪⓪K-3T7B	LB⓪⓪K-3T3VB			
C 	DPDT		LB⓪K-3T6C	LB⓪K-3T2VC	LB⓪⓪K-3T6C	LB⓪⓪K-3T2VC		
	3PDT	LB⓪K-3T7C	LB⓪K-3T3VC	LB⓪⓪K-3T7C	LB⓪⓪K-3T3VC			
	D 	DPDT	LB⓪K-3T6D	LB⓪K-3T2VD	LB⓪⓪K-3T6D	LB⓪⓪K-3T2VD		
3PDT		LB⓪K-3T7D	LB⓪K-3T3VD	LB⓪⓪K-3T7D	LB⓪⓪K-3T3VD			
E 		DPDT	LB⓪K-3T6E	LB⓪K-3T2VE	LB⓪⓪K-3T6E	LB⓪⓪K-3T2VE		
	3PDT	LB⓪K-3T7E	LB⓪K-3T3VE	LB⓪⓪K-3T7E	LB⓪⓪K-3T3VE			
	G 	DPDT	LB⓪K-3T6G	LB⓪K-3T2VG	LB⓪⓪K-3T6G	LB⓪⓪K-3T2VG		
3PDT		LB⓪K-3T7G	LB⓪K-3T3VG	LB⓪⓪K-3T7G	LB⓪⓪K-3T3VG			
H 		DPDT	LB⓪K-3T6H	LB⓪K-3T2VH	LB⓪⓪K-3T6H	LB⓪⓪K-3T2VH		
	3PDT	LB⓪K-3T7H	LB⓪K-3T3VH	LB⓪⓪K-3T7H	LB⓪⓪K-3T3VH			

Flush Bezel (metallic or black)



Assembled Key Selector Switches con't on next page.

Key Selector Switches

Key Selector Switches con't

Style	Operator Position	Key retained at ●	Contact	Standard Bezel		Flush Bezel						
				Solder/Tab Terminal (silver contacts)	PC Board Terminal (gold contacts)	Solder/Tab Terminal (silver contacts)	PC Board Terminal (gold contacts)					
	45° 3-position	Spring return from right	B	●	○	○	○	DPDT	LB⊙K-31T6B	LB⊙K-31T2VB	LB⊙⊙K-31T6B	LB⊙⊙K-31T2VB
				○	○	○	○	3PDT	LB⊙K-31T7B	LB⊙K-31T3VB	LB⊙⊙K-31T7B	LB⊙⊙K-31T3VB
			D	●	○	○	○	DPDT	LB⊙K-31T6D	LB⊙K-31T2VD	LB⊙⊙K-31T6D	LB⊙⊙K-31T2VD
				○	○	○	○	3PDT	LB⊙K-31T7D	LB⊙K-31T3VD	LB⊙⊙K-31T7D	LB⊙⊙K-31T3VD
			G	●	○	○	○	DPDT	LB⊙K-31T6G	LB⊙K-31T2VG	LB⊙⊙K-31T6G	LB⊙⊙K-31T2VG
				○	○	○	○	3PDT	LB⊙K-31T7G	LB⊙K-31T3VG	LB⊙⊙K-31T7G	LB⊙⊙K-31T3VG
		Spring return from left	C	●	○	○	○	DPDT	LB⊙K-32T6C	LB⊙K-32T2VC	LB⊙⊙K-32T6C	LB⊙⊙K-32T2VC
				○	○	○	○	3PDT	LB⊙K-32T7C	LB⊙K-32T3VC	LB⊙⊙K-32T7C	LB⊙⊙K-32T3VC
			D	●	○	○	○	DPDT	LB⊙K-32T6D	LB⊙K-32T2VD	LB⊙⊙K-32T6D	LB⊙⊙K-32T2VD
				○	○	○	○	3PDT	LB⊙K-32T7D	LB⊙K-32T3VD	LB⊙⊙K-32T7D	LB⊙⊙K-32T3VD
			H	●	○	○	○	DPDT	LB⊙K-32T6H	LB⊙K-32T2VH	LB⊙⊙K-32T6H	LB⊙⊙K-32T2VH
				○	○	○	○	3PDT	LB⊙K-32T7H	LB⊙K-32T3VH	LB⊙⊙K-32T7H	LB⊙⊙K-32T3VH
Spring return two-way	D	●	○	○	○	DPDT	LB⊙K-33T6D	LB⊙K-33T2VD	LB⊙⊙K-33T6D	LB⊙⊙K-33T2VD		
		○	○	○	○	3PDT	LB⊙K-33T7D	LB⊙K-33T3VD	LB⊙⊙K-33T7D	LB⊙⊙K-33T3VD		

- Key is retained at ● and removable at ○ positions.
- Two keys are supplied.
- For Standard Bezel part numbers specify bezel shape in place of ⊙. 1 (round), 2 (square), 3 (rectangular)
- For Flush Bezel part numbers specify:
 - bezel shape in place of ⊙. 6 (round), 7 (square), 8 (rectangular)
 - bezel material in place of ⊙. M (metallic), Blank (black)
- See page 22 for contact operation.
- See page 31 for dimensions.
- For additional security, wave keys also available.
 Add the letter "S" before the "T" in the part no. Example: LB1K-31ST1A
 Besides the standard wave key (key number 0H), six other keys are available.
 To order other keys, specify the key number as shown below:
 Example: LB1K-31ST2B-1H (Key number is indicated on the key cylinder. Standard keys do not have a key number indication.)
 - (blank): Standard wave key (0H)
 - 1H to 2H: Reversible wave key
 - 3H to 6H: Non-reversible wave key
- If ordering standard wave key (0H), subcomponents are available, see next page.
- If ordering other than standard wave key (for example, key number 6H), only completed switches are available.



800.262.4332

www.IDEC.com/switches

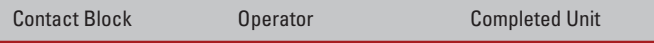
Key Selector Switches (Sub-assembled)





Contact Block

Terminal Style	Material	Contact	Part Number
	Solder/Tab	Silver	SPDT LB-T5
			DPDT LB-T6
			3PDT LB-T7
	PCB	Gold	SPDT LB-T1V
			DPDT LB-T2V
			3PDT LB-T3V

Operator

Style	Shape	Position	Function	Part number
	Round	2	Maintained LB1K-2 [Ⓢ]	
			Spring from right LB1K-21B	
		3	Maintained LB1K-3 [Ⓢ]	
			Spring from right LB1K-31 [Ⓢ]	
			Spring from left LB1K-32 [Ⓢ]	
			Spring from both LB1K-33D	
	Square	2	Maintained LB2K-2 [Ⓢ]	
			Spring from right LB2K-21B	
		3	Maintained LB2K-3 [Ⓢ]	
			Spring from right LB2K-31 [Ⓢ]	
			Spring from left LB2K-32 [Ⓢ]	
			Spring from both LB2K-33D	
	Rectangular	2	Maintained LB3K-2 [Ⓢ]	
			Spring from right LB3K-21B	
		3	Maintained LB3K-3 [Ⓢ]	
Spring from right LB3K-31 [Ⓢ]				
Spring from left LB3K-32 [Ⓢ]				
Spring from both LB3K-33D				

Style	Shape	Position	Function	Part number
	Round	2	Maintained LB6K-2 [Ⓢ]	
			Spring from right LB6K-21B	
		3	Maintained LB6K-3 [Ⓢ]	
			Spring from right LB6K-31 [Ⓢ]	
			Spring from left LB6K-32 [Ⓢ]	
			Spring from both LB6K-33D	
	Square	2	Maintained LB7K-2 [Ⓢ]	
			Spring from right LB7K-21B	
		3	Maintained LB7K-3 [Ⓢ]	
			Spring from right LB7K-31 [Ⓢ]	
			Spring from left LB7K-32 [Ⓢ]	
			Spring from both LB7K-33D	
	Rectangular	2	Maintained LB8K-2 [Ⓢ]	
			Spring from right LB8K-21B	
		3	Maintained LB8K-3 [Ⓢ]	
Spring from right LB8K-31 [Ⓢ]				
Spring from left LB8K-32 [Ⓢ]				
Spring from both LB8K-33D				
	Round	2	Maintained LB6MK-2 [Ⓢ]	
			Spring from right LB6MK-21B	
		3	Maintained LB6MK-3 [Ⓢ]	
			Spring from right LB6MK-31 [Ⓢ]	
			Spring from left LB6MK-32 [Ⓢ]	
			Spring from both LB6MK-33D	
	Square	2	Maintained LB7MK-2 [Ⓢ]	
			Spring from right LB7MK-21B	
		3	Maintained LB7MK-3 [Ⓢ]	
			Spring from right LB7MK-31 [Ⓢ]	
			Spring from left LB7MK-32 [Ⓢ]	
			Spring from both LB7MK-33D	
	Rectangular	2	Maintained LB8MK-2 [Ⓢ]	
			Spring from right LB8MK-21B	
		3	Maintained LB8MK-3 [Ⓢ]	
Spring from right LB8MK-31 [Ⓢ]				
Spring from left LB8MK-32 [Ⓢ]				
Spring from both LB8MK-33D				

1. In place of [Ⓢ] specify retention option code from table below.
2. For standard wave key operators, add "S" to part number before the key retention code from table below. (For example, LB6K-2B with wave key would be LB6K-2SB.)

[Ⓢ] Retention Option Code

Code	Description
A	Key not retained in any position (removable in all positions)
B	Key retained in right position only
C	Key retained in left position only
D	Key retained in left and right (3-position only)

Code	Description
E	Key retained in center only (3-position only)
G	Key retained in right and center (3-position only)
H	Key retained in left and center (3-position only)

Lever Switches

Lever Switches (Assembled)



Style	Operator Position		Contact	Solder/Tab Terminal (silver contacts)	PC Board Terminal (gold contacts)
 Standard Bezel (black)	2-position	Maintained 	SPDT	LB \odot T-2T5	LB \odot T-2T1V
			DPDT	LB \odot T-2T6	LB \odot T-2T2V
			3PDT	LB \odot T-2T7	LB \odot T-2T3V
 Flush Bezel (black)	3-position	Maintained 	DPDT	LB \odot T-3T2	LB \odot T-3T6V
			3PDT	LB \odot T-3T3	LB \odot T-3T7V
		Spring return from top/bottom 	DPDT	LB \odot T-33T2	LB \odot T-33T6V
			3PDT	LB \odot T-33T3	LB \odot T-33T7V

1. For all part numbers, specify bezel in place of \odot . 1 (standard bezel), 6 (flush bezel).
2. See page 22 for contact operation.
3. See page 33 for dimensions.



Lever Switches (Sub-assembled)



Contact Block

Terminal Style	Material	Contact	Part Number
 Solder/Tab	Silver	SPDT	LB-T5
		DPDT	LB-T6
		3PDT	LB-T7
	Gold	SPDT	LB-T1
		DPDT	LB-T2
		3PDT	LB-T3
 PCB	Gold	SPDT	LB-T1V
		DPDT	LB-T2V
		3PDT	LB-T3V

Operator

Style	Position	Function	Part Number
 Round Standard (Plastic)	2	Maintained	LB1T-2
		Maintained	LB1T-3
	3	Spring return from both	LB1T-33
 Round Flush Mount (Plastic)	2	Maintained	LB6T-2
		Maintained	LB6T-3
	3	Spring return from both	LB6T-33

800.262.4332

www.IDEC.com/switches

Buzzers (Assembled)

Style	Shape	Voltage	Standard Bezel		Flush Bezel	
			Solder/Tab Terminal	PC Board Terminal	Solder/Tab Terminal	PC Board Terminal
Black Bezel   	Round	12V DC	-	-	LB6Z-1T03	LB6Z-1T03V
		24V DC	-	-	LB6Z-1T04	LB6Z-1T04V
	Rectangular	12V DC	LB3Z-1T03	LB3Z-1T03V	LB8Z-1T03	LB8Z-1T03V
		24V DC	LB3Z-1T04	LB3Z-1T04V	LB8Z-1T04	LB8Z-1T04V
Metallic Bezel  	Round	12V DC	-	-	LB6MZ-1T03	LB6MZ-1T03V
		24V DC	-	-	LB6MZ-1T04	LB6MZ-1T04V
	Rectangular	12V DC	-	-	LB8MZ-1T03	LB8MZ-1T03V
		24V DC	-	-	LB8MZ-1T04	LB8MZ-1T04V

1. IP54 Rated.
2. For IP40 rating, use part number LB3Z-104K.
3. See page 34 for dimensions.

Buzzers (Sub-assembled)



Contact Block

Terminal Style	Part Number
 Solder/Tab	LB-T00
 PCB	LB-T00V

Operator

Style	Mounting Style	Shape	Voltage	
			12V DC	24V DC
	Standard (Plastic)	Rectangular	LB3Z-103	LB3Z-104
	Flush Mount (Plastic)	Round	LB6Z-103	LB6Z-104
		Rectangular	LB8Z-103	LB8Z-104
	Flush Mount (Metallic)	Round	LB6MZ-103	LB6MZ-104
		Rectangular	LB8MZ-103	LB8MZ-104

Contact Operations & Dimensions (mm)

Contact Operation

Selector Switch, Illuminated Selector Switch, Key Selector Switch

Operator Position & Contact Operation (Top View)					
Position		Contact	↙ Left	↑ Center	↘ Right
90° 2-position	<p>Maintained</p> <p>Spring return from right</p>	SPDT			
		DPDT			
		3PDT			
45° 3-position	<p>Maintained</p> <p>Spring return from right</p> <p>Spring return from left</p> <p>Spring return two-way</p>	DPDT			
		3PDT			
		DPDT			
		3PDT			

Lever Switch

Lever Position & Contact Operation (Top View)					
Position		Contact	Down	Center	Up
90° 2-position	<p>Maintained</p>	SPDT			
		DPDT			
		3PDT			
45° 3-position	<p>Maintained</p> <p>Spring return two-way</p>	DPDT			
		3PDT			

Mounting Hole Layout (mm)

Standard Bezels

LB1/LB2/LB3

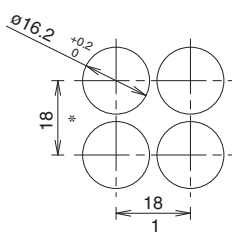

*1. Rectangular: 24mm
3PDT: 23.2mm
*2. 3PDT: 21mm

Flush Bezels

Round

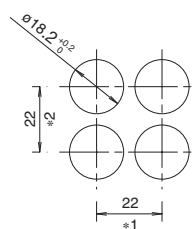

Square

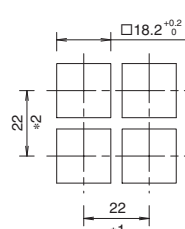

Rectangular

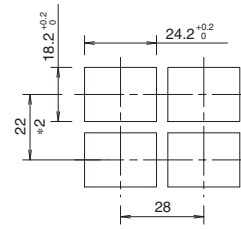

*1. 3PDT: 23.2mm
*2. Switches with Guard: 45mm

PC Board Drilling Layout (mm)

Notes for Designing PC Board and Circuit

1. Use 1.6mm-thick glass epoxy PC board with drilled holes.
2. Design a circuit so that the LB series can operate within the rated voltage and current range. Make sure that inrush current and voltage do not exceed the rating.
3. Minimum applicable load is 5V AC/DC, 1mA on gold contacts.
4. Since the *2.8mm-wide terminal touches the PC board as shown below, short circuit may occur with pattern lines. Design a circuit that prevents short circuits.

SPDT/DPDT Contacts

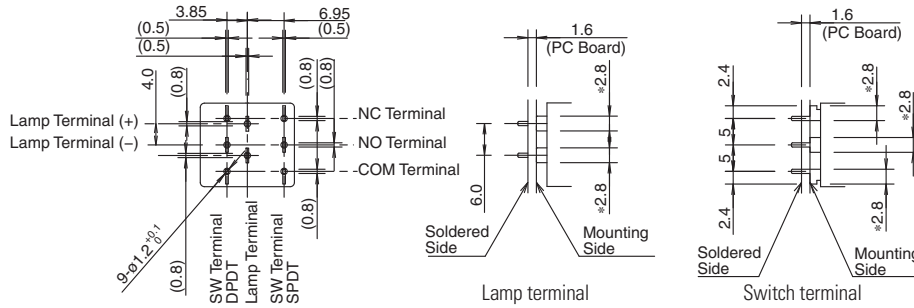

3PDT Contacts

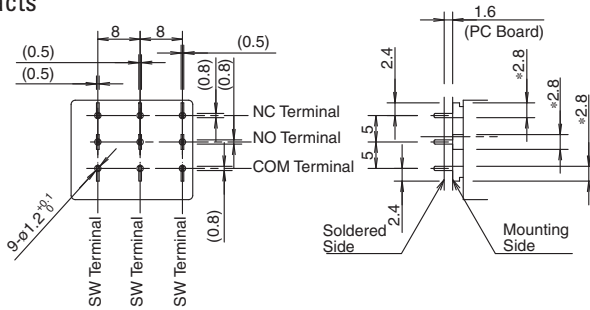

PC Board Drilling Layout (Bottom View)

SPDT/DPDT Contacts

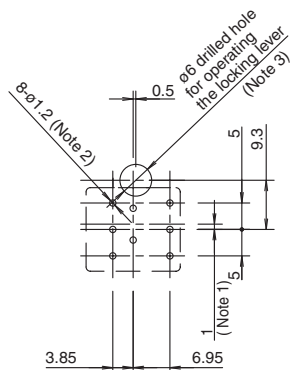

3PDT Contacts

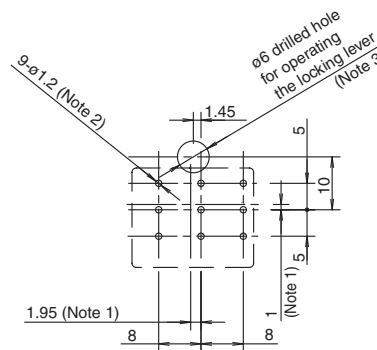

1. When designing, note the alignment of the center lines of the contact blocks and operators.
2. The diameter of the terminal hole is $\phi 1.2$.
3. Hole diameter may vary to meet installation requirements. Determine the location and the size of the hole so that the locking lever can be operated.

800.262.4332

www.IDEC.com/switches

Dimensions (mm)

Illuminated Pushbutton

Standard Bezels

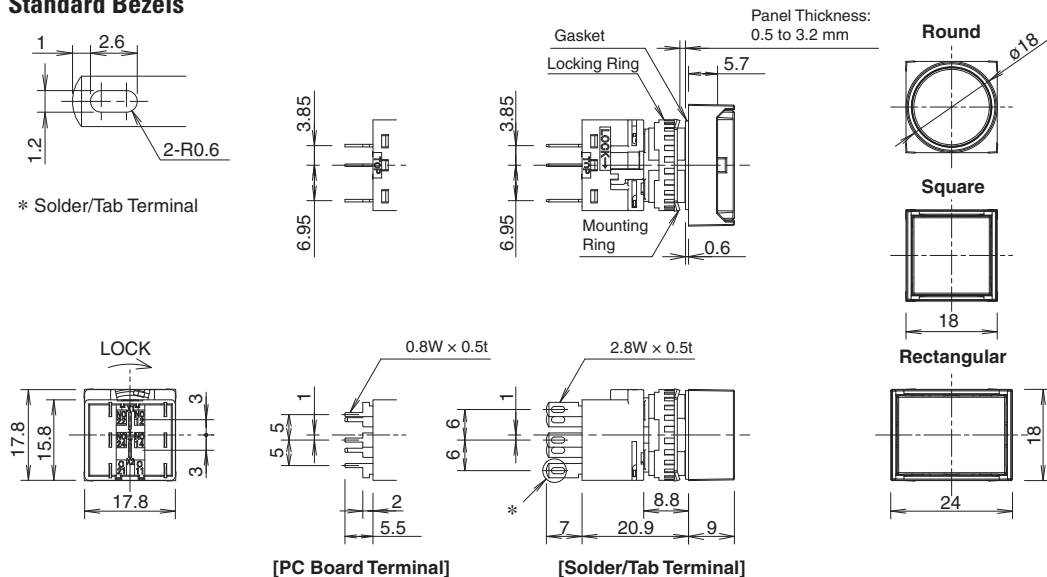

Flush Bezels

SPDT/DPDT Contacts

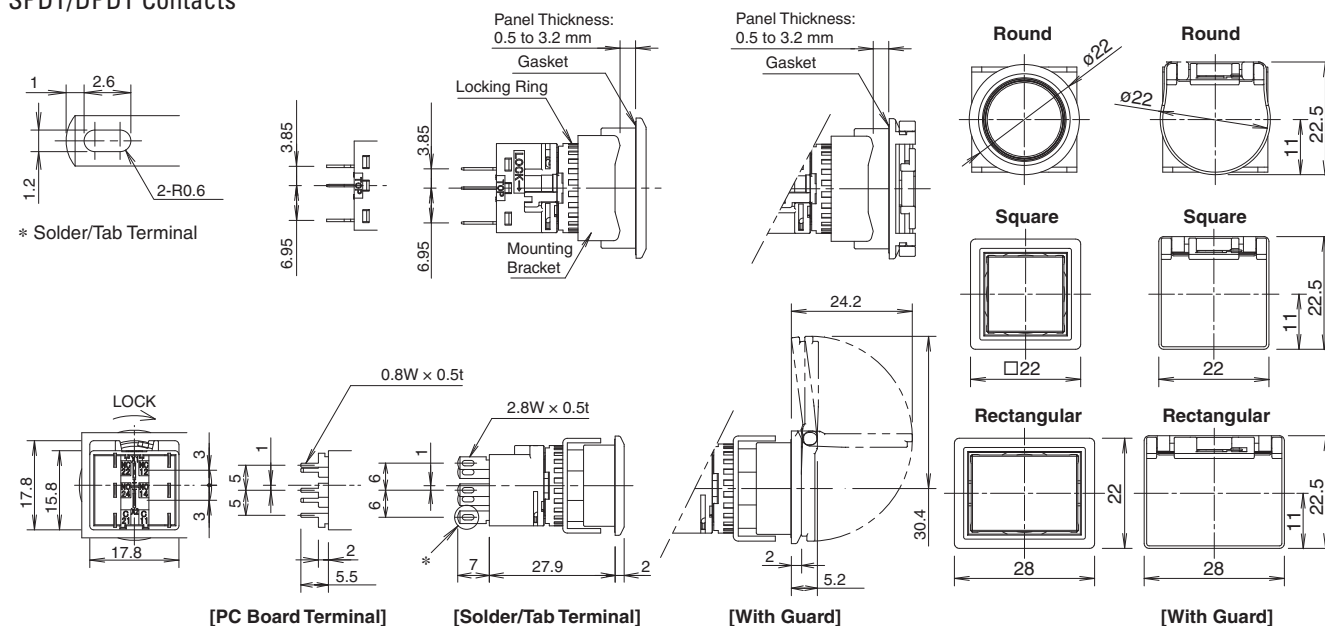

Terminal Arrangement (Bottom View)

Illuminated Pushbuttons

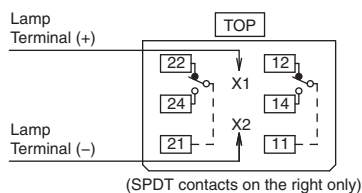

Pilot Lights

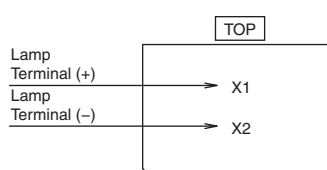

800.262.4332

www.IDEC.com/switches

Pilot Lights

Standard Bezels

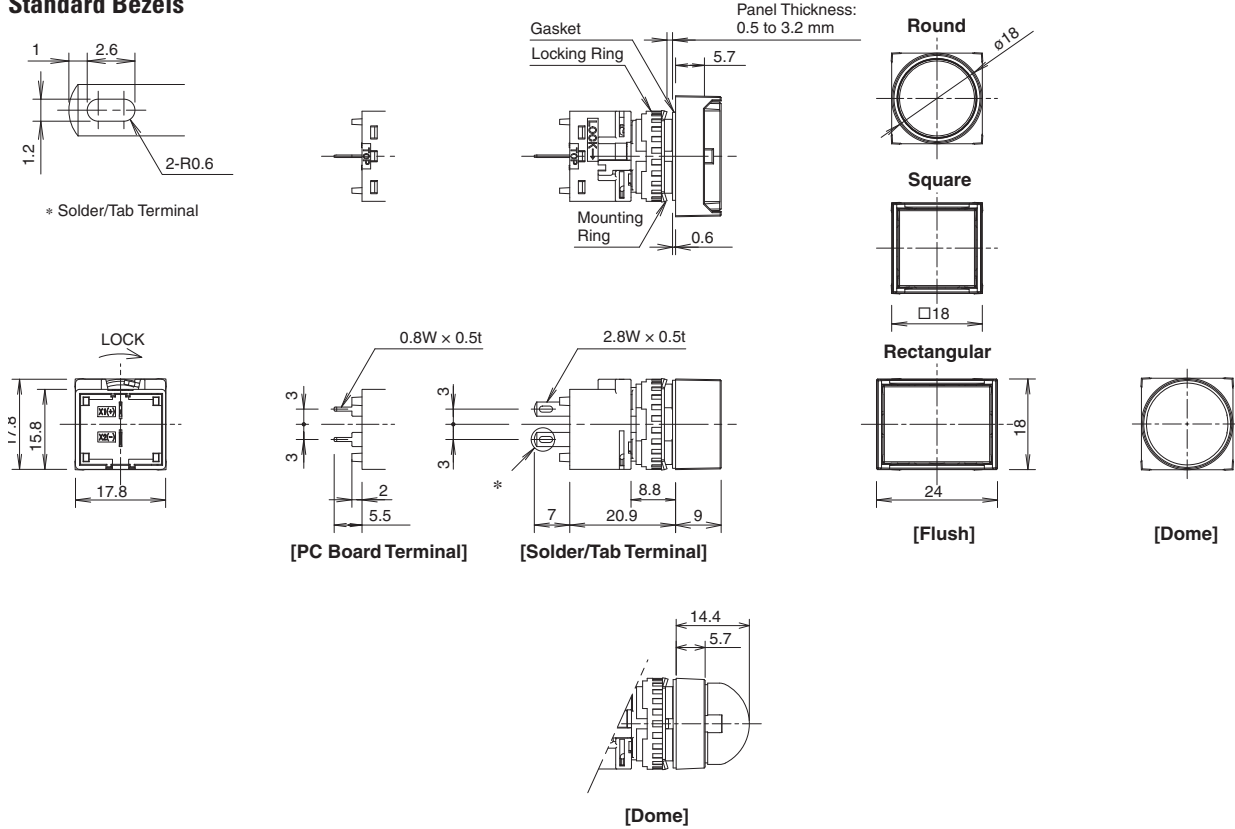

Flush Bezels

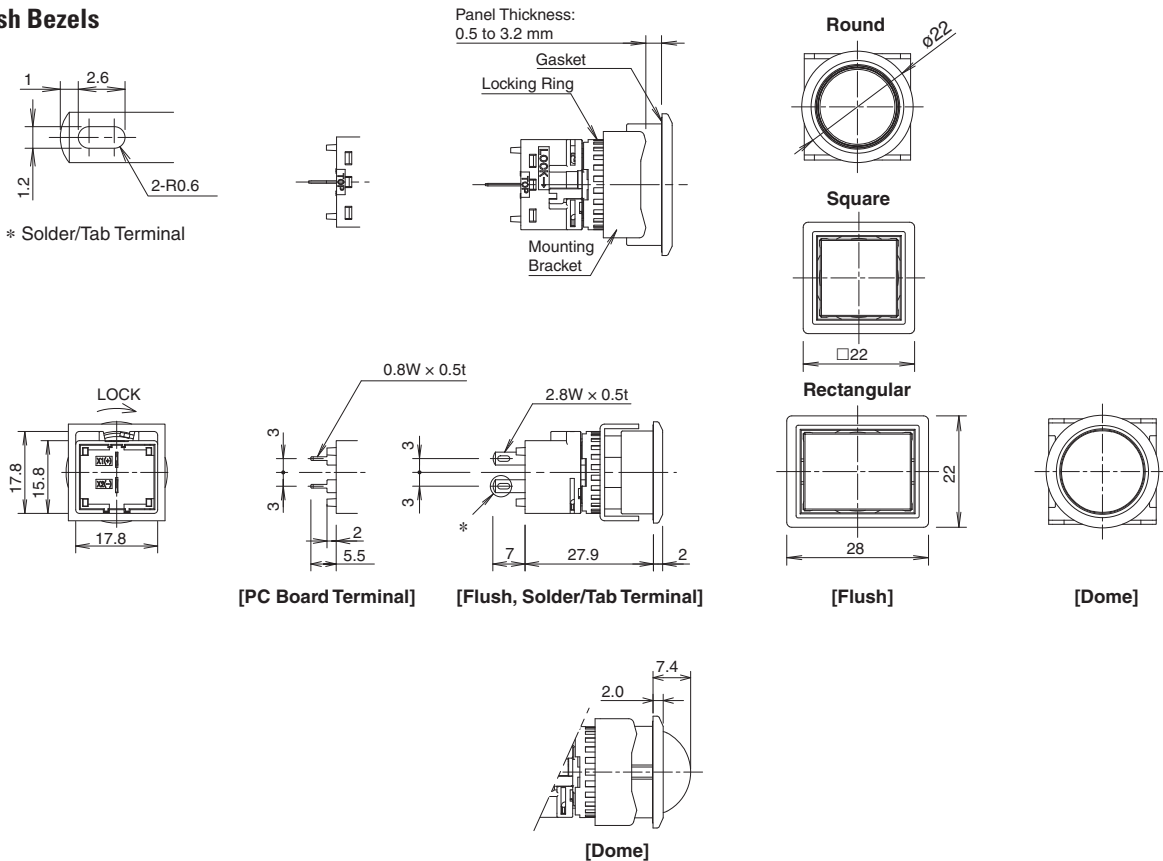

Dimensions (mm)

Non-Illuminated Pushbuttons

Standard Bezels

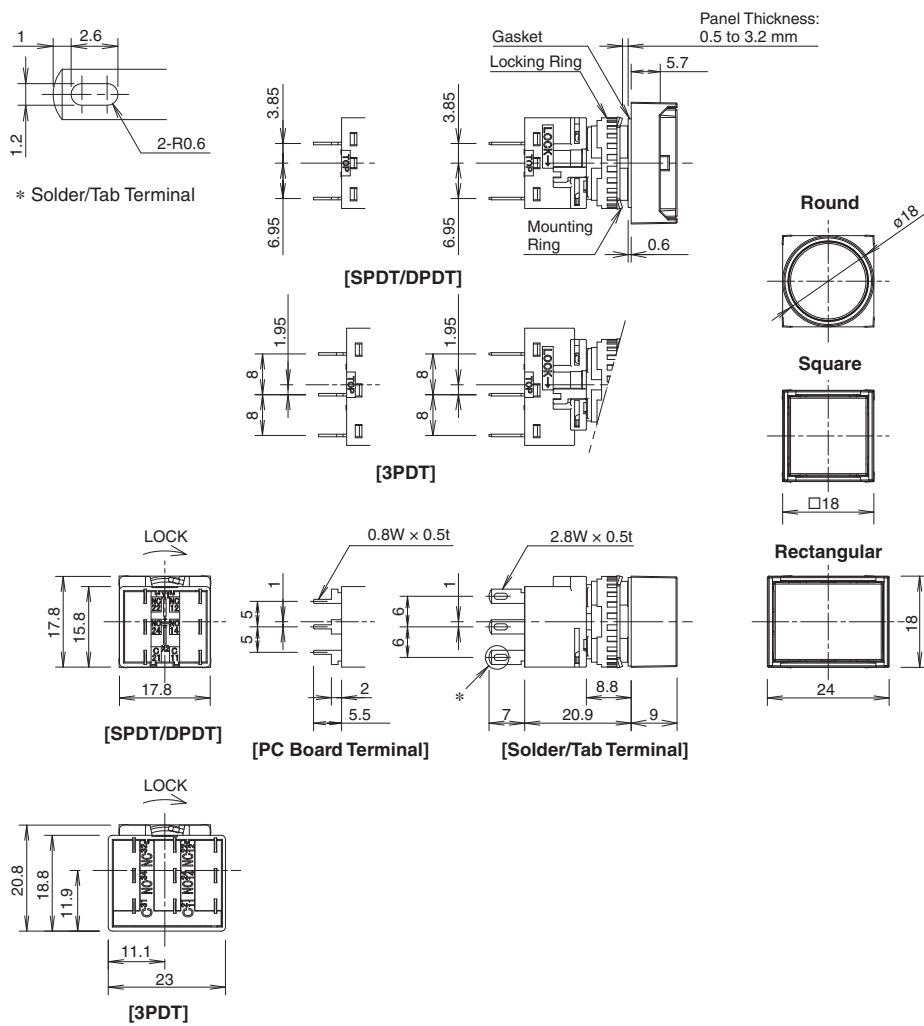

Terminal Arrangement (Bottom View)

SPDT/DPDT Contacts

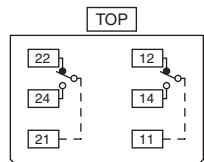

(SPDT contacts on the right only)

3PDT Contacts

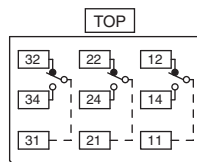

Non-Illuminated Pushbuttons

Flush Bezels

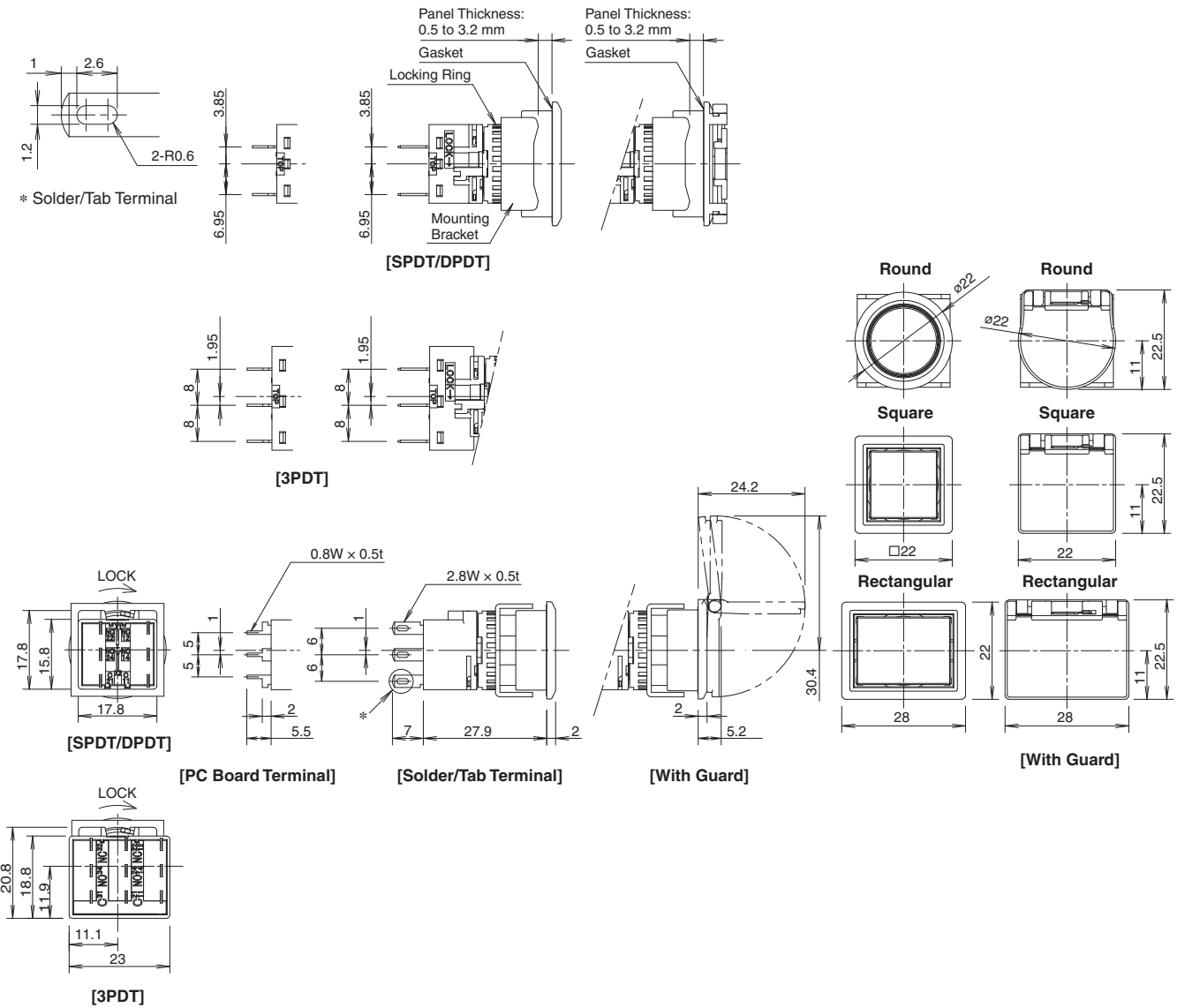

800.262.4332

www.IDEC.com/switches

Dimensions (mm)

Selector Switches

Standard Bezels

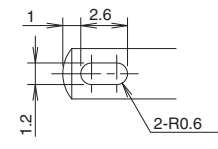

* Solder/Tab Terminal

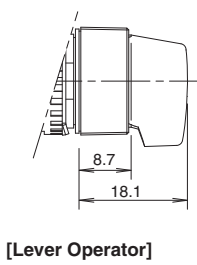
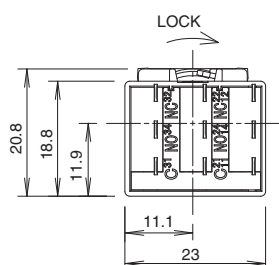
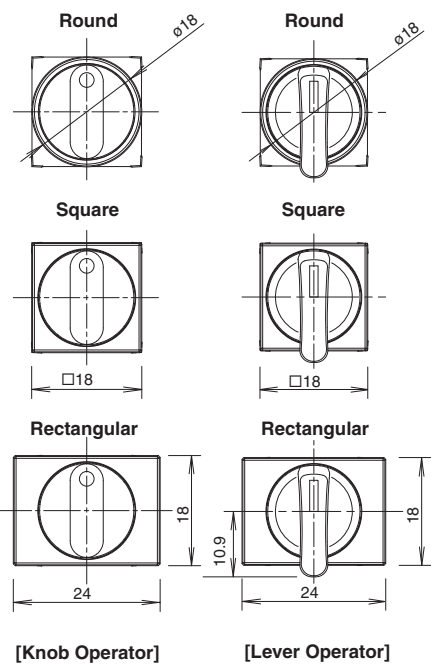
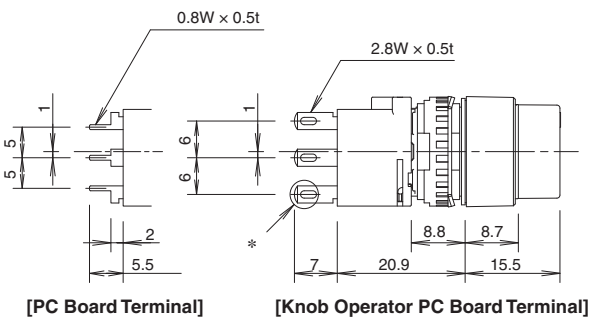
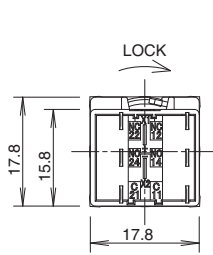
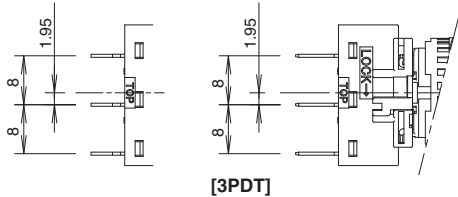
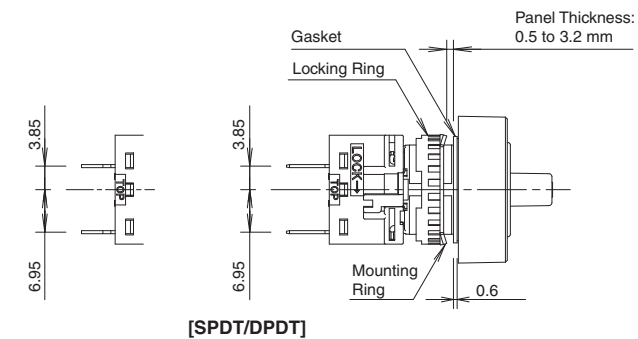

800.262.4332

www.IDEC.com/switches

Selector Switches

Flush Bezels

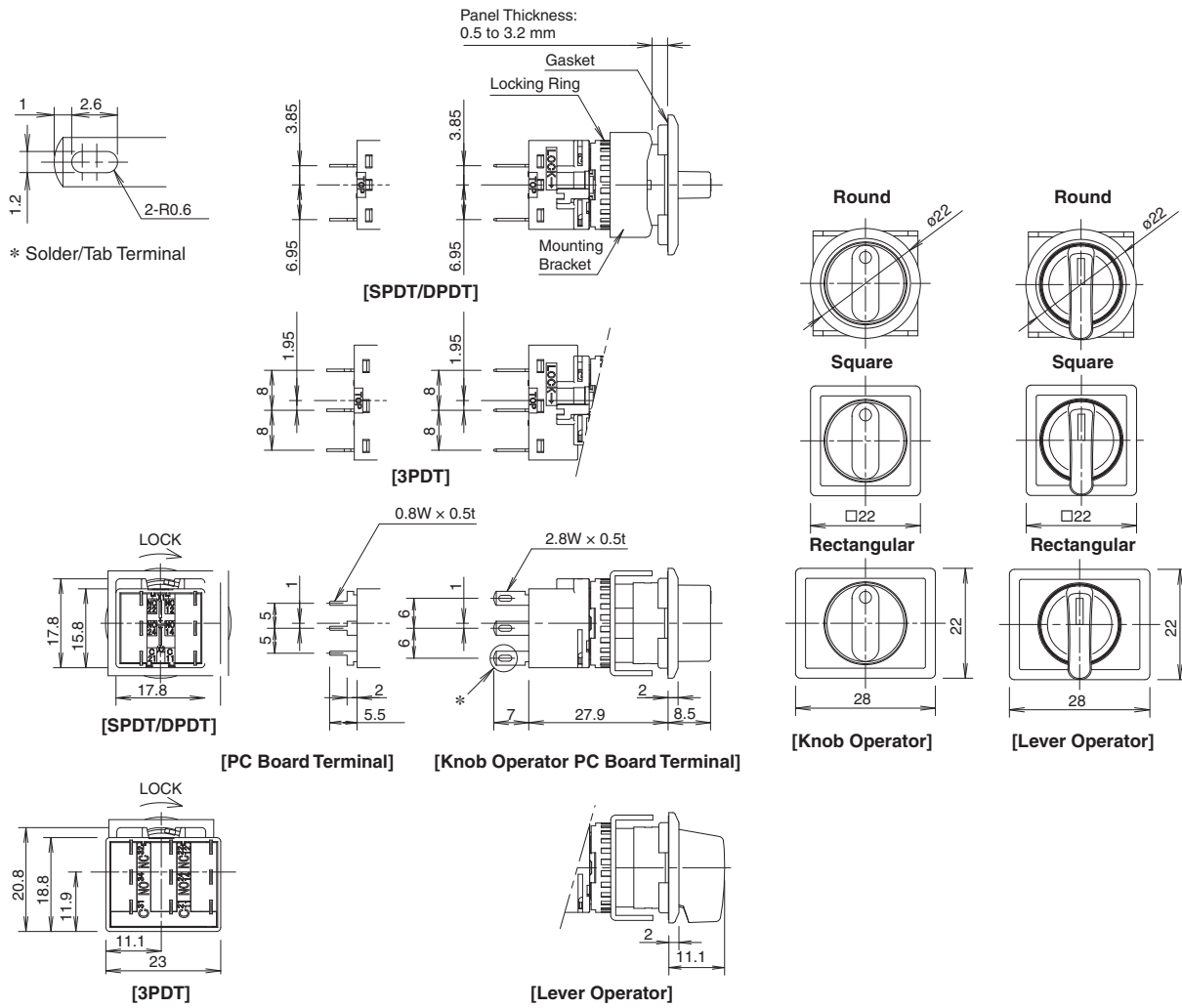

Terminal Arrangement (Bottom View)

SPDT/DPDT Contacts

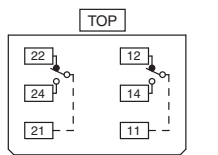

(SPDT contacts on the right only)

3PDT Contacts

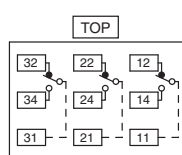

Dimensions (mm)

Illuminated Selector Switches

Standard Bezels

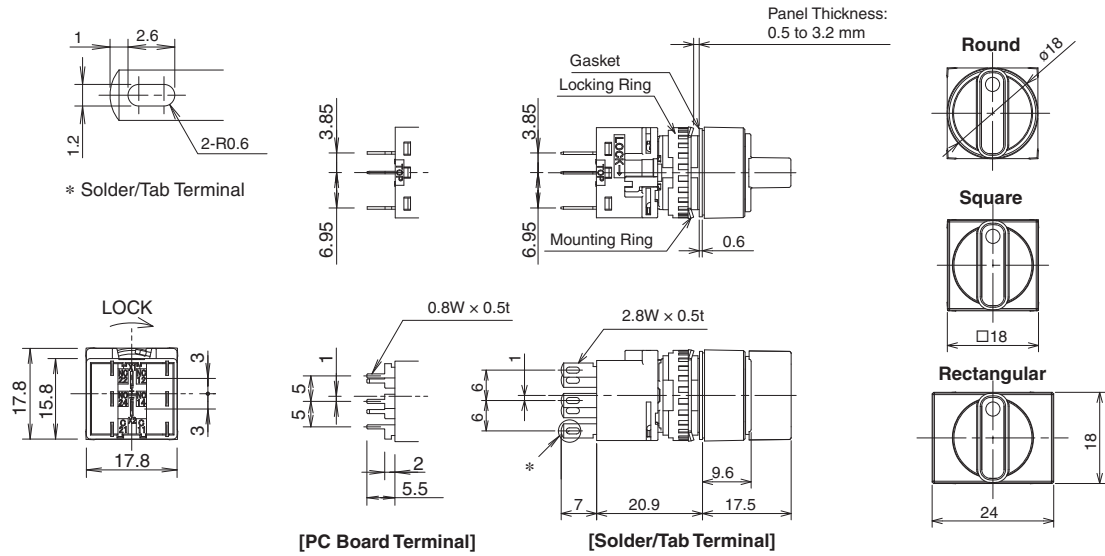

Flush Bezels

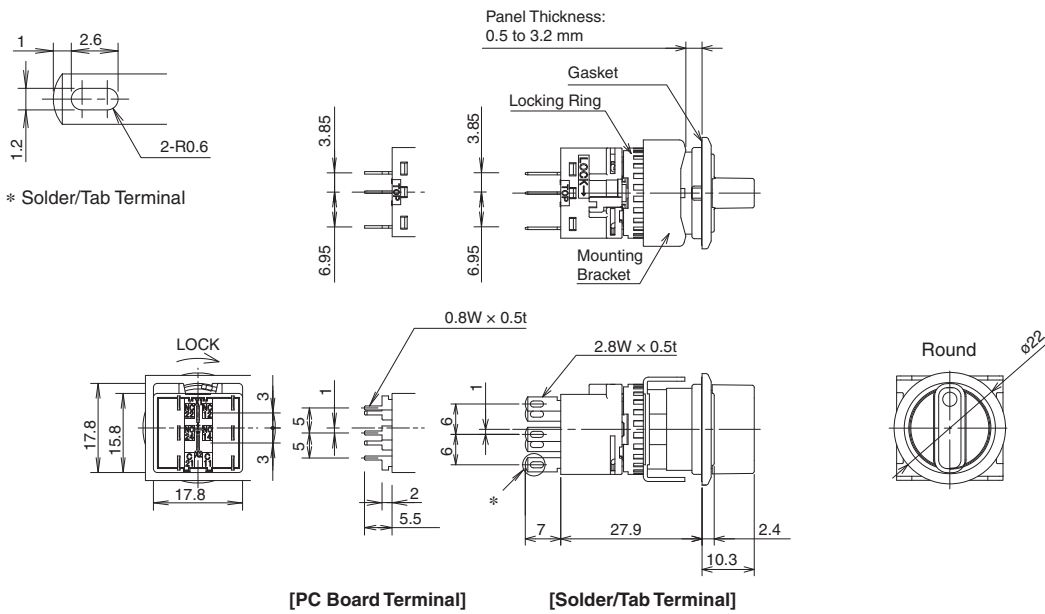

Terminal Arrangement (Bottom View)

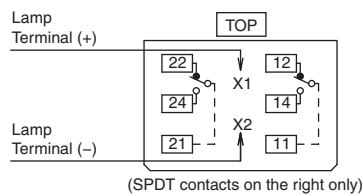

800.262.4332

www.IDEC.com/switches

Key Selector Switches

Standard Bezels

With Wave Key

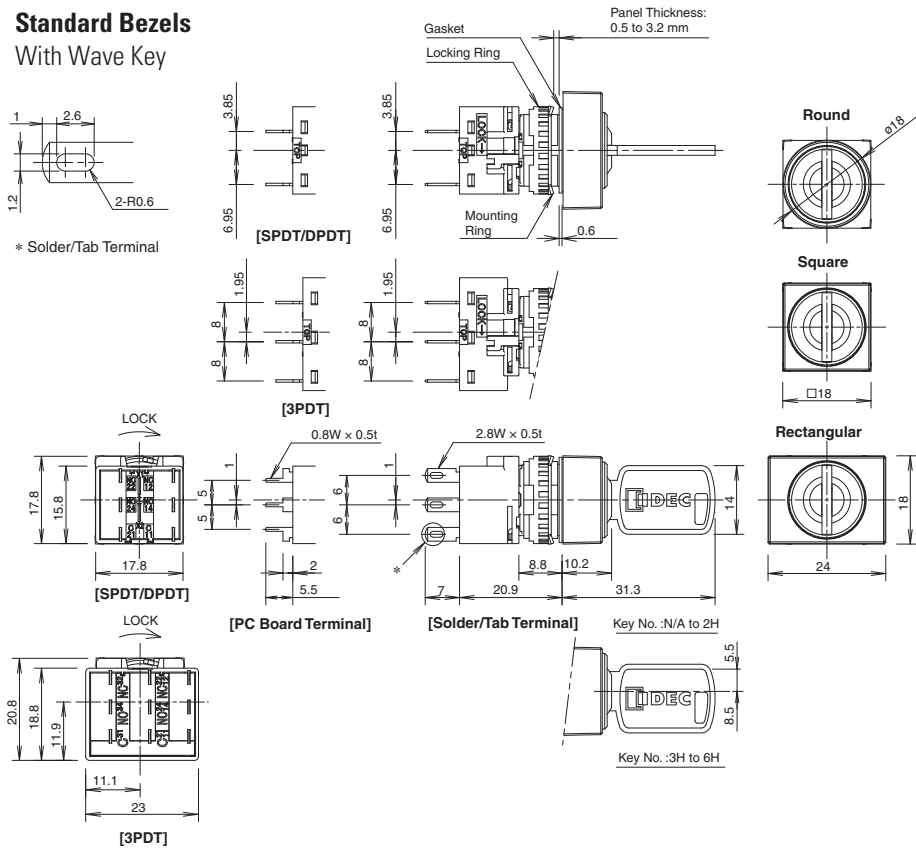

With Standard Key

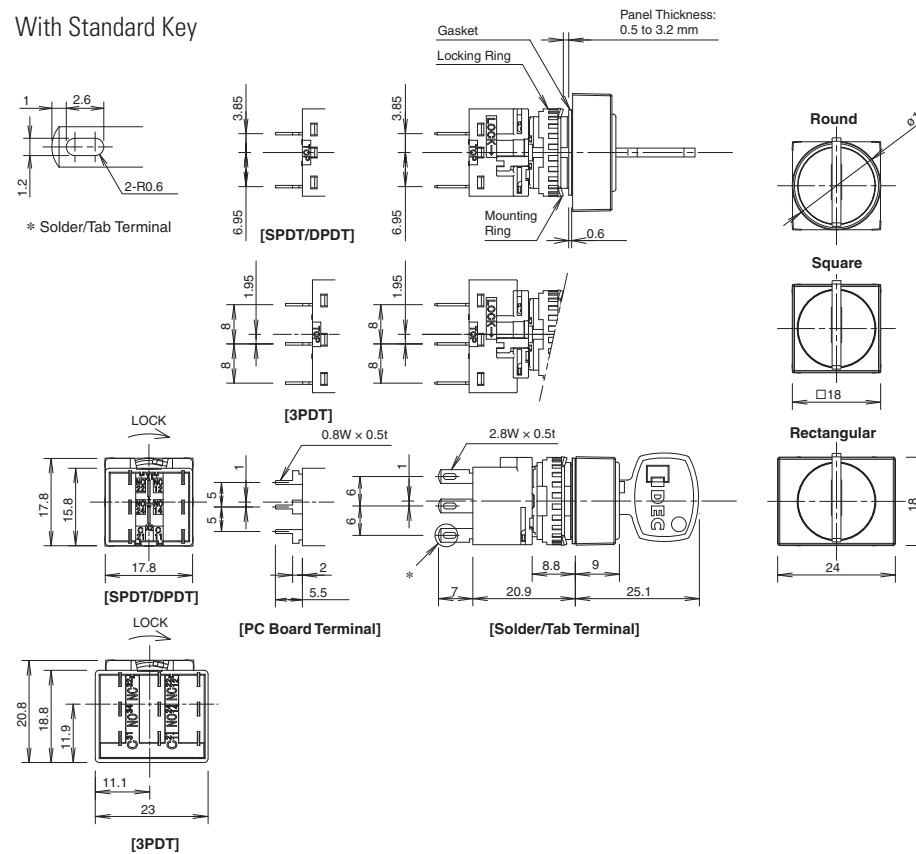

Dimensions (mm)

Key Selector Switches

Flush Bezels

With Wave Key

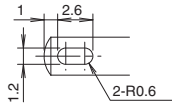

* Solder/Tab Terminal

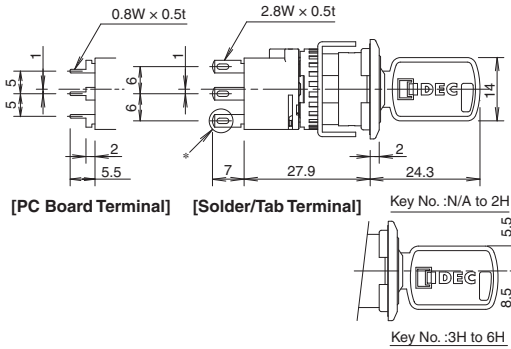
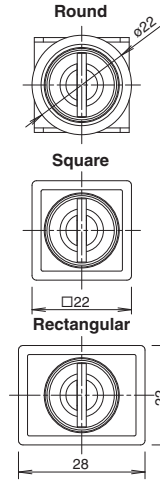
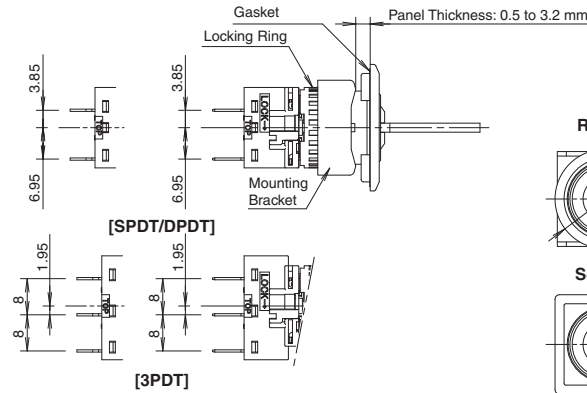
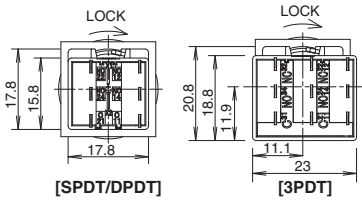

With Standard Key

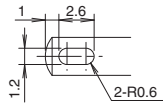

* Solder/Tab Terminal

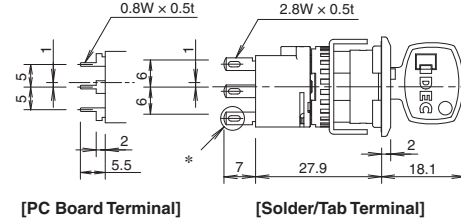
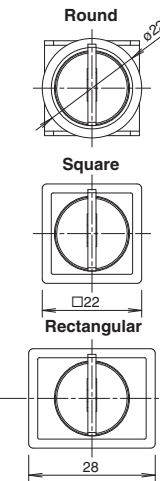
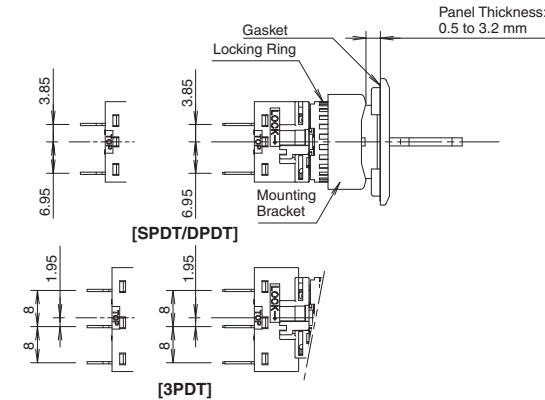
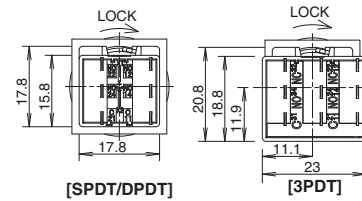

Terminal Arrangement (Bottom View)

SPDT/DPDT Contacts

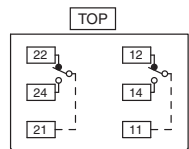

(SPDT contacts on the right only)

3PDT Contacts

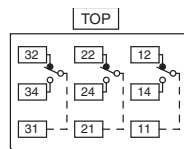

800.262.4332

www.IDEC.com/switches

Lever Switches

Standard Bezels

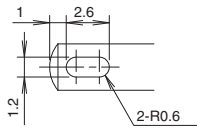

* Solder/Tab Terminal

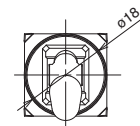
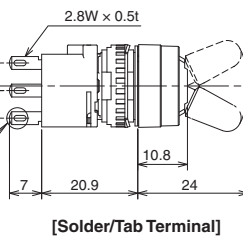
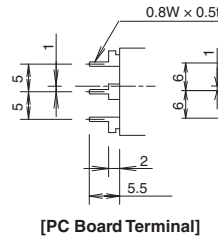
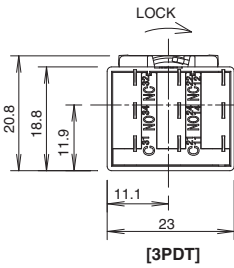
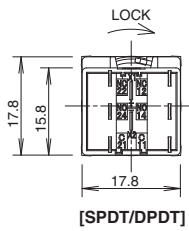
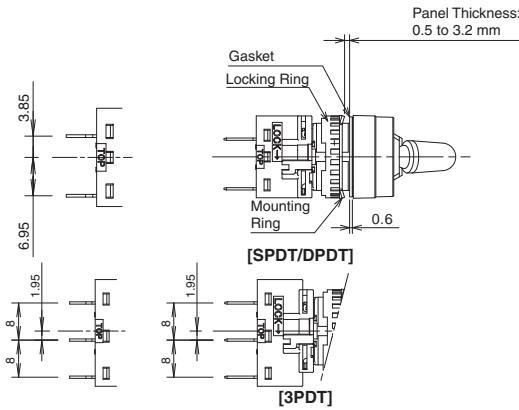

Flush Bezels

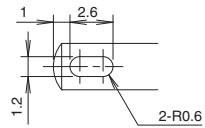

* Solder/Tab Terminal

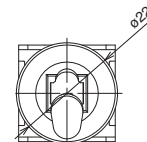
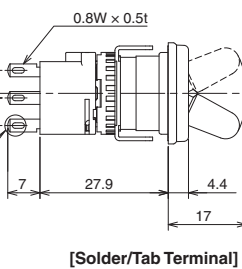
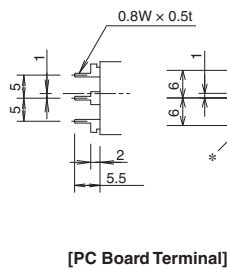
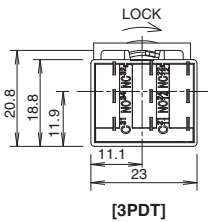
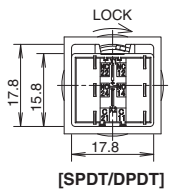
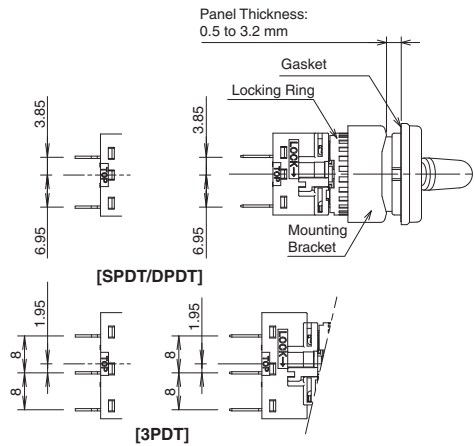

Terminal Arrangement (Bottom View)

SPDT/DPDT Contacts

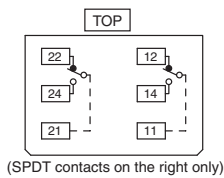

(SPDT contacts on the right only)

3PDT Contacts

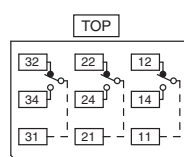

Dimensions (mm)

Buzzers

Standard Bezels

IP54

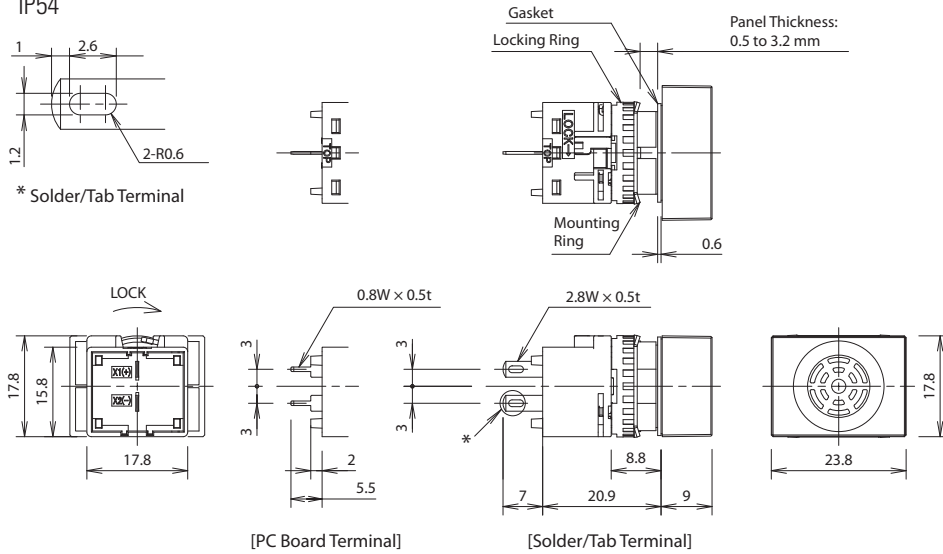

IP40

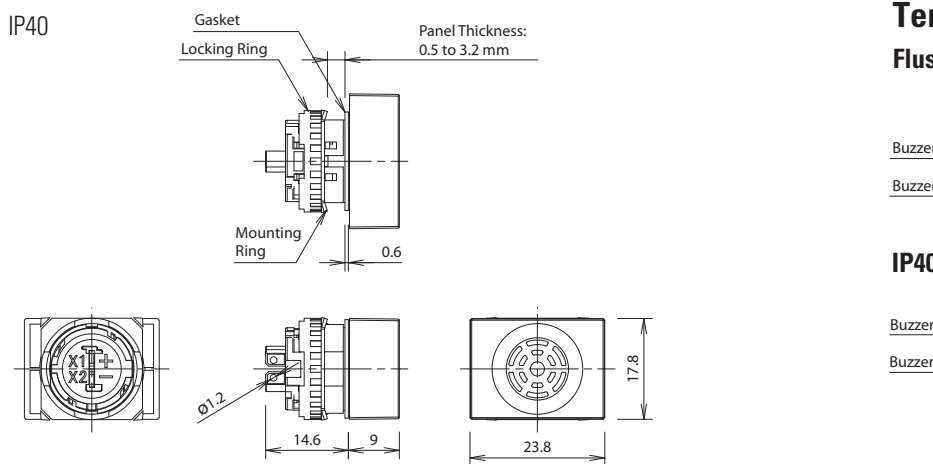

Terminal Arrangement (Bottom View)

Flush & Standard IP54



IP40

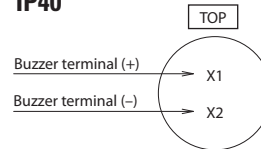

Flush Bezels

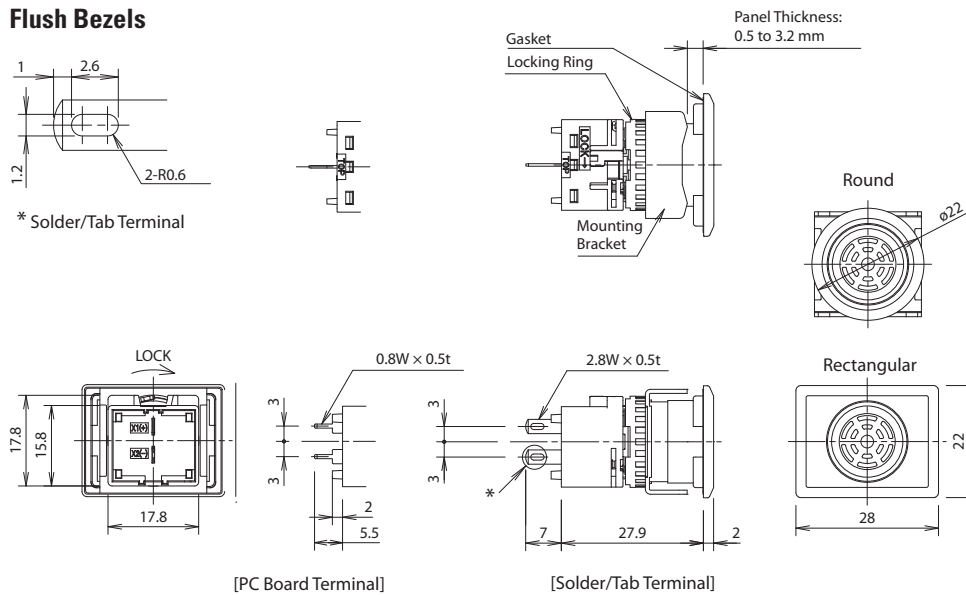

800.262.4332









www.IDEC.com/switches

Accessories

Item	Material	Part Number	Remarks	
Locking Ring Wrench 	Metal: Nickel-plated brass	MT-001	Used to tighten the locking ring when installing the units on to the panel.	
Lens Removal Tool 	Stainless Steel	MT-101	Used to remove the lens or button.	
Switch Guard (180° Spring return) 	For round / square standard units	Guard: Polyacetal	Degree of protection: IP65 Used to protect standard pushbuttons and illuminated pushbuttons from inadvertent operation. See page 38 for dimensions. With the gasket mounted on the switch, attach the switch guard and mount on the panel. Note: not applicable for flush mounted units. Select operator with built-in switch guard.	
	For rectangular standard units	Base: Polyarylate		AL-KH6SP
Switch Guard for Single Board Mounting 	For rectangular units	Guard: Polyacetal Base: Polyarylate	Degree of protection: IP65 With the gasket mounted on the switch, attach the switch guard and mount on the panel. See page 38 for dimensions.	
Rubber Boot for Standard Bezels 1  2  3 	1. For round units	Silicon Rubber	Degree of protection: IP65 See page 37 for dimensions. See page 42 for mounting.	
	2. For square units			LB9Z-D2
	3. For rectangular units			LB9Z-D3
Mounting Hole Plug 	Metal	Plug: Metal (Zinc diecast) Locking nut: Polyacetal Gasket: Nitrile rubber	Degree of protection: IP65 Tightening torque: 0.1 to 0.29 N•m See page 37 for dimensions.	
Mounting Hole Plug 	Rubber	Nitrile rubber (black)	Degree of protection: IP65 See page 37 for dimensions.	

Accessories con't on next page.

Accessories

Item	Material	Part Number	Remarks
Rubber Boot for Flush Bezels 1  2  3 	Silicon Rubber	1. For round units LB9Z-D6	Degree of protection: IP65 See page 37 for dimensions. See page 42 for mounting.
		2. For square units LB9Z-D7	
		3. For rectangular units LB9Z-D8	
For Flush Bezels Mounting Hole Plug 1  2  3 	Plug: Polyamide (Black) Gasket: Nitrile rubber Mounting Plate: Stainless Steel	1. For round units LB9Z-BS6	Degree of protection: IP65 Panel thickness: 0.5 to 3.2mm See page 37 for dimensions.
		2. For square units LB9Z-BS7	
		3. For rectangular units LB9Z-BS8	
Terminal Cover 1  2 	1. For SPDT/DPDT contacts LB9Z-VL2	See page 38 for dimensions.	
	2. For 3PDT contacts LB9Z-VL3		

800.262.4332

www.IDEC.com/switches

Accessory Dimensions (mm)

Rubber Boot

Standard Bezel

For round units (LB9Z-D1)

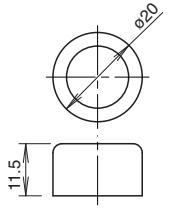

For square units (LB9Z-D2)

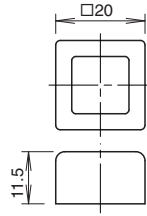

For rectangular units (LB9Z-D3)

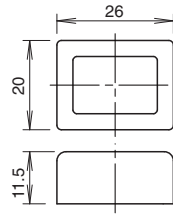

Flush Bezel

For round units (LB9Z-D6)

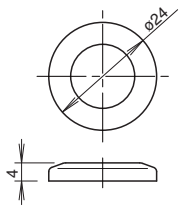

For square units (LB9Z-D7)

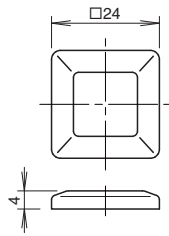

For rectangular units (LB9Z-D8)

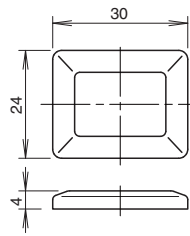

Mounting Hole Plug

Standard Bezels

AL-B6

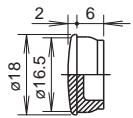

AL-BM6

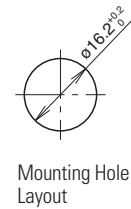
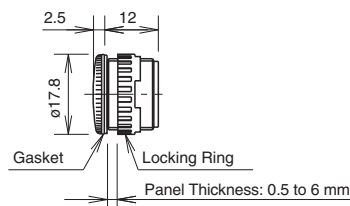

Flush Bezels

For round units (LB9Z-BS6)

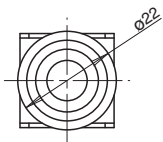

Mounting Hole Layout

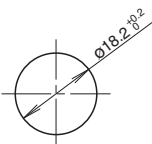

For square units (LB9Z-BS7)

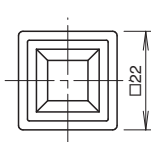

Mounting Hole Layout

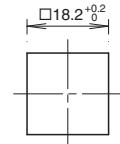

For rectangular units (LB9Z-BS8)

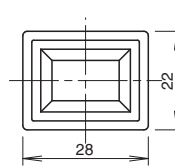

Mounting Hole Layout

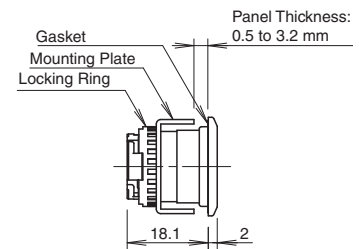
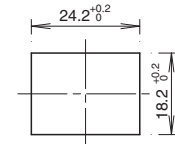

Accessory Dimensions (mm) con't

Terminal Cover

Standard Bezel

For SPDT/DPDT contacts (LB9Z-VL2)

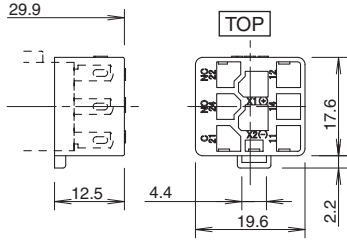

For 3PDT contacts (LB9Z-VL3)

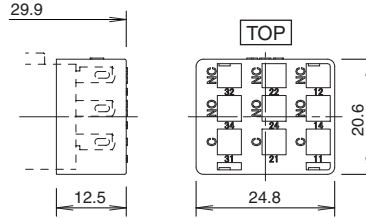

Switch Guard for Standard Bezel Models

For round / square units (AL-K6SP)

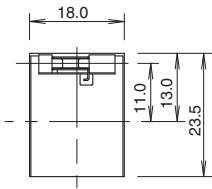

For rectangular units (AL-KH6SP)

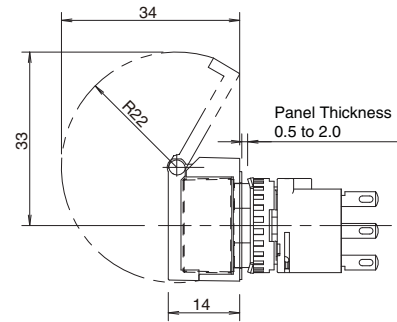
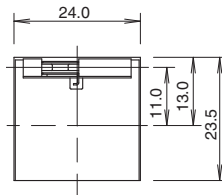

For Single Board Mounting (LA9Z-K3)

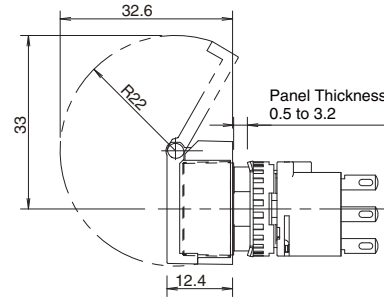
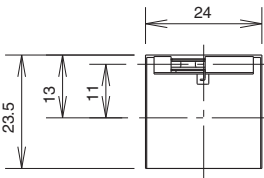

Note: The panel depth is the same for switches with or without switch guards. Both models can be installed on the same PC board.

Standard Key

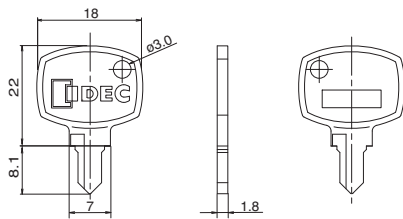

Wave Key

Reversible Wave Key

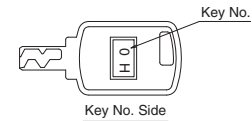
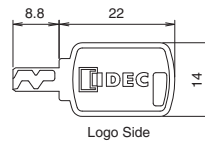

Non-reversible Wave Key

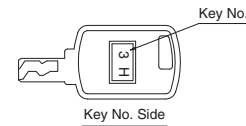
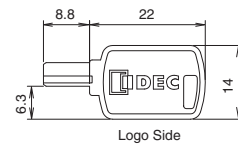

800.262.4332

www.IDEC.com/switches

Replacement Parts

Item		Material	Part Number	Remarks
	For round units	Polyarylate ø15.4 H4mm	AL6M-L [Ⓢ]	Specify the color code in place of [Ⓢ] in the part number. A: Amber, C: Clear, G: Green, R: Red, S: Blue, Y: Yellow Note: Use a clear lens for or white (PW) illumination.
	For square units	Polyarylate □15.4, H4mm	AL6Q-L [Ⓢ]	
	For rectangular units	Polyarylate W21.4 x H4 x D15.4mm	AL6H-L [Ⓢ]	
	For round units	Polyarylate □15.4, H4mm	AB6M-B [Ⓢ]	Specify the color code in place of [Ⓢ] in the part number. B: Black, G: Green, R: Red, S: Blue W: White, Y: Yellow
	For square units	Polyarylate □15.4, H4mm	AB6Q-B [Ⓢ]	
	For rectangular units	Polyarylate W21.4 x H4 x D15.4	AB6H-B [Ⓢ]	
	For round units	Acrylic ø13.7 H0.8	AL6M- [Ⓢ]	Specify the color code in place of [Ⓢ] in the part number. B: Black, W: White See page 41 for dimensions and engraving area.
	For square units	Acrylic □13.7, H0.8mm	AL6Q- [Ⓢ]	
	For rectangular units	Acrylic W19.7 x H0.8 (0.4) x D13.7mm	AL6H- [Ⓢ]	
	For all units	Polyamide ø17.9, H3.9mm	LB9Z-LNP	
	For standard bezel	Metal (Stainless steel) □17.9, t0.6mm	LB9Z-LP1	
	For flush bezel	Metal (Stainless steel) W21 x H8.2 x D20.6 t0.8mm	LB9Z-LP6	
	For key selector switches	Nickel-plated Brass	AS6-SK	See page 38 for dimensions.
 	For Wave key selector switches	Diecast zinc alloy (nickel plated) W14 x H2 x D30.8mm	LA9Z-SK- [Ⓢ]	Specify Wave key number in place of [Ⓢ] in the part number. 0H: Standard wave key (reversible) 1H to 2H: Reversible wave key 3H to 6H: Non-reversible wave key See page 38 for dimensions.

LB Series Replacement LED Unit

Item	Rated Operating Voltage	Part Number	ⓈColor Code	
	DC5V	LB9Z-LED5 [Ⓢ]	A G PW R S	1. Specify color code in place of the [Ⓢ] in the part number. R: Red, G: Green, A: Amber, S: Blue, PW: White 2. All illuminated LB series contain an LED unit. 3. Use a white (PW) LED unit for yellow (Y) illumination.
	AC/DC12V	LB9Z-LED1 [Ⓢ]		
	AC/DC24V	LB9Z-LED2 [Ⓢ]		

Precautions & Instructions

⚠ Safety Precautions

- Turn off the power to the LB series control units before installation, removal, wiring, maintenance, and inspection. Failure to turn power off may cause electrical shocks or fire hazard.
- To avoid burning your hand, use the lamp holder tool when replacing the lamps.
- For wiring, use wires of a proper size to meet voltage and current requirements. Solder correctly according to the instructions in "Wiring" and "Notes on Terminal Cover." Improper soldering may cause overheating and create a fire hazard. Also, when using tab terminals, use receptacles of appropriate size.

Instructions

Wiring

1. Solder the terminals at 350°C within 3 seconds using a 60W soldering iron. Sn-Ag-Cu type is recommended. When soldering, do not touch the LB series with the soldering iron. Also ensure that no tensile force is applied to the terminals. Do not bend the terminal or apply excessive force to the terminal.
2. Use non-corrosive liquid flux.

Terminal Cover

Solder/tab terminal

Insert the terminal cover into the contact block with the TOP markings on the contact block and the terminal cover in the same direction.

Note: When wiring, insert the lead wires into the terminal cover holes before soldering. After wiring, terminal covers cannot be installed.

Standard Bezel



Flush Bezel

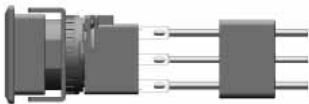

Operating Environment

- Do not use the LB series where corrosive gases exist or under an environment exceeding the operating temperature and humidity ranges. Otherwise, damage such as contact failure or change of the surface color may occur.
- Major parts of the switch are plastic. Scratches or damage may occur when scraped with a sharp object or if excessive load or shock is applied. Note that this may cause operation and appearance failure of the operator and bezel.
- Application of detergent, cutting oil, or special chemicals to the switch may result in operation and/or appearance failure such as a change in surface color.

Handling

Contacts (micro switch)

When using NC (normally closed) and NO (normally open) contacts of the same microswitch, avoid connections of different voltages, or connections of different types of power supplies. Failure to observe this instruction may cause a short-circuit.

Removing and Installing the Contact Block

1. Turn the locking lever on the contact block in the direction opposite to the arrow on the housing. Then the contact block can be removed.
2. Insert the contact block with the TOP markings on the contact block and the operator placed in the same direction. Then lock the units, turning the locking lever in the direction of the arrow.

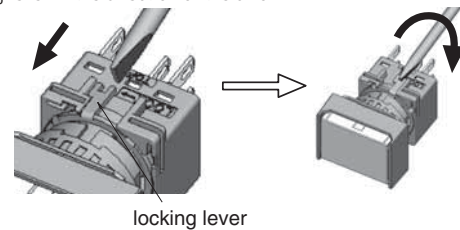

Panel Mounting

Remove the contact block from the operator. Insert the operator into the panel cut-out from the front, then install the contact block to the operator.

Standard Bezel

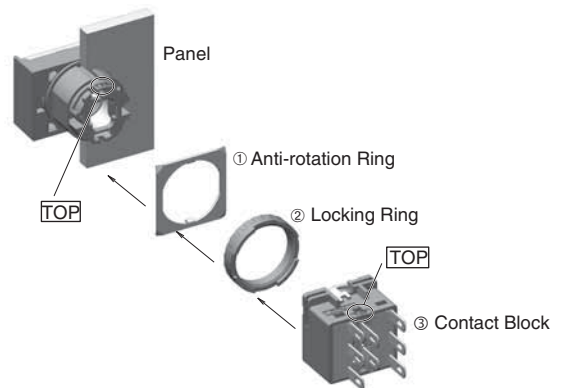

Flush Bezel

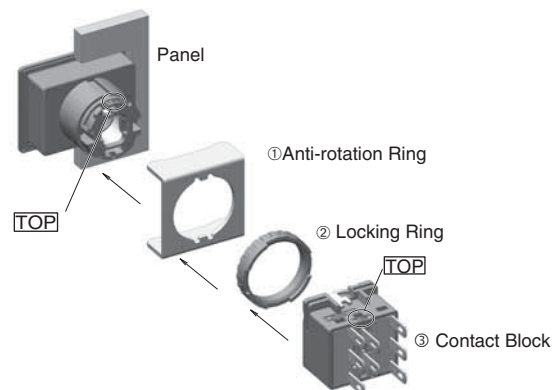

Notes on Mounting

Use the optional ring wrench (MT-001) to mount the operator onto the panel. Tightening torque should not exceed 0.7 N·m. Do not use pliers. Excessive tightening will damage the locking ring.

800.262.4332

www.IDEC.com/switches

Replacing the Lens

Standard Bezel

From the opposite side of the TOP marking, remove the operator (lens, marking plate, and lens holder) using the optional lens removal tool (MT-101) by gripping the recesses of the color lens. Removing from the TOP side may damage the metallic bezel.

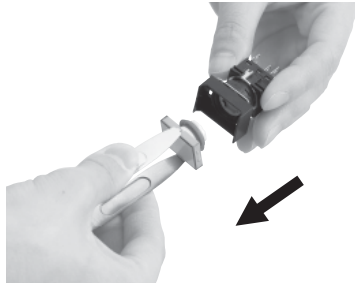

Removing the Operator (standard bezel)

Flush Bezel

From the opposite side of the TOP marking, push the tip of a flat screwdriver to the groove of the color lens and pull out the operator (lens, marking plate, lens holder). Removing from the TOP side may damage the metallic bezel.



Removing the Operator (flush bezel)

Replacing the Marking Plate

1. Remove the marking plate by pushing the lens from the back to disengage the latches between the lens and holder, using the screwdriver as shown below.

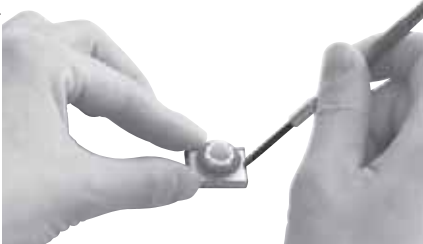

Note: A transparent film inside the lens holder is attached to the unit to make it waterproof and cannot be removed.

2. Insert a marking plate into the color lens, and press the lens onto the lens holder to engage the latches. Pay attention to the orientation of the marking plate.

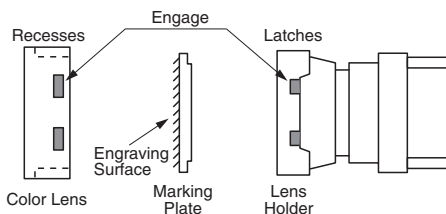

Lens Unit and Contact Block Installation

To insert the lens unit into the operator, press in the lens unit by aligning the latch on the operator with the latch on the lens unit.

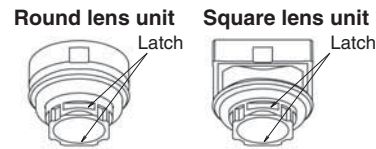

Standard Bezel

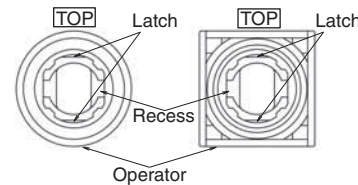

Flush Bezel

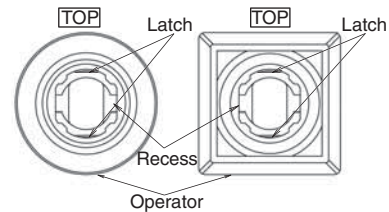

Marking Plates and Films

Illuminated pushbuttons and pushbuttons with illuminated lens can have legends and symbols engraved on the marking plates, or printed film can be inserted under the lens for labelling purposes.

Marking Plate and Marking Film Size

Lens	Round	Square	Rectangular
Built-in Marking Plate			
	<ul style="list-style-type: none"> Engraving must be made within the engraving area (0.5mm from edge). The marking plate is made of white acrylic resin. 		
Applicable Marking Film			
	<ul style="list-style-type: none"> Film thickness: 0.1mm per film Marking film is not included. Recommended marking film: Polyester film 		

Marking Plate and Film Insertion Order

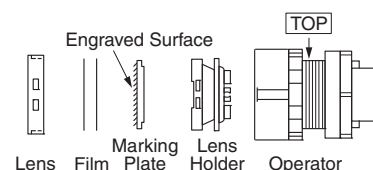

The marking plate must be engraved on the side specified above. Pay attention to the orientation of the marking plate.

Instructions

Replacing the LED Unit

The LED unit can be replaced by pulling the lens unit out of the contact block.

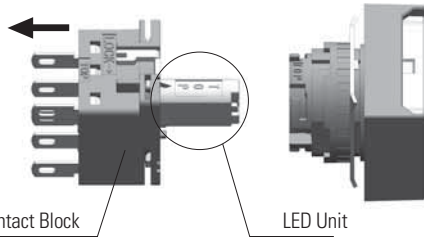

Orientation of the LED unit

Insert the LED unit into the contact block with the TOP markings on the contact block and LED unit in the same orientation.

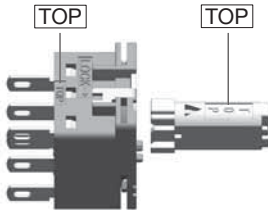

Notes on replacing the LED Unit

- When replacing the LED unit, make sure that static electricity is not applied.
- Make sure that the LB series has cooled down before replacing the LED unit.
- To avoid getting burned, be careful not to touch the unit while it is still hot.

Notes on Using Quick Connect Terminals

1. Use #110 tab quick connects, 0.5mm-thick.
2. When connecting the terminals on the left and center, make sure that surfaces of the quick connects face each other. Otherwise, a short-circuit may occur.

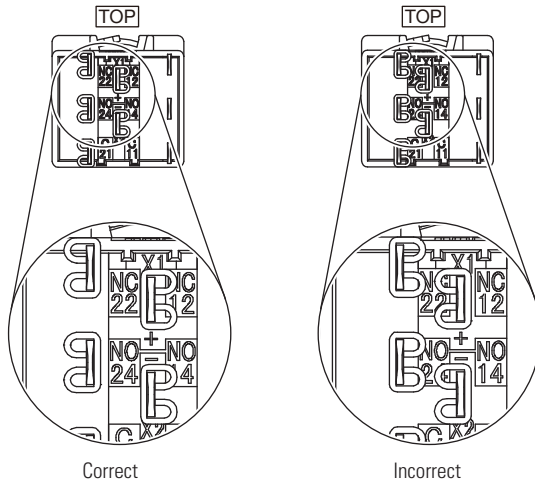

3. Apply only horizontal force against the panel to the tab. The switch may be damaged if a force other than a horizontal force is applied.

Installing Rubber Boots

When using the switches in environments subject to splashing water or an excessive amount of dust, make sure to use an optional rubber boot. As shown in the drawing on the right, ① remove the gasket from the operator, and ② attach the rubber boot from the front (button side).

Standard Bezels

For rectangular and square units, pull the seals out of the rubber boot and place them around the operator sleeve as shown below. Make sure that the seals are not twisted or tucked inside and that the gasket is removed, otherwise waterproof and dustproof characteristics are not ensured.

How to Install the Rubber Boot

Rectangular

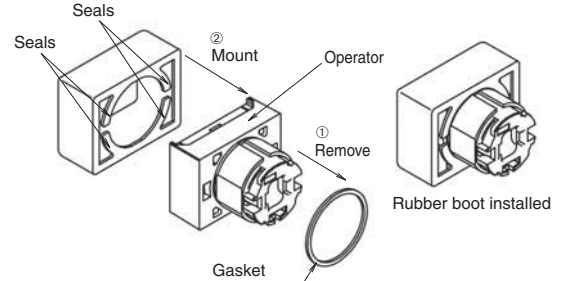

Square

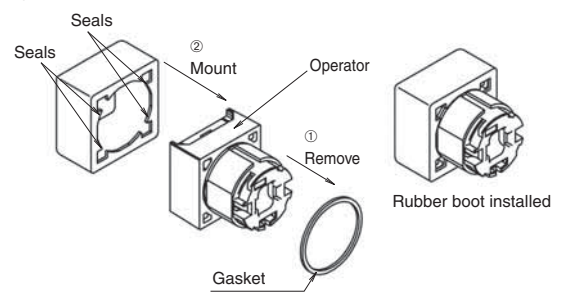

Round

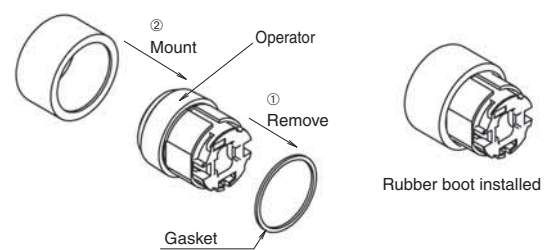

Flush Bezels

Mount the rubber boot so that the protrusion at the bottom surface of the operator fits with the recess on the operator, placing the rubber boot all around the operator sleeve. Make sure that the protrusion on the rubber boot and the recess on the operator fit correctly, otherwise, the waterproof and dustproof characteristics are not ensured.

How to Install the Rubber Boot

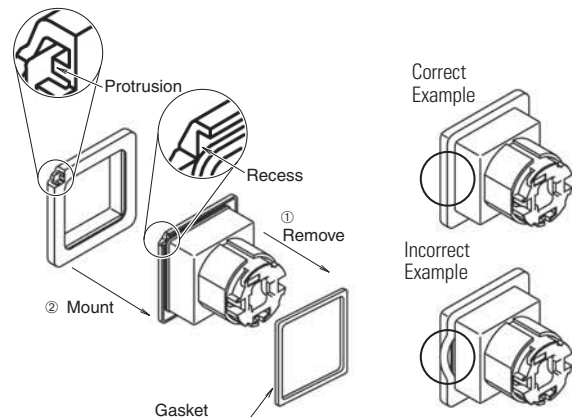

Note: Install the rubber boot before mounting the unit to the panel.

Maintained Pushbuttons

Do not replace the buttons when the pushbutton is in the maintained position as it may damage the internal mechanism. Also, do not remove the contact block with the button in the maintained position. The contact may not operate properly when the contact block is remounted.

Pushbuttons and Illuminated Pushbuttons with Switch Guard

Do not apply force to the switch guard when the switch guard is not attached to a panel. When opening the switch guard, do not open more than 180°. The hinge may break.

Selector Switches

When turning the operator or key, make sure that they are turned to the correct position.

Selector Switches with Key

Observe the following instructions to prevent malfunction or damage.

- Do not remove the key from any key retained position.
- In addition to the standard key (key number 0H), six other key numbers are available. Use a key matching the number of the key cylinder. The standard key does not have a key number indication.
- Keys are available in two types.
Key numbers 0H (standard), 1H, and 2H are reversible keys which can be inserted in two ways.
Key numbers 3H, 4H, 5H, and 6H are non-reversible keys. Make sure of correct insertion direction.

Single Board Mounting

The LB series can be used for single board mounting.

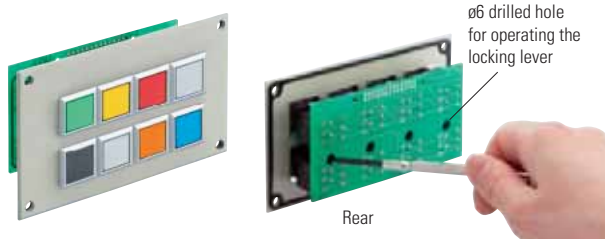

Installing and Removing Contact Blocks

Turn the locking lever to install and remove contact blocks on a PC board using a screwdriver from a hole in the PC board. Determine the location of the switches so that the locking lever can be operated.

Mounting Holes and Assembly Procedure

Drill mounting holes in the panel as shown on the right. When the units are mounted together, provide adequate clearance.

Panel Cut-out

Standard Bezels (LB1/LB2/LB3/LB4)

SPDT/DPDT Contacts

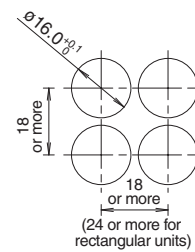

3PDT Contacts

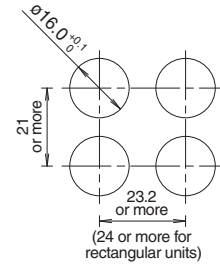

Flush Bezels

SPDT/DPDT Contacts

LB6/LB6M

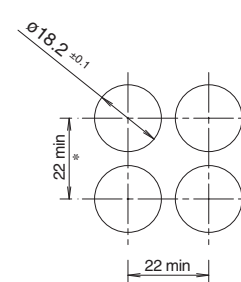

3PDT Contacts

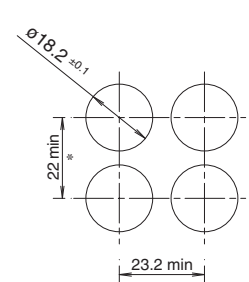

LB7/LB7M

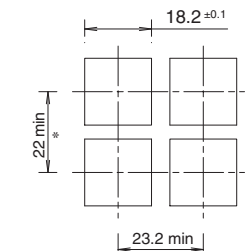
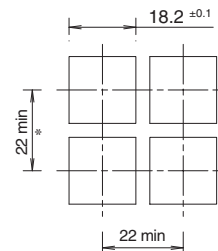

LB8/LB8M

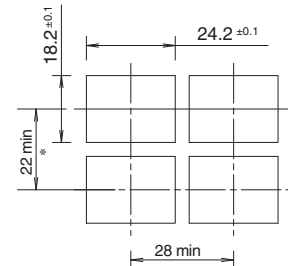
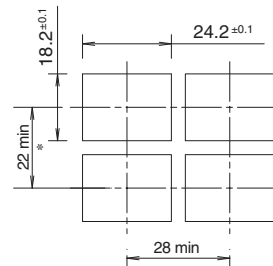

* 45mm minimum for switches with guard

All dimensions in mm.

Assembly Procedure

1. Install the operator to the panel.
2. Mount the contact block to the operator from the back of the panel.
3. Turn the locking lever to lock the contact block.
4. Insert a PC board and solder.

Notes:

1. Make sure that each terminal is inserted into the PC board correctly.
2. Do not apply tensile force to the connector cable for an extended period of time.
3. Do not expose the contact block to water.
4. Ensure that the contact blocks are locked when installed on the operators.

800.262.4332

www.IDEC.com/switches

16mm LB Miniature Switches

With both flush and standard mount options, LB switches offer sleek lines and vivid colors to enhance the look of your application while also increasing its marketable value. The flush mount switches are perfect for applications requiring a smooth, hygienic surface, and this essential component will add style and an updated look to any application. Take a closer look and see which LB switch is for you!



Projects only
2mm from
the panel.

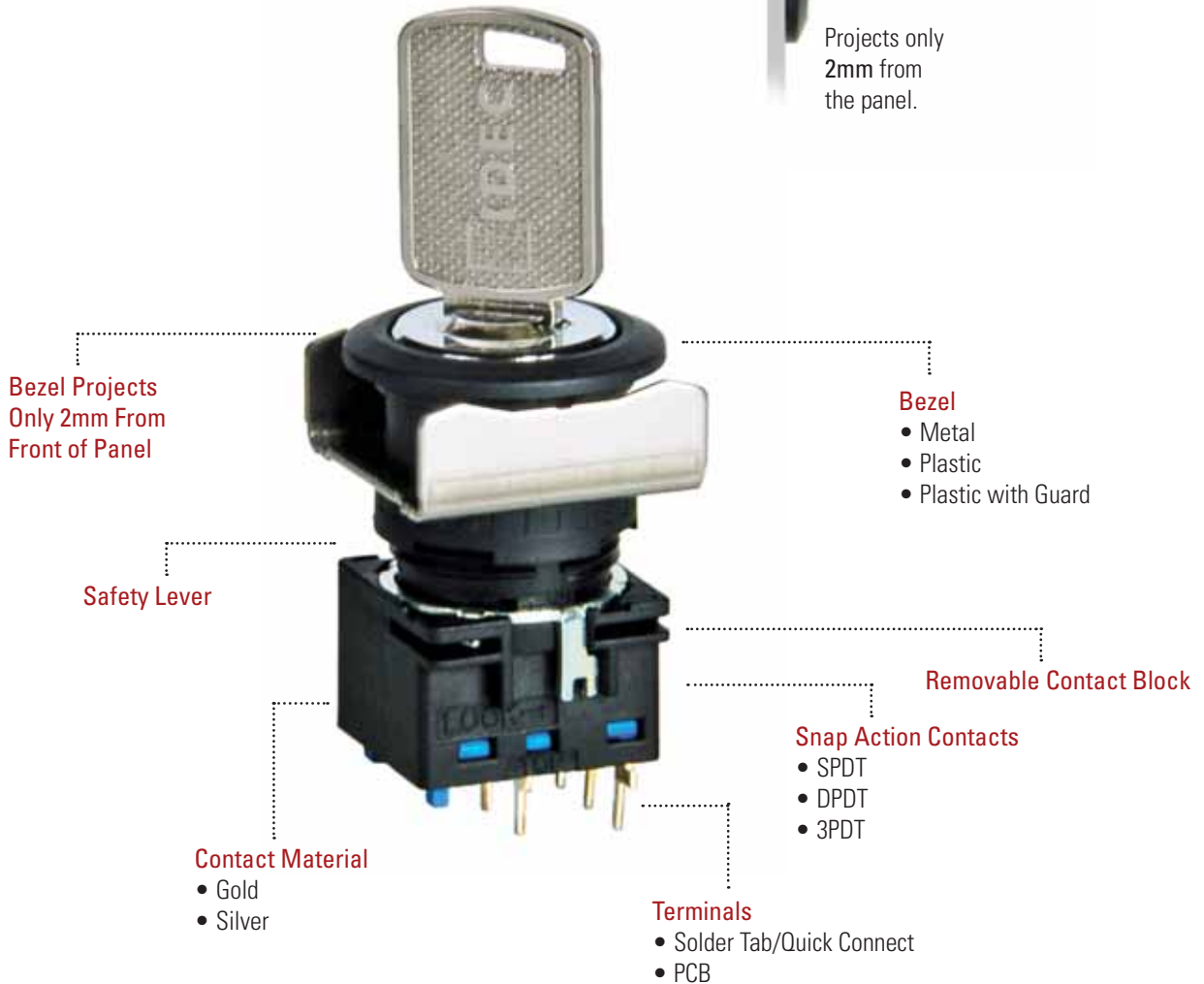

Think Automation and beyond...

www.IDEC.com/switches

www.IDEC.com

USA

IDEC Corporation
Tel: (408) 747-0550
opencontact@IDEC.com

Canada

IDEC Canada Ltd.
Tel: (905) 890-8561
sales@ca.IDEC.com

Australia

IDEC Australia Pty. Ltd.
Tel: +61-3-8523-5900
sales@au.IDEC.com

Japan

IDEC Corporation
Tel: +81-6-6398-2571
marketing@IDEC.co.jp

United Kingdom

IDEC Electronics Ltd.
Tel: +44-1256-321000
sales@uk.IDEC.com

Germany

IDEC Elektrotechnik GmbH
Tel: +49-40-253054-0
service@IDEC.de

Hong Kong

IDEC (H.K.) Co., Ltd.
Tel: +852-2803-8989
info@hk.IDEC.com

China/Beijing

IDEC (Beijing) Corporation
Tel: +86-10-6581-6131

China/Shanghai

IDEC (Shanghai) Corporation
Tel: +86-21-6135-1515
idec@cn.IDEC.com

China/Shenzhen

IDEC (Shenzhen) Corporation
Tel: +86-755-8356-2977

Singapore

IDEC Asia Pte. Ltd.
Tel: +65-6746-1155
info@sg.IDEC.com

Taiwan

IDEC Taiwan Corporation
Tel: +886-2-2698-3929
service@tw.IDEC.com

©2013 IDEC Corporation. All Rights Reserved. LB9Y-B100-0 03/13 7.5K

Specifications and other descriptions in this catalog are subject to change without notice.

X-ON Electronics

Largest Supplier of Electrical and Electronic Components

Click to view similar products for [Switch Accessories](#) category:

Click to view products by [Idec](#) manufacturer:

Other Similar products are found below :

[896809000](#) [01500](#) [01010](#) [01501](#) [7101MD9V30B](#) [7103KZBE](#) [7103P3YAVGE](#) [7209MD9ABE](#) [7209SY9AQE](#) [7209SYCBE](#) [7303KZQE](#)
[F1302](#) [F1403](#) [760201000](#) [764300000](#) [785105000](#) [785106000](#) [789009000](#) [7T0062](#) [7T0073](#) [MJ1216](#) [MJ33](#) [MJ612](#) [849PT01A](#)
[91321314655637182-1-MEV](#) [A0107X](#) [A0141A](#) [A0141E](#) [A0142M2SP](#) [A0142M5](#) [A0142N5](#) [A0143G](#) [A0143H](#) [A0161G](#) [A0162A](#) [A0162F](#)
[A019307](#) [A01RTC8](#) [A0214X](#) [A0215X](#) [A02504](#) [A02512](#) [A0261A](#) [A0263D](#) [A029303](#) [A02MXB](#) [A168P1](#) [A274](#) [A3A-7310](#) [A3PA571124E](#)