

**LF1D and LF2D**  
Machine Tools • Food and Beverage Processing Equipment • Vision Systems

**LF1D (IP67, IP69K) and LF2D (IP67, IP67F) Series**

With their rugged construction, the LF1D/2D series of light units are ideal for machine tools, automated label and package inspection equipment, and food and beverage processing equipment. Their design provides equally brilliant light at the center or edges of the units. Plus with their ratings, the LF1D (IP67, IP67F, IP69K) and LF2D (IP67, IP67F) can be used where high-pressure and high-temperature washdowns are used.

**Mini (LF1D-C)**

- Compact unit only 100 x 50 x 25mm
- Single LED module design eliminates multiple shadows while distributing light over a wide area (120°)

**Slim and Wide (LF1D/2D-EH, FH)**

- Brightness: 1450lx at 1m
- Available with terminal block or spring clamp connections for easy installation
- Angle adjustable mounting brackets provide installation flexibility

**Long (LF1D-H/J)**

- Two lengths available: 365mm and 510mm
- The flat light design reduces glare and multiple shadows, improving visibility from a distance
- M12 Quick Disconnect option (Pig Tail)



**LED Optical Specifications**

Model	Mini	Slim	Wide	Long	
	LF1D-C	LF1D/2D-EH	LF1D/2D-FH	LF1D-H	LF1D-J
Illumination Color	Cool White			Neutral White	
Total Luminous Flux	560lm	1000lm	1260lm	2000lm	3000lm
Color Temperature	5700K			4700K	
Reference Illuminance at 1.0m	180lx	1450lx	1200lx	560lx	840lx

LED modules and illumination units may vary in color and brilliance. Luminous flux, color temperature, and illuminance values shown are typical.

**General Specifications**

Model	Mini	Slim	Wide	Long	
	LF1D-C	LF1D/2D-EH	LF1D/2D-FH	LF1D-H	LF1D-J
Rated Voltage	24V DC				
Voltage Range	21.6 to 26.4V DC				
Rated Power (typ.)	4.6W	11W	12.5W	18.4W	27.6W
Insulation Resistance	100MΩ minimum (500V DC megger)				
Dielectric Strength	1000V AC, 50/60Hz, 1 minute				
Vibration Resistance (damage limits)	Frequency 5 to 55Hz, amplitude 0.5mm				
Shock Resistance (damage limits)	1000m/s <sup>2</sup>				
Operating Temperature	-30 to +55°C (no freezing)				
Operating Humidity	45 to 85% RH (no condensation)				
Storage Temperature	-35 to +70°C (no freezing)				
Operating Environment	No corrosive gases				
Life <sup>1</sup>	50,000 hours (The illumination duration in which the illuminance maintains a minimum of 70% of the initial value at 25°C.)				
Degree of Protection <sup>2</sup>	IP67F (reinforced glass), IP67 (all models), IP69K (LF1D)				
Material <sup>3</sup>	Housing: Diecast aluminum (LF1D/LF2D), Lens: Reinforced glass or polycarbonate (LF1D/LF2D) Cover: Stainless steel (LF1D), Flange cover: Diecast aluminum (LF2D)				
Weight (approx.)	420g	LF1D-EH-2W*: 750g LF1D-EH-2W-A*: 950g LF2D-EH-2W*: 850g LF2D-EH-2W-A*: 1,000g	LF1D-FH-2W*: 800g LF1D-FH-2W-A*: 1,000g LF2D-FH-2W*: 900g LF2D-FH-2W-A*: 1,050g	1200g	1600g

1. LED life depends on the operating environment.

2. Waterproof or oil-proof characteristics specified by IEC 60529 and JIS0920. For illumination units without accessories, use a cable gland and cables that satisfy IP67F or IP67 degree of protection.

3. The reinforced glass and polycarbonate lens types have the same appearance, but have different degrees of protection (IP67F or IP67).

Part Numbers

Mini (LF1D-C)

Cable		
Location	Length	Part Number



Side	3m	LF1D-C2F-2W-330
	5m	LF1D-C2F-2W-350
Back	3m	LF1D-C2F-2W-430
	5m	LF1D-C2F-2W-450

Long (LF1D-H 365mm)

Cable		
Location	Length	Part Number



Side	5m	LF1D-H2F-2N-350
	1.5m + M12 connector	LF1D-H2F-2N-3B0
Back	5m	LF1D-H2F-2N-450
	1.5m + M12 connector	LF1D-H2F-2N-4B0

Long (LF1D-J 510mm)

Cable		
Location	Length	Part Number



Side	5m	LF1D-J2F-2N-350
	1.5m + M12 connector	LF1D-J2F-2N-3B0
Back	5m	LF1D-J2F-2N-450
	1.5m + M12 connector	LF1D-J2F-2N-4B0

Slim and Wide Surface Mounting (LF1D-EH, FH)

Model			Slim Model (10 LEDs x 1 row)		Wide Model (7 LEDs x 2 rows)	
Cable Gland LF9Z-A11	Cable LF9Z-C05	Mounting Bracket LF9Z-B11,B12	Clear Reinforced Glass	Clear Polycarbonate	Clear Reinforced Glass	Clear Polycarbonate
— (hole on the side)	—	√	LF1D-EH2F-2W LF1D-EH2F-2W-101	LF1D-EH3G-2W LF1D-EH3G-2W-101	LF1D-FH2F-2W LF1D-FH2F-2W-101	LF1D-FH3G-2W LF1D-FH3G-2W-101
— (hole on the back)	—	√	LF1D-EH2F-2W-200 LF1D-EH2F-2W-201	LF1D-EH3G-2W-200 LF1D-EH3G-2W-201	LF1D-FH2F-2W-200 LF1D-FH2F-2W-201	LF1D-FH3G-2W-200 LF1D-FH3G-2W-201
√ (Side)	—	√	LF1D-EH2F-2W-300 LF1D-EH2F-2W-301	LF1D-EH3G-2W-300 LF1D-EH3G-2W-301	LF1D-FH2F-2W-300 LF1D-FH2F-2W-301	LF1D-FH3G-2W-300 LF1D-FH3G-2W-301
	√	√	LF1D-EH2F-2W-350 LF1D-EH2F-2W-A	LF1D-EH3G-2W-350 LF1D-EH3G-2W-A	LF1D-FH2F-2W-350 LF1D-FH2F-2W-A	LF1D-FH3G-2W-350 LF1D-FH3G-2W-A
√ (Back)	—	√	LF1D-EH2F-2W-400 LF1D-EH2F-2W-401	LF1D-EH3G-2W-400 LF1D-EH3G-2W-401	LF1D-FH2F-2W-400 LF1D-FH2F-2W-401	LF1D-FH3G-2W-400 LF1D-FH3G-2W-401
	√	√	LF1D-EH2F-2W-450 LF1D-EH2F-2W-451	LF1D-EH3G-2W-450 LF1D-EH3G-2W-451	LF1D-FH2F-2W-450 LF1D-FH2F-2W-451	LF1D-FH3G-2W-450 LF1D-FH3G-2W-451

Slim and Wide Recessed Mounting (LF2D-EH, FH)

Model		Slim Model (10 LEDs x 1 row)		Wide Model (7 LEDs x 2 rows)	
Cable Gland LF9Z-A11	Cable LF9Z-C05	Clear Reinforced Glass	Clear Polycarbonate	Clear Reinforced Glass	Clear Polycarbonate
—	—	LF2D-EH2F-2W	LF2D-EH3G-2W	LF2D-FH2F-2W	LF2D-FH3G-2W
—	—	LF2D-EH2F-2W-200	LF2D-EH3G-2W-200	LF2D-FH2F-2W-200	LF2D-FH3G-2W-200
√ (Side)	—	LF2D-EH2F-2W-300	LF2D-EH3G-2W-300	LF2D-FH2F-2W-300	LF2D-FH3G-2W-300
	√	LF2D-EH2F-2W-A	LF2D-EH3G-2W-A	LF2D-FH2F-2W-A	LF2D-FH3G-2W-A
√ (Back)	—	LF2D-EH2F-2W-400	LF2D-EH3G-2W-400	LF2D-FH2F-2W-400	LF2D-FH3G-2W-400
	√	LF2D-EH2F-2W-450	LF2D-EH3G-2W-450	LF2D-FH2F-2W-450	LF2D-FH3G-2W-450

Accessories



Item	Mounting Bracket				Cable Gland	Cable
	Fixed		Adjustable Angle			
Part Number	LF9Z-B11	LF9Z-B12	LF9Z-1MDE1	LF9Z-1MDF1	LF9Z-A11	LF9Z-C05
Applicable Unit	LF1D (Slim)	LF1D (Wide)	LF1D (Slim)	LF1D (Wide)	LF1D/2D (Slim and Wide)	
Material	Stainless Steel				Brass	PVC
Notes	1 pair, Left and Right				M8*	Length: 5m

\*Applicable wire size (10-12 AWG)

**Part Number Structure** (use for interpreting part numbers only)

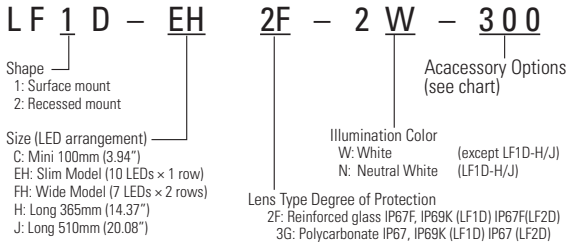

**Terminal Block Wiring**

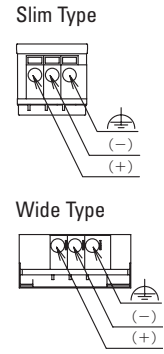

Applicable ferrules: 0.25 to 0.75 mm<sup>2</sup>  
Recommended source - Phoenix Contact:  
AI 0,25-12 BU, AI 0,34-12 TQ,  
AI 0,5-12 WH, AI 0,75-12 GY

1. Mounting bracket available for LF1D (wide and slim) only.
2. Only available for LF1D (wide and slim) models.
3. 1.5m cable with M12 connector for Long only (LF1D-H, J).

**Illuminance Charts**

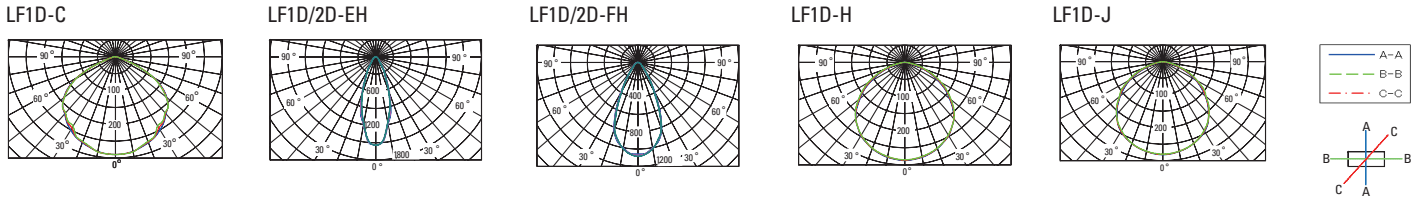

**Internal Circuits**

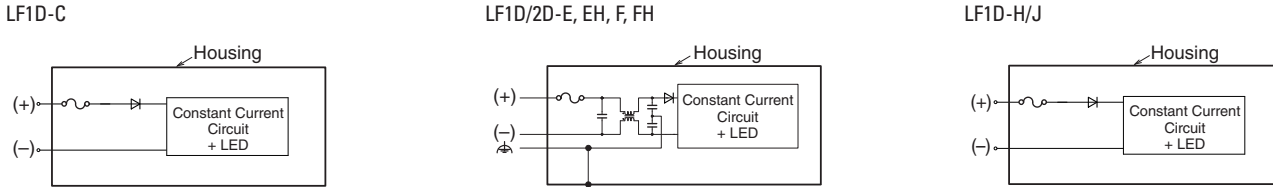

**Distribution Characteristics**

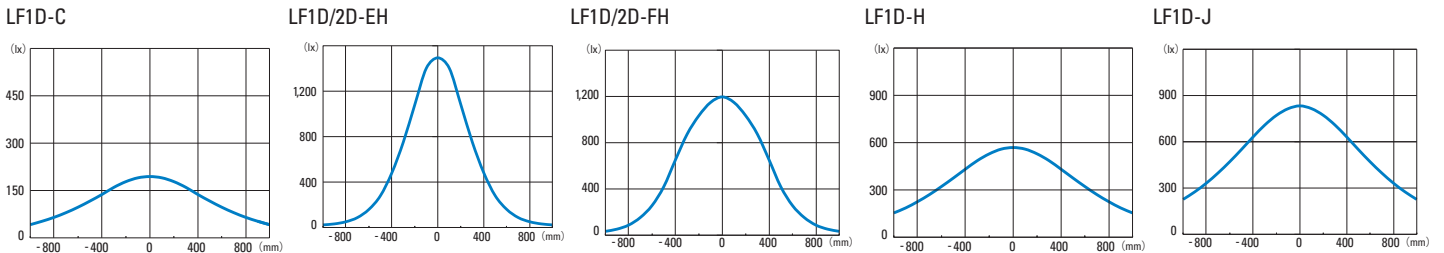

**Dimensions (mm)**

LF1D-C Mini

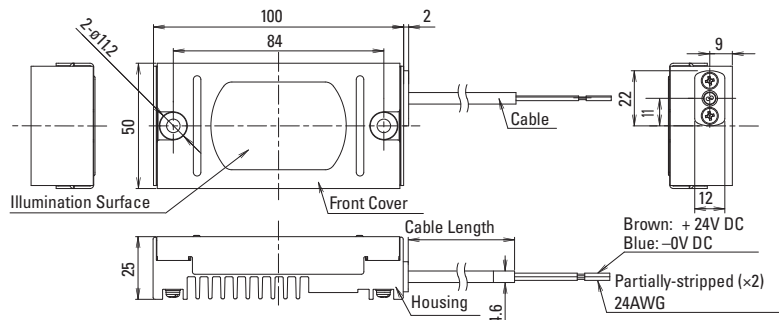

Note: When leading the cable from the cable gland on the back, provide a hole in the mounting plate. Also, provide a proper sealing.  
 Recommended M5 screw:  
 Screw head height: 9.5mm max.  
 Screw head diameter: 10mm max.  
 Screw length: 20mm min.  
 Recommended washer diameter: 10mm max.

Mounting Hole Layout

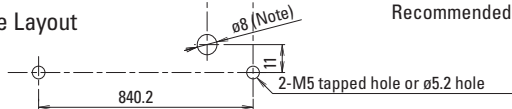

LF1D Slim

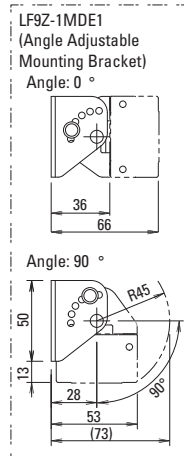
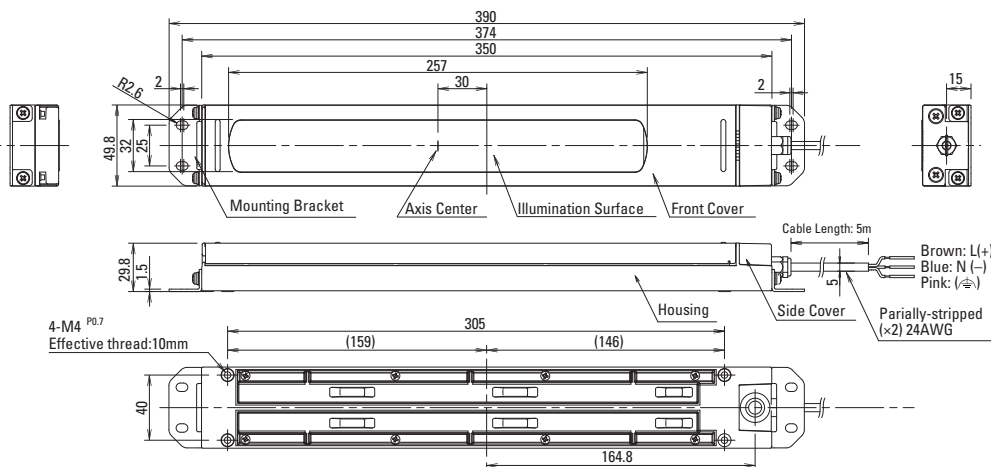

Mounting Hole Layout

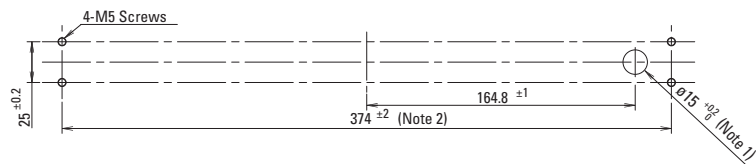

Note 1: When leading the cable from the cable gland on the back, provide a hole in the mounting plate.  
 Note 2: When using the adjustable mounting bracket, the tolerance is 374<sup>+0.2</sup> when the gasket diameter is larger than ø10 and ø12 or smaller

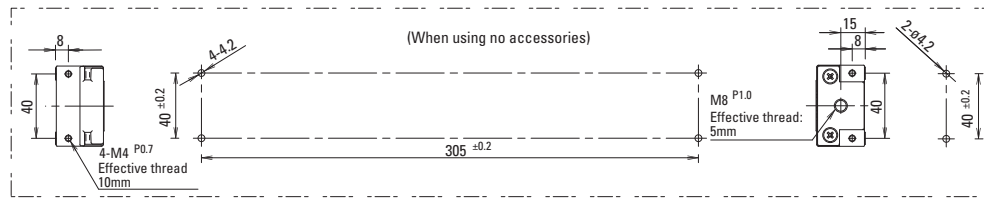

LF2D Slim

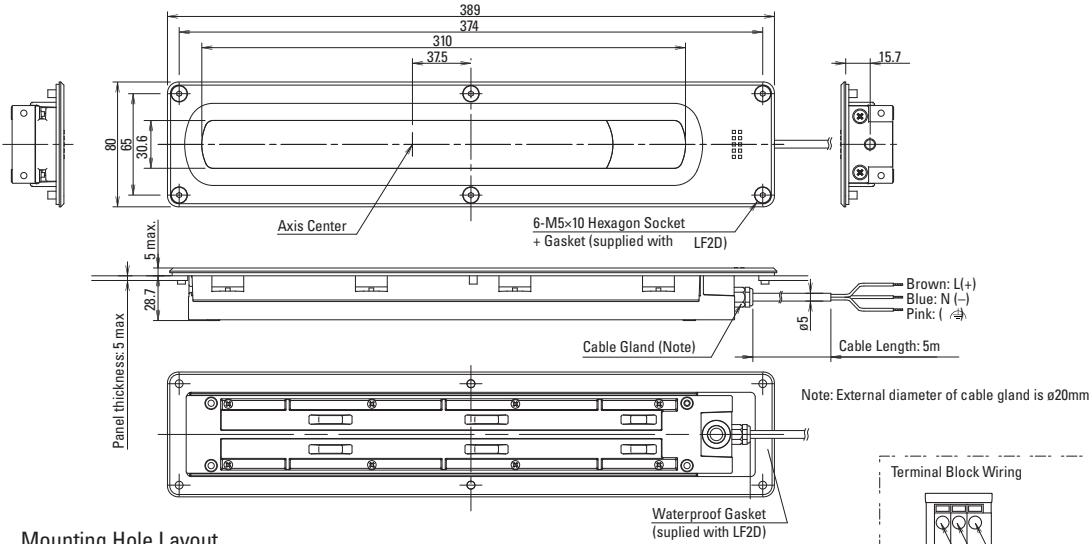

Mounting Hole Layout

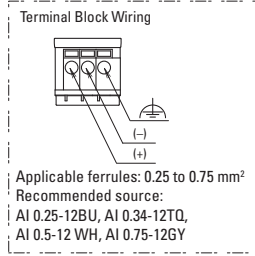
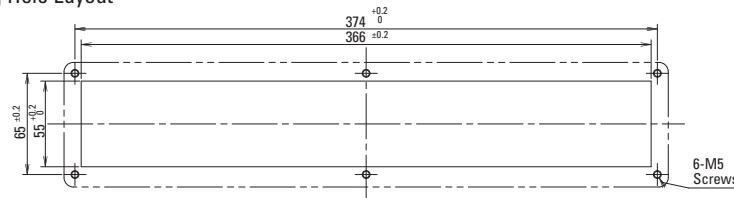

LF1D Wide

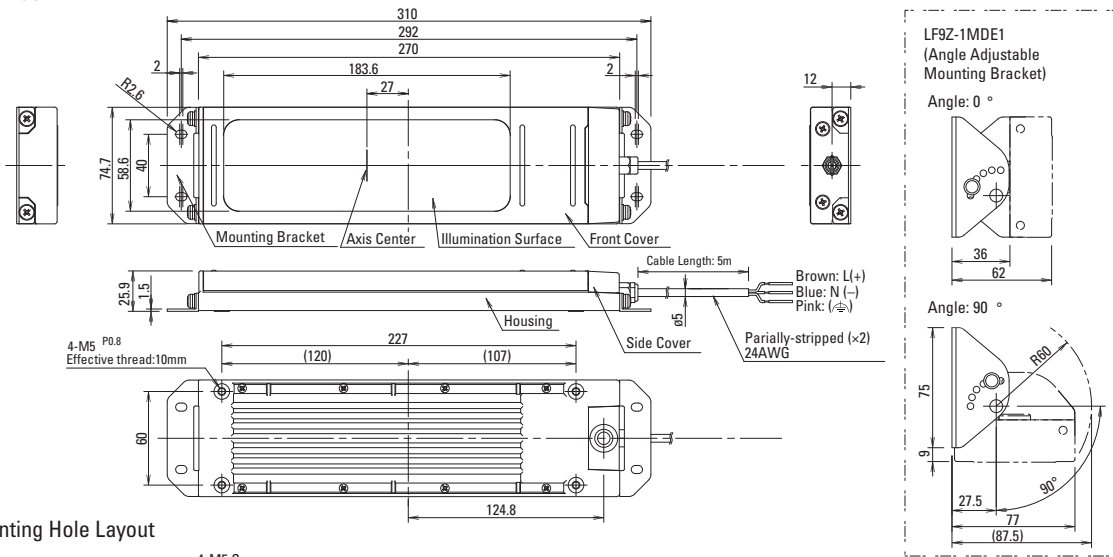

Mounting Hole Layout

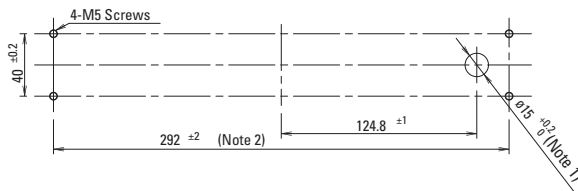

Note 1: When leading the cable from the cable gland on the back, provide a hole in the mounting plate.  
 Note 2: When using the angle adjustable mounting bracket, the tolerance is 374 ±0.2 when the gasket diameter is larger than ø10 and ø12 or smaller.

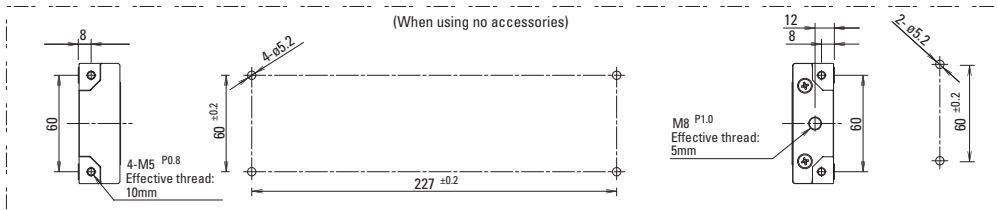

All dimensions in mm.

LF2D Wide

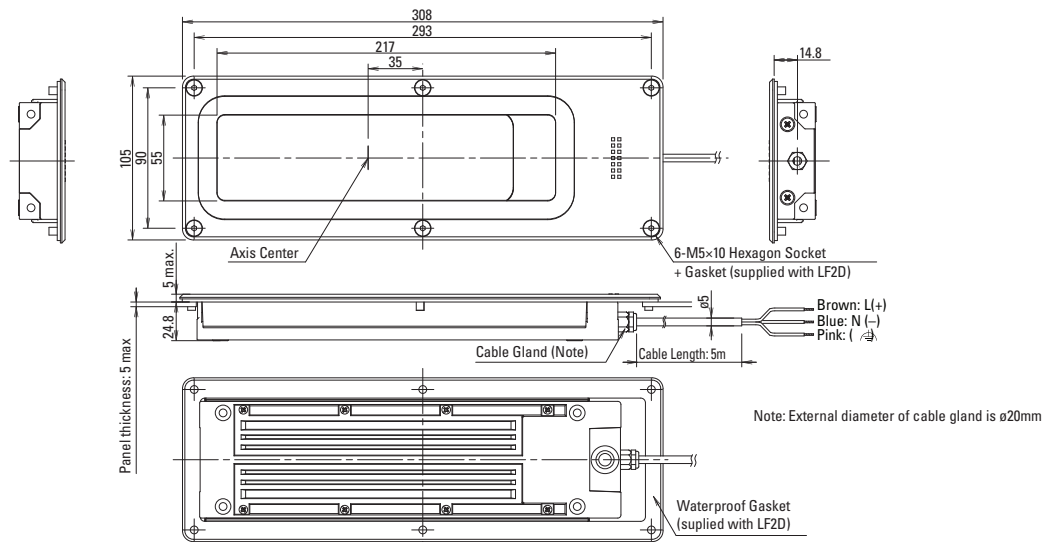

Mounting Hole Layout

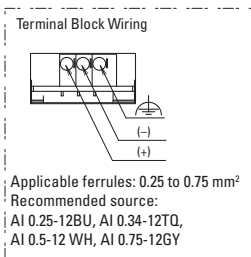
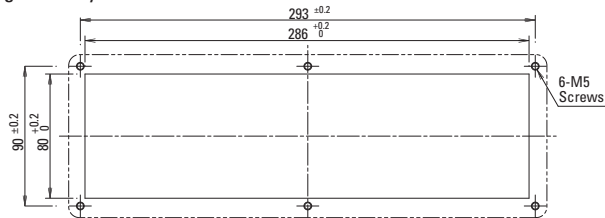

LF1D-H Long

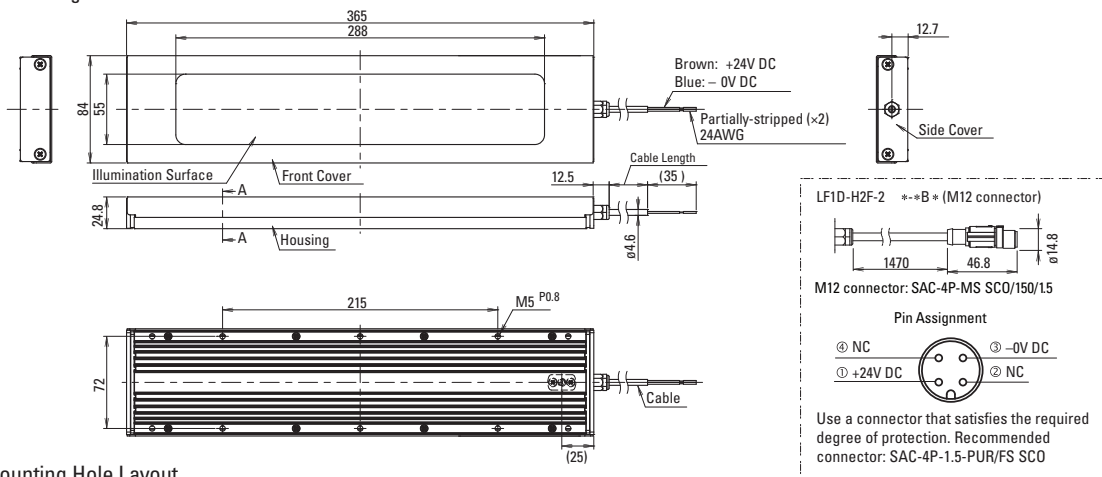

Mounting Hole Layout

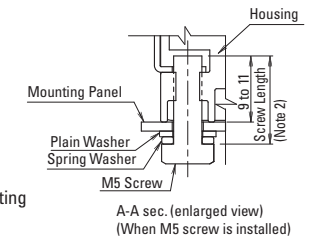
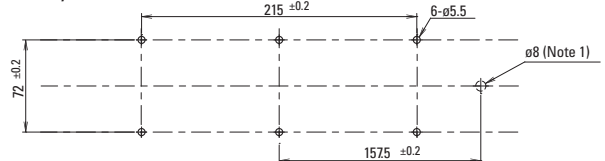

Note 1: When leading the cable from the cable gland on the back, provide a hole in the mounting plate. A ø16 hole is necessary when using the LF1D-\*2F -2N \*B\* (M12 connector type)

Note 2: Choose mounting screws in consideration of mounting plate thickness.

LF1D-J Long

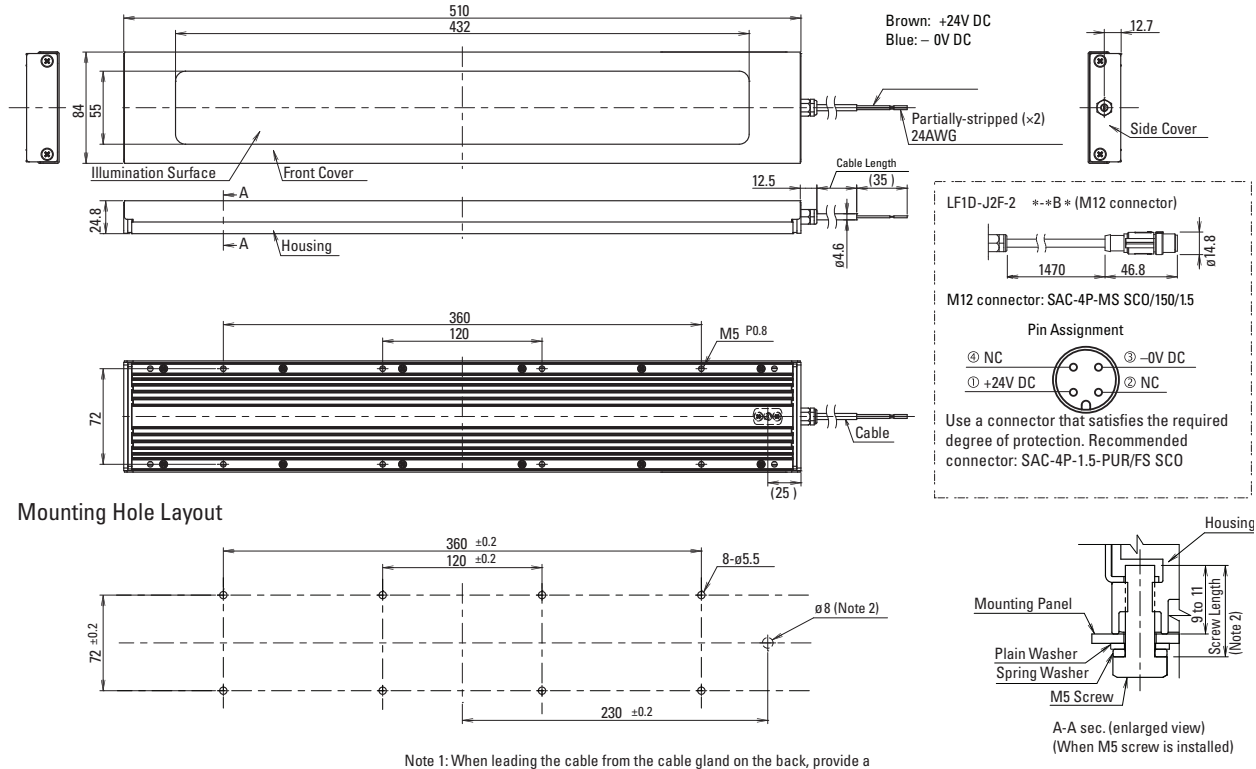

**Safety Precautions**

Do not disassemble, repair, or modify the LF1D/2D. Otherwise electric shock, fire, or malfunction may occur. Before wiring, confirm that the LF1D/2D has cooled down sufficiently. Ensure the correct operating temperature. Otherwise internal temperature rise may result in damage. LED illumination unit is general-purpose industrial electric device. Do not use for electronic equipment which may damage the human body or threaten life in case a malfunction or failure occurs.

**Instructions**

LED modules may vary in illumination colors and illuminance. Before designing equipment and powering up illumination units, confirm the specifications described in the instruction sheet. Apply voltage within the rated value, otherwise the LED elements may be damaged. Do not loosen screws, otherwise the protection characteristics will be impaired. Do not use or store in a place subjected to vibration and shock. Otherwise electric shock or failure occurs. To clean the cover, use a soft cloth with water or neutral detergent. Do not use solvents such as thinners, benzene, or alkaline, otherwise discoloration, deterioration, or decrease in strength may occur.

## X-ON Electronics

Largest Supplier of Electrical and Electronic Components

*Click to view similar products for [Idec manufacturer](#):*

Other Similar products are found below :

[LT7A-XE-G](#) [LT7A-XE-R](#) [LT7B-A250](#) [LT7B-A250FB](#) [LW6L-M1C24MG](#) [FB1T-000Z](#) [FB1W-HW1B-V411R-EMO-2](#) [FB1W-XW1E-BV411MR](#) [FB1W-XW1E-BV413MR](#) [FB3W-413Z](#) [FC2A-KP1C](#) [FC4A-J8AT1](#) [FC4A-T16S3](#) [FC5A-C16R2C](#) [MM-SMART-24](#) [MM-SMART-40](#) [FT1A-C12RA-S](#) [FT1A-C12RA-W](#) [FT1A-C14SA-B](#) [PF3S-BP12](#) [PS3X-D24AFG](#) [PS3X-Q12AFG](#) [GT3A-3AD24](#) [GT3F-2EAD24](#) [GT3S-2AF20](#) [GT3W-A16AD24](#) [GT3W-A33AF20N](#) [ABD302N-R](#) [ABD410N-R](#) [ABFD411N-G](#) [ABN4F11-G](#) [HE2B-M211PB](#) [HE2G-21SH](#) [HE9Z-D3B](#) [HG9Z-2A1](#) [HG9Z-XC300](#) [ACSNO-6123-FB-C6002](#) [RH3V2-UAC240V](#) [DFAN-031-B](#) [AL6M-LK1-G](#) [AL6M-P3-R](#) [AL6Q-M13-W](#) [AL6Q-M23P-QG](#) [ALFD29901DN-G-24V](#) [ALFN22211DNG-U](#) [ALFW224611D-W](#) [ALNE8811-G](#) [ALQW2B24611D-G](#) [ALW212611-G](#) [ALW22211DG](#)