

L6 (Oversize) Series — Miniature Switches and Pilot Devices

Key features:

- 5/8" (16mm) mounting holes
- Locking lever removable contact blocks
- Solder terminal or PCB terminal options
- Available assembled or as sub-components
- Worldwide approvals
- Incandescent or LED illumination
- Snap action contacts



UL Recognized  
File No. E55996



CSA Certified  
File No. LR21451



Registration No. R9551089 (E-stops)  
Registration No. J9551458 (all other switches)  
Registration No. R95650511 (Pilot Lights)



Contact Ratings	Conforming to Standards	EN60947-1, EN60947-5-1, VDE0660-200, UL508, CSA C22-2 NO.14						
	Operating Temperature	Operation: -25 to +55°C (without freezing), 45 to 85% RH Storage: -30 to +80°C (without freezing)						
	Vibration Resistance	5 to 55Hz, 1.0 peak-peak amplitude max						
	Shock Resistance	Operating limit: 100 m/sec <sup>2</sup> (approximately 10G) Damage limit: 1000 m/sec <sup>2</sup> (approximately 100G)						
	Mechanical Life	Momentary pushbuttons 2,000,000 operations minimum All others: 250,000 operations minimum						
	Degree of Protection	IP65 (conforming to IEC 60529)						
	Dielectric Strength	Switch unit: between live and ground: 2500 volt AC, 1 minute between terminals of different poles: 2500 volt AC, 1 minute between terminals of same pole: 1000 volt AC, 1 minute Illumination unit: between live part and ground: 2500 volt AC, 1 minute						
	Insulation Resistance	100MΩ minimum (using 500V DC megger)						
	Rated Insulation Voltage	250V AC/DC						
	Rated Thermal Current	Gold Contacts (pcb): 3A Silver Contacts (solder): 5A						
	Contact Resistance	50Ω maximum initial value						
	Rated Operating Current		Silver Contacts (Solder Terminals)				Gold Clad Contacts (PCB terminals)	
			30V	125V	250V		30V	125V
		AC resistive	—	5A	2A	AC inductive	-	0.1A
	AC inductive	—	2A	1.5A	DC resistive	0.1A	—	
	DC resistive	3A	0.4A	—				
	DC inductive	1A	0.2A	—				
	Minimum Recommended Load (reference value for silver contacts)	5V AC/DC, 1mA						
	Terminal Style	0.110" Solder Tab /PCB						
	Contact Form	Snap Action, Double Throw						
	Contact Material	Solder Tab: Pure Silver /PCB: Gold Plated Silver						
	Electrical Life (at full load)	Momentary pushbuttons: 100,000 operations minimum (1800 operations / hour) All others: 100,000 operations minimum (1200 operations / hour)						
Lamp Ratings	Lamp Current Draw	5V DC LED: 8mA 6V AC/DC LED: 7mA 12V AC/DC LED: 8mA 24V AC/DC LED: 8mA 120V AC = 8mA		6V AC/DC incandescent: 100 mA 12V AC/DC incandescent: 50 mA 24V AC/DC incandescent: 25 mA				
	Lamp Life	Incandescent: 2000 hours./LED 50,000 hours. (on pure DC, half-life intensity)						

Switches & Pilot Devices

Signaling Lights

Relays & Sockets

Timers

Contactors

Terminal Blocks

Circuit Breakers

**Built-in LED Lamp Ratings**

Model	LFTD-5②	LFTD-1②	LFTD-2②	LFTD-H2②
Lamp Base	SX6S/8x5.4			
Rated Voltage	5V DC	12V AC/DC	24V AC/DC	120V AC
Operating Voltage	5V DC ±5%	12V AC/DC ±10%	24V AC/DC ±10%	120V AC ±5%
Current Draw	AC	9mA	9mA	8mA
	DC	8mA	8mA	—
Color Code ②	Specify a color code in place of ② in the Part No: A (amber), G (green), R (red), S (blue), W (white), Y (yellow)			
Lamp Base Color	Same as illumination color			
Voltage Marking	Stamped on the lamp base			
Life (reference value)	Approx. 50,000 hours			
Internal Circuit	A, R, W, Y	A, R, W, Y		
	G, S	G, S		

**Non-Illuminated Pushbuttons (Assembled)**

**Non-Illuminated Pushbuttons**

Style	Operation	Contact	Terminal Style	
			Solder Tab	PCB
	Momentary	SPDT	HA1B-M2C5-①	HA1B-M2C1V-①
		DPDT	HA1B-M2C6-①	HA1B-M2C2V-①
	Maintained	SPDT	HA1B-A2C5-①	HA1B-A2C1V-①
		DPDT	HA1B-A2C6-①	HA1B-A2C2V-①
	Momentary	SPDT	HA2B-M1C5-①	HA2B-M1C1V-①
		DPDT	HA2B-M1C6-①	HA2B-M1C2V-①
	Maintained	SPDT	HA2B-A1C5-①	HA2B-A1C1V-①
		DPDT	HA2B-A1C6-①	HA2B-A1C2V-①
	Momentary	SPDT	HA2B-M2C5-①	HA2B-M2C1V-①
		DPDT	HA2B-M2C6-①	HA2B-M2C2V-①
	Maintained	SPDT	HA2B-A2C5-①	HA2B-A2C1V-①
		DPDT	HA2B-A2C6-①	HA2B-A2C2V-①
	Momentary	SPDT	HA1B-M3C5-①	HA1B-M3C1V-①
		DPDT	HA1B-M3C6-①	HA1B-M3C2V-①
	Maintained	SPDT	HA1B-A3C5-①	HA1B-A3C1V-①
		DPDT	HA1B-A3C6-①	HA1B-A3C2V-①

**① Button Color Codes**

Color	Code	Color	Code
Black	B	Blue	S
Green	G	White	W
Red	R	Yellow	Y

1. In place of ① specify Button Color Code from table.
2. Illuminated (translucent) style lenses also available, specify as such: instead of LA1B-M1C5-① use LA1B-M1C5L-② in place of ② (specify Lens Color Code from next page.)
3. PCB terminal models also available with silver contacts (change "1" or "2" to "5" or "6" respectively, ie LA1B-M1C1V-① becomes LA1B-M1C5V-①).

Non-Illuminated Pushbuttons (Sub-Assembled)

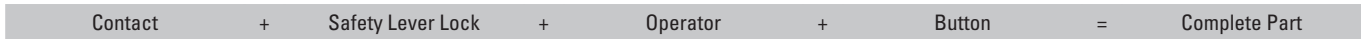





Operators



Style	Momentary	Maintained
Oversize Round 	HA1B-M0	HA1B-A0
Oversize Square 	HA2B-M0	HA2B-A0
Mushroom 	HA1B-M0L	HA1B-A0L

- 1. In place of ① specify Button Color Code from table on right.
- 2. In place of ② specify Lens Color Code from table on right.
- 3. \*requires HA1L-M0 or HA1L-A0 operator instead of HA1B-M0 or HA1B-A0.
- 4. \*\*requires HA2L-M0 or HA2L-A0 instead of HA2B-M0 or HA2B-A0.

Buttons/Lenses

Style	Button	Lens
Oversize Round Flush 	HA1A-B1-①	HA1A-L1-②*
Oversize Round Extended 	HA1A-B2-①	-
Oversize Square Flush 	HA2A-B1-①	HA2A-L1-②**
Oversize Square Extended 	HA2A-B2-①	-
Mushroom 	HA1A-B3-①	HA1A-L3-②

Contacts

Style	Contacts	Terminal Style	
		Solder Tab	PCB
	Gold SPDT DPDT	HA-C1	HA-C1V
		HA-C2	HA-C2V
	Silver SPDT DPDT	HA-C5	HA-C5V
		HA-C6	HA-C6V

Safety Lever Lock

Style	Part Number
	HA9Z-LS

① Button Color Code

Color	Code
Black	B
Green	G
Red	R
Blue	S
White	W
Yellow	Y

② Lens Color Code

Color	Code
Amber	A
Green	G
Red	R
Blue	S
Yellow	Y
White	W

### HA1B/HA1E Stop Switch

**Key features:**

- PCB or Solder Terminals
- Locking Lever Removable Contact Blocks
- Positive Action Contacts
- 1 or 2 form B (SPST-NC) Contacts
- IP65 Protection
- 16mm Mounting Hole
- Tamper Proof Construction



**Specifications**

Contact Form	1 or 2 form B (SPST-NC)	
Termination	PCB or Solder Terminal	
Contact Material	Silver	
Applicable Standards	EN60947-5-1, UL508, CSA 22.2. No. 14	
Rated Insulation Voltage	250V AC/DC	
Degree of Protection	IP65	
Conditional Short-Circuit Current and Short-Circuit Protective Device	50 A (at 250V) 10A 250V Fuse, operation class M according to IEC269-1 and IEC269-2	
Positive Opening Operation	Positive opening travel	3.4mm
	Minimum force required to achieve positive opening operation of all break contacts.	10.3 N (2 form B contacts)
	Maximum travel including travel beyond the minimum travel position	5.5mm
	Maximum frequency of actuation	1,200 operations/hour
Pollution Degree	3	

**Nameplates**

HAAV–Yellow Plastic

Marking	Part Number
Blank	HAAV-0

**Positive Action Stop Switch**

Style	Operation	Contact	Terminal Style	
			Solder Tab	PCB
Stop Switch 	Pushlock/ Turn Reset	DPST(NC) (2 form B)	HA1B-V2E2R	HA1B-V2E2VR
		Short Body SPST-NC (1 form B) DPST-NC (2 form B)	HA1E-V2S1R HA1E-V2S2R	—

**Accessories: Shroud**

Style	Part Number	Applicable Standards
	XA9Z-KG1	SEMI S2 Compliant (Approved by TUV)

1. Button is non-removable, available in red and as complete assembled unit only.
2. Stop Switch does not come with safety lever lock.

**Buzzers (IP40)**

Style	Operating Voltage	Terminal Style	
		Solder/Tab	PCB
Buzzer-Rectangular 	6V AC/DC ± 10%	LA3Z-1X2	LA3Z-1X2V
	12V to 24 AC/DC ± 10%	LA3Z-1X4	LA3Z-1X4V

**Buzzer Ratings**

Frequency	2 khz ± 500 HZ
Amplitude	80db @ 0.1m (at rated voltage)
Operating Voltage	6V AC/DC or 12 - 24V AC/DC ± 10%
Adjustable Cycle	55 to 600 cycles per minute
Current Draw	DC: 7mA AC: 20mA
Life	1000 hrs. minimum
Insulation Voltage	60V AC/DC
Operating Temperature	-20 to 55°C (no freezing), 45 to 85% RH
Degree of Protection	IP40

Pilot Lights (Assembled)

Pilot Lights

Style	Terminal Style	
	Solder Tab	PCB
Oversize Round 	HA1P-1C0③-②	HA1P-1C0③V-②
Oversize Square 	HA2P-1C0③-②	HA2P-1C0③V-②
Oversize Round Unibody 	HA1P-1③-②	—
Oversize Square Unibody 	HA2P-1③-②	—

② Lens/LED Color Codes

Color	Code
Amber	A
Green	G
Red	R
Blue	S
White	W
Yellow	Y

③ Voltage/Lamp Code

Voltage	Code
5V DC LED	1
6V AC/DC LED	2
12V AC/DC LED	3
24V AC/DC LED	4
120V AC LED	8
6V AC/DC Incandescent	5
12V AC/DC Incandescent	6
24V AC/DC Incandescent	7

- 1. In place of ② specify Lens/LED Color Code from table.
- 2. In place of ③ specify Voltage Code from table.

Pilot Lights (Sub-Assembled)

Terminals + Safety Lever Lock + Lamp Holder + Lamp + Operator + Lens = Completed Unit



Operators

Style	Part Number
Oversize Round	HA1P-0
Oversize Square	HA2P-0
Oversize Round Unibody	HA1P-00
Oversize Square Unibody	HA2P-00

Lenses

Style	Part Number
Oversize Round	HA1A-P1-②
Oversize Square	HA2A-P1-②

In place of ② specify lens color code.

Lamps

Style	Voltage	Part Number
LED	5V DC	LFTD-5②
	6V AC/DC	LFTD-6②
	12V AC/DC	LFTD-1②
	24V AC/DC	LFTD-2②
	120 V AC	LFTD-H2②
Incandescent	6V AC/DC	LH-06
	12V AC/DC	LH-14
	24V AC/DC	LH-28

In place of ② specify LED color code from table below.

Terminals

Style	Solder Tab	PCB
	HA-C00	HA-C00V

Not required for unibody operators.

Lamp Holder

Style	Part Number
	HA9Z-AH

Safety Lever Lock

Style	Part Number
	HA9Z-LS

② Lens/LED Color Codes

Color	Code
Amber	A
Green	G
Red	R
Blue	S
Yellow	Y
White	W

Illuminated Pushbuttons (Assembled)

Illuminated Pushbuttons

Style	Operation	Contact	Terminal Style	
			Solder Tab	PCB
Oversize Round 	Momentary	SPDT DPDT	HA1L-M1C5③-② HA1L-M1C6③-②	HA1L-M1C1③V-② HA1L-M1C2③V-②
	Maintained	SPDT DPDT	HA1L-A1C5③-② HA1L-A1C6③-②	HA1L-A1C1③V-② HA1L-A1C2③V-②
Oversize Square 	Momentary	SPDT DPDT	HA2L-M1C5③-② HA2L-M1C6③-②	HA2L-M1C1③V-② HA2L-M1C2③V-②
	Maintained	SPDT DPDT	HA2L-A1C5③-② HA2L-A1C6③-②	HA2L-A1C1③V-② HA2L-A1C2③V-②
Mushroom 	Momentary	SPDT DPDT	HA1L-M3C5③-② HA1L-M3C6③-②	HA1L-M3C1③V-② HA1L-M3C2③V-②
	Maintained	SPDT DPDT	HA1L-A3C5③-② HA1L-A3C6③-②	HA1L-A3C1③V-② HA1L-A3C2③V-②

② Lens Color Codes

Color	Code
Amber	A
Green	G
Red	R
Blue	S
Yellow	Y
White	W

③ Voltage/Lamp Code

Voltage	Code
5V DC LED	1
6V AC/DC LED	2
12V AC/DC LED	3
24V AC/DC LED	4
120 V AC LED	8
6V AC/DC Incandescent	5
12V AC/DC Incandescent	6
24V AC/DC Incandescent	7

- 1. In place of ② specify Lens Color Code from table.
- 2. In place of ③ specify Voltage Code from table.
- 3. PCB terminal models also available with silver contacts change "1" or "2" to "5" or "6" respectively, (ie LA1L-M1C14V-① becomes LA1L-M1C54V-①).
- 4. Light independent of switch position.

**Illuminated Pushbuttons (Sub-Assembled)**

Terminals + Safety Lever Lock + Lamp Holder + Lamp + Operator + Lens = Completed Unit



**Operators**

Style	Momentary	Maintained
 Oversize Round	HA1L-MO	HA1L-AO
 Oversize Square	HA2L-MO	HA2L-AO
 Mushroom	HA1B-MOL	HA1B-AOL



**Lenses**

Style	Part Number
 Oversize Round	HA1A-L1-Ⓢ
 Oversize Square	HA2A-L1-Ⓢ
 Mushroom	HA1A-L3-Ⓢ





In place of Ⓢ specify lens color code.

**Lamps**

Style	Voltage	Part Number
 LED	5V DC	LFTD-5Ⓢ
	6V AC/DC	LFTD-6Ⓢ
	12V AC/DC	LFTD-1Ⓢ
	24V AC/DC	LFTD-2Ⓢ
	120 V AC	LFTD-H2Ⓢ
 Incandescent	6V AC/DC	LH-06
	12V AC/DC	LH-14
	24V AC/DC	LH-28

**Contacts**

Style	Contacts	Terminal Style	
		Solder Tab	PCB
 Gold	SPDT	HA-C10	HA-C10V
	DPDT	HA-C20	HA-C20V
 Silver	SPDT	HA-C50	HA-C50V
	DPDT	HA-C60	HA-C60V

**Lamp Holder**

Style	Part Number
	HA9Z-AH

**Safety Lever Lock**

Style	Part Number
	HA9Z-LS

Ⓢ **Lens/LED Color Codes**

Color	Code
Amber	A
Green	G
Red	R
Blue	S
Yellow	Y
White	W



Selector Switches (Assembled)

Selector Switches

Style	Position	Contact	Terminal Style		
			Solder Tab	PCB	
Oversize Round	90° 2-Position	Maintained	DPDT	HA1S-2C6	HA1S-2C2V
		Spring return from right	DPDT	HA1S-21C6	HA1S-21C2V
Oversize Round	45° 3-Position	Maintained	DPDT	HA1S-3C6	HA1S-3C2V
		Spring return from right	DPDT	HA1S-31C6	HA1S-31C2V
		Spring return from left	DPDT	HA1S-32C6	HA1S-32C2V
		2-Way spring return	DPDT	HA1S-33C6	HA1S-33C2V



1. All assembled selector switches use DPDT contacts.
2. For SPDT contacts see sub-components on next page.
3. PCB terminal models also available with silver contacts change "1" or "2" to "5" or "6" respectively, (ie LA1S-21C2V becomes LA1S-21C6V).

Contact Operations

(for all selectors)

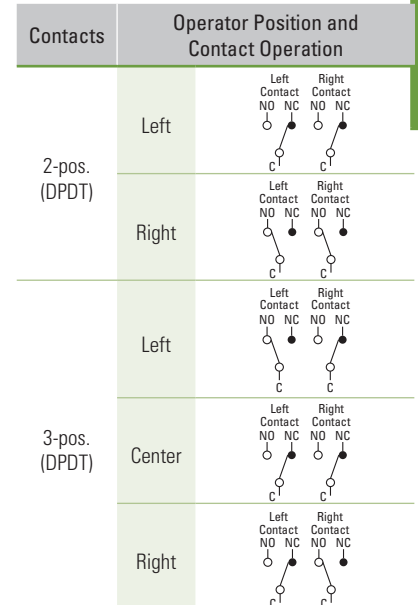

As viewed from front of switch.

**Selector Switches (Sub-Assembled)**

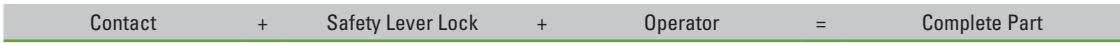

**Operators**

Style	Position	Function	Part Number
Oversize Round	2	Maintained Spring from right	HA1S-2Y HA1S-21Y
	3	Maintained Spring from right Spring from left Spring from both	HA1S-3Y HA1S-31Y HA1S-32Y HA1S-33Y



**Contacts**

Style	Contacts	Terminal Style	
		Solder Tab	PCB
	Gold SPDT DPDT	HA-C1	HA-C1V
		HA-C2	HA-C2V
	Silver SPDT DPDT	HA-C5	HA-C5V
		HA-C6	HA-C6V

**Safety Lever Lock**







Style	Part Number
	HA9Z-LS



1. All assembled switches listed on previous page use DPDT contacts.
2. SPDT Contacts for use on 2 position selector switch only

### Key Switches (Assembled)

#### Key Switches

Style	Position	Contact	Terminal Style		
			Solder Tab	PCB	
Oversize Round 	90° 2-Position	Maintained 	DPDT	HA1K-2C6 <sup>ⓐ</sup>	HA1K-2C2V <sup>ⓐ</sup>
		Spring return from right 	DPDT	HA1K-21C6B	HA1K-21C2VB
	45° 3-Position	Maintained 	DPDT	HA1K-3C6 <sup>ⓐ</sup>	HA1K-3C2V <sup>ⓐ</sup>
		Spring return from right 	DPDT	HA1K-31C6 <sup>ⓐ</sup>	HA1K-31C2V <sup>ⓐ</sup>
		Spring return from left 	DPDT	HA1K-32C6 <sup>ⓐ</sup>	HA1K-32C2V <sup>ⓐ</sup>
		2-Way spring return 	DPDT	HA1K-33C6D	HA1K-33C2VD

-  1. In place of <sup>ⓐ</sup> specify Key Retention Code from next page.
- 2. All assembled key switches have DPDT contacts. For SPDT see sub-assembled on next page.
- 3. PCB terminal models also available with silver contacts change "1" or "2" to "5" or "6" respectively, (ie LA1K-2C2V<sup>ⓐ</sup> becomes LA1K-2C6V<sup>ⓐ</sup>).

#### Contact Operations

(for all selectors)

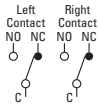
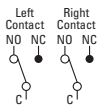
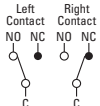
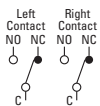
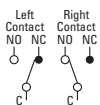
Contacts	Operator Position and Contact Operation	
2-pos. (DPDT)	Left	
	Right	
3-pos. (DPDT)	Left	
	Center	
	Right	

 As viewed from front of switch.

#### ⓐ Key Retention Option Codes

Code	Description
A	Key not retained in any position (removable in all positions)
B	Key retained in right position only
C	Key retained in left position only
D	Key retained in left and right (3 position only)
E	Key retained in center only (3 position only)
G	Key retained right and center (3 position only)
H	Key retained left and center (3 position only)

 Key cannot be removed from a spring-return position.

**Selector Switches (Sub-Assembled)**

Contact + Safety Lever Lock + Operator = Complete Part





**Operators**

Style	Position	Function	Part Number
Oversize Round 	2	Maintained Spring from right	HA1K-2ⓐ HA1K-21B
	3	Maintained Spring from right Spring from left Spring from both	HA1K-3ⓐ HA1K-31ⓐ HA1K-32ⓐ HA1K-33D

- 1. In place of ⓐ specify key removable code from table on right.
- 2. Operator includes two keys.

**Contacts**

Style	Contacts	Terminal Style	
		Solder Tab	PCB
	SPDT DPDT	HA-C1	HA-C1V
		HA-C2	HA-C2V
	SPDT DPDT	HA-C5	HA-C5V
		HA-C6	HA-C6V

- 1. All assembled switches listed on previous page use DPDT contacts.
- 2. SPDT Contacts for use on 2 position selector switch only

**Safety Lever Lock**

Style	Part Number
	HA9Z-LS





























**ⓐ Key Retention Option Codes**

Code	Description
A	Key not retained in any position (removable in all positions)
B	Key retained in right position only
C	Key retained in left position only
D	Key retained in left and right (3 position only)
E	Key retained in center only (3 position only)
G	Key retained right and center (3 position only)
H	Key retained left and center (3 position only)

- Key cannot be removed from a spring-return position.



Illuminated Selector Switches (Assembled)

Illuminated Selector Switches

Style	Position	Contact	Terminal Style		
			Solder Tab	PCB	
Round 	90° 2-Position	Maintained 	DPDT	LA1F-2C6③-②	LA1F-2C2③V-②
		Spring return from right 	DPDT	LA1F-21C6③-②	LA1F-21C2③V-②
	45° 3-Position	Maintained 	DPDT	LA1F-3C6③-②	LA1F-3C2③V-②
		Spring return from right 	DPDT	LA1F-31C6③-②	LA1F-31C2③V-②
		Spring return from left 	DPDT	LA1F-32C6③-②	LA1F-32C2③V-②
		2-Way spring return 	DPDT	LA1F-33C6③-②	LA1F-33C2③V-②
Square 	90° 2-Position	Maintained 	DPDT	LA2F-2C6③-②	LA2F-2C2③V-②
		Spring return from right 	DPDT	LA2F-21C6③-②	LA2F-21C2③V-②
	45° 3-Position	Maintained 	DPDT	LA2F-3C6③-②	LA2F-3C2③V-②
		Spring return from right 	DPDT	LA2F-31C6③-②	LA2F-31C2③V-②
		Spring return from left 	DPDT	LA2F-32C6③-②	LA2F-32C2③V-②
		2-Way spring return 	DPDT	LA2F-33C6③-②	LA2F-33C2③V-②
Rectangular 	90° 2-Position	Maintained 	DPDT	LA3F-2C6③-②	LA3F-2C2③V-②
		Spring return from right 	DPDT	LA3F-21C6③-②	LA3F-21C2③V-②
	45° 3-Position	Maintained 	DPDT	LA3F-3C6③-②	LA3F-3C2③V-②
		Spring return from right 	DPDT	LA3F-31C6③-②	LA3F-31C2③V-②
		Spring return from left 	DPDT	LA3F-32C6③-②	LA3F-32C2③V-②
		2-Way spring return 	DPDT	LA3F-33C6③-②	LA3F-33C2③V-②
Oversize Round 	90° 2-Position	Maintained 	DPDT	HA1F-2C6③-②	HA1F-2C2③V-②
		Spring return from right 	DPDT	HA1F-21C6③-②	HA1F-21C2③V-②
	45° 3-Position	Maintained 	DPDT	HA1F-3C6③-②	HA1F-3C2③V-②
		Spring return from right 	DPDT	HA1F-31C6③-②	HA1F-31C2③V-②
		Spring return from left 	DPDT	HA1F-32C6③-②	HA1F-32C2③V-②
		2-Way spring return 	DPDT	HA1F-33C6③-②	HA1F-33C2③V-②

Contact Operations

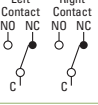
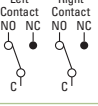
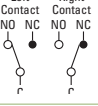
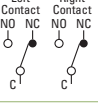
(for all selectors)

Contacts	Operator Position and Contact Operation	
2-pos. (DPDT)	Left	
	Right	
3-pos. (DPDT)	Left	
	Center	
	Right	

 As viewed from front of switch.

② Lens/LED Color Codes

Color	Code	Color	Code
Amber	A	Blue	S
Green	G	Yellow	Y
Red	R	White	W

③ Voltage/Lamp Code

Voltage	Code
5V DC LED	1
6V AC/DC LED	2
12V AC/DC LED	3
24V AC/DC LED	4
120V AC LED	8
6V AC/DC Incandescent	5
12V AC/DC Incandescent	6
24V AC/DC Incandescent	7

-  1. In place of ② specify Lens/LED Color Code from table above.  
 2. In place of ③ specify Voltage Code from table above.  
 3. All switches listed have DPDT contacts. For SPDT see sub-assembled on next page.  
 4. PCB terminal models also available with silver contacts change "1" or "2" to "5" or "6" respectively, (ie LA1F-2C24V-② becomes LA1F-2C64V-②).  
 5. Light independent of switch position.

**Illuminated Selector Switches (Sub-Assembled)**

Contacts + Safety Lever Lock + Lamp Holder + Lamp + Operator + Lens/Handle = Completed Unit



**Operators**

Style	Position	Function	Part Number
Round	2	Maintained	LA1F-20
		Spring from right	LA1F-210
	3	Maintained	LA1F-30
Square	2	Maintained	LA2F-20
		Spring from right	LA2F-210
	3	Maintained	LA2F-30
Rectangular	2	Maintained	LA3F-20
		Spring from right	LA3F-210
	3	Maintained	LA3F-30
Oversize Round	2	Maintained	HA1F-20
		Spring from right	HA1F-210
	3	Maintained	HA1F-30
		Spring from right	HA1F-310
		Spring from left	HA1F-320
		Spring from both	HA1F-330

**Safety Lever Lock**

Style	Part Number
	HA9Z-LS

**Lamp Holder**

Style	Part Number
	HA9Z-AH

**Lamps**

Style	Voltage	Part Number
LED	5V DC	LFTD-5Ⓜ
	6V AC/DC	LFTD-6Ⓜ
	12V AC/DC	LFTD-1Ⓜ
	24V AC/DC	LFTD-2Ⓜ
	120V AC	LFTD-H2Ⓜ
Incandescent	6V AC/DC	LH-06
	12V AC/DC	LH-14
	24V AC/DC	LH-28

In place of Ⓜ specify LED color code from table below.

**Contacts**

Style	Contacts	Terminal Style	
		Solder Tab	PCB
	SPDT	HA-C10	HA-C10V
	DPDT	HA-C20	HA-C20V
	SPDT	HA-C50	HA-C50V
	DPDT	HA-C60	HA-C60V

**Lenses/Handles**

Style	Part Number
Standard	
Oversize	

**Ⓜ Lens/LED Color Codes**

Color	Code
Amber	A
Green	G
Red	R
Blue	S
Yellow	Y
White	W

All assembled selectors on previous pages use DPDT contacts. SPDT contacts are for use only on two position selectors.

In place of Ⓜ specify lens color code from table.

Pushbutton Selectors (Assembled)

Pushbutton Selectors

Style	Terminal Style	
	Solder Tab	PCB
	2 Position	HA1R-2C6-Ⓞ HA1R-2C2V-Ⓞ
	3 Position	HA1R-3C6-Ⓞ HA1R-3C2V-Ⓞ

- 1. In place of Ⓞ specify Button Color Code.
- 2. PCB terminal models also available with silver contacts (change "1" or "2" to "5" or "6" respectively, ie HA1R-2C2V-Ⓞ becomes HA1R-2C6V-Ⓞ).
- 3. Pushed position, momentary only.

① Button Color Codes

Color	Code	Color	Code
Amber	A	Blue	S
Green	G	Yellow	Y
Red	R	White	W

Contact Operation

Style	Operator Position					
	Left		Center		Right	
	Normal	Pushed	Normal	Pushed	Normal	Pushed
2 Position			—	—		
3 Position				Blocked		

Contact Operation

Contacts	Operator Position and Contact Information	Operator Position and Contact Information		
		Down	Center	Up
2-pos. (DPDT)	Maintained Spring from Top			
2-pos. (DPDT)	Spring Return from Bottom			
3-pos. (DPDT)	All models			

 As viewed from front of switch.

Lever Switches

Style	Operation	Contacts	Terminal Type	
			Solder Tab	PCB
	Maintained		DPDT	LA1T-2C6 LA1T-2C2V
	Spring return from top		DPDT	LA1T-21C6 LA1T-21C2V
	Spring return from bottom		DPDT	LA1T-22C6 LA1T-22C2V
3-Position	Maintained		DPDT	LA1T-3C6 LA1T-3C2V
	Spring return from top		DPDT	LA1T-31C6 LA1T-31C2V
	Spring return from bottom		DPDT	LA1T-32C6 LA1T-32C2V
	Spring return from both		DPDT	LA1T-33C6 LA1T-33C2V

- 1. PCB terminal models also available with silver contacts (change "1" or "2" to "5" or "6" respectively, ie LA1T-2C2V becomes LA1T-2C6V).
- 2. Terminology: U = up, D = down, C = center.

### Switch Engraving Order Form – L6 Series

Copy this order form and use it to specify Letter Height, Maximum Number of Lines and Text to be engraved.

To insure engraving accuracy, fax it to your IDEC representative or Distributor.

Your Company: \_\_\_\_\_  
 Name: \_\_\_\_\_  
 Address: \_\_\_\_\_  
 PO: \_\_\_\_\_

Telephone: \_\_\_\_\_  
 Fax: \_\_\_\_\_  
 Email: \_\_\_\_\_  
 Part Number to be Engraved: \_\_\_\_\_

Please check one of the boxes below to indicate your choice of engraving options:

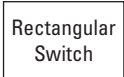

	# of Lines	Letter Height	Max. Characters Per Line
<input type="checkbox"/>	1	5/32	6
<input type="checkbox"/>	2	5/32	6
<input type="checkbox"/>		1/8	6
<input type="checkbox"/>	3	1/8	6
<input type="checkbox"/>	4	N/A	

	# of Lines	Letter Height	Max. Characters Per Line
<input type="checkbox"/>	1	5/32	5
<input type="checkbox"/>	2	5/32	5
<input type="checkbox"/>		1/8	6
<input type="checkbox"/>	3	1/8	6
<input type="checkbox"/>	4	N/A	

	# of Lines	Letter Height	Max. Characters Per Line
<input type="checkbox"/>	1	5/32	3
<input type="checkbox"/>		1/8	3
<input type="checkbox"/>	2	Custom*	
<input type="checkbox"/>	3	Custom*	
<input type="checkbox"/>	4	N/A	

\*Engraving is possible, but character size will be smaller than standard sizes.



- Above mentioned specifications hold true for standard size pushbuttons (round, square and rectangular).
- Oversize pushbuttons and pilot lights allow you to engrave 1 additional character.
- Engraving is done on the button itself for non-illuminated push buttons and on marking plate for illuminated pushbuttons and pilot lights.
- Please enter text exactly how you want it engraved, take care to emphasize capital or small letters.

Enter text to be engraved:

Line 1: \_\_\_\_\_  
 Line 2: \_\_\_\_\_  
 Line 3: \_\_\_\_\_  
 Line 4: \_\_\_\_\_

#### Sample Letter Sizes

1/8 Letters: **OPEN**

5/32 Letters: **OPEN**

For IDEC Internal Use Only:  
 Work Order #: \_\_\_\_\_



Accessories

Item	Appearance	Specifications	Part Number	Notes	
Ring Wrench		Made of metal	MT-001	Used for tightening the plastic locking ring when installing the L6 series unit on a panel. Tightening torque should not exceed 9kgf cm when tightening the locking ring.	
Lamp Holder Tool (Made of Rubber)		Made of rubber. Used for removing and replacing LED and incandescent lamps in illuminated units.	OR-44	Rubber tool used for replacing LED and incandescent lamps.	
Lens Removal Tool		For illuminated pushbuttons and pilot lights.	MT-101	Used for removing the lens or button from the housing.	
LED Lamp		5V DC 6V AC/DC 12V AC/DC 24V AC/DC 120V AC	LFTD-5Ⓢ LFTD-6Ⓢ LFTD-1Ⓢ LFTD-2Ⓢ LFTD-H2Ⓢ	T 1-3/4 miniature flange base. In place of Ⓢ specify LED Color Code (A, G, R, S, W, Y).	
Incandescent Lamp		6V AC/DC 12V AC/DC 24V AC/DC	LH-06 LH-14 LH-28	0.5W, T 1-3/4 miniature flange base	
Switch Guard		180 degrees opening, spring return	HA9Z-K1	Prevents inadvertent switch operation. IP65 oiltight rated.	
Terminal Cover		Made of white nylon	All removable contacts	H6-VL2	Covers terminals to prevent possible electric shock.
			Unibody Pilot Lights	H6-PVL	
Mounting Hole Plug		Rubber	AL-B6	Fills unused panel cutouts. Made of nitrile rubber. Push-in installation from front of panel. IP65 (oiltight) rated.	
		Aluminum	AL-BM6	Fills unused panel cutouts. Made of aluminum. Screw-on locking ring from inside of panel. IP65 (oiltight) rated.	
Replacement Keys		for HA1K (#231) – oversize	KG9Z-SK	Pair of keys.	
Replacement Engraving Inserts			HA9Z-P1-W HA9Z-P2-W HA9Z-P13-W		
Replacement Locking Ring		All models	HA9Z-LN		
Replacement Anti-Rotation Ring			HA9Z-LP	Prevents rotation of switches in panel. (included with all assembled switches)	
Replacement Selector Inserts			HA9Z-HC1-Ⓢ	Applicable to round oversize selectors only Ⓢ = (G, R, S, W, Y)	
Replacement Safety Lever Lock			HA9Z-LS		

Switches & Pilot Devices

Signaling Lights

Relays & Sockets

Timers

Contactors

Terminal Blocks

Circuit Breakers

Item	Appearance	Description	Used With	Part Number
Flush Bezel		ø24mm round, metal (aluminum color), panel cut-out ø20.2mm	Illuminated selector switches. L6 Switch + Flush Bezel = Flush Switch	LA9Z-SM61
		ø24mm round, plastic (black), panel cut-out ø20.2mm		LA9Z-S61B
		□24mm square, plastic (black), panel cut-out □20.2mm		LA9Z-S71B
		24 x 30mm rectangular, plastic (black), panel cut-out ø20.2 x 26.2mm		LA9Z-S81B
Switch Guard w/ Flush Bezel (spring return)		Rectangular, plastic (black)		LA9Z-KS8

Flush bezels not applicable for oversize units.

**Dimensions (mm)**

**Lever Switches (LA1T)**

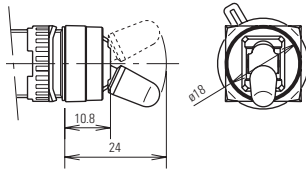

**Buzzer (LA3Z)**

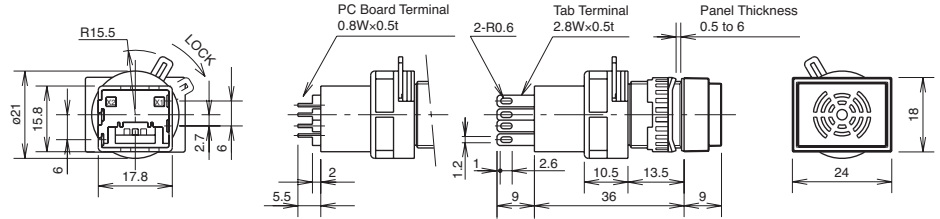

**Emergency Stop Switch (HA1B)**

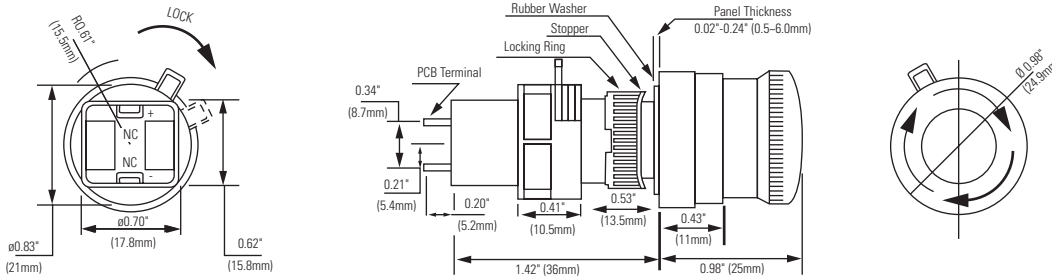

**Emergency Stop Switch (HA1E) - Short Body Style**

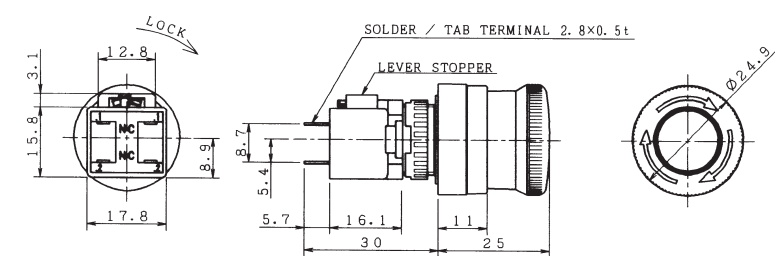

Illuminated Selector Switches (LA\*F)

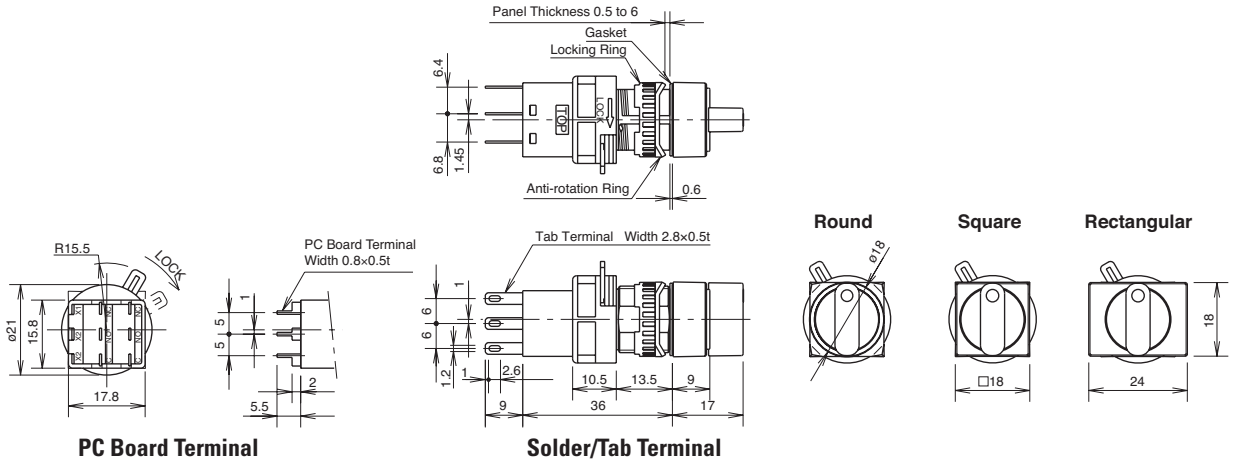

PC Board Drilling Layout (Bottom View)

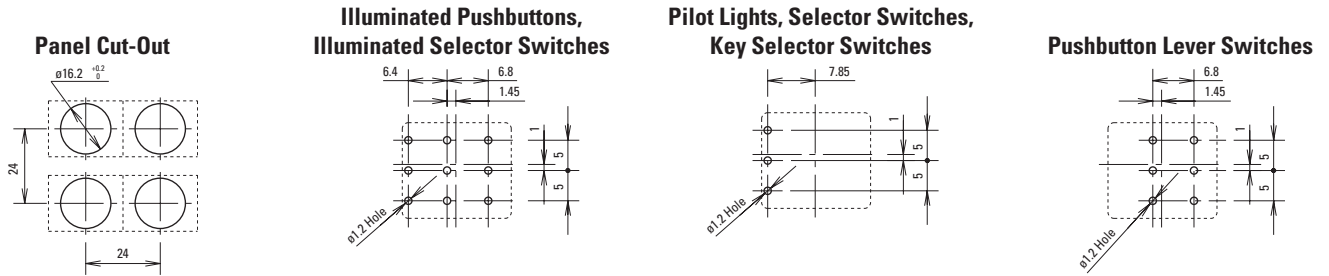

HA1B E-Stop

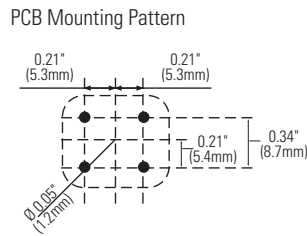

Oversize Flush Pushbutton and Pilot Lights

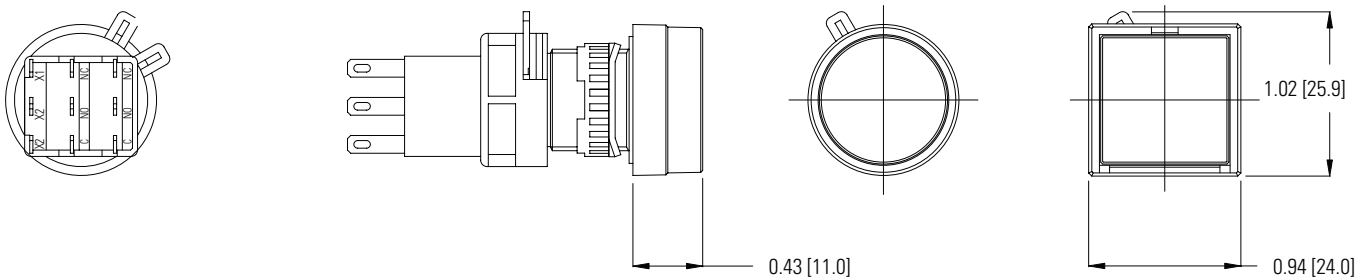

**Enlarge Extended Non-Illuminated Pushbutton**

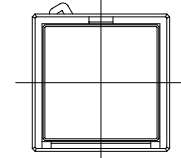
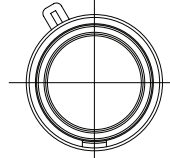
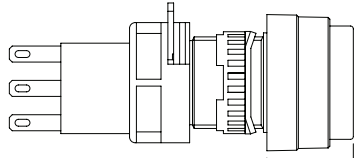
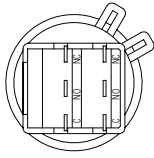

0.59 [15.1]

**Enlarge Unibody Pilot Lights**

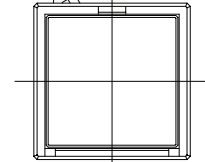
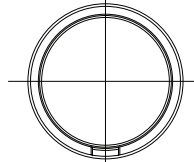
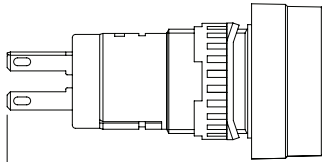
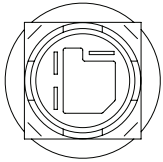

1.48 [37.5]

**Mushroom Pushbuttons**

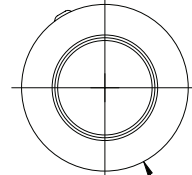
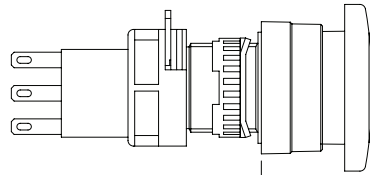
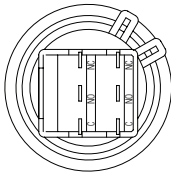

1.18 [30.0]

**Enlarge Selector Switch**

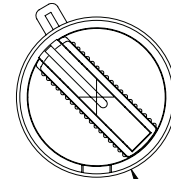
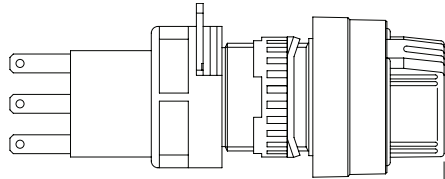
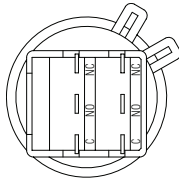

0.94 [23.8]

0.77 [19.5]

Oversize Key Switch

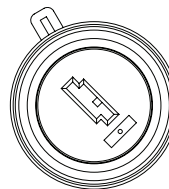
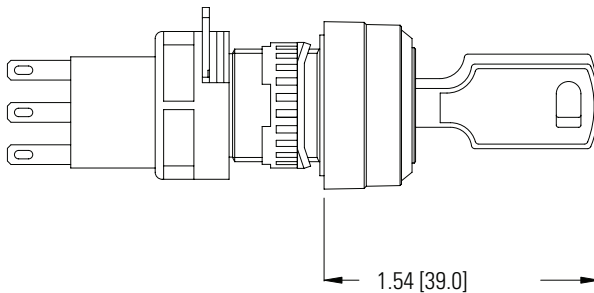
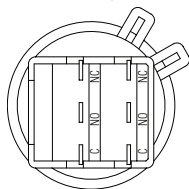

Lever Switch

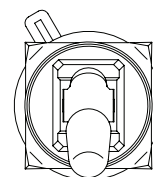
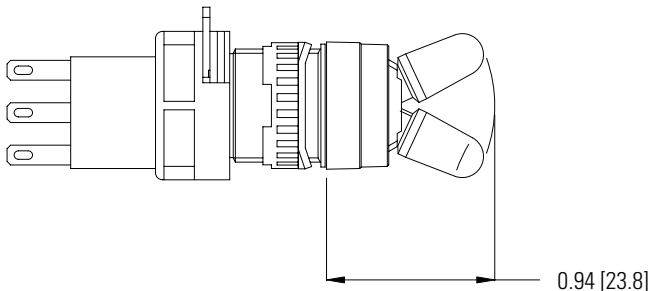
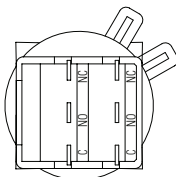

Flush Bezel

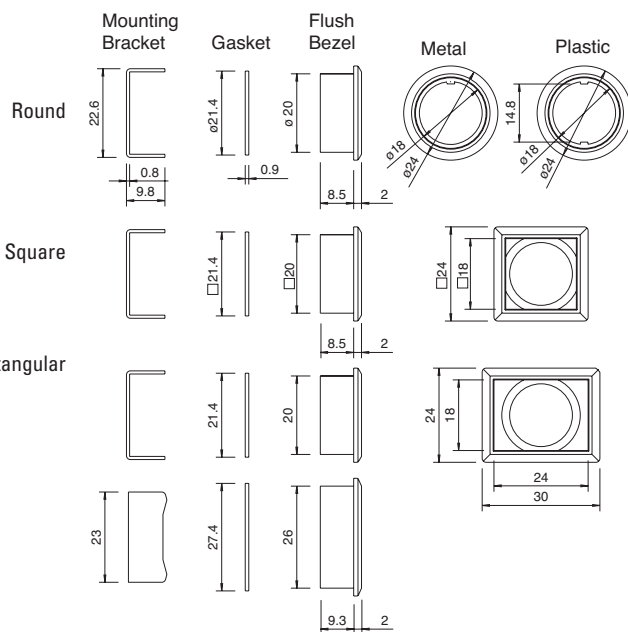

Selector Switches

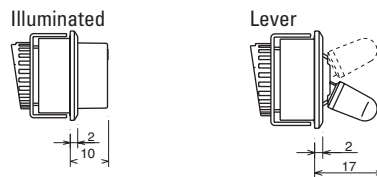

Flush Bezel Mounting Hole Layout

Round

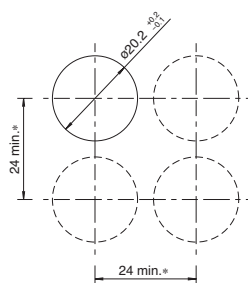

Square

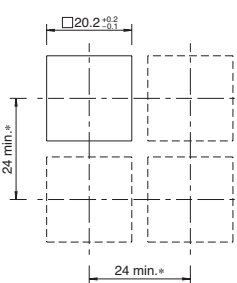

Rectangular

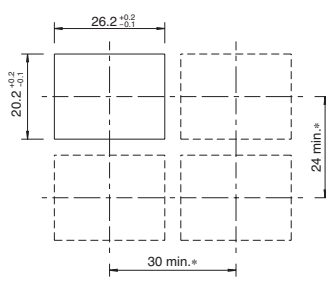

Terminal Configurations

Non Illuminated Pushbutton

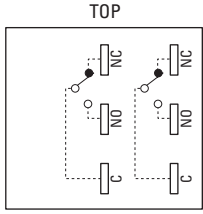

Pilot Lights

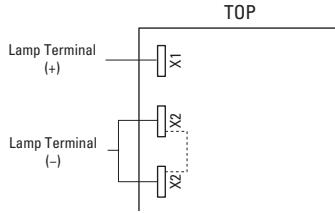

AL-K6SP

Illuminated Pushbuttons

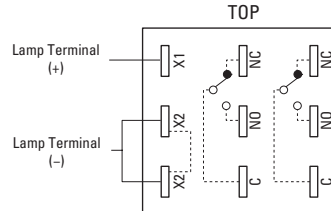

Buzzer

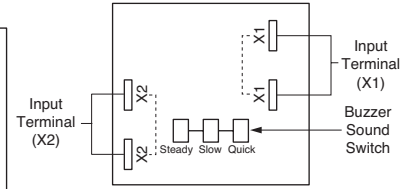

H6-VL2

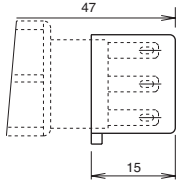

AL-B6

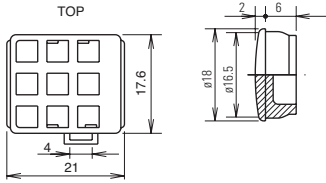

AL-BM6

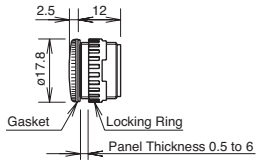

LFTD

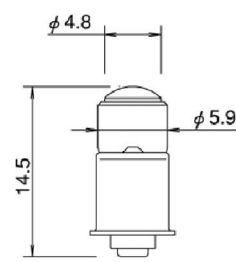

LED Lamp Internal Circuit

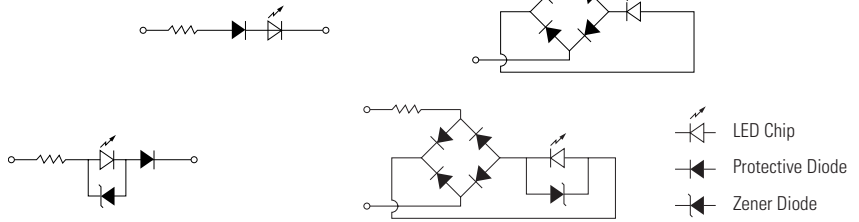

AL-B6

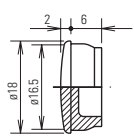

## General Instructions

### Pushbutton Assembly Lamp Installation

Lamps can be replaced in two ways:

1. If contacts are accessible (or pushbutton not installed in a panel) then it is easiest to first remove the contacts from the operator. This will allow easy access to the lamp/lamp-holder assembly. Grab lamp, depress slightly, and turn counter clockwise. Lamp can then be removed by pushing it back through the lamp holder.
2. If contacts are not accessible, then the lamp can be replaced by first removing the lens from the operator. Just pull lens straight out either with a fingernail or optional lens removal tool (MT-101). Lamp/lamp-holder assembly can then be removed with lamp removal tool (OR-44). Insert lamp removal tool through operator, depress slightly, turn counter clockwise, then pull lamp/lamp-holder assembly out. Lamp can then be removed by pushing it back through the lamp holder.

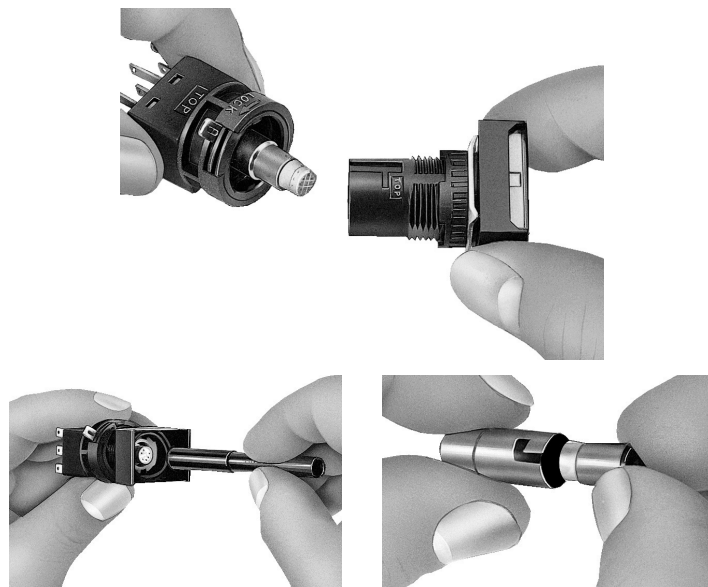

### Engraving Lenses

All buttons and lenses can be engraved directly on the outside surface. Illuminated lenses also allow for engraving on a plate that is underneath the colored section of the lens. Remove the colored section of the lens by pulling on the edge while simultaneously unhooking it from the latches on the lens holder. The marking plate will then be accessible. It can then be engraved or a thin marked insert (such as mylar or paper) can be sandwiched between the marking plate and colored section of the lens.

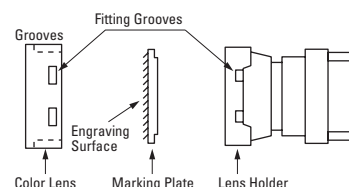

### Panel Mounting

Before any unit can be mounted into a panel, the contact block must be removed. Slide metal locking lever and pull contact off. Loosen and remove the locking ring and square anti-rotation ring from the operator and insert operator through panel cutout from the front of the panel. Slide on anti-rotation ring and tighten locking ring, using locking ring wrench (MT-001). Slide contact block onto operator, observing TOP marking on both parts. Slide metal locking lever in direction indicated by LOCK. The yellow plastic safety lever lock can then be snapped onto the locking lever; this will prevent vibration or maintenance actions from releasing the contact from the operator.

### PCB Mounting

Being able to separate the contacts from the operator allows for assembly of the front panel components (operator and lens) to be performed in tandem with the PC board assembly and soldering. For applications where multiple rows of push-buttons are mounted closely together, or where other components may obstruct access to the contact locking lever, be sure to include access holes in the PC board (refer to PC board layout dimensions for location). Also be sure to allow for space above and to the side of contact to ensure that no components block the contact block locking lever. PC board pins are designed to rest on the PCB, take this into consideration to ensure that pins do not short closely spaced traces.

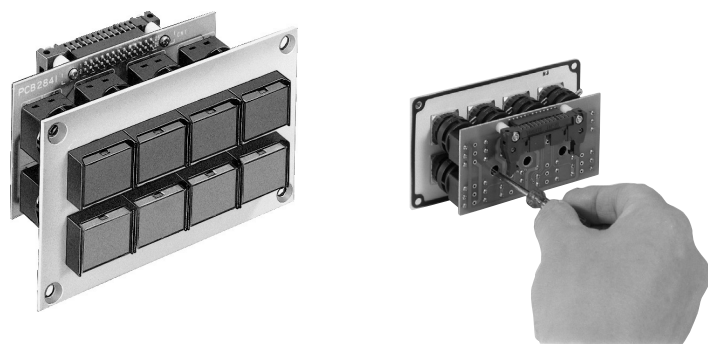

## X-ON Electronics

Largest Supplier of Electrical and Electronic Components

*Click to view similar products for [Industrial Panel Mount Indicators / Switch Indicators](#) category:*

*Click to view products by [Idec](#) manufacturer:*

Other Similar products are found below :

[LW1A-P1-GD](#) [LW1A-P1-W](#) [01-931.3](#) [01-152.025](#) [73.362.4028.0](#) [750-1520](#) [9001OA120](#) [A0142N5](#) [A3DT-500Y](#) [AL6M-LK3-R](#) [AL6M-P7P-A](#) [AOLQW-2B0600](#) [AP1M255-A](#) [APD106LN-G](#) [APD106LN-S](#) [APN1126-G](#) [APS122DN-W](#) [ASLWLD-G](#) [ASLWLD-R](#) [ATN2100](#) [AYLW4L-A](#) [18-237.035](#) [18-945](#) [HW1A-L1-GD](#) [HW1A-P2-GL](#) [HW1X-BM411-R](#) [HW2A-L1-GL](#) [HWAZ1N-OB](#) [PA2100/2](#) [PA2200/1](#) [PA2SHIELD](#) [PAMR25](#) [LA3P-1C03V-Y](#) [96-923.5](#) [A0244J2](#) [LSPD-120A](#) [LSPD-1Y](#) [LSPD-6A](#) [LSPD-6DA](#) [LSPD-6DW](#) [LSPD-6DY](#) [LSPD-6R](#) [LSPD-6W](#) [18-946](#) [AL6H-LK3-A](#) [AL6H-P4-JW](#) [AL6M-LK1-MG](#) [AP8M155-G](#) [APD106LN-W](#) [APN106L-O](#)