

HW Series – 22mm IEC Style Global Pushbuttons

Key features:

- Locking lever removable contact blocks
- Finger-safe IP20 contacts
- Tamperproof construction
- All E-stops meet EN60947-5-5, and are compliant with SEMI S2 standards
- Worldwide approvals
- Easy to assemble
- Choice of black plastic or metallic front bezels
- LED illumination
- Transformer or full voltage
- Slow make double break contacts



HW: The Best Engineered Switch in the World

IDEC's HW switches are "The best engineered switch in the world" for a reason. Carrying the CE mark, UL, CSA, CCC (Chinese), and TUV approvals, these switches are designed for use in almost any part of the world.

include illuminated and non-illuminated pushbuttons, pilot lights, selector switches, and emergency stop switches.

Complete with finger-safe contact blocks offering IP20 protection, these 7/8" (22mm) switches

All switches also incorporate mechanically keyed safety locking levers, ensuring correct installation and maintaining safety in high-vibration applications.



File No. E68961



File No. LR21451



Certificate No. R50086203_HW_e-stop R50391189_HW



Certificate No. 2017010305987846

Specifications

| | | | | | | | |
|--|---|--|-------------------|--|------------------------------------|--|-------------------|
| Electrical | Rated Operational Characteristics | AC-15: A600 or Ue = 250V, Ie = 3A (NO, NC, NO-EM, NC-LB) DC-13: P600 or Ue = 125V, Ie = 1.1A (NO, NC) DC-13: Q600 or Ue = 125V, Ie = 0.9A (NO-EM, NC-LB) | | | | | |
| | Rated Insulation Voltage | 600V | | | | | |
| | Rated Switching Over-Voltage | Less than 4kV, conforming to IEC60947-1 | | | | | |
| | Rated Impulse Withstanding Voltage | 4kV for contact circuit, 2.5kV for lamp circuit | | | | | |
| | Rated Thermal Current | 10 Amp | | | | | |
| | Minimum Switching Capacity | 5 mA at 3V AC/DC | | | | | |
| | Electrical Reliability | MTBF < 1 fault for 10 million operation cycles (3V DC, 5mA) | | | | | |
| | Lamp Ratings | LEDs: 6V/17mA max, 12V & 24V/11mA max, 120 & 240V/10mA max | | | | | |
| Mechanical | Contact Operation | Slow break NC or NO | | | | | |
| | Positive Action Operation (Emergency Stops with NC contacts) | 5.5mm to 10mm travel to latch, 45N minimum force to latch 10mm maximum travel, 1,800 operations per hour maximum for a Pushlock Turn Reset 900 operations per hour maximum for a Push-Pull | | | | | |
| | Operating Force | Flush and extended pushbuttons—with 1NO or 1NC contact: 6.2±2N (momentary), 7.0±2N (maintained) Additional contacts—1NO or 1NC: +3.2N (momentary), + 3.3N (maintained) | | | | | |
| | Recommended Terminal Torque | Unit | Wire | Number of Wires | Recommended Tightening Torque (Nm) | Terminal Screw | |
| | | | | | | | Crimping Terminal |
| | | HW-U Contact Block | Solid Wire | ø0.5 to 1.6 mm (AWG14 to 22) | 2 | 1.0 to 1.3 | |
| | | | Stranded Wire | 0.3 to 2.0 mm ² (AWG14 to 22) 2.1 to 3.5 mm ² (AWG12) | 1 2 1 | 1.2 to 1.3 1.0 to 1.3 1.2 to 1.3 | |
| | Illuminated Unit (*1) | Crimping Terminal | Solid Wire | ø0.5 to 1.6 mm (AWG14 to 22) | 2 | 1.0 to 1.3 | M3.5 |
| | | | Stranded Wire | 0.3 to 2.0 mm (AWG14 to 22) | | | |
| | Applicable Wire Size | Pilot Light | Crimping Terminal | Solid Wire | ø0.5 to 1.6 mm (AWG14 to 22) | 2 | 0.6 to 1.0 (M3.0) |
| Stranded Wire | | | | ø0.3 to 2.0 mm (AWG14 to 22) | 1.0 to 1.3 (M3.5) | | |
| 1. * refers to the lamp terminals of the illuminated push buttons and selector switches. | | | | | | | |
| Applicable Wire Size | Minimum 1 x 22 AWG, max. 2 x 14 AWG or 1 x 12 AWG | | | | | | |
| Contact Resistance | Initial contact resistance of 50mΩ or less | | | | | | |
| Contact Gap | 4mm (NO and NC), 2mm (NO-EM and NC-LB) | | | | | | |
| Horsepower Rating | Reference Value: 1/4 HP @ 120V (1ø non-reversing), 1HP @ 240V (3ø non-reversing) | | | | | | |
| Contact Material | Silver (gold plated contacts available - contact IDEC) | | | | | | |
| Operating Temperature | Operation: -25 to +60°C (illuminated -25 to +50°C dome -25 to +55°C) | | | | | | |
| Vibration Resistance | 10 to 55Hz, 98m/sec ² (10G) conforming to IEC6068-2-6 | | | | | | |
| Shock Resistance | 980m/sec ² (100G) conforming to IEC6068-2-7 | | | | | | |
| Mechanical Life | Momentary pushbuttons: 5,000,000 (900 operations per hour), All other switches: 500,000 | | | | | | |

Switches & Pilot Devices

Signaling Lights





Relays & Sockets

Timers

Contactors

Terminal Blocks

Circuit Breakers

| | | | | | | | | | |
|-------------------------|--|---|--|-----|-----|------------------------------|------|------|----|
| Conforming to Standards | | EN60947-1, EN60947-5-1, VDE0660-200, UL508, CSA C22-2 No.14 | | | | | | | |
| Standards & Approvals |  File No. E68961  File No. LR92374    Registration No. R9551089 (E-stops) Registration No. R50054316 (Dual Pushbuttons) Registration No. J9650511 (Pilot Lights) Registration No. J9551458 (all other switches) | | CSA: pushbuttons and selector switches: A600 pilot lights and illuminated pushbuttons, direct supply pilot lights and illuminated pushbuttons with integral transformer (100/110, 115, 120, 200/220, 230, 240, 380, 400/440, 480V) UL: pushbuttons and selector switches: A600 pilot lights and illuminated pushbuttons, direct supply pilot lights and illuminated pushbuttons with integral transformer (100/110, 115, 120, 200/220, 230, 240, 380, 400/440, 480V) TÜV: pushbuttons and selector switches: A600=P600 (NO, NC)/O600 (NO-EM, NC-LB) pilot lights and illuminated pushbuttons, direct supply pilot lights and illuminated pushbuttons with integral transformer (100/110, 115, 120, 200/220, 230, 240, 380, 400/440, 480V) | | | | | | |
| | Electric Shock Protection | | Class 2 conforming to IEC60664-7 | | | | | | |
| | Degree of Protection (conforming to IEC60529 and UL50) | | UL Type 1, 4X, 12, 13 ¹ IP65 (from front of the panel) IP20 (Type HW-U contact block) | | | | | | |
| | Pollution Degree (conforming to IEC60947-1) | | 3 | | | | | | |
| | External Short-Circuit Protection | | 10A 250V fuse conforming to IEC60269-1 | | | | | | |
| Contact Ratings | Pushbuttons Illuminated Pushbuttons Selector Switches Illuminated Selector Switches Pushbutton Selector | | Contact Block | | | Type HW-U | | | |
| | | | Rated Insulation Voltage | | | 600V | | | |
| | | | Rated Continuous Current | | | 10A | | | |
| | | | Contact Ratings by Utilization Category IEC 60947-5-1 | | | AC-15 (A600) DC-13 (P600) | | | |
| Characteristics | Operational Voltage | | 24V | 48V | 50V | 110V | 220V | 440V | |
| | Operational Current | AC 50/60 Hz | AC-12 Control of resistive loads & solid state loads | 10A | — | 10A | 10A | 6A | 2A |
| | | | AC-15 Control of electromagnetic loads (> 72VA) | 10A | — | 7A | 5A | 3A | 1A |
| | | DC | DC-12 Control of resistive loads & solid state loads | 10A | 5A | — | 2.2A | 1.1A | — |
| | | | DC-13 Control of electromagnets | 5A | 2A | — | 1.1A | 0.6A | — |

 For dimensions, see page 685.
Note 1. Except HW2B

LED Lamp Ratings (LSTD Type)

| Model | | LSTD-6Ⓢ | LSTD-1Ⓢ | LSTD-2Ⓢ | LSTD-H2Ⓢ | LSTD-M4Ⓢ |
|------------------------|---|---|---|----------------|-------------|-------------|
| Lamp Base | | BA9S/13 | | | | |
| Rated Voltage | | 6V AC/DC | 12V AC/DC | 24V AC/DC | 120V AC | 240V AC |
| Voltage Range | | 6V AC/DC ±10% | 12V AC/DC ±10% | 24V AC/DC ±10% | 120V AC ±5% | 240V AC ±5% |
| Current Draw | AC | A, R, W: G, S: 17mA 8mA | 11mA | 11mA | 10mA | 10mA |
| | DC | A, R, W: G, S: 14mA 5.5mA | 10mA | 10mA | — | — |
| Color Code | | A (amber), G (green), R (red), S (blue), W (white) | | | | |
| Lamp Base Color | | Same as illumination color | | | | |
| Voltage Marking | | Die stamped on the base | | | | |
| Life (reference value) | | Approx. 50,000 hours (The luminance reduces to 50% the initial intensity when used on complete DC.) | | | | |
| Internal Circuit | A, R, W | | A, R, W | | | |
| |  | |  | | | |
| | G, S | |  | | | |
| | |  LED Chip  Protection Diode  Zener Diode | | | | |

 In place of Ⓢ, specify the Lens/LED Color Code.

Non-Illuminated Round Pushbuttons (Assembled)



| Function | Contacts | Round Flush | | Round Extended | |
|------------|---------------|---------------|--------------|----------------|--------------|
| | | Plastic Bezel | Metal Bezel | Plastic Bezel | Metal Bezel |
| Momentary | Operator Only | HW1B-M1-① | HW4B-M1-① | HW1B-M2-① | HW4B-M2-① |
| | 1NO | HW1B-M1F10-① | HW4B-M1F10-① | HW1B-M2F10-① | HW4B-M2F10-① |
| | 1NC | HW1B-M1F01-① | HW4B-M1F01-① | HW1B-M2F01-① | HW4B-M2F01-① |
| | 1NO-1NC | HW1B-M1F11-① | HW4B-M1F11-① | HW1B-M2F11-① | HW4B-M2F11-① |
| | 2NO | HW1B-M1F20-① | HW4B-M1F20-① | HW1B-M2F20-① | HW4B-M2F20-① |
| | 2NC | HW1B-M1F02-① | HW4B-M1F02-① | HW1B-M2F02-① | HW4B-M2F02-① |
| | 2NO-2NC | HW1B-M1F22-① | HW4B-M1F22-① | HW1B-M2F22-① | HW4B-M2F22-① |
| Maintained | Operator Only | HW1B-A1-① | HW4B-A1-① | HW1B-A2-① | HW4B-A2-① |
| | 1NO | HW1B-A1F10-① | HW4B-A1F10-① | HW1B-A2F10-① | HW4B-A2F10-① |
| | 1NC | HW1B-A1F01-① | HW4B-A1F01-① | HW1B-A2F01-① | HW4B-A2F01-① |
| | 1NO-1NC | HW1B-A1F11-① | HW4B-A1F11-① | HW1B-A2F11-① | HW4B-A2F11-① |
| | 2NO | HW1B-A1F20-① | HW4B-A1F20-① | HW1B-A2F20-① | HW4B-A2F20-① |
| | 2NC | HW1B-A1F02-① | HW4B-A1F02-① | HW1B-A2F02-① | HW4B-A2F02-① |
| | 2NO-2NC | HW1B-A1F22-① | HW4B-A1F22-① | HW1B-A2F22-① | HW4B-A2F22-① |

① Button Color Code

| Color | Code |
|--------|------|
| Black | B |
| Green | G |
| Red | R |
| Blue | S |
| White | W |
| Yellow | Y |



1. In place of ①, specify the Button Color Code from table below.
2. For nameplates and accessories, see page 680 and 683.
3. For dimensions, see page 685.
4. For contact assembly part numbers, see page 685.
5. All assembled part numbers in catalog include standard, Finger-Safe (HW-U...) contacts.
6. Operator only models include operator plus button.
7. Additional contact configurations available (up to 6 total contacts).

Part Number Structure



Note: Use only for interpreting part numbers. Do not use for developing part numbers.

Non-Illuminated Round Pushbuttons (Replacement Parts)



Contact Blocks

| Style | Contacts | 1NO | 1NC |
|-------|--------------------------------|------------------------|------------------------|
| | Finger-Safe Spring-Up Terminal | HW-U10-F | HW-U01-F |
| | | HW-U10R-F (early make) | HW-U01R-F (late break) |
| | Dummy Block | HW-DB | |

Anti-Rotation Ring

| Style | Part Number |
|-------|-------------|
| | HW9Z-RL |

Use with notched panel cutout to prevent unit rotation.

Buttons

| Style | Part Number |
|--------------------|-------------|
| Round Flush | HW1A-B1-① |
| Round Extended | HW1A-B2-① |

1. In place of ①, specify the Button Color Code from table.

① Button Color Code

| Color | Code |
|--------|------|
| Black | B |
| Green | G |
| Red | R |
| Blue | S |
| White | W |
| Yellow | Y |

Contact Block Mounting Adaptor

| Style | Part Number |
|-------|-------------|
| | HW-CB2C |

1. Used to mount contact blocks to operator.
2. IDEC strongly recommends using the safety lever lock to prevent heavy vibration or maintenance personnel from inadvertently unlocking contacts.

Operators

| Style | | Plastic Bezel | Metal Bezel |
|------------------------------|----------------|---------------|-------------|
| Round Flush/ Extended | Momentary | HW1B-M0 | HW4B-M0 |
| | Maintained | HW1B-A0 | HW4B-A0 |

Safety Lever Lock

| Style | Part Number |
|-------|-------------|
| | HW9Z-LS |

Non-Illuminated Mushroom Head Pushbuttons (Assembled)



| | | ø29mm Mushroom Head | | ø40mm Mushroom Head | |
|------------|---------------|---------------------|--------------|---------------------|--------------|
| Function | Contacts | Plastic Bezel | Metal Bezel | Plastic Bezel | Metal Bezel |
| Momentary | Operator Only | HW1B-M3-Ⓢ | HW4B-M3-Ⓢ | HW1B-M4-Ⓢ | HW4B-M4-Ⓢ |
| | 1NO | HW1B-M3F10-Ⓢ | HW4B-M3F10-Ⓢ | HW1B-M4F10-Ⓢ | HW4B-M4F10-Ⓢ |
| | 1NC | HW1B-M3F01-Ⓢ | HW4B-M3F01-Ⓢ | HW1B-M4F01-Ⓢ | HW4B-M4F01-Ⓢ |
| | 1NO-1NC | HW1B-M3F11-Ⓢ | HW4B-M3F11-Ⓢ | HW1B-M4F11-Ⓢ | HW4B-M4F11-Ⓢ |
| | 2NO | HW1B-M3F20-Ⓢ | HW4B-M3F20-Ⓢ | HW1B-M4F20-Ⓢ | HW4B-M4F20-Ⓢ |
| | 2NC | HW1B-M3F02-Ⓢ | HW4B-M3F02-Ⓢ | HW1B-M4F02-Ⓢ | HW4B-M4F02-Ⓢ |
| | 2NO-2NC | HW1B-M3F22-Ⓢ | HW4B-M3F22-Ⓢ | HW1B-M4F22-Ⓢ | HW4B-M4F22-Ⓢ |
| Maintained | Operator Only | HW1B-A3-Ⓢ | HW4B-A3-Ⓢ | HW1B-A4-Ⓢ | HW4B-A4-Ⓢ |
| | 1NO | HW1B-A3F10-Ⓢ | HW4B-A3F10-Ⓢ | HW1B-A4F10-Ⓢ | HW4B-A4F10-Ⓢ |
| | 1NC | HW1B-A3F01-Ⓢ | HW4B-A3F01-Ⓢ | HW1B-A4F01-Ⓢ | HW4B-A4F01-Ⓢ |
| | 1NO-1NC | HW1B-A3F11-Ⓢ | HW4B-A3F11-Ⓢ | HW1B-A4F11-Ⓢ | HW4B-A4F11-Ⓢ |
| | 2NO | HW1B-A3F20-Ⓢ | HW4B-A3F20-Ⓢ | HW1B-A4F20-Ⓢ | HW4B-A4F20-Ⓢ |
| | 2NC | HW1B-A3F02-Ⓢ | HW4B-A3F02-Ⓢ | HW1B-A4F02-Ⓢ | HW4B-A4F02-Ⓢ |
| | 2NO-2NC | HW1B-A3F22-Ⓢ | HW4B-A3F22-Ⓢ | HW1B-A4F22-Ⓢ | HW4B-A4F22-Ⓢ |



| | | ø60mm Mushroom Head |
|-----------|---------------|---------------------|
| Function | Contacts | Plastic Bezel |
| Momentary | Operator Only | HW1B-M5-Ⓢ* |
| | 1NO | HW1B-M5F10-Ⓢ* |
| | 1NC | HW1B-M5F01-Ⓢ* |
| | 1NO-1NC | HW1B-M5F11-Ⓢ* |
| | 2NO | HW1B-M5F20-Ⓢ* |
| | 2NC | HW1B-M5F02-Ⓢ* |
| | 2NO-2NC | HW1B-M5F22-Ⓢ* |

Ⓢ Button Color Code

| Color | Code |
|--------|------|
| Black | B |
| Green | G |
| Red | R |
| Blue | S |
| White | W |
| Yellow | Y |



1. In place of Ⓢ, specify the Button Color Code from table.
2. *60mm mushroom available only in red, green, black, and yellow.
3. For nameplates and accessories, see page 680 and 683.
4. For dimensions, see page 685.
5. For contact assembly part numbers, see page 685.
6. All assembled part numbers in catalog include standard spring-up Finger-Safe (HW-U...) contacts.
7. Operator only models include operator plus button.
8. Additional contact configurations available (up to 6 total contacts).

Switches & Pilot Devices

Signaling Lights

Relays & Sockets

Timers

Contactors

Terminal Blocks

Circuit Breakers

Part Number Structure

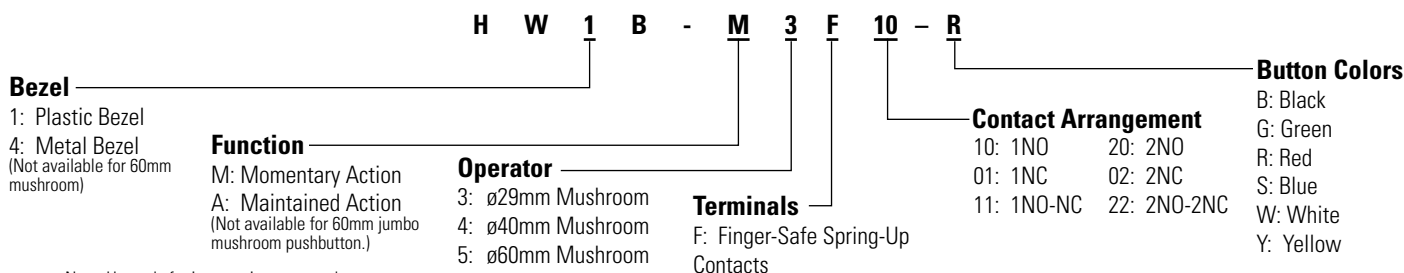

Note: Use only for interpreting part numbers. Do not use for developing part numbers.

Non-Illuminated Mushroom Head Pushbuttons (Replacement Parts)

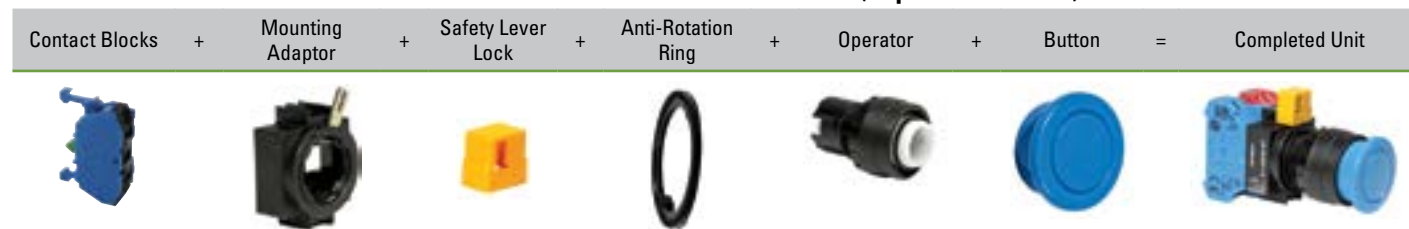

Contact Blocks

| Style | Contacts | 1NO | 1NC |
|-------|--------------------------------|------------------------|------------------------|
| | Finger-Safe Spring-Up Terminal | HW-U10-F | HW-U01-F |
| | | HW-U10R-F (early make) | HW-U01R-F (late break) |
| | Dummy Block | HW-DB | |

Contact Block Mounting Adaptor

| Style | Part Number |
|-------|-------------|
| | HW-CB2C |

- Used to mount contact blocks to operator.
- IDEC strongly recommends using the safety lever lock to prevent heavy vibration or maintenance personnel from inadvertently unlocking contacts.

Safety Lever Lock

| Style | Part Number |
|-------|-------------|
| | HW9Z-LS |

Anti-Rotation Ring

| Appearance | Part Number |
|------------|-------------|
| | HW9Z-RL |

Operators

| Style | Plastic Bezel | Metal Bezel | |
|----------------------------------|---------------|-------------|----------|
| ø29mm Mushroom ø40mm Mushroom | Momentary | HW1B-MOL | HW4B-MOL |
| | Maintained | HW1B-AOL | HW4B-AOL |
| ø60mm Jumbo Mushroom | Momentary | HW1B-M5-⊙* | - |

- *60mm mushroom operator includes non-removable button (available in red, black, green and yellow).
- For nameplates and accessories, see page 680 and 683.
- For dimensions, see page 685.

Buttons

| Style | Part Number |
|--------------------|-------------|
| ø29mm Mushroom Cap | HW1A-B3-⊙ |
| ø40mm Mushroom Cap | HW1A-B4-⊙ |

- In place of ⊙, specify the Button Color Code from table.

⊙ Button Color Code

| Color | Code | Color | Code |
|-------|------|--------|------|
| Black | B | Blue | S |
| Green | G | White | W |
| Red | R | Yellow | Y |

- HW1B-M5 available only in black, red, green and yellow.

Non-Illuminated Square Pushbuttons (Assembled)



| Function | Contacts | Square Flush | Square Extended |
|------------|----------------------|---------------|-----------------|
| | | Plastic Bezel | Plastic Bezel |
| Momentary | <i>Operator Only</i> | HW2B-M1-① | HW2B-M2-① |
| | 1NO | HW2B-M1F10-① | HW2B-M2F10-① |
| | 1NC | HW2B-M1F01-① | HW2B-M2F01-① |
| | 1NO-1NC | HW2B-M1F11-① | HW2B-M2F11-① |
| | 2NO | HW2B-M1F20-① | HW2B-M2F20-① |
| | 2NC | HW2B-M1F02-① | HW2B-M2F02-① |
| | 2NO-2NC | HW2B-M1F22-① | HW2B-M2F22-① |
| Maintained | <i>Operator Only</i> | HW2B-A1-① | HW2B-A2-① |
| | 1NO | HW2B-A1F10-① | HW2B-A2F10-① |
| | 1NC | HW2B-A1F01-① | HW2B-A2F01-① |
| | 1NO-1NC | HW2B-A1F11-① | HW2B-A2F11-① |
| | 2NO | HW2B-A1F20-① | HW2B-A2F20-① |
| | 2NC | HW2B-A1F02-① | HW2B-A2F02-① |
| | 2NO-2NC | HW2B-A1F22-① | HW2B-A2F22-① |

① **Button Color Code**

| Color | Code |
|--------|------|
| Black | B |
| Green | G |
| Red | R |
| Blue | S |
| White | W |
| Yellow | Y |



1. In place of ①, specify the Button Color Code from table.
2. For nameplates and accessories, see page 680 and 683.
3. For dimensions, see page 685.
4. For contact assembly part numbers, see page 685.
5. Square pushbuttons available in plastic bezel only.
6. All assembled part numbers in catalog include finger-safe spring-up (HW-U...) contacts.
7. Operator only model includes operator and button.
8. Additional contact configurations available (up to 6 total contacts).

Part Number Structure



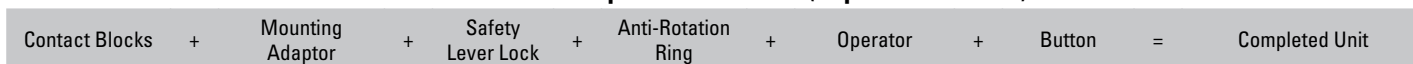

 Note: Use only for interpreting part numbers. Do not use for developing part numbers.

Non-Illuminated Square Pushbuttons (Replacement Parts)



Contact Blocks

| Style | Contacts | 1NO | 1NC |
|---|--------------------------------|------------------------|------------------------|
|  | Finger-Safe Spring-Up Terminal | HW-U10-F | HW-U01-F |
| | | HW-U10R-F (early make) | HW-U01R-F (late break) |
|  | Dummy Block | HW-DB | |

Contact Block Mounting Adaptor

| Style | Part Number |
|---|-------------|
|  | HW-CB2C |

-  1. Used to mount contact blocks to operator.
2. IDEC strongly recommends using the safety lever lock to prevent heavy vibration or maintenance personnel from inadvertently unlocking contacts.

Safety Lever Lock

| Style | Part Number |
|--|-------------|
|  | HW9Z-LS |

Anti-Rotation Ring

| Appearance | Part Number |
|---|-------------|
|  | HW9Z-RL |

-  Use with notched panel cutout to prevent unit rotation.

Operators

| Style | | Plastic Bezel |
|---|------------|---------------|
|  | Momentary | HW2B-M0 |
| | Maintained | HW2B-A0 |

-  2. For nameplates and accessories, see pages 680 and 683.
3. For dimensions, see page 685.

Buttons

| Style | Part Number |
|--|-------------|
| Square Flush  | HW2A-B1-Ⓢ |
| Square Extended  | HW2A-B2-Ⓢ |

-  1. In place of Ⓢ, specify the Button Color Code from table.

Ⓢ Button Color Code

| Color | Code | Color | Code |
|-------|------|--------|------|
| Black | B | Blue | S |
| Green | G | White | W |
| Red | R | Yellow | Y |

Non-Illuminated E-Stop Pushbuttons (Assembled)



| Contacts | Ø29mm Head Pushlock Turn Reset | | Ø40mm Head Pushlock Turn Reset | |
|----------------------|--------------------------------|---------------|--------------------------------|---------------|
| | Plastic Bezel | Metal Bezel | Plastic Bezel | Metal Bezel |
| <i>Operator Only</i> | HW1B-V3Ⓢ† | HW4B-V3Ⓢ† | HW1B-V4Ⓢ† | HW4B-V4Ⓢ† |
| 1NO | HW1B-V3F10-Ⓢ† | HW4B-V3F10-Ⓢ† | HW1B-V4F10-Ⓢ† | HW4B-V4F10-Ⓢ† |
| 1NC | HW1B-V3F01-Ⓢ† | HW4B-V3F01-Ⓢ† | HW1B-V4F01-Ⓢ† | HW4B-V4F01-Ⓢ† |
| 1NO-1NC | HW1B-V3F11-Ⓢ† | HW4B-V3F11-Ⓢ† | HW1B-V4F11-Ⓢ† | HW4B-V4F11-Ⓢ† |
| 2NO | HW1B-V3F20-Ⓢ† | HW4B-V3F20-Ⓢ† | HW1B-V4F20-Ⓢ† | HW4B-V4F20-Ⓢ† |
| 2NC | HW1B-V3F02-Ⓢ† | HW4B-V3F02-Ⓢ† | HW1B-V4F02-Ⓢ† | HW4B-V4F02-Ⓢ† |



| Contacts | Ø40mm Head EMO Pushlock Turn Reset | | Ø40mm Head Pushlock Key Reset | |
|----------------------|------------------------------------|---------------------|-------------------------------|---------------|
| | Plastic Bezel | Metal Bezel | Plastic Bezel | Metal Bezel |
| <i>Operator Only</i> | HW1B-V4R-EMO-2* | HW4B-V4R-EMO-2* | HW1B-X4R* | HW4B-X4R* |
| 1NO | HW1B-V4F10-R-EMO-2* | HW4B-V4F10-R-EMO-2* | HW1B-X4F10-R* | HW4B-X4F10-R* |
| 1NC | HW1B-V4F01-R-EMO-2* | HW4B-V4F01-R-EMO-2* | HW1B-X4F01-R* | HW4B-X4F01-R* |
| 1NO-1NC | HW1B-V4F11-R-EMO-2* | HW4B-V4F11-R-EMO-2* | HW1B-X4F11-R* | HW4B-X4F11-R* |
| 2NO | HW1B-V4F20-R-EMO-2* | HW4B-V4F20-R-EMO-2* | HW1B-X4F20-R* | HW4B-X4F20-R* |
| 2NC | HW1B-V4F02-R-EMO-2* | HW4B-V4F02-R-EMO-2* | HW1B-X4F02-R* | HW4B-X4F02-R* |



- * Available in Red only.
- † Available in red or yellow. Insert color code in place of Ⓢ (R: Red, Y: Yellow).
- For accessories, see page 683.
- For dimensions, see page 685.
- For nameplates and shrouds, see page 685.
- For contact assembly part numbers, see page 685.
- All HW series E-stops comply with EN60947-5-5, the IEC "E-Stop Addendum to the Low Voltage Directive," this includes "tamper proof" operation whereby a change of contact state is not possible by "teasing" or "floating" the operator.
- All assembled part numbers in catalog include standard finger-safe spring-up (HW-U...) contacts.
- Operator only models include operator and button.
- Additional contact configurations available (up to 6 total contacts).

| Contacts | ø60mm Head Pushlock Turn Reset |
|----------------------|--------------------------------|
| | Plastic Bezel |
| <i>Operator Only</i> | HW1B-V5R* |
| 1NO | HW1B-V5F10-R* |
| 1NC | HW1B-V5F01-R* |
| 1NO-1NC | HW1B-V5F11-R* |
| 2NO | HW1B-V5F20-R* |
| 2NC | HW1B-V5F02-R* |

Part Number Structure



Non-Illuminated E-Stop Pushbuttons (Replacement Parts)



Contact Blocks

| Style | Contacts | 1NO | 1NC |
|-------|--------------------------------|------------------------|------------------------|
| | Finger-Safe Spring-Up Terminal | HW-U10-F | HW-U01-F |
| | | HW-U10R-F (early make) | HW-U01R-F (late break) |
| | Dummy Block | HW-DB | |

Safety Lever Lock

| Style | Part Number |
|-------|-------------|
| | HW9Z-LS |

Anti-Rotation Ring

| Appearance | Part Number |
|------------|-------------|
| | HW9Z-RL |

Note: Use with notched panel cutout to prevent unit rotation.

Contact Block Mounting Adaptor

| Style | Part Number |
|-------|-------------|
| | HW-CB2C |

- Used to mount contact blocks to operator.
- IEDEC strongly recommends using the safety lever lock to prevent heavy vibration or maintenance personnel from inadvertently unlocking contacts.

Operators

| Style | Plastic | Metal |
|---|---------|-------------------------------|
| ø29mm Head Pushlock Turn Reset | red | HW1B-V3R HW4B-V3R |
| | yellow | HW1B-V3Y HW4B-V3Y |
| ø40mm Head Pushlock Turn Reset | red | HW1B-V4R HW4B-V4R |
| | yellow | HW1B-V4Y HW4B-V4Y |
| ø40mm Head EMO Pushlock Turn Reset* | | HW1B-V4R-EMO-2 HW4B-V4R-EMO-2 |
| ø40mm Head Pushlock Key Reset* | | HW1B-X4R HW4B-X4R |
| ø60mm Head Pushlock Turn Reset* | | HW1B-V5R - |

- * Available in red only.
- All E-Stop buttons are not removable from the operator.

Note: Determine mounting centers to ensure proper spacing.

Push Pull & Unibody E-Stop Pushbuttons (Assembled)



Switches & Pilot Devices

Signaling Lights

Relays & Sockets

Timers

Contactors

Terminal Blocks

Circuit Breakers

| Contacts | ø40mm Head Push-Pull | |
|------------------------|----------------------|---------------|
| | Plastic Bezel | Metal Bezel |
| Operator Only (Red) | HW1B-Y2R | HW4B-Y2R |
| Operator Only (Yellow) | HW1B-Y2Y | HW4B-Y2Y |
| 1NO | HW1B-Y2F10-Ⓢ† | HW4B-Y2F10-Ⓢ† |
| 1NC | HW1B-Y2F01-Ⓢ† | HW4B-Y2F01-Ⓢ† |
| 1NO-1NC | HW1B-Y2F11-Ⓢ† | HW4B-Y2F11-Ⓢ† |
| 2NC | HW1B-Y2F02-Ⓢ† | HW4B-Y2F02-Ⓢ† |
| 2NO | HW1B-Y2F20-Ⓢ† | HW4B-Y2F20-Ⓢ† |

| Contacts | ø40mm Unibody Pushlock Turn Reset* |
|----------|------------------------------------|
| | Plastic Bezel |
| 1NO-1NC | HW1E-BV4F11-R |
| 2NC | HW1E-BV4F02-R |
| 1NO-2NC* | HW1E-BV412R-TK2093-1 |



* NO contact is used as a monitoring contact

| Contacts | Unibody Illuminated E-Stops* |
|-------------------------------------|------------------------------|
| | LED |
| 1NO-1NC | HW1E-LV4F11QD-R-Ⓢ |
| 2NC | HW1E-LV4F02QD-R-Ⓢ |
| 2NC (with push-on illumination) | HW1E-TV4F02QD-R-Ⓢ |
| 1NO-1NC (with push-on illumination) | HW1E-TV4F11QD-R-Ⓢ |



- * Available in Red only.
- † Available in red or yellow. Insert color code in place of Ⓢ (R: Red, Y: Yellow).
- In place of Ⓢ, specify Full Voltage LED Code.
- With single unit construction, the positive action contacts are integrated in the body of the switch. This provides an extra degree of safety and reliability for critical emergency stop functions.
- In the illuminated version, the light is independent of the switch action (except push-on LED model).
- For accessories, see page 683.
- For dimensions, see page 685.
- For nameplates and shrouds, see page 683.
- For contact assembly part numbers, see page 683.
- All HW Series E-Stop operators include non-removable color caps.
- All HW series E-Stops comply with EN60947-5-5, the IEC "E-Stop Addendum to the Low Voltage Directive," this includes "tamper proof" operation whereby a change of contact state is not possible by "teasing" or "floating" the operator.
- All HW series E-Stop switches comply with SEMI S2 standards.
- All assembled part numbers in catalog include standard finger-safe spring-up (HW-U...) contacts.
- Additional contact configurations available (up to 6 total contacts).

Ⓢ Full Voltage LED Code

| Voltage | Code |
|----------|------|
| 6VAC/DC | 6V |
| 12VAC/DC | 12V |
| 24VAC/DC | 24V |
| 120V AC | 120V |
| 240V AC | 240V |

Terminal Numbering (Unibody only)

| Models | Terminal Number |
|------------------|------------------------|
| 1NO-1NC | NO = 13/14, NC = 11/12 |
| 2NC | NC = 11/12, NC = 21/22 |
| HW1E-L HW1E-T | LED + = X2, LED - = X1 |

Part Number Structure



Note: Use only for interpreting part numbers. Do not use for developing part numbers.

Illuminated & Non-Illuminated E-Stop Pushbuttons (Replacement Parts)



Contact Blocks

| Style | Contacts | 1NO | 1NC |
|-------|--------------------------------|------------------------|------------------------|
| | Finger-Safe Spring-Up Terminal | HW-U10-F | HW-U01-F |
| | | HW-U10R-F (early make) | HW-U01R-F (late break) |
| | Dummy Block | HW-DB | |

- There are no replacement parts for the HW1E unibody E-Stop.
- For illuminated unibody E-Stop, see page 685 for replacement lens.

Contact Block Mounting Adaptor

| Style | Part Number |
|-------|-------------|
| | HW-CB2C |

- Used to mount contact blocks to operator.
- IEDEC strongly recommends using the safety lever lock to prevent heavy vibration or maintenance personnel from inadvertently unlocking contacts.

Safety Lever Lock

| Style | Part Number |
|-------|-------------|
| | HW9Z-LS |

Anti-Rotation Ring

| Appearance | Part Number |
|------------|-------------|
| | HW9Z-RL |

Use with notched panel cutout to prevent unit rotation.

Operators

| Style | | Part Number |
|----------------------|---------|-------------|
| ø40mm Head Push-Pull | Plastic | HW1B-Y2R |
| | Metal | HW4B-Y2R |
| | Plastic | HW1B-Y2Y |
| | Metal | HW4B-Y2Y |

All E-Stop Buttons are not removable from the operator.

E-Stop Stations



| | 29mm Pushlock Turn Reset | | 40mm Pushlock Turn Reset | |
|----------|--------------------------|-----------------|--------------------------|-----------------|
| Contacts | Plastic Bezel | Metal Bezel | Plastic Bezel | Metal Bezel |
| 1NO-1NC | FB1W-HW1B-V311R | FB1W-HW4B-V311R | FB1W-HW1B-V411R | FB1W-HW4B-V411R |
| 2NC | FB1W-HW1B-V302R | FB1W-HW4B-V302R | FB1W-HW1B-V402R | FB1W-HW4B-V402R |



| | 40mm Push-Pull Reset | | 40mm Pushlock Key Reset | |
|----------|----------------------|-----------------|-------------------------|-----------------|
| Contacts | Plastic Bezel | Metal Bezel | Plastic Bezel | Metal Bezel |
| 1NO-1NC | FB1W-HW1B-Y211R | FB1W-HW4B-Y211R | FB1W-HW1B-X411R | FB1W-HW4B-X411R |
| 2NC | FB1W-HW1B-Y202R | FB1W-HW4B-Y202R | FB1W-HW1B-X402R | FB1W-HW4B-X402R |



| | 40mm EMO Pushlock Turn Reset | |
|----------|------------------------------|-----------------------|
| Contacts | Plastic Bezel | Metal Bezel |
| 1NO-1NC | FB1W-HW1B-V411R-EMO-2 | FB1W-HW4B-V411R-EMO-2 |
| 2NC | FB1W-HW1B-V402R-EMO-2 | FB1W-HW4B-V402R-EMO-2 |

- 1. Maximum of two contact blocks.
- 2. Box is supplied with yellow top and black bottom only.

Jumbo Dome Pilot Lights



Plastic Bezel

Actual Size



| | | | |
|------------|-----|---------------------------|------------|
| Jumbo Dome | LED | Operator Only | HW1P-500 |
| | | Full Voltage 24V AC/DC | HW1P-504-Ⓢ |

- 1. In place of Ⓢ, specify the Lens/LED Color Code.
- 2. Spring-Up terminals with 24V LED.
- 3. For nameplates and accessories, see page 680 and 683.
- 4. For dimensions, see page 685.

Ⓢ Lens/LED Color Code

| Color | Code |
|--------|------|
| Amber | A |
| Green | G |
| Red | R |
| Blue | S |
| White | W |
| Yellow | Y |



Jumbo Dome Replacement Parts

| Item | Appearance | Description | Part Number |
|--------------------|------------|--------------------|-------------|
| Lens | | Polycarbonate Lens | HW1A-P5Ⓢ |
| LED Diffusing Lens | | | HW9Z-PP5C |
| LED Lamps | | LED Lamp | LSTDB-2Ⓢ |

- 1. In place of Ⓢ, specify the Lens/LED Color Code.
- 2. Use white LED for yellow lens.

Lamp Ratings

| | Part Number | Operating Voltage | Rated Current | Power Consumption |
|-----|-------------|-------------------|---------------|-------------------|
| LED | LSTDB-2 | 24V AC/DC ±10% | 15mA | 0.36W |



Pilot Lights (Assembled)



| | | Round Flush | | Dome | |
|------------------|---------|---------------|---------------|---------------|---------------|
| | | Plastic Bezel | Metal Bezel | Plastic Bezel | Metal Bezel |
| Operator Only | | HW1P-1FQ0-② | HW4P-1FQ0-② | HW1P-2FQ0-② | HW4P-2FQ0-② |
| Full Voltage | | HW1P-1FQD-②-③ | HW4P-1FQD-②-③ | HW1P-2FQD-②-③ | HW4P-2FQD-②-③ |
| Transformer | 120V AC | HW1P-1FH2D-② | HW4P-1FH2D-② | HW1P-2FH2D-② | HW4P-2FH2D-② |
| | 240V AC | HW1P-1FM4D-② | HW4P-1FM4D-② | HW1P-2FM4D-② | HW4P-2FM4D-② |
| | 480V AC | HW1P-1FT8D-② | HW4P-1FT8D-② | HW1P-2FT8D-② | HW4P-2FT8D-② |
| DC-DC Converter* | 110V DC | HW1P-1D2D-② | — | HW1P-2D2D-② | — |



| | | Square Flush |
|------------------|---------|---------------|
| | | Plastic Bezel |
| Operator Only | | HW2P-1FQ0-② |
| Full Voltage | | HW2P-1FQD-②-③ |
| Transformer | 120V AC | HW2P-1FH2D-② |
| | 240V AC | HW2P-1FM4D-② |
| | 480V AC | HW2P-1FT8D-② |
| DC-DC Converter* | 110V DC | HW2P-1D2D-② |

 * DC-DC converter voltage input from 90-140V DC.

② Lens/LED Color Code

| Color | Code |
|--------|------|
| Amber | A |
| Green | G |
| Red | R |
| Blue | S |
| White | W |
| Yellow | Y |

③ LED Full Voltage Code

| Voltage | Code |
|----------|------|
| 6VAC/DC | 6V |
| 12VAC/DC | 12V |
| 24VAC/DC | 24V |
| 120V AC | 120V |
| 240V AC | 240V |



1. In place of ②, specify the Lens/LED Color Code from table below.
2. In place of ③ specify the Full Voltage Code from table below.
3. For nameplates and accessories, see page 680 and 683.
4. For dimensions, see page 685.
5. **Pilot lights do not come with anti-rotation ring.**
6. Operator models come with operator and lens.
7. **Yellow pilot light comes with white LED.**

Part Number Structure



Note: Use only for interpreting part numbers. Do not use for developing part numbers.

Pilot Lights (Replacement Parts)



(not applicable for full voltage units)

Transformer Units

| Style | Voltage | Part Number |
|------------------------|----------|-------------|
| | 120V AC | HW-FH20 |
| | 240V AC | HW-FM40 |
| | 480V AC | HW-FT80 |
| (6V secondary voltage) | 110V DC† | HW-RD0* |

1. *DC-DC converter can only be used with HW1P-100 and HW2P-100 operators
2. † DC-DC converter voltage input from 90-140V DC.

LED Lamps

| Style | Voltage | Part Number |
|-------|-----------|-------------|
| | 6V AC/DC | LSTD-6Ⓞ |
| | 12V AC/DC | LSTD-1Ⓞ |
| | 24V AC/DC | LSTD-2Ⓞ |
| | 120V AC | LSTD-H2Ⓞ |
| | 240V AC | LSTD-M4Ⓞ |

1. In place of Ⓞ, specify the LED Color Code.
2. The LED contains a current-limiting resistor and reverse polarity protection diodes.

② LED Color Code

| Color | Code | Color | Code |
|-------|------|-------|------|
| Amber | A | Blue | S |
| Green | G | White | W |
| Red | R | | |

For yellow lens use white LED.

Operators

| Style | Type | Plastic Bezel | Metal Bezel |
|------------------|--------------|-------------------------------|-------------|
| Round Flush | Full Voltage | Finger-Safe | HW1P-1FQ0 |
| | Transformer | Finger-Safe | HW1P-10 |
| | | Used for DC-DC converter only | HW1P-100 |
| Dome | Full Voltage | Finger-Safe | HW1P-2FQ0 |
| | Transformer | Finger-Safe | HW1P-20 |
| | | Used for DC-DC converter only | HW2P-100 |
| Square Flush | Full Voltage | Finger-Safe | HW2P-1FQ0 |
| | Transformer | Finger-Safe | HW2P-10 |
| | | Used for DC-DC converter only | HW2P-100 |

1. Transformer type requires separate transformer & LED. Must select correct transformer bases. Use 6V LEDs.
2. Full voltage type only requires LED.

Lenses

| Style | Part Number |
|------------------|-------------|
| Round/Flush | HW1A-P1-Ⓞ |
| Dome | HW1A-P2-Ⓞ |
| Square/Flush | HW2A-P1-Ⓞ |

In place of Ⓞ, specify the Lens Color Code.

③ Lens Color Code

| Color | Code |
|--------|------|
| Amber | A |
| Green | G |
| Red | R |
| Blue | S |
| White | W |
| Yellow | Y |

For yellow lens use white LED.

Illuminated Round Pushbuttons (Assembled)



Illuminated Full Voltage Pushbuttons



| Contacts | Flush | | Extended | | Extended w/ Full Shroud | |
|---|------------------|------------------|------------------|------------------|-------------------------|-------------------|
| | Plastic Bezel | Metal Bezel | Plastic Bezel | Metal Bezel | Plastic Bezel | Metal Bezel |
| Momentary Operator Only 1NO 1NC 1NO-1NC 2NO | HW1L-M1-② | HW4L-M1-② | HW1L-M2-② | HW4L-M2-② | HW1L-MF2-② | HW4L-MF2-② |
| | HW1L-M1F10QD-②-③ | HW4L-M1F10QD-②-③ | HW1L-M2F10QD-②-③ | HW4L-M2F10QD-②-③ | HW1L-MF2F10QD-②-③ | HW4L-MF2F10QD-②-③ |
| | HW1L-M1F01QD-②-③ | HW4L-M1F01QD-②-③ | HW1L-M2F01QD-②-③ | HW4L-M2F01QD-②-③ | HW1L-MF2F01QD-②-③ | HW4L-MF2F01QD-②-③ |
| | HW1L-M1F11QD-②-③ | HW4L-M1F11QD-②-③ | HW1L-M2F11QD-②-③ | HW4L-M2F11QD-②-③ | HW1L-MF2F11QD-②-③ | HW4L-MF2F11QD-②-③ |
| | HW1L-M1F20QD-②-③ | HW4L-M1F20QD-②-③ | HW1L-M2F20QD-②-③ | HW4L-M2F20QD-②-③ | HW1L-MF2F20QD-②-③ | HW4L-MF2F20QD-②-③ |
| Maintained Operator Only 1NO 1NC 1NO-1NC 2NO | HW1L-A1-② | HW4L-A1-② | HW1L-A2-② | HW4L-A2-② | HW1L-AF2-② | HW4L-AF2-② |
| | HW1L-A1F10QD-②-③ | HW4L-A1F10QD-②-③ | HW1L-A2F10QD-②-③ | HW4L-A2F10QD-②-③ | HW1L-AF2F10QD-②-③ | HW4L-AF2F10QD-②-③ |
| | HW1L-A1F01QD-②-③ | HW4L-A1F01QD-②-③ | HW1L-A2F01QD-②-③ | HW4L-A2F01QD-②-③ | HW1L-AF2F01QD-②-③ | HW4L-AF2F01QD-②-③ |
| | HW1L-A1F11QD-②-③ | HW4L-A1F11QD-②-③ | HW1L-A2F11QD-②-③ | HW4L-A2F11QD-②-③ | HW1L-AF2F11QD-②-③ | HW4L-AF2F11QD-②-③ |
| | HW1L-A1F20QD-②-③ | HW4L-A1F20QD-②-③ | HW1L-A2F20QD-②-③ | HW4L-A2F20QD-②-③ | HW1L-AF2F20QD-②-③ | HW4L-AF2F20QD-②-③ |

Illuminated Transformer Pushbuttons



| Contacts | Flush | | Extended | | Extended w/ Full Shroud | |
|---|-----------------|-----------------|-----------------|-----------------|-------------------------|------------------|
| | Plastic Bezel | Metal Bezel | Plastic Bezel | Metal Bezel | Plastic Bezel | Metal Bezel |
| Momentary Operator Only 1NO-1NC 2NO | HW1L-M1-② | HW4L-M1-② | HW1L-M2-② | HW4L-M2-② | HW1L-MF2-② | HW4L-MF2-② |
| | HW1L-M1F11-③D-② | HW4L-M1F11-③D-② | HW1L-M2F11-③D-② | HW4L-M2F11-③D-② | HW1L-MF2F11-③D-② | HW4L-MF2F11-③D-② |
| | HW1L-M1F20-③D-② | HW4L-M1F20-③D-② | HW1L-M2F20-③D-② | HW4L-M2F20-③D-② | HW1L-MF2F20-③D-② | HW4L-MF2F20-③D-② |
| Maintained Operator Only 1NO-1NC 2NO | HW1L-A1-② | HW4L-A1-② | HW1L-A2-② | HW4L-A2-② | HW1L-AF2-② | HW4L-AF2-② |
| | HW1L-A1F11-③D-② | HW4L-A1F11-③D-② | HW1L-A2F11-③D-② | HW4L-A2F11-③D-② | HW1L-AF2F11-③D-② | HW4L-AF2F11-③D-② |
| | HW1L-A1F20-③D-② | HW4L-A1F20-③D-② | HW1L-A2F20-③D-② | HW4L-A2F20-③D-② | HW1L-AF2F20-③D-② | HW4L-AF2F20-③D-② |

- In place of ②, specify Lens/LED Color Code from table.
- In place of ③ specify Voltage Code from table.
- Light independent of switch position.
- For replacement part numbers, see page 651.
- For nameplates and accessories, see page 680 and 683.
- For dimensions, see page 685.
- For contact assembly part numbers, see page 685.
- Full voltage and transformer models use the same operator.
- Additional contact configurations available (up to 6 total contacts).
- 10. Yellow pushbutton comes with white LED.**

② Lens/LED Color Code

| Color | Code |
|--------|------|
| Amber | A |
| Green | G |
| Red | R |
| Blue | S |
| White | W |
| Yellow | Y |



Yellow LED not available. Use white LED for yellow lens.

③ Voltage Code

| Full Voltage Models | | Transformer Models | |
|---------------------|------|--------------------|------|
| Voltage | Code | Voltage | Code |
| 6V AC/DC | 6V | 120V AC | H2 |
| 12V AC/DC | 12V | 240V AC | M4 |
| 24V AC/DC | 24V | 480V AC | T8 |
| 120V AC | 120V | | |
| 240V AC | 240V | | |

Part Number Structure



Illuminated Round Pushbuttons (Replacement Parts)



Note: *Transformer not needed with full voltage models.

Lamp Circuit Components

| Style | Description | Terminals | Part Number |
|-------|---|-------------|----------------------------------|
| | For use with HW-CBL on all illuminated pushbutton units. One required for each deck (pair) of contacts. | | HW-LH3 |
| | For use with odd number of contacts. | Finger-Safe | HW-DA1FBN |
| | For use with even number of contacts. | Finger-Safe | TW-DA1FB |
| | 120VAC 240VAC 480VAC | Finger-Safe | TW-F126B TW-F246B TW-F486B |
| | 110VDC | | HW-L16D |

- *With spring-up terminals - to use spring-up terminal type, must use transformer type operator designed for spring-up transformer.
- ** DC-DC converter voltage input from 90-140V DC.

Operators

| Style | | Plastic Bezel | Metal Bezel |
|---------------------------|--|---------------|-------------|
| Round Flush/Extended | | HW1L-M0 | HW4L-M0 |
| | | HW1L-A0 | HW4L-A0 |
| Extended with Full Shroud | | HW1L-MF0 | HW4L-MF0 |
| | | HW1L-AF0 | HW4L-AF0 |

Contact Blocks

| Style | Contacts | 1NO | 1NC |
|-------|--------------------------------|------------------------------------|------------------------------------|
| | Finger-Safe Spring-Up Terminal | HW-U10-F HW-U10R-F (early make) | HW-U01-F HW-U01R-F (late break) |

- All assembled part numbers in catalog include standard finger-safe spring-up (HW-U...) contacts.

Contact Block Mounting Adaptor

| Style | Part Number |
|-------|-------------|
| | HW-CBL |

- Used to mount contact blocks to operator (first pair only).
- IEDEC strongly recommends using the safety lever lock to prevent heavy vibration or maintenance personnel from inadvertently unlocking contacts.

Safety Lever Lock

| Style | Part Number |
|-------|-------------|
| | HW9Z-LS |

Lenses

| Style | Part Number |
|----------------|-------------|
| Round Flush | HW1A-L1-⊙ |
| Round Extended | |
| | HW1A-L2-⊙ |

- In place of ⊙, specify the Lens Color Code from previous page.

Anti-Rotation Ring

| Appearance | Part Number |
|------------|-------------|
| | HW9Z-RL |

- Use with notched panel cutout to prevent unit rotation.

LED Lamps

| Style | Voltage | Part Number |
|-------|-----------|-------------|
| | 6V AC/DC | LSTD-6⊙ |
| | 12V AC/DC | LSTD-1⊙ |
| | 24V AC/DC | LSTD-2⊙ |
| | 120V AC | LSTD-H2⊙ |
| | 240V AC | LSTD-M4⊙ |

- In place of ⊙, specify the LED Color Code.
- The LED contains a current-limiting resistor and reverse polarity protection diodes.
- Yellow LED not available, use white LED when using yellow lens.

Illuminated Mushroom & Square Pushbuttons (Assembled)



| | | Contacts | 40mm Mushroom Head | | Square Flush |
|--------------|------------|-----------------------------------|--------------------|------------------|------------------|
| | | | Plastic Bezel | Metal Bezel | Plastic Bezel |
| Full Voltage | Momentary | <i>Operator Only</i> [†] | HW1L-M4-② | HW4L-M4-② | HW2L-M1-② |
| | | 1NO | HW1L-M4F10QD-②-③ | HW4L-M4F10QD-②-③ | HW2L-M1F10QD-②-③ |
| | | 1NC | HW1L-M4F01QD-②-③ | HW4L-M4F01QD-②-③ | HW2L-M1F01QD-②-③ |
| | | 1NO-1NC | HW1L-M4F11QD-②-③ | HW4L-M4F11QD-②-③ | HW2L-M1F11QD-②-③ |
| | | 2NO | HW1L-M4F20QD-②-③ | HW4L-M4F20QD-②-③ | HW2L-M1F20QD-②-③ |
| | Maintained | <i>Operator Only</i> [†] | HW1L-A4-② | HW4L-A4-② | HW2L-A1-② |
| | | 1NO | HW1L-A4F10QD-②-③ | HW4L-A4F10QD-②-③ | HW2L-A1F10QD-②-③ |
| | | 1NC | HW1L-A4F01QD-②-③ | HW4L-A4F01QD-②-③ | HW2L-A1F01QD-②-③ |
| | | 1NO-1NC | HW1L-A4F11QD-②-③ | HW4L-A4F11QD-②-③ | HW2L-A1F11QD-②-③ |
| | | 2NO | HW1L-A4F20QD-②-③ | HW4L-A4F20QD-②-③ | HW2L-A1F20QD-②-③ |
| Transformer | Momentary | 1NO-1NC | HW1L-M4F11③D-② | HW4L-M4F11③D-② | HW2L-M1F11③D-② |
| | | 2NO | HW1L-M4F20③D-② | HW4L-M4F20③D-② | HW2L-M1F20③D-② |
| | Maintained | 1NO-1NC | HW1L-A4F11③D-② | HW4L-A4F11③D-② | HW2L-A1F11③D-② |
| | | 2NO | HW1L-A4F20③D-② | HW4L-A4F20③D-② | HW2L-A1F20③D-② |



- [†] Full voltage and transformer units use the same operator.
- In place of ②, specify the Lens/LED Color Code from table.
- In place of ③ specify the Voltage Code from table.
- Light independent of switch position
- For nameplates and accessories, see page 680. and 683.
- For dimensions, see page 685.
- For contact assembly part numbers, see page 685.
- Additional contact configurations available (up to 6 total contacts).
- 9. Yellow pushbutton comes with white LED.**

② Lens/LED Color Code

| Color | Code |
|--------|------|
| Amber | A |
| Green | G |
| Red | R |
| Blue | S |
| White | W |
| Yellow | Y* |



- *40mm mushroom lenses not available in yellow.
- Yellow LED not available. Use white LED for yellow lens.

③ Voltage Code

| Full Voltage Models | | Transformer Models | |
|---------------------|------|--------------------|------|
| Voltage | Code | Voltage | Code |
| 6V AC/DC | 6V | 120V AC | H2 |
| 12V AC/DC | 12V | 240V AC | M4 |
| 24V AC/DC | 24V | 480V AC | T8 |
| 120V AC | 120V | | |
| 240V AC | 240V | | |

Part Number Structure

H W 1 L - M 1 F 10 Q D - G - 12V

Bezel
 1: Round Plastic
 2: Square Plastic
 4: Round Metal

Function
 M: Momentary
 A: Maintained

Operator
 1: Square Flush
 4: Mushroom

Contact Arrangement
 10: 1NO
 01: 1NC
 11: 1NO-1NC
 20: 2NO

Illumination Circuit
 Q: Full Voltage
 H2: Transformer 120V AC
 M4: Transformer 240V AC
 T8: Transformer 480V AC

Lens Color
 A: Amber S: Blue
 G: Green W: White
 R: Red Y: Yellow

Voltage
 (full voltage units only)
 6V: 6V AC/DC
 12V: 12V AC/DC
 24V: 24V AC/DC
 120V: 120V AC
 240V: 240V AC

Note: Use only for interpreting part numbers. Do not use for developing part numbers.

Illuminated Mushroom & Square Pushbuttons (Replacement Parts)

| | | | | | | | | | | | | | | | | | | |
|--------------|---|----------------|---|-------------|---|----------|---|-------------------|---|-----|---|--------------------|---|----------|---|------|---|----------------|
| Transformer* | + | Contact Blocks | + | Lead Holder | + | Adaptor† | + | Safety Lever Lock | + | LED | + | Anti-Rotation Ring | + | Operator | + | Lens | = | Completed Unit |
|--------------|---|----------------|---|-------------|---|----------|---|-------------------|---|-----|---|--------------------|---|----------|---|------|---|----------------|

*Transformer not needed with full voltage models.

Lamp Circuit Components

| Style | Description | Terminals | Part Number |
|---|---|-------------|----------------------------------|
| Lead Holder | For use with HW-CBL on all illuminated pushbutton units. One required for each deck (pair) of contacts. | | HW-LH3 |
| Dummy Block with Full Voltage Adaptor | For use with odd number of contacts. | Finger-Safe | HW-DA1FBN |
| Full Voltage Adaptor | For use with even number of contacts. | Finger-Safe | TW-DA1FB |
| Transformer Unit (6V secondary voltage) | 120VAC 240VAC 480VAC | Finger-Safe | TW-F126B TW-F246B TW-F486B |
| DC-DC Converter | 110VDC | | HW-L16D |

- *With spring-up terminals - to use spring-up terminal type, must use transformer type operator designed for spring-up transformer.
- ** DC-DC converter voltage input from 90-140V DC.

Operators

| Style | Plastic Bezel | Metal Bezel |
|----------------|---------------|-------------------|
| ø40mm Mushroom | Momentary | HW1L-M0L HW4L-M0L |
| | Maintained | HW1L-A0L HW4L-A0L |
| Square | Momentary | HW2L-M0 |
| | Maintained | HW2L-A0 |

Contact Blocks

| Style | Contacts | 1NO | 1NC |
|--------------------------------|----------|------------------------------------|------------------------------------|
| Finger-Safe Spring-Up Terminal | | HW-U10-F HW-U10R-F (early make) | HW-U01-F HW-U01R-F (late break) |

- All assembled part numbers in catalog include standard finger-safe spring-up contacts (HW-U...).

Contact Block Mounting Adaptor

| Style | Part Number |
|-------|-------------|
| | HW-CBL |

- Used to mount contact blocks to operator (first pair only).
- IDECC strongly recommends using the safety lever lock to prevent heavy vibration or maintenance personnel from inadvertently unlocking contacts.

Anti-Rotation Ring

| Appearance | Part Number |
|------------|-------------|
| | HW9Z-RL |

- Use with notched panel cutout to prevent unit rotation.

Safety Lever Lock

| Style | Part Number |
|-------|-------------|
| | HW9Z-LS |

Lenses

| Style | Part Number |
|---------------------|-------------|
| ø40mm Mushroom Lens | ALW4BLU-⊙* |
| Square Flush | HW2A-L1-⊙ |

- In place of ⊙, specify the Lens Color Code.
- *Mushroom lens not available in yellow.

LED Lamps

| Style | Voltage | Part Number |
|-------|-----------|-------------|
| LED | 6V AC/DC | LSTD-6⊙ |
| | 12V AC/DC | LSTD-1⊙ |
| | 24V AC/DC | LSTD-2⊙ |
| | 120V AC | LSTD-H2⊙ |
| | 240V AC | LSTD-M4⊙ |

- In place of ⊙, specify the LED Color Code.
- The LED contains a current-limiting resistor and reverse polarity protection diodes.
- Yellow LED not available, use white LED when using yellow lens.

Selector Switches 2-Position (Assembled)



2-Position Selector Switches

| Contact | Mounting | Operator Position | | Handle | Maintained | Spring Return from Right |
|----------------------|------------------|-------------------|------------------|-----------------------|----------------------------|------------------------------|
| | | L | R | | | |
| <i>Operator Only</i> | | | | <i>Knob Lever</i> | <i>HW⊙S-2T HW⊙S-2L</i> | <i>HW⊙S-21T HW⊙S-21L</i> |
| 1NO | 1 | 0 | X | Knob Lever | HW⊙S-2TF10 HW⊙S-2LF10 | HW⊙S-21TF10 HW⊙S-21LF10 |
| 1NO- 1NC | 1 2 | 0 X | X 0 | Knob Lever | HW⊙S-2TF11 HW⊙S-2LF11 | HW⊙S-21TF11 HW⊙S-21LF11 |
| 2NO | 1 2 | 0 0 | X X | Knob Lever | HW⊙S-2TF20 HW⊙S-2LF20 | HW⊙S-21TF20 HW⊙S-21LF20 |
| 2NO- 2NC | 1 2 3 4 | X 0 X 0 | 0 X 0 X | Knob Lever | HW⊙S-2TF22 HW⊙S-2LF22 | HW⊙S-21TF22 HW⊙S-21LF22 |



1. In place of ⊙ enter 1 for plastic bezel or 4 for metal bezel.
2. For nameplates, see page 680.
3. All assembled part numbers in catalog include standard finger-safe spring-up (HW-U...) contacts.
4. Standard color for knob and lever is black.
5. Optional colors available for lever type. Must order in components. See next page for part numbers.
6. Additional contact configurations available (up to 6 total contacts).
7. For Truth Tables see page 693.

⊙ Bezel Type

| Type | Code |
|---------|------|
| Plastic | 1 |
| Metal | 4 |

Part Number Structure

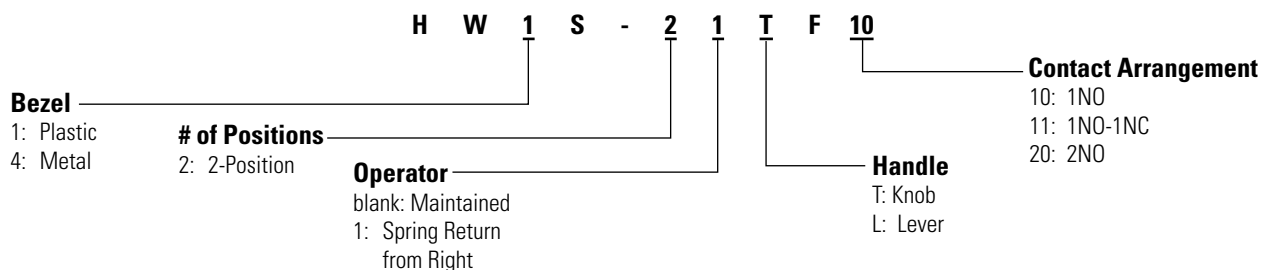

Note: Use only for interpreting part numbers. Do not use for developing part numbers.

Selector Switches 2-Position (Replacement Parts)



Contact Blocks

| Style | Contacts | 1NO | 1NC |
|-------|--------------------|------------------------|------------------------|
| | Finger-Safe | HW-U10-F | HW-U01-F |
| | Spring-Up Terminal | HW-U10R-F (early make) | HW-U01R-F (late break) |
| | Dummy Block | HW-DB | |

Anti-Rotation Ring

| Style | Part Number |
|-------|-------------|
| | HW9Z-RL |

Use with notched panel cutout to prevent unit rotation.

Contact Block Mounting Adaptor

| Style | Part Number |
|-------|-------------|
| | HW-CB2C |

- 1. Used to mount contact blocks to operator (first pair only).
- 2. IDEC strongly recommends using the safety lever lock to prevent heavy vibration or maintenance personnel from inadvertently unlocking contacts.

Operators

| Style | Description | Handle | Plastic Bezel | Metal Bezel |
|-------|--------------------------|--------|---------------|-------------|
| | Maintained | Knob | HW1S-2T | HW4S-2T |
| | | Lever | HW1S-2 | HW4S-2 |
| | Spring Return from Right | Knob | HW1S-21T | HW4S-21T |
| | | Lever | HW1S-21 | HW4S-21 |

- 1. Knob operator comes with black handle.
- 2. To order lever type, lever and inserts must be ordered separately, along with lever operator. See part numbers below.

Safety Lever Lock

| Style | Part Number |
|-------|-------------|
| | HW9Z-LS |

Levers & Inserts

| Style | Part Number |
|-------|-------------|
| | ASWHHL-① |
| | TW-HC1-① |

Standard lever color is black. Standard insert color is white.

① Handle/Insert Color Code

| Color | Code |
|--------|------|
| Black* | B |
| Blue | S |
| Green | G |
| Red | R |
| Yellow | Y |
| White† | W |

- 1. * Lever color inserts not available in black.
- 2. †Lever not available in white.

Selector Switches 3-Position (Assembled)



3-Position Selector Switches

| Contact | Mounting | Operator Position | | | Handle | Maintained | Spring Return from Right | Spring Return from Left | Spring Return Two-Way |
|----------------------|----------|-------------------|---|---|---------------|-----------------------------------|------------------------------------|------------------------------------|------------------------------------|
| | | L | C | R | | | | | |
| | | | | | | | | | |
| <i>Operator Only</i> | | | | | <i>Knob</i> | <i>HW⊙S-3T*</i> <i>HW⊙S-3L</i> | <i>HW⊙S-31T</i> <i>HW⊙S-31L</i> | <i>HW⊙S-32T</i> <i>HW⊙S-32L</i> | <i>HW⊙S-33T</i> <i>HW⊙S-33L</i> |
| 1NO-1NC | 1 | 0 | X | X | Knob Lever | HW⊙S-3TF11 HW⊙S-3LF11 | HW⊙S-31TF11 HW⊙S-31LF11 | HW⊙S-32TF11 HW⊙S-32LF11 | HW⊙S-33TF11 HW⊙S-33LF11 |
| | 2 | 0 | 0 | X | | | | | |
| 2NO | 1 | X | 0 | 0 | Knob Lever | HW⊙S-3TF20 HW⊙S-3LF20 | HW⊙S-31TF20 HW⊙S-31LF20 | HW⊙S-32TF20 HW⊙S-32LF20 | HW⊙S-33TF20 HW⊙S-33LF20 |
| | 2 | 0 | 0 | X | | | | | |
| 2NC | 1 | 0 | X | X | Knob Lever | HW⊙S-3TF02 HW⊙S-3LF02 | HW⊙S-31TF02 HW⊙S-31LF02 | HW⊙S-32TF02 HW⊙S-32LF02 | HW⊙S-33TF02 HW⊙S-33LF02 |
| | 2 | X | X | 0 | | | | | |
| 2NO-1NC | 1 | X | 0 | 0 | Knob | HW⊙S-3JTF21N1 | - | - | - |
| | 2 | 0 | 0 | X | | | | | |
| | 3 | 0 | X | 0 | | | | | |
| 2NO-2NC | 1 | X | 0 | 0 | Knob | HW⊙S-3TF22 | HW⊙S-31TF22 | HW⊙S-32TF22 | HW⊙S-33TF22 |
| | 2 | 0 | 0 | X | | | | | |
| | 3 | 0 | X | X | | | | | |
| | 4 | X | X | 0 | | | | | |
| 2NO-2NC | 1 | 0 | 0 | X | Knob | HW⊙S-3STF22N9 | - | - | - |
| | 2 | X | 0 | 0 | | | | | |
| | 3 | X | X | 0 | | | | | |
| | 4 | 0 | 0 | X | | | | | |
| 4NO | 1 | X | 0 | 0 | Knob | HW⊙S-3TF40 | HW⊙S-31TF40 | HW⊙S-32TF40 | HW⊙S-33TF40 |
| | 2 | 0 | 0 | X | | | | | |
| | 3 | X | 0 | 0 | | | | | |
| | 4 | 0 | 0 | X | | | | | |
| 4NO | 1 | X | 0 | 0 | Knob | HW⊙S-3STF40N2 | - | - | - |
| | 2 | 0 | X | X | | | | | |
| | 3 | X | 0 | 0 | | | | | |
| | 4 | 0 | 0 | X | | | | | |
| 4NC | 1 | 0 | X | X | Knob | HW⊙S-3TF04 | HW⊙S-31TF04 | HW⊙S-32TF04 | HW⊙S-33TF04 |
| | 2 | X | X | 0 | | | | | |
| | 3 | 0 | X | X | | | | | |
| | 4 | X | X | 0 | | | | | |

Ⓢ Bezel Type

| Type | Code |
|---------|------|
| Plastic | 1 |
| Metal | 4 |

- In place of ⊙ enter 1 for plastic bezel or 4 for metal bezel.
- Knob operator includes black knob/lever operator includes black lever.
- * Three position operator is available with three different cams.
HW⊙S-3T: Maintained (standard cam)
HW⊙S-3ST: Maintained (S cam)
HW⊙S-3JT: Maintained (J cam)
- Operator cams are color coded (white=standard cam, red=S cam, black =J cam).
- For nameplates, see page 680.
- For contact assembly part numbers, see page 685
- All assembled part numbers in catalog include standard finger-safe spring-up (HW-U...) contacts.
- Standard color for knob and lever is black.
- Optional colors available for lever type. Must order in components. See next page for part numbers.
- Additional contact configurations available (up to 6 total contacts).
- For Truth Tables see page 693.

Part Number Structure



Selector Switches 3-Position (Replacement Parts)



Contact Blocks

| Style | Contacts | 1NO | 1NC |
|-------|--------------------------------|------------------------|------------------------|
| | Finger-Safe Spring-Up Terminal | HW-U10-F | HW-U01-F |
| | | HW-U10R-F (early make) | HW-U01R-F (late break) |
| | Dummy Block | HW-DB | |

Anti-Rotation Ring

| Style | Part Number |
|-------|-------------|
| | HW9Z-RL |

Use with notched panel cutout to prevent unit rotation.

Operators

| Style | Description | Handle | Plastic Bezel | Metal Bezel |
|-------|---|--------|---------------|-------------|
| | Maintained (standard cam) | Knob | HW1S-3T | HW4S-3T |
| | | Lever | HW1S-3 | HW4S-3 |
| | Maintained (S cam) | Knob | HW1S-3ST | HW4S-3ST |
| | | Knob | HW1S-3JT | HW4S-3JT |
| | Spring Return from Right (standard cam) | Knob | HW1S-31T | HW4S-31T |
| | | Lever | HW1S-31 | HW4S-31 |
| | Spring Return from Left (standard cam) | Knob | HW1S-32T | HW4S-32T |
| | | Lever | HW1S-32 | HW4S-32 |
| | 2-Way Spring Return (standard cam) | Knob | HW1S-33T | HW4S-33T |
| | | Lever | HW1S-33 | HW4S-33 |

- 1. Knob operator comes with black handle.
- 2. Three position knob operator is available with three different cams.
- 3. Operator cams are color coded (white=standard cam, red=S cam, black=J cam).
- 4. To order lever type, lever and inserts must be ordered separately, along with lever operator. See part numbers below.

Contact Block Mounting Adaptor

| Style | Part Number |
|-------|-------------|
| | HW-CB2C |

- 1. Used to mount contact blocks to operator (first pair only).
- 2. IDEC strongly recommends using the safety lever lock to prevent heavy vibration or maintenance personnel from inadvertently unlocking contacts.

Safety Lever Lock

| Style | Part Number |
|-------|-------------|
| | HW9Z-LS |

Levers & Inserts

| Style | Part Number |
|-------|-------------|
| | ASWHHL-⓪ |
| | TW-HC1-⓪ |

Standard lever color is black. Standard insert color is white.

① Handle/Insert Color Code

| Color | Code |
|--------------------|------|
| Black* | B |
| Blue | S |
| Green | G |
| Red | R |
| Yellow | Y |
| White [†] | W |

- 1. * Lever color inserts not available in black.
- 2. [†]Lever not available in white.

Selector Switches 4- & 5-Position (Assembled)



4-Position Selector Switches

| Contact | Mounting | Operator Position | | | | Handle | Maintained |
|---------------|----------|-------------------|---|---|---|---------------|------------------------------|
| | | 1 | 2 | 3 | 4 | | |
| Operator Only | | | | | | Knob Lever | HWⓈS-4T HWⓈS-4L |
| 1NO- 2NC | 1 | X | 0 | 0 | 0 | Knob Lever | HWⓈS-4TF12 HWⓈS-4LF12 |
| | 2 | 0 | X | 0 | 0 | | |
| | 3 | 0 | 0 | X | 0 | | |
| | 4 | 0 | 0 | 0 | 0 | | |
| 1NO- 3NC | 1 | 0 | X | X | X | Knob Lever | HWⓈS-4TF13N6 HWⓈS-4LF13N6 |
| | 2 | 0 | X | 0 | 0 | | |
| | 3 | 0 | 0 | X | 0 | | |
| | 4 | 0 | 0 | 0 | X | | |
| 2NO- 2NC | 1 | X | 0 | 0 | 0 | Knob Lever | HWⓈS-4TF22N3 HWⓈS-4LF22N3 |
| | 2 | 0 | X | 0 | 0 | | |
| | 3 | 0 | 0 | X | 0 | | |
| | 4 | 0 | 0 | 0 | X | | |

5-Position Selector Switch

| Contact | Mounting | Operator Position | | | | | Handle | Maintained |
|---------------|----------|-------------------|---|---|---|---------------|--------------------|------------------------------|
| | | 1 | 2 | 3 | 4 | 5 | | |
| Operator Only | | | | | | Knob Lever | HWⓈS-5T HWⓈS-5L | |
| 2NO- 2NC | 1 | X | 0 | 0 | 0 | 0 | Knob Lever | HWⓈS-5TF22N3 HWⓈS-5LF22N3 |
| | 2 | 0 | X | 0 | 0 | 0 | | |
| | 3 | 0 | 0 | 0 | X | 0 | | |
| | 4 | 0 | 0 | 0 | 0 | X | | |



1. In place of Ⓢ enter 1 for plastic bezel or 4 for metal bezel.
2. Knob operator includes black knob/lever operator includes black lever.
3. For nameplates, see page 680.
4. For contact assembly part numbers, see page 685.
5. Five position circuit cannot be made to make five independent contact closures.
6. All assembled part numbers in catalog include standard finger-safe spring-up (HW-U...) contacts.
7. Standard color for knob and lever is black.
8. Optional colors available for lever type. Must order in components. See next page for part numbers.
9. Additional contact configurations available (up to 6 total contacts).
10. For Truth Tables see page 693.

Ⓢ Bezel Type

| Type | Code |
|---------|------|
| Plastic | 1 |
| Metal | 4 |

Part Number Structure



Note: Use only for interpreting part numbers. Do not use for developing part numbers.

Selector Switches 4- & 5-Position (Replacement Parts)



Contact Blocks

| Style | Contacts | 1NO | 1NC |
|-------|--------------------------------|------------------------|------------------------|
| | Finger-Safe Spring-Up Terminal | HW-U10-F | HW-U01-F |
| | | HW-U10R-F (early make) | HW-U01R-F (late break) |
| | Dummy Block | HW-DB | |

Anti-Rotation Ring

| Style | Part Number |
|-------|-------------|
| | HW9Z-RL |

Use with notched panel cutout to prevent unit rotation.

Operators

| Style | Position | Description | Handle | Plastic Bezel | Metal Bezel |
|-------|----------|-------------|--------|---------------|-------------|
| | 4 | Maintained | Knob | HW1S-4T | HW4S-4T |
| | | | Lever | HW1S-4 | HW4S-4 |
| | 5 | Maintained | Knob | HW1S-5T | HW4S-5T |
| | | | Lever | HW1S-5 | HW4S-5 |

1. Knob operator comes with black handle.
2. To order lever type, lever and inserts must be ordered separately, along with lever operator. See part numbers below.

Contact Block Mounting Adaptor

| Style | Part Number |
|-------|-------------|
| | HW-CB2C |

1. Used to mount contact blocks to operator (first pair only).
2. IDEC strongly recommends using the safety lever lock to prevent heavy vibration or maintenance personnel from inadvertently unlocking contacts.

Safety Lever Lock

| Style | Part Number |
|-------|-------------|
| | HW9Z-LS |

Levers & Inserts

| Style | Part Number |
|-------|-----------------------------|
| | Lever ASWHHL-⓪ |
| | Lever Color Insert TW-HC1-⓪ |

Standard lever color is black. Standard insert color is white.

① Handle/Insert Color Code



| Color | Code |
|--------|------|
| Black* | B |
| Blue | S |
| Green | G |
| Red | R |
| Yellow | Y |
| White† | W |

1. * Lever color inserts not available in black.
2. †Lever not available in white.

Key Switches 2-Position (Assembled)



2-Position Key Switches

| Contact | Mounting | Operator Position | | Maintained | Spring Return from Right |
|----------------------|----------|-------------------|---|---|---|
| | | L | R | L  R | L  R |
| <i>Operator Only</i> | | | | | |
| 1NO | 1 | 0 | X | HWⓈK-2AF10 | HWⓈK-21BF10 |
| 1NO-1NC | 1 | 0 | X | HWⓈK-2AF11 | HWⓈK-21BF11 |
| | 2 | X | 0 | | |
| 2NO | 1 | 0 | X | HWⓈK-2AF20 | HWⓈK-21BF20 |
| | 2 | 0 | X | | |
| 2NO-2NC | 1 | 0 | X | HWⓈK-2AF22 | HWⓈK-21BF22 |
| | 2 | X | 0 | | |
| | 3 | 0 | X | | |
| | 4 | X | 0 | | |



1. In place of Ⓢ enter 1 for plastic bezel or 4 for metal bezel.
2. Key is removable in all maintained positions. Other key removable options available.
3. Two keys are supplied with all switches.
4. All standard operators are keyed alike.
5. Other key removable options available. See table below
6. For nameplates, see page 680.
7. For contact assembly part numbers, see page 685.
8. Key is retained in "Spring Return" position.
9. All assembled part numbers in catalog include finger-safe spring-up (HW-U...) contacts.
10. Additional contact configurations available (up to 6 total contacts).
11. For Truth Tables see page 685.

Ⓢ Bezel Type

| Type | Code |
|---------|------|
| Plastic | 1 |
| Metal | 4 |

Key Removable Option Codes

| Code | Description |
|------|---|
| A | Key not retained in any position (removable in all positions) |
| B | Key retained in right position only (removable LEFT) |
| C | Key retained in left position only (removable RIGHT) |

Part Number Structure

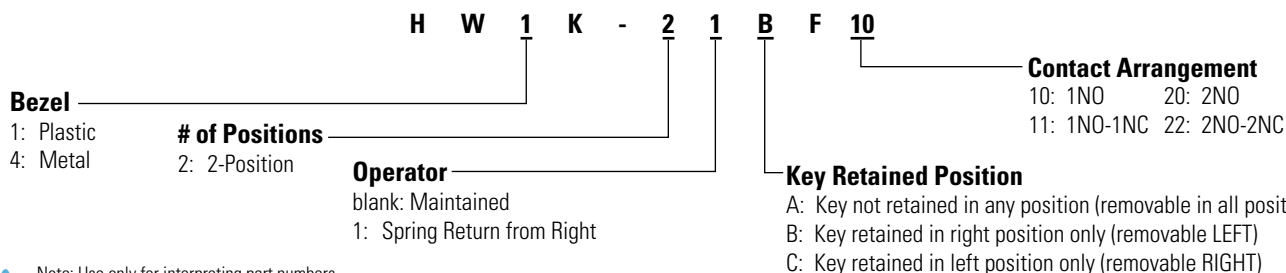



 Note: Use only for interpreting part numbers. Do not use for developing part numbers.

Key Switches 2-Position (Replacement Parts)



Contact Blocks

| Style | Contacts | 1NO | 1NC |
|---|--------------------|------------------------|------------------------|
|  | Finger-Safe | HW-U10-F | HW-U01-F |
| | Spring-Up Terminal | HW-U10R-F (early make) | HW-U01R-F (late break) |
|  | Dummy Block | HW-DB | |

Safety Lever Lock

| Style | Part Number |
|---|-------------|
|  | HW9Z-LS |

Anti-Rotation Ring

| Style | Part Number |
|---|-------------|
|  | HW9Z-RL |



Use with notched panel cutout to prevent unit rotation.

Contact Block Mounting Adaptor

| Style | Part Number |
|---|-------------|
|  | HW-CB2C |



- Used to mount contact blocks to operator (first pair only).
- IDEC strongly recommends using the safety lever lock to prevent heavy vibration or maintenance personnel from inadvertently unlocking contacts.

Operators

| Style | Description | Plastic Bezel | Metal Bezel |
|---|------------------------------------|---------------|-------------|
|  | Maintained | HW1K-2A | HW4K-2A |
| | Maintained, key removed left only | HW1K-2B | HW4K-2B |
| | Spring Return from Right | HW1K-21B | HW4K-21B |
| | Maintained, key removed right only | HW1K-2C | HW4K-2C |



- Operator includes two keys.
- All standard operators are keyed alike.

Key Switches 3-Position (Assembled)



3-Position Key Switches

| Contact | Mounting | Operator Position | | | Maintained | Spring Return from Right | Spring Return from Left | Spring Return Two Way |
|----------------------|----------|-------------------|---|---|---------------|--------------------------|-------------------------|-----------------------|
| | | L | C | R | | | | |
| <i>Operator Only</i> | | | | | HW⊙K-3A* | HW⊙K-31B | HW⊙K-32C | HW⊙K-33D |
| 1NO-1NC | 1 | 0 | X | X | HW⊙K-3AF11 | HW⊙K-31BF11 | HW⊙K-32CF11 | HW⊙K-33DF11 |
| | 2 | 0 | 0 | X | | | | |
| 2NO | 1 | X | 0 | 0 | HW⊙K-3AF20 | HW⊙K-31BF20 | HW⊙K-32CF20 | HW⊙K-33DF20 |
| | 2 | 0 | 0 | X | | | | |
| 2NC | 1 | 0 | X | X | HW⊙K-3AF02 | HW⊙K-31BF02 | HW⊙K-32CF02 | HW⊙K-33DF02 |
| | 2 | X | X | 0 | | | | |
| 2NO-1NC | 1 | X | 0 | 0 | HW⊙K-3JAF21N1 | - | - | - |
| | 2 | 0 | 0 | X | | | | |
| | 3 | 0 | X | 0 | | | | |
| 2NO-2NC | 1 | X | 0 | 0 | HW⊙K-3AF22 | HW⊙K-31BF22 | HW⊙K-32CF22 | HW⊙K-33DF22 |
| | 2 | 0 | 0 | X | | | | |
| | 3 | 0 | X | X | | | | |
| | 4 | X | X | 0 | | | | |
| 2NO-2NC | 1 | 0 | 0 | X | HW⊙K-3SAF22N9 | - | - | - |
| | 2 | X | 0 | 0 | | | | |
| | 3 | X | X | 0 | | | | |
| | 4 | 0 | 0 | X | | | | |
| 4NO | 1 | X | 0 | 0 | HW⊙K-3AF40 | HW⊙K-31BF40 | HW⊙K-32CF40 | HW⊙K-33DF40 |
| | 2 | 0 | 0 | X | | | | |
| | 3 | X | 0 | 0 | | | | |
| | 4 | 0 | 0 | X | | | | |
| 4NO | 1 | X | 0 | 0 | HW⊙K-3SAF40N2 | - | - | - |
| | 2 | 0 | X | X | | | | |
| | 3 | X | 0 | 0 | | | | |
| | 4 | 0 | 0 | X | | | | |
| 4NC | 1 | 0 | X | X | HW⊙K-3AF04 | HW⊙K-31BF04 | HW⊙K-32CF04 | HW⊙K-33DF04 |
| | 2 | X | X | 0 | | | | |
| | 3 | 0 | X | X | | | | |
| | 4 | X | X | 0 | | | | |

Ⓢ Bezel Type

| Type | Code |
|---------|------|
| Plastic | 1 |
| Metal | 4 |

- In place of ⊙ enter 1 for plastic bezel or 4 for metal bezel.
- Key is removable in all maintained positions. Other key removable options available.
- Two keys are supplied with all switches.
- All standard operators are keyed alike.
- Other key removable options available. See table to the right.
- * Operator is available with three different cams.
HW⊙K-3A: Maintained (standard cam)
HW⊙K-3SA: Maintained (Cam S)
HW⊙K-3JA: Maintained (Cam J)
- For nameplates, see page 680.

- For contact assembly part numbers, see page 685.
- All assembled part numbers in catalog include standard Finger-Safe spring-up (HW-U...) contacts.
- Additional contact configurations available (up to 6 total contacts).
- For Truth Tables see page 693.

Key Removable Option Codes

| Code | Description |
|------|---|
| A | Key not retained in any position (removable in all positions) |
| B | Key retained in right position only |
| C | Key retained in left position only |
| D | Key retained in left and right (3 position only) |
| E | Key retained in center only (3 position only) |
| G | Key retained right and center (3 position only) |
| H | Key retained left and center (3 position only) |

Part Number Structure



Note: Use only for interpreting part numbers. Do not use for developing part numbers.

Key Switches 3-Position (Replacement Parts)

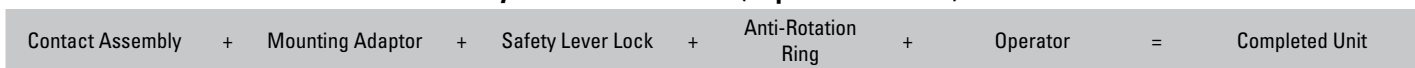

Contact Blocks

| Style | Contacts | 1NO | 1NC |
|-------|--------------------------------|------------------------|------------------------|
| | Finger-Safe Spring-Up Terminal | HW-U10-F | HW-U01-F |
| | | HW-U10R-F (early make) | HW-U01R-F (late break) |
| | Dummy Block | HW-DB | |

Safety Lever Lock

| Style | Part Number |
|-------|-------------|
| | HW9Z-LS |

Anti-Rotation Ring

| Style | Part Number |
|-------|-------------|
| | HW9Z-RL |

Use with notched panel cutout to prevent unit rotation.

Contact Block Mounting Adaptor

| Style | Part Number |
|-------|-------------|
| | HW-CB2C |

-
- Used to mount contact blocks to operator (first pair only).
 - IDEC strongly recommends using the safety lever lock to prevent heavy vibration or maintenance personnel from inadvertently unlocking contacts.

Operators

| Style | Description | Plastic Bezel | Metal Bezel |
|-------|---|---------------|-------------|
| | Maintained (standard cam) | HW1K-3A | HW4K-3A |
| | Maintained (S cam) | HW1K-3SA | HW4K-3SA |
| | Maintained (J cam) | HW1K-3JA | HW4K-3JA |
| | Spring Return from Right (standard cam) | HW1K-31B | HW4K-31B |
| | Spring Return from Left (standard cam) | HW1K-32C | HW4K-32C |
| | 2-Way Spring Return (standard cam) | HW1K-33D | HW4K-33D |

-
- Operator includes two keys.
 - All standard operators are keyed alike.
 - Other key removable options available. See table on previous page.
 - Key not removable from spring-returned position

Illuminated Selector Switches 2-Position (Assembled)



2-Position Illuminated Selector Switches

| Contact | Mounting | Style | | Part Number | | | |
|----------------------|------------------|-------------------|------------------|--------------|---|--|--|
| | | Operator Position | | Type | Maintained | Spring Return from Right | |
| | | L | R | | | | |
| <i>Operator Only</i> | | | | | HW ^⑤ F-2 ^② | HW ^⑤ F-21 ^② | |
| 1NO-1NC | 1 2 | 0 X | X 0 | Full Voltage | HW ^⑤ F-2F11QD- ^② - ^③ | HW ^⑤ F-21F11QD- ^② - ^③ | |
| | | | | Transformer | 120V | HW ^⑤ F-2F11H2D- ^② | HW ^⑤ F-21F11H2D- ^② |
| | | | | | 240V | HW ^⑤ F-2F11M4D- ^② | HW ^⑤ F-21F11M4D- ^② |
| 2NO | 1 2 | X 0 | 0 X | Full Voltage | HW ^⑤ F-2F20QD- ^② - ^③ | HW ^⑤ F-21F20QD- ^② - ^③ | |
| | | | | Transformer | 120V | HW ^⑤ F-2F20H2D- ^② | HW ^⑤ F-21F20H2D- ^② |
| | | | | | 240V | HW ^⑤ F-2F20M4D- ^② | HW ^⑤ F-21F20M4D- ^② |
| 2NO-2NC | 1 2 3 4 | 0 X 0 X | X 0 X 0 | Full Voltage | HW ^⑤ F-2F22QD- ^② - ^③ | HW ^⑤ F-21F22QD- ^② - ^③ | |
| | | | | Transformer | 120V | HW ^⑤ F-2F22H2D- ^② | HW ^⑤ F-21F22H2D- ^② |
| | | | | | 240V | HW ^⑤ F-2F22M4D- ^② | HW ^⑤ F-21F22M4D- ^② |
| | | | | 480V | HW ^⑤ F-2F22T8D- ^② | HW ^⑤ F-21F22T8D- ^② | |

- 1. In place of ^② specify Lens/LED color code.
- 2. In place of ^③ specify Full Voltage code.
- 3. In place of ^⑤ enter 1 for plastic bezel or 4 for metal bezel.
- 4. For nameplates, see page 680.
- 5. For contact assembly part numbers, see page 685.
- 6. Light is independent of switch position.
- 7. All assembled part numbers in catalog include standard Finger-Safe spring-up (HW-U...) contacts.
- 8. Yellow selector switch comes with white LED.**
- 9. Additional contact configurations available (up to 6 total contacts).
- 10. For Truth Tables see page 693.

② Lens/LED Color Code

| Color | Code |
|--------|------|
| Amber | A |
| Green | G |
| Red | R |
| Blue | S |
| White | W |
| Yellow | Y |

③ Full Voltage Code

| Full Voltage Models | |
|---------------------|------|
| Voltage | Code |
| 6VAC/DC | 6V |
| 12VAC/DC | 12V |
| 24VAC/DC | 24V |
| 120V AC | 120V |
| 240V AC | 240V |

⑤ Bezel Code

| Type | Code |
|---------|------|
| Plastic | 1 |
| Metal | 4 |

Part Number Structure

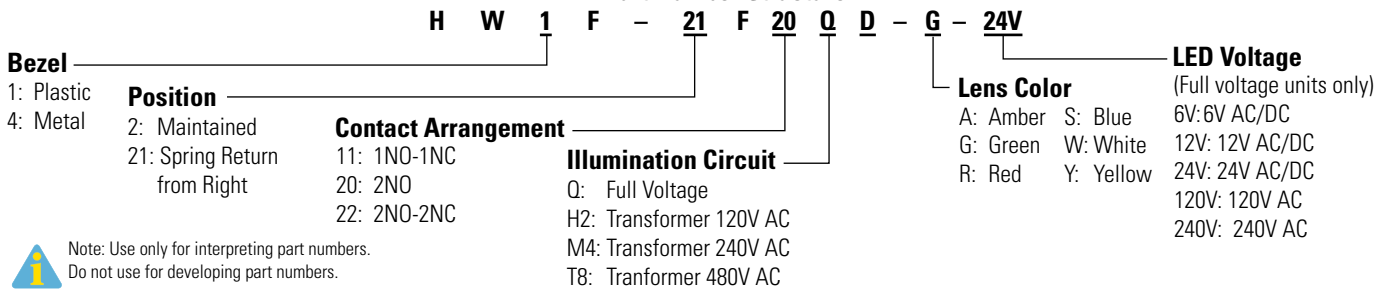

Illuminated Selector Switches 2-Position (Replacement Parts)

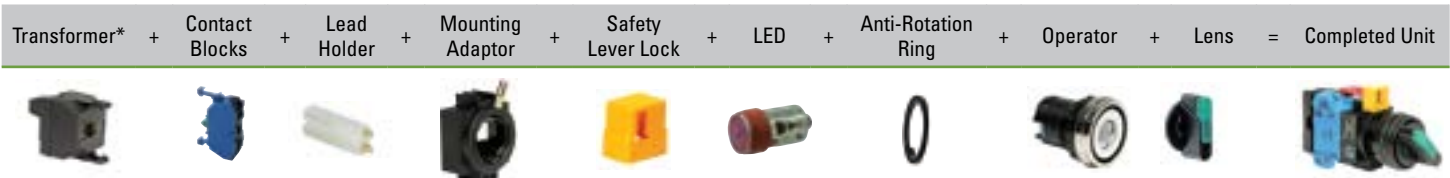

*Transformer not needed with full voltage models.

Lamp Circuit Components

| Style | Description | Terminals | Part Number |
|-------|---|-------------|----------------------------------|
| | For use with HW-CBL on all illuminated pushbutton units. One required for each deck (pair) of contacts. | | HW-LH3 |
| | For use with odd number of contacts. | Finger-Safe | HW-DA1FBN |
| | For use with even number of contacts. | Finger-Safe | TW-DA1FB |
| | 120VAC 240VAC 480VAC | Finger-Safe | TW-F126B TW-F246B TW-F486B |
| | 110VDC | | HW-L16D |

- DC-DC convertor features spring-up terminals.
- DC-DC convertor applicable voltage range 90-140V DC.

Operators

| Style | Description | Plastic Bezel | Metal Bezel |
|-------|--------------------------|---------------|-------------|
| | Maintained | HW1F-2 | HW4F-2 |
| | Spring return from right | HW1F-21 | HW4F-21 |

Illuminated knobs must be ordered separately.

Contact Blocks

| Style | Contacts | 1NO | 1NC |
|-------|--------------------------------|------------------------------------|------------------------------------|
| | Finger-Safe Spring-Up Terminal | HW-U10-F HW-U10R-F (early make) | HW-U01-F HW-U01R-F (late break) |

Contact Block Mounting Adaptor

| Style | Part Number |
|-------|-------------|
| | HW-CBL |

- Used to mount contact blocks to operator (first pair only).
- IEC strongly recommends using the safety lever lock to prevent heavy vibration or maintenance personnel from inadvertently unlocking contacts.

Safety Lever Lock

| Style | Part Number |
|-------|-------------|
| | HW9Z-LS |

Illuminated Knob

| Appearance | Part Number |
|------------|-------------|
| | HW9Z-FDY-⊙ |

In place of ⊙, specify the Color Code.

⊙ Lens/LED Color Code

| Color | Code | Color | Code |
|-------|------|--------|------|
| Amber | A | Blue | S |
| Green | G | White | W |
| Red | R | Yellow | Y |

Anti-Rotation Ring

| Style | Part Number |
|-------|-------------|
| | HW9Z-RL |

Use with notched panel cutout to prevent unit rotation.

Lamps

| Style | Voltage | Part Number |
|-------|-----------|-------------|
| | 6V AC/DC | LSTD-6⊙ |
| | 12V AC/DC | LSTD-1⊙ |
| | 24V AC/DC | LSTD-2⊙ |
| | 120V AC | LSTD-H2⊙ |
| | 240V AC | LSTD-M4⊙ |

- In place of ⊙, specify the LED Color Code.
- The LED contains a current-limiting resistor and reverse polarity protection diodes.
- Use white LED for yellow lens. Yellow LED not available.

Illuminated Selector Switches 3-Position (Assembled)



3-Position Illuminated Selector Switches

| Contact | Mounting | Style | | | Part Number | | | | |
|----------------------|------------------|-------------------|---------------------|---------------------|-----------------|---------------------|--------------------------|-------------------------|-----------------------|
| | | Operator Position | | | Type | Maintained | Spring Return from Right | Spring Return from Left | Spring Return Two-Way |
| | | L | C | R | | L C R | L C R | L C R | L C R |
| <i>Operator Only</i> | | | | | | HW⊙F-3② | HW⊙F-31② | HW⊙F-32② | HW⊙F-33② |
| 1NO-1NC | 1 2 | 0 | X | X | Full Voltage | HW⊙F-3F11QD-②-③ | HW⊙F-31F11QD-②-③ | HW⊙F-32F11QD-②-③ | HW⊙F-33F11QD-②-③ |
| | | 0 | 0 | X | Transformer | 120V HW⊙F-3F11H2D-② | HW⊙F-31F11H2D-② | HW⊙F-32F11H2D-② | HW⊙F-33F11H2D-② |
| | | 0 | 0 | 240V HW⊙F-3F11M4D-② | | HW⊙F-31F11M4D-② | HW⊙F-32F11M4D-② | HW⊙F-33F11M4D-② | |
| 0 | 0 | X | 480V HW⊙F-3F11T8D-② | HW⊙F-31F11T8D-② | HW⊙F-32F11T8D-② | HW⊙F-33F11T8D-② | | | |
| 2NO | 1 2 | X | 0 | 0 | Full Voltage | HW⊙F-3F20QD-②-③ | HW⊙F-31F20QD-②-③ | HW⊙F-32F20QD-②-③ | HW⊙F-33F20QD-②-③ |
| | | 0 | 0 | X | Transformer | 120V HW⊙F-3F20H2D-② | HW⊙F-31F20H2D-② | HW⊙F-32F20H2D-② | HW⊙F-33F20H2D-② |
| | | 0 | 0 | 240V HW⊙F-3F20M4D-② | | HW⊙F-31F20M4D-② | HW⊙F-32F20M4D-② | HW⊙F-33F20M4D-② | |
| 0 | 0 | X | 480V HW⊙F-3F20T8D-② | HW⊙F-31F20T8D-② | HW⊙F-32F20T8D-② | HW⊙F-33F20T8D-② | | | |
| 2NC | 1 2 | 0 | X | X | Full Voltage | HW⊙F-3F02QD-②-③ | HW⊙F-31F02QD-②-③ | HW⊙F-32F02QD-②-③ | HW⊙F-33F02QD-②-③ |
| | | X | X | 0 | Transformer | 120V HW⊙F-3F02H2D-② | HW⊙F-31F02H2D-② | HW⊙F-32F02H2D-② | HW⊙F-33F02H2D-② |
| | | X | X | 240V HW⊙F-3F02M4D-② | | HW⊙F-31F02M4D-② | HW⊙F-32F02M4D-② | HW⊙F-33F02M4D-② | |
| 0 | 0 | X | 480V HW⊙F-3F02T8D-② | HW⊙F-31F02T8D-② | HW⊙F-32F02T8D-② | HW⊙F-33F02T8D-② | | | |
| 2NO-2NC | 1 2 3 4 | X | 0 | 0 | Full Voltage | HW⊙F-3F22QD-②-③ | HW⊙F-31F22QD-②-③ | HW⊙F-32F22QD-②-③ | HW⊙F-33F22QD-②-③ |
| | | 0 | 0 | X | Transformer | 120V HW⊙F-3F22H2D-② | HW⊙F-31F22H2D-② | HW⊙F-32F22H2D-② | HW⊙F-33F22H2D-② |
| | | 0 | X | 240V HW⊙F-3F22M4D-② | | HW⊙F-31F22M4D-② | HW⊙F-32F22M4D-② | HW⊙F-33F22M4D-② | |
| X | X | 0 | 480V HW⊙F-3F22T8D-② | HW⊙F-31F22T8D-② | HW⊙F-32F22T8D-② | HW⊙F-33F22T8D-② | | | |
| 4NO | 1 2 3 4 | X | 0 | 0 | Full Voltage | HW⊙F-3F40QD-②-③ | HW⊙F-31F40QD-②-③ | HW⊙F-32F40QD-②-③ | HW⊙F-33F40QD-②-③ |
| | | 0 | 0 | X | Transformer | 120V HW⊙F-3F40H2D-② | HW⊙F-31F40H2D-② | HW⊙F-32F40H2D-② | HW⊙F-33F40H2D-② |
| | | X | 0 | 240V HW⊙F-3F40M4D-② | | HW⊙F-31F40M4D-② | HW⊙F-32F40M4D-② | HW⊙F-33F40M4D-② | |
| 0 | 0 | X | 480V HW⊙F-3F40T8D-② | HW⊙F-31F40T8D-② | HW⊙F-32F40T8D-② | HW⊙F-33F40T8D-② | | | |
| 4NC | 1 2 3 4 | 0 | X | X | Full Voltage | HW⊙F-3F04QD-②-③ | HW⊙F-31F04QD-②-③ | HW⊙F-32F04QD-②-③ | HW⊙F-33F04QD-②-③ |
| | | X | X | 0 | Transformer | 120V HW⊙F-3F04H2D-② | HW⊙F-31F04H2D-② | HW⊙F-32F04H2D-② | HW⊙F-33F04H2D-② |
| | | 0 | X | 240V HW⊙F-3F04M4D-② | | HW⊙F-31F04M4D-② | HW⊙F-32F04M4D-② | HW⊙F-33F04M4D-② | |
| X | X | 0 | 480V HW⊙F-3F04T8D-② | HW⊙F-31F04T8D-② | HW⊙F-32F04T8D-② | HW⊙F-33F04T8D-② | | | |



- In place of ⊙ specify Lens/LED color code.
- In place of ⊙ specify Full Voltage code.
- In place of ⊙ enter 1 for plastic bezel or 4 for metal bezel.
- For nameplates, see page 680.
- For contact assembly part numbers, see page 685.
- Light is independent of switch position.
- All assembled part numbers in catalog include standard Finger-Safe spring-up (HW-U..) contacts.
- Yellow selector switch comes with white LED.**
- Additional contact configurations available (up to 6 total contacts).
- For Truth Tables see page 693.

② Lens/LED Color

| Color | Code |
|--------|------|
| Amber | A |
| Green | G |
| Red | R |
| Blue | S |
| White | W |
| Yellow | Y |

③ Full Voltage Code

| Full Voltage Models | |
|---------------------|------|
| Voltage | Code |
| 6VAC/DC | 6V |
| 12VAC/DC | 12V |
| 24VAC/DC | 24V |
| 120V AC | 120V |
| 240V AC | 240V |

⑤ Bezel Code

| Type | Code |
|---------|------|
| Plastic | 1 |
| Metal | 4 |

Part Number Structure

H W 1 F - 31 F 20 Q D - G - 24V

Bezel
1: Plastic
4: Metal

Position
3: Maintained
31: Spring Return from Right
32: Spring Return from Left
33: Spring Return 2-Way

Contact Arrangement
11: 1NO-1NC 22: 2NO-2NC
20: 2NO 40: 4NO
02: 2NC 04: 4NC

Illumination Circuit
Q: Full Voltage
H2: Transformer 120V AC
M4: Transformer 240V AC
T8: Transformer 480V AC

Lens Color
A: Amber S: Blue
G: Green W: White
R: Red Y: Yellow

Full Voltage Code
6V: 6V AC/DC
12V: 12V AC/DC
24V: 24V AC/DC
120V: 120V AC
240V: 240V AC

 Note: Use only for interpreting part numbers. Do not use for developing part numbers.

Illuminated Selector Switches 3-Position (Replacement Parts)

Transformer* + Contact Blocks + Lead Holder + Mounting Adaptor + Safety Lever Lock + LED + Anti-Rotation Ring + Operator + Lens = Completed Unit



 *Transformer not needed with full voltage models.

Lamp Circuit Components

| Style | Description | Terminals | Part Number |
|---|---|-------------|----------------------------------|
|  | For use with HW-CBL on all illuminated pushbutton units. One required for each deck (pair) of contacts. | | HW-LH3 |
|  | For use with odd number of contacts. | Finger-Safe | HW-DA1FBN |
|  | For use with even number of contacts. | Finger-Safe | TW-DA1FB |
|  | 120VAC 240VAC 480VAC | Finger-Safe | TW-F126B TW-F246B TW-F486B |
|  | 110VDC | | HW-L16D |

 1. DC-DC convertor features spring-up terminals.
2. DC-DC convertor applicable voltage range 90-140V DC.

Operators

| Style | Description | Plastic Bezel | Metal Bezel |
|---|--------------------------|---------------|-------------|
|  | Maintained | HW1F-3 | HW4F-3 |
| | Spring return from right | HW1F-31 | HW4F-31 |
| | Spring return from left | HW1F-32 | HW4F-32 |
| | 2-Way spring return | HW1F-33 | HW4F-33 |

 Illuminated knobs must be ordered separately.

Contact Blocks

| Style | Contacts | 1NO | 1NC |
|---|--------------------------------|------------------------------------|------------------------------------|
|  | Finger-Safe Spring-Up Terminal | HW-U10-F HW-U10R-F (early make) | HW-U01-F HW-U01R-F (late break) |

Contact Block Mounting Adaptor

| Style | Part Number |
|---|-------------|
|  | HW-CBL |

 1. Used to mount contact blocks to operator (first pair only).
2. IDEC strongly recommends using the safety lever lock to prevent heavy vibration or maintenance personnel from inadvertently unlocking contacts.

Safety Lever Lock

| Style | Part Number |
|---|-------------|
|  | HW9Z-LS |

Illuminated Knob

| Appearance | Part Number |
|---|-------------|
|  | HW9Z-FDY-⊙ |

 In place of ⊙, specify the Color Code.

⊙ Lens/LED Color Code

| Color | Code | Color | Code |
|-------|------|--------|------|
| Amber | A | Blue | S |
| Green | G | White | W |
| Red | R | Yellow | Y |

Anti-Rotation Ring

| Style | Part Number |
|---|-------------|
|  | HW9Z-RL |

 Use with notched panel cutout to prevent unit rotation.

Lamps

| Style | Voltage | Part Number |
|---|-----------|-------------|
|  | 6V AC/DC | LSTD-6⊙ |
| | 12V AC/DC | LSTD-1⊙ |
| | 24V AC/DC | LSTD-2⊙ |
| | 120V AC | LSTD-H2⊙ |
| | 240V AC | LSTD-M4⊙ |

 1. In place of ⊙, specify the LED Color Code.
2. The LED contains a current-limiting resistor and reverse polarity protection diodes.
3. Use white LED for yellow lens. Yellow LED not available.

Mono Lever Switches 2-Position (Assembled)



2-Position Mono Lever Switches

| Style | Part Number | Description |
|------------------------------|------------------------------|------------------------------|
| HW1M Standard Lever | HW1M-F1010-20 | Maintained up and down |
| | HW1M-F2020-20 | Spring return up and down |
| | HW1M-F1010-40 | Maintained up and down |
| | HW1M-F2020-40 | Spring return up and down |
| | HW1M-F0101-20 | Maintained right and left |
| | HW1M-F0202-20 | Spring return right and left |
| | HW1M-F0101-40 | Maintained right and left |
| HW1M-L Interlocking Lever | HW1M-F0202-40 | Spring return right and left |
| | HW1M-LF1010-20 | Maintained up and down |
| | HW1M-LF2020-20 | Spring return up and down |
| | HW1M-LF1010-40 | Maintained up and down |
| | HW1M-LF2020-40 | Spring return up and down |
| | HW1M-LF0101-20 | Maintained right and left |
| | HW1M-LF0202-20 | Spring return right and left |
| HW1M-LF0101-40 | Maintained right and left | |
| HW1M-LF0202-40 | Spring return right and left | |



All Assembled units with Finger-Safe spring-up (HW-U...) contacts

Circuit Diagrams

2 Position Left/Right

| Circuit Number | Contact Mounting | | Position | | |
|----------------|------------------|----------|----------|--------|-------|
| | No. | | Left | Center | Right |
| 20 | 1 | HW-U10-F | X | 0 | 0 |
| | 2 | HW-U10-F | 0 | 0 | X |
| 40 | 1 | HW-U10-F | X | 0 | 0 |
| | 2 | HW-U10-F | 0 | 0 | X |
| | 3 | HW-U10-F | X | 0 | 0 |
| | 4 | HW-U10-F | 0 | 0 | X |

2 Position Up/Down

| Circuit Number | Contact Mounting | | Position | | |
|----------------|------------------|----------|----------|--------|----|
| | No. | | Down | Center | Up |
| 20 | 1 | HW-U10-F | X | 0 | 0 |
| | 2 | HW-U10-F | 0 | 0 | X |
| 40 | 1 | HW-U10-F | X | 0 | 0 |
| | 2 | HW-U10-F | 0 | 0 | X |
| | 3 | HW-U10-F | X | 0 | 0 |
| | 4 | HW-U10-F | 0 | 0 | X |

Part Number Structure



Note: Use only for interpreting part numbers. Do not use for developing part numbers.

Mono Lever Switches 2-Position (Sub-assembled) Part Numbers



Contact Blocks

| Style | Contacts | 1NO | 1NC |
|-------|--------------------------------|------------------------|------------------------|
| | Finger-Safe Spring-Up Terminal | HW-U10-F | HW-U01-F |
| | | HW-U10R-F (early make) | HW-U01R-F (late break) |
| | Dummy Block | HW-DB | |

Anti-Rotation Ring

| Style | Part Number |
|-------|-------------|
| | HW9Z-RL |

Use with notched panel cutout to prevent unit rotation.

Operators

| Style | Description | Part Number | |
|-------|--------------|--------------------------|------------|
| | Standard | Maintained Up/Down | HW1M-1010 |
| | | Spring return Up/Down | HW1M-2020 |
| | | Maintained Left/Right | HW1M-0101 |
| | | Spring return Left/Right | HW1M-0202 |
| | Interlocking | Maintained Up/Down | HW1M-L1010 |
| | | Spring return Up/Down | HW1M-L2020 |
| | | Maintained Left/Right | HW1M-L0101 |
| | | Spring return Left/Right | HW1M-L0202 |

Contact Block Mounting Adaptor

| Style | Part Number |
|-------|-------------|
| | HW-CB2C |

1. Used to mount contact blocks to operator (first pair only).
2. IDEC strongly recommends using the safety lever lock (included) to prevent heavy vibration or maintenance personnel from inadvertently unlocking contacts.

Safety Lever Lock

| Style | Part Number |
|-------|-------------|
| | HW9Z-LS |

Replacement Parts

| Item | Part Number |
|-----------|--|
| Black Cap | HW9Z-CPM |
| Boot | |
| | HW9Z-BLM (fits standard operator only) |

Mono Lever Switches 3- & 4-Position (Assembled)



3-Position

| Style | Part Number | Description |
|------------------------------|------------------|---|
| HW1M Standard Lever | HW1M-F0121-12N3 | Maintained right and left, spring return down |
| | HW1M-F0222-12N3 | Spring return right, down, left |
| HW1M-L Interlocking Lever | HW1M-LF0121-12N3 | Maintained right and left, spring return down |
| | HW1M-LF0222-12N3 | Spring return right, down, left |

Circuit Diagram

| Circuit Number | Contact Mounting | | Position | | | | |
|----------------|------------------|----------|----------|------|--------|----|-------|
| | No. | | Down | Left | Center | Up | Right |
| 12N3 | 1 | HW-U01-F | 0 | 0 | 0 | 0 | X |
| | 2 | HW-U01-F | X | 0 | 0 | 0 | 0 |
| | 3 | HW-U10-F | 0 | X | 0 | 0 | 0 |

4-Position

| Style | Part Number | Description |
|------------------------------|------------------|---|
| HW1M Standard Lever | HW1M-F1111-22N9 | Maintained all positions |
| | HW1M-F1212-22N9 | Maintained up and down, spring left and right |
| | HW1M-2121-22N9 | Spring up and down, maintained left and right |
| | HW1M-2222-22N9 | Spring return all positions |
| HW1M-L Interlocking Lever | HW1M-LF1111-22N9 | Maintained all positions |
| | HW1M-LF1212-22N9 | Maintained up and down, spring left and right |
| | HW1M-LF2121-22N9 | Spring up and down, maintained left and right |
| | HW1M-LF2222-22N9 | Spring return all positions |

Circuit Diagram

| Circuit Number | Contact Mounting | | Position | | | | |
|----------------|------------------|----------|----------|------|--------|----|-------|
| | No. | | Down | Left | Center | Up | Right |
| 22N9 | 1 | HW-U01-F | 0 | 0 | 0 | 0 | X |
| | 2 | HW-U01-F | X | 0 | 0 | 0 | 0 |
| | 3 | HW-U10-F | 0 | X | 0 | 0 | 0 |
| | 4 | HW-U10-F | 0 | 0 | 0 | X | 0 |

 All assembled part numbers in catalog include Finger-Safe spring-up (HW-U...) contacts.

Part Number Structure

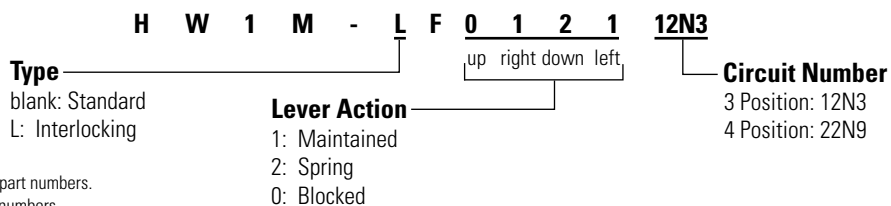

Note: Use only for interpreting part numbers. Do not use for developing part numbers.

Mono Lever Switches 3 & 4-Position (Sub-assembled) Part Numbers

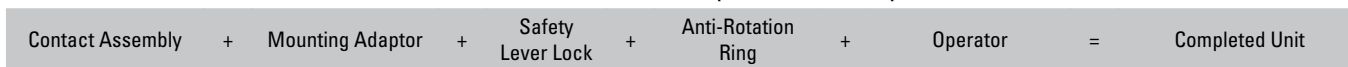

Contact Blocks

| Style | Contacts | 1NO | 1NC |
|-------|--------------------------------|------------------------|------------------------|
| | Finger-Safe Spring-Up Terminal | HW-U10-F | HW-U01-F |
| | | HW-U10R-F (early make) | HW-U01R-F (late break) |
| | Dummy Block | HW-DB | |

Contact Block Mounting Adaptor

| Style | Part Number |
|-------|-------------|
| | HW-CB2C |

1. Used to mount contact blocks to operator (first pair only).
 2. IDEC strongly recommends using the safety lever lock (included) to prevent heavy vibration or maintenance personnel from inadvertently unlocking contacts.

Safety Lever Lock

| Style | Part Number |
|-------|-------------|
| | HW9Z-LS |

Anti-Rotation Ring

| Style | Part Number |
|-------|-------------|
| | HW9Z-RL |

Use with notched panel cutout to prevent unit rotation.

Operators

| Style | Description | Part Number |
|-------|---------------------------|-------------|
| | Standard | |
| | Combination, 3 position | HW1M-0121 |
| | Spring return, 3 position | HW1M-0222 |
| | Maintained, 4 position | HW1M-1111 |
| | Combination, 4 position | HW1M-1212 |
| | Combination, 4 position | HW1M-2121 |
| | Interlocking | |
| | Combination, 3 position | HW1M-L0121 |
| | Spring return, 3 position | HW1M-L0222 |
| | Maintained, 4 position | HW1M-L1111 |
| | Combination, 4 position | HW1M-L1212 |
| | Combination, 4 position | HW1M-L2121 |
| | Spring return, 4 position | HW1M-L2222 |

Replacement Parts

| Item | Part Number |
|-----------|--|
| Black Cap | |
| | HW9Z-CPM |
| Boot | |
| | HW9Z-BLM (fits standard operator only) |

Pushbutton Selectors (Assembled)



2-Position Pushbutton Selectors

| Cam | Contacts | Mounting | Operator Position | | | | Part Number | |
|----------|----------------------|----------|-------------------|------|--------|------|--------------|----------------|
| | | | Left | | Right | | | |
| | | | Normal | Push | Normal | Push | | |
| A | <i>Operator Only</i> | | | | | | HW1R-2A-① | |
| | 1NO-1NC | 1 | HW-U10-F | 0 | X | 0 | X | HW1R-2AF11-① |
| | | 2 | HW-U01-F | X | 0 | 0 | 0 | |
| | 2NO | 1 | HW-U10-F | 0 | X | 0 | X | HW1R-2AF20-① |
| 2 | | HW-U10-F | 0 | X | X | X | | |
| 2NO-2NC | 1 | HW-U10-F | 0 | X | 0 | X | HW1R-2AF22-① | |
| | 2 | HW-U01-F | X | 0 | 0 | 0 | | |
| | 3 | HW-U10-F | 0 | X | 0 | X | | |
| | 4 | HW-U01-F | X | 0 | 0 | 0 | | |
| D | <i>Operator Only</i> | | | | | | HW1R-2D-① | |
| | 2NO | 1 | HW-U10-F | 0 | X | 0 | 0 | HW1R-2DF20-① |
| | | 2 | HW-U10-F | 0 | 0 | 0 | X | |
| | 2NO-2NC | 1 | HW-U10-F | 0 | X | 0 | 0 | HW1R-2DF22N1-① |
| 2 | | HW-U10-F | 0 | 0 | 0 | X | | |
| 3 | | HW-U01-F | X | 0 | X | X | | |
| 4 | | HW-U01-F | X | X | X | 0 | | |
| E | <i>Operator Only</i> | | | | | | HW1R-2E-① | |
| | 2NO-2NC | 1 | HW-U10-F | 0 | X | 0 | 0 | HW1R-2EF22N1-① |
| | | 2 | HW-U10-F | 0 | 0 | 0 | X | |
| | | 3 | HW-U01-F | 0 | 0 | X | X | |
| 4 | | HW-U01-F | X | X | 0 | 0 | | |
| F | <i>Operator Only</i> | | | | | | HW1R-2F-① | |
| | 2NO-2NC | 1 | HW-U10-F | 0 | 0 | 0 | X | HW1R-2FF22N1-① |
| | | 2 | HW-U10-F | 0 | X | 0 | 0 | |
| | | 3 | HW-U01-F | 0 | 0 | X | 0 | |
| 4 | | HW-U01-F | X | 0 | 0 | 0 | | |
| N | <i>Operator Only</i> | | | | | | HW1R-2N-① | |
| | 2NO-2NC | 1 | HW-U01-F | 0 | 0 | X | 0 | HW1R-2NF22N2-① |
| | | 2 | HW-U10-F | 0 | X | 0 | X | |
| | | 3 | HW-U01-F | 0 | 0 | X | 0 | |
| 4 | | HW-U10-F | 0 | X | 0 | X | | |
| T | <i>Operator Only</i> | | | | | | HW1R-2T-① | |
| | 2NO-2NC | 1 | HW-U10-F | 0 | X | X | | HW1R-2TF22N1-① |
| | | 2 | HW-U10-F | 0 | X | X | Blocked | |
| | | 3 | HW-U01-F | X | 0 | 0 | | |
| 4 | | HW-U01-F | X | 0 | 0 | | | |

① Button Color Code

| Color | Code | Color | Code |
|-------|------|--------|------|
| Black | B | White | W |
| Green | G | Yellow | Y |
| Red | R | | |
| Blue | S | | |

1. All assembled part numbers in catalog include Finger-Safe spring-up (HW-U...) contacts.
2. Operator only models come with operator and button.

Part Number Structure

H W 1 R - 2 D F 22N1 - R

Operator

- A: Cam A
- D: Cam D
- E: Cam E
- F: Cam F
- N: Cam N
- T: Cam T

Contact Arrangement Code

- 11: 1NO-1NC
- 20: 2NO
- (For additional contact codes see previous page)

Button Colors

- B: Black
- G: Green
- R: Red
- S: Blue
- W: White
- Y: Yellow



Note: Use only for interpreting part numbers. Do not use for developing part numbers.

Pushbutton Selectors (Sub-assembled)



Contact Blocks

| Style | Contacts | 1NO | 1NC |
|-------|--------------------------------|------------------------|------------------------|
| | Finger-Safe Spring-Up Terminal | HW-U10-F | HW-U01-F |
| | | HW-U10R-F (early make) | HW-U01R-F (late break) |
| | Dummy Block | HW-DB | |

Safety Lever Lock

| Style | Part Number |
|-------|-------------|
| | HW9Z-LS |

Buttons

| Style | Part Number |
|-------------|-------------|
| Round Flush | HW1A-B1-Ⓢ |
| | |



In place of Ⓢ, specify the Button Color Code from table below.

Ⓢ Button Color Code

| Color | Code | Color | Code |
|-------|------|--------|------|
| Black | B | White | W |
| Green | G | Yellow | Y |
| Red | R | | |
| Blue | S | | |

Contact Block Mounting Adaptor

(safety lever lock included)

| Style | Part Number |
|-------|-------------|
| | HW-CB2C |



- Used to mount contact blocks to operator (first pair only).
- IEDEC strongly recommends using the safety lever lock (included) to prevent heavy vibration or maintenance personnel from inadvertently unlocking contacts.

Anti-Rotation Ring

| Style | Part Number |
|-------|-------------|
| | HW9Z-RL |



Use with notched panel cutout to prevent unit rotation.

Operators

| Style | Description | Part Number |
|-------|-------------|-------------|
| | Cam A | HW1R-2A |
| | Cam D | HW1R-2D |
| | Cam E | HW1R-2E |
| | Cam F | HW1R-2F |
| | Cam N | HW1R-2N |
| | Cam T | HW1R-2T |

Dual Pushbutton Switches

Key features:

- Two pushbuttons and a pilot light are integrated into one space-saving ø22 mm control unit.
- Momentary and interlock types are available for pushbuttons. Interlock type prevents both buttons from being pressed at the same time.
- Pilot lights are available in full voltage and transformer with LED.
- IP40 protection, IP65 when using silicon boot.



Applications:

- Ideal for use as power switches and start/stop switches (available with I/ON and O/OFF markings on the buttons and a pilot light in the center).
- Interlock type prevents two pushbuttons from being pressed at the same time.



Dual Pushbutton Switches (Assembled) Part Numbers

Without Center Pilot Light

| Operation Type | Button Style | Image | Contact Arrangement | | Part Number | Ⓔ Button Color Code | Ⓕ Legend Code | | |
|----------------|----------------------------------|-------|---------------------|---------------|------------------|--------------------------------------|------------------------------------|--------------------------------------|------------------------------------|
| | | | Top Button | Bottom Button | | | | | |
| Momentary | Flush (top) Flush (bottom) | | 1NO | 1NC | HW7D-B11F1001-ⒺⒻ | GR: Green (top) Red (bottom) | Blank: Without legend | | |
| | | | 1NO | 1NO | HW7D-B11F1010-ⒺⒻ | | | | |
| | | | 1NO-1NC | 1NO-1NC | HW7D-B11F1111-ⒺⒻ | | | | |
| | | | 2NO | 2NC | HW7D-B11F2002-ⒺⒻ | | | | |
| | | | 2NO | 2NO | HW7D-B11F2020-ⒺⒻ | | | | |
| Momentary | Flush (top) Extended (bottom) | | 1NO | 1NC | HW7D-B12F1001-ⒺⒻ | | | GR: Green (top) Red (bottom) | Blank: Without legend |
| | | | 1NO | 1NO | HW7D-B12F1010-ⒺⒻ | | | | |
| | | | 1NO-1NC | 1NO-1NC | HW7D-B12F1111-ⒺⒻ | | | | |
| | | | 2NO | 2NC | HW7D-B12F2002-ⒺⒻ | | | | |
| | | | 2NO | 2NO | HW7D-B12F2020-ⒺⒻ | | | | |
| Interlock* | Flush (top) Flush (bottom) | | 1NO | 1NC | HW7D-B21F1001-ⒺⒻ | WB: White (top) Black (bottom) | 1: I/ON (top) O/OFF (bottom) | | |
| | | | 1NO | 1NO | HW7D-B21F1010-ⒺⒻ | | | | |
| | | | 1NO-1NC | 1NO-1NC | HW7D-B21F1111-ⒺⒻ | | | | |
| | | | 2NO | 2NC | HW7D-B21F2002-ⒺⒻ | | | | |
| | | | 2NO | 2NO | HW7D-B21F2020-ⒺⒻ | | | | |
| | Flush (top) Extended (bottom) | | 1NO | 1NC | HW7D-B22F1001-ⒺⒻ | | | WB: White (top) Black (bottom) | 1: I/ON (top) O/OFF (bottom) |
| | | | 1NO | 1NO | HW7D-B22F1010-ⒺⒻ | | | | |
| | | | 1NO-1NC | 1NO-1NC | HW7D-B22F1111-ⒺⒻ | | | | |
| | | | 2NO | 2NC | HW7D-B22F2002-ⒺⒻ | | | | |
| | | | 2NO | 2NO | HW7D-B22F2020-ⒺⒻ | | | | |

1. *Interlock type prevents both top and bottom buttons from being pressed simultaneously.
 2. Clear silicon rubber cover part number HW9Z-D7D.
 3. Additional contact configurations available (up to 6 total contacts).

With Center Pilot Light

| Operation Type | Button Style | | Top Button | Bottom Button | Part Number |
|----------------|----------------------------------|---|------------|---------------|--------------------|
| Momentary | Flush (Top) Flush (Bottom) | Flush (top) Flush (bottom) | 1NO | 1NC | HW7D-L11F1001②③-④⑤ |
| | | | 1NO | 1NO | HW7D-L11F1010②③-④⑤ |
| | | | 1NO-1NC | 1NO-1NC | HW7D-L11F1111②③-④⑤ |
| | | | 2NO | 2NC | HW7D-L11F2002②③-④⑤ |
| | | | 2NO | 2NO | HW7D-L11F2020②③-④⑤ |
| | Flush (Top) Extended (Bottom) |  | 1NO | 1NC | HW7D-L12F1001②③-④⑤ |
| | | | 1NO | 1NO | HW7D-L12F1010②③-④⑤ |
| | | | 1NO-1NC | 1NO-1NC | HW7D-L12F1111②③-④⑤ |
| | | | 2NO | 2NC | HW7D-L12F2002②③-④⑤ |
| | | | 2NO | 2NO | HW7D-L12F2020②③-④⑤ |
| Interlock* | Flush (Top) Flush (Bottom) | Flush (top) Extended (bottom) | 1NO | 1NC | HW7D-L21F1001②③-④⑤ |
| | | | 1NO | 1NO | HW7D-L21F1010②③-④⑤ |
| | | | 1NO-1NC | 1NO-1NC | HW7D-L21F1111②③-④⑤ |
| | | | 2NO | 2NC | HW7D-L21F2002②③-④⑤ |
| | | | 2NO | 2NO | HW7D-L21F2020②③-④⑤ |
| | Flush (Top) Extended (Bottom) |  | 1NO | 1NC | HW7D-L22F1001②③-④⑤ |
| | | | 1NO | 1NO | HW7D-L22F1010②③-④⑤ |
| | | | 1NO-1NC | 1NO-1NC | HW7D-L22F1111②③-④⑤ |
| | | | 2NO | 2NC | HW7D-L22F2002②③-④⑤ |
| | | | 2NO | 2NO | HW7D-L22F2020②③-④⑤ |

- 1. *Interlock type prevents both top and bottom buttons from being pressed simultaneously.
- 2. Clear silicon rubber cover part number HW9Z-D7D.
- 3. All assembled part numbers in catalog include Finger-Safe spring-up (HW-U...) contacts.

② Pilot Light Illumination & Voltage Code

| Full Voltage | |
|---|------|
| Voltage | Code |
| 6V AC/DC, LED | Q2 |
| 12V AC/DC, LED | Q3 |
| 24V AC/DC, LED | Q4 |
| 120V AC, LED | Q8 |
| Step-Down Transformer (6V Secondary LED Voltage) | |
| Voltage | Code |
| 120V AC, LED | H22 |
| 240V AC, LED | M42 |
| 480V AC, LED | T82 |

③ Pilot Lamp Color Code

| Color | Code |
|-------|------|
| Amber | A |
| Green | G |
| Red | R |
| Blue | S |
| White | W |

④ Pushbutton Color Code

| Color | | Code |
|--------|-------|------|
| Top | Green | GR |
| Bottom | Red | |
| Top | White | WB |
| Bottom | Black | |

⑤ Engraving Codes

| Engraving | | Code |
|--------------|--------|------|
| No Engraving | Blank | |
| I/ON | Top | 1 |
| O/OFF | Bottom | |

Switches & Pilot Devices

Signaling Lights

Relays & Sockets

Timers

Contactors

Terminal Blocks

Circuit Breakers

Switches & Pilot Devices

Signalizing Lights

Relays & Sockets

Timers

Contactors

Terminal Blocks

Circuit Breakers

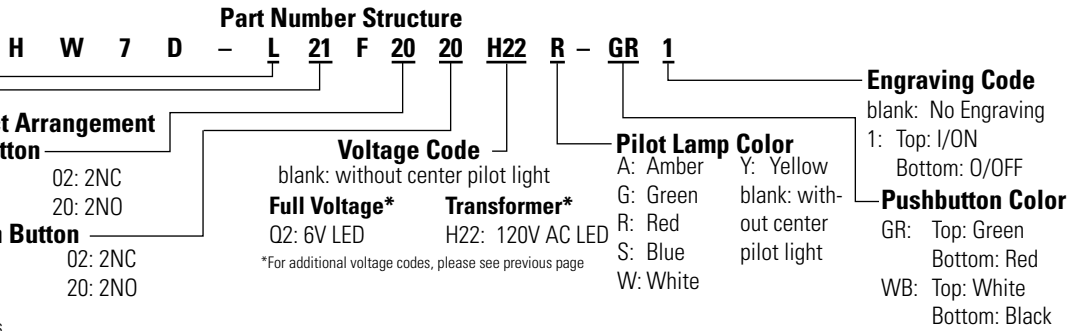

Dual Pushbutton Switches (Sub-assembled) Part Numbers



Lamp Circuit Components with Finger-Safe Terminals

| Style | Description | Part Number |
|---|---|----------------------------------|
| Lead Holder | For use with HW-CBL on all illuminated pushbutton units. One required for each deck (pair) of contacts. | HW-LH3 |
| Dummy Block with Full Voltage Adaptor | For use with odd number of contacts. | HW-DA1FBN |
| Full Voltage Adaptor | For use with even number of contacts. | TW-DA1FB |
| Transformer Unit (6V secondary voltage) | 120VAC 240VAC 480VAC | TW-F126B TW-F246B TW-F486B |

Contact Blocks

| Style | Contacts | 1NO | 1NC |
|--------------------------------|----------|------------------------------------|------------------------------------|
| Finger-Safe Spring-Up Terminal | | HW-U10-F HW-U10R-F (early make) | HW-U01-F HW-U01R-F (late break) |
| Dummy Block | | HW-DB | |

Contact Block Mounting Adaptor

| Style | Part Number |
|--------------------------------|-------------|
| Non-illuminated | HW-CB2C |
| Illuminated (with Pilot Light) | HW-CBL |

- Used to mount contact blocks to operator (first pair only).
- IEC strongly recommends using the safety lever lock (included) to prevent heavy vibration or maintenance personnel from inadvertently unlocking contacts.

Safety Lever Lock

| Style | Part Number |
|-------|-------------|
| | HW9Z-LS |

Anti-Rotation Ring

| Appearance | Part Number |
|------------|-------------|
| | HW9Z-RL |

Use with notched panel cutout to prevent unit rotation.

Engraving Codes

| Engraving | Code |
|--------------|--------|
| No Engraving | Blank |
| I/ON | Top |
| O/OFF | Bottom |

Lamps/Lens

| Style | Voltage | Part Number |
|-----------------|-----------|-------------|
| LED | 6V AC/DC | LSTD-6Ⓞ |
| | 12V AC/DC | LSTD-1Ⓞ |
| | 24V AC/DC | LSTD-2Ⓞ |
| | 120V AC | LSTD-H2Ⓞ |
| Non-illuminated | 240V AC | LSTD-M4Ⓞ |
| | | HW9Z-B7B |
| Illuminated | | HW9Z-L7W |

- In place of Ⓞ, specify the LED Color Code.
- The LED contains a current-limiting resistor and reverse polarity protection diodes.

LED Color Code

| Color | Code | Color | Code |
|-------|------|-------|------|
| Amber | A | Blue | S |
| Green | G | White | W |
| Red | R | | |

Operators

| Style | Button | Part Number |
|-----------|-------------------|-------------|
| Momentary | Flush (top) | HW7D-*11Ⓞ-Ⓞ |
| | Flush (bottom) | |
| | Flush (top) | HW7D-*12Ⓞ-Ⓞ |
| | Extended (bottom) | |
| Interlock | Flush (top) | HW7D-*21Ⓞ-Ⓞ |
| | Flush (bottom) | |
| | Flush (top) | HW7D-*22Ⓞ-Ⓞ |
| | Extended (bottom) | |

Instead of * insert:
B: Non-illuminated
L: Illuminated

Pushbutton Color Code

| Color | Code | Color | Code |
|-------------|------|---------------|------|
| Top: Green | GR | Top: White | WB |
| Bottom: Red | | Bottom: Black | |

Contact Arrangement Chart

Contact Block Mounting Position Example

| Contact Arrangement | | | Contact Block | | Top Button | | Bottom Button | | |
|---------------------|---------------|--------------|-------------------|-------|------------|------|---------------|------|---|
| Top Button | Bottom Button | Contact Code | Mounting Position | Type | Normal | Push | Normal | Push | |
| 1NO | 1NO | 1010 | 1 | NO | | X | | | |
| | | | 2 | NO | | | | X | |
| 1NO | 1NC | 1001 | 1 | NO | | X | | | |
| | | | 2 | NC | | | X | | |
| 1NC | 1NO | 0110 | 1 | NC | X | | | | |
| | | | 2 | NO | | | | X | |
| 1NC | 1NC | 0101 | 1 | NC | X | | | | |
| | | | 2 | NC | | | X | | |
| 1NO | 2NO | 1020 | 1 | NO | | X | | | |
| | | | 2 | NO | | | | X | |
| | | | 3 | Dummy | | | | | |
| | | | 4 | NO | | | | | X |
| 1NO | 1NO-1NC | 1011 | 1 | NO | | X | | | |
| | | | 2 | NO | | | | X | |
| | | | 3 | Dummy | | | | | |
| | | | 4 | NC | | | | X | |
| 1NO | 2NC | 1002 | 1 | NO | | X | | | |
| | | | 2 | NC | | | X | | |
| | | | 3 | Dummy | | | | | |
| | | | 4 | NC | | | | X | |
| 1NC | 2NO | 0120 | 1 | NC | X | | | | |
| | | | 2 | NO | | | | X | |
| | | | 3 | Dummy | | | | | |
| | | | 4 | NO | | | | | X |
| 1NC | 1NO-1NC | 0111 | 1 | NC | X | | | | |
| | | | 2 | NO | | | | X | |
| | | | 3 | Dummy | | | | | |
| | | | 4 | NC | | | | X | |
| 1NC | 2NC | 0102 | 1 | NC | X | | | | |
| | | | 2 | NC | | | X | | |
| | | | 3 | Dummy | | | | | |
| | | | 4 | NC | | | | X | |
| 2NO | 1NO | 2010 | 1 | NO | | X | | | |
| | | | 2 | NO | | | | X | |
| | | | 3 | NO | | X | | | |
| | | | 4 | Dummy | | | | | |
| 2NO | 1NC | 2001 | 1 | NO | | X | | | |
| | | | 2 | NC | | | X | | |
| | | | 3 | NO | | X | | | |
| | | | 4 | Dummy | | | | | |
| 1NO-1NC | 1NO | 1110 | 1 | NO | | X | | | |
| | | | 2 | NO | | | | X | |
| | | | 3 | NC | X | | | | |
| | | | 4 | Dummy | | | | | |
| 1NO-1NC | 1NC | 1101 | 1 | NO | | X | | | |
| | | | 2 | NC | | | X | | |
| | | | 3 | NC | X | | | | |
| | | | 4 | Dummy | | | | | |

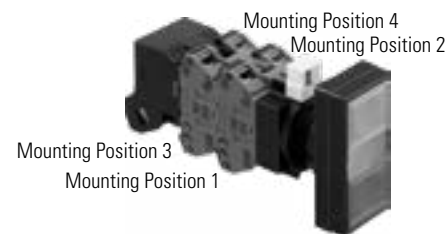

Switches & Pilot Devices

Signaling Lights

Relays & Sockets

Timers

Contactors

Terminal Blocks

Circuit Breakers

1. Transformers can have two or four contact blocks only.
 2. Contact blocks 1 and 3 are actuated by the top button. Contact blocks 2 and 4 are actuated by the bottom button.

Contact Arrangement Chart (con't)

| Contact Arrangement | | | Contact Block | | Top Button | | Bottom Button | |
|---------------------|---------------|--------------|-------------------|-------|------------|------|---------------|------|
| Top Button | Bottom Button | Contact Code | Mounting Position | Type | Normal | Push | Normal | Push |
| 2NC | 1NO | 0210 | 1 | NC | X | | | |
| | | | 2 | NO | | | X | |
| | | | 3 | NC | X | | | |
| | | | 4 | Dummy | | | | |
| 2NC | 1NC | 0201 | 1 | NC | X | | | |
| | | | 2 | NC | | | X | |
| | | | 3 | NC | X | | | |
| | | | 4 | Dummy | | | | |
| 2NO | 2NO | 2020 | 1 | NO | | X | | |
| | | | 2 | NO | | | | X |
| | | | 3 | NO | | X | | |
| | | | 4 | NO | | | | X |
| 2NO | 1NO-1NC | 2011 | 1 | NO | | X | | |
| | | | 2 | NO | | | | X |
| | | | 3 | NO | | X | | |
| | | | 4 | NC | | | | X |
| 2NO | 2NC | 2002 | 1 | NO | | X | | |
| | | | 2 | NC | | | | X |
| | | | 3 | NO | | X | | |
| | | | 4 | NC | | | | X |
| 1NO-1NC | 2NO | 1120 | 1 | NO | | X | | |
| | | | 2 | NO | | | | X |
| | | | 3 | NC | X | | | |
| | | | 4 | NO | | | | X |
| 1NO-1NC | 1NO-1NC | 1111 | 1 | NO | | X | | |
| | | | 2 | NO | | | | X |
| | | | 3 | NC | X | | | |
| | | | 4 | NC | | | | X |
| 1NO-1NC | 2NC | 1102 | 1 | NO | | X | | |
| | | | 2 | NC | | | | X |
| | | | 3 | NC | X | | | |
| | | | 4 | NC | | | | X |
| 2NC | 2NO | 0220 | 1 | NC | X | | | |
| | | | 2 | NO | | | | X |
| | | | 3 | NC | X | | | |
| | | | 4 | NO | | | | X |
| 2NC | 1NO-1NC | 0211 | 1 | NC | X | | | |
| | | | 2 | NO | | | | X |
| | | | 3 | NC | X | | | |
| | | | 4 | NC | | | | X |
| 2NC | 2NC | 0202 | 1 | NC | X | | | |
| | | | 2 | NC | | | | X |
| | | | 3 | NC | X | | | |
| | | | 4 | NC | | | | X |

Contact Block Mounting Position Example

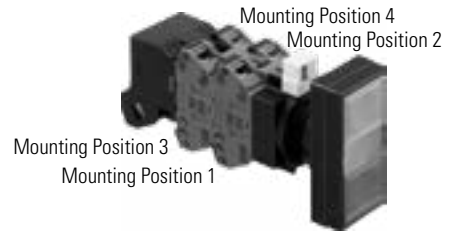

Contactor Reset Button



Reset Buttons (Assembled)

| | Plastic Bezel | Metal Bezel |
|--------------|--------------------|--------------------|
| (Blank) | HW1B-M1RS-⊙T | HW4B-M1RS-⊙T |
| Engraved "R" | HW1B-M1RS-⊙T-ENG-R | HW4B-M1RS-⊙T-ENG-R |

- 1. In place of ⊙ specify Button Color Code.
- 2. 130mm (5.1") overall length.
- 3. 16mm flat base for easy alignment

⊙ Button Color Code

| Color | Code | Color | Code |
|-------|------|--------|------|
| Black | B | White | W |
| Green | G | Yellow | Y |
| Red | R | | |
| Blue | S | | |

Contactor Reset Button (Sub-assembled)



Rod

| Style | Part Number |
|---|----------------|
|  | HW9Z-RS-TK2141 |

Button

| Style | Part Number |
|---|-------------|
|  | HW1A-B1-⊙ |

Operator

| Style | Plastic | Metal |
|---|---------|---------|
|  | HW1B-M0 | HW4B-M0 |
|  | | |

 In place of ⊙, specify the Button Color Code from table.

⊙ Button Color Code

| Color | Code | Color | Code |
|-------|------|--------|------|
| Black | B | White | W |
| Green | G | Yellow | Y |
| Red | R | | |
| Blue | S | | |

Nameplates - HW Series

| | HWAM-Black Plastic | HWAQ-Black Plastic | HWAS-Black Plastic | HWAV-Yellow Plastic |
|--|--------------------|--------------------|--------------------|-----------------------|
| | | | | |
| Nameplate (blank engraving plate included) | HWAM-OB | HWAQ-OB | HWAS-OB | HWAV-0 HWAV5-0† |
| Nameplate (engraved) | HWAM-⓪ | HWAQ-⓪ | HWAS-⓪ | HWAV-27* HWAV5-27† |
| Additional Insert (blank) | HWNP-0 | HWNP-0 | HWNP Dimensions | |
| Additional Insert (engraved) | HWNP-⓪ | HWNP-⓪ | | |

- 1. In place of ⓪, insert either the standard legend code from table below or custom engraving delimited by " ".
- 2. Standard engravings are available at no charge.
- 3. * HWAV-27 comes engraved "Emergency Stop" as shown in drawing.
- 4. † HWAV5-27 and HWAV5-0 for 60mm diameter E-Stops (80mm diameter nameplate).

Standard Legend Codes

| Pushbuttons | | | | Pushbuttons/Selector Switches | | | | Selector Switches | |
|-------------|------|---------------|------|-------------------------------|------|-------------------|------|-------------------|------|
| Legend | Code | Legend | Code | Legend | Code | Legend | Code | Legend | Code |
| AUTO | 101 | OPEN | 116 | AUTO-MAN | 201 | REV-FOR | 216 | AUTO-MAN-OFF | 301 |
| CLOSE | 102 | OUT | 117 | CLOSE-OPEN | 202 | RUN-JOG | 217 | AUTO-OFF-MAN | 302 |
| DOWN | 103 | RAISE | 118 | DOWN-UP | 203 | RUN-SAFE | 218 | CLOSE-OFF-OPEN | 303 |
| EMERG.STOP | 104 | RESET | 119 | FAST-SLOW | 204 | SAFE-RUN | 219 | DOWN-OFF-SLOW | 304 |
| FAST | 105 | REVERSE | 120 | FOR-REV | 205 | SLOW-FAST | 220 | FAST-OFF-SLOW | 305 |
| FORWARD | 106 | RUN | 121 | HAND-AUTO | 206 | START-STOP | 221 | FOR-OFF-REV | 306 |
| HAND | 107 | SLOW | 122 | HIGH-LOW | 207 | STOP-START | 222 | LEFT-OFF-RIGHT | 307 |
| HIGH | 108 | START | 123 | JOG-RUN | 208 | UP-DOWN | 223 | LOWER-OFF-RAISE | 308 |
| IN | 109 | STOP | 125 | LEFT-RIGHT | 209 | OI (Int'l OFF ON) | 250 | OFF-MAN-AUTO | 309 |
| INCH | 110 | TEST | 126 | LOWER-RAISE | 210 | | | OFF-SLOW-FAST | 310 |
| JOG | 111 | UP | 127 | MAN-AUTO | 211 | | | OFF-1-2 | 311 |
| LOW | 112 | I (Int'l On) | 150 | OFF-ON | 212 | | | OPEN-OFF-CLOSE | 312 |
| LOWER | 113 | O (Int'l Off) | 151 | ON-OFF | 213 | | | SLOW-OFF-FAST | 313 |
| OFF | 114 | EMO | 152 | OPEN-CLOSE | 214 | | | SUMMER-OFF-WINTER | 314 |
| ON | 115 | | | RAISE-LOWER | 215 | | | UP-OFF-DOWN | 315 |
| | | | | | | | | 1-OFF-2 | 316 |
| | | | | | | | | HAND-OFF-AUTO | 317 |

- 1. To order engraved nameplates, add legend code to nameplate part number.
- 2. Character height based on the number of characters and size of nameplate. Standard character size is 3/16".
- 3. Nameplates with standard legends are the same list price as blank nameplates.
- 4. Nameplates have built-in anti-rotation feature for use with notched panel cut-outs. Additional anti-rotation ring (HW9Z-RL) is not necessary.

Nameplates Order Form – HW Series

Copy this order form and use it to specify Letter Height, Custom Engravings, Location of Engraving on Nameplate, and Quantity Desired.

To ensure engraving accuracy, fax it to your IDEC representative or Distributor.

Your Company: _____
 Name: _____
 Telephone: _____
 Fax & Email: _____

IDEC Rep/Distributor Contact: _____
 PO number (if known): _____
 IDEC Rep/Distributor Phone: _____
 IDEC Rep/Distributor Fax & Email: _____

HWAM Nameplate

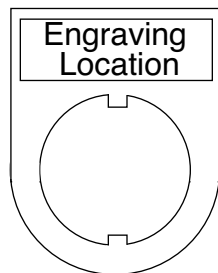

Step 1.
Choose Letter Size - 7/64" or 1/8".
 Check the box for the letter size you want. Then write your lettering in box below the check boxes. Note: 1/8" size letters cannot exceed 9 characters.

7/64" Letter Size 11 characters maximum (for 7/64" size letters)
 1/8" Letter Size 9 characters maximum (for 7/8" size letters)

Step 2.
Specify Quantity.
 Enter the number of nameplates desired in the box on the right.

Qty

1 2 3 4 5 6 7 8 9 10 11

Sample Letter Sizes
 7/64" Letters: A B C D
 1/8" Letters: A B C D

HWAQ Nameplate

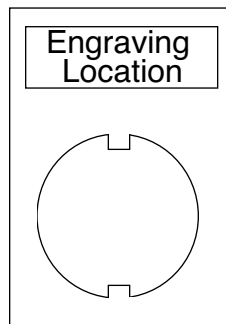

Step 1.
Choose Letter Size - 7/64" or 1/8".
 Check the box for the letter size you want. Then write your lettering in box below the check boxes. Note: 1/8" size letters cannot exceed 9 characters.

7/64" Letter Size 11 characters maximum (for 7/64" size letters)
 1/8" Letter Size 9 characters maximum (for 1/8" size letters)

Step 2.
Specify Quantity.
 Enter the number of nameplates desired in the box on the right.

Qty

1 2 3 4 5 6 7 8 9 10 11

Sample Letter Sizes
 7/64" Letters: A B C D
 1/8" Letters: A B C D

HWAS Nameplate

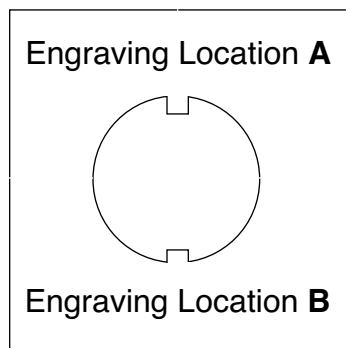

Step 1.
Choose Letter Size - 3/32" or 1/8".
 Check the box for the letter size you want. Then write your lettering in box below the check boxes. Note: 1/8" size letters cannot exceed 14 characters.

3/32" Letter Size 20 characters maximum (for 3/32" size letters)
 1/8" Letter Size 14 characters maximum (for 1/8" size letters)

Step 2.
Specify Quantity.
 Enter the number of nameplates desired in the box on the right.

Qty

A 1 2 3 4 5 6 7 8 9 10 11 12 13 14 15 16 17 18 19 20

Step 3.
Specify Location.
 Enter the location of engraving (A or B or Both), in box on the right.

Location

B 1 2 3 4 5 6 7 8 9 10 11 12 13 14 15 16 17 18 19 20

Sample Letter Sizes
 3/32" Letters: A B C D
 1/8" Letters: A B C D

Switch Engraving Order Form – HW Series

Copy this order form and use it to specify Letter Height, Maximum Number of Lines and Text to be engraved.

To ensure engraving accuracy, fax it to your IDEC representative or Distributor.

Your Company: _____
 Name: _____
 Address: _____
 PO: _____

Telephone: _____
 Fax: _____
 Email: _____
 Part Number to be Engraved: _____

Please check one of the boxes below to indicate your choice of engraving options:

ø29mm, ø40mm Mushroom Head

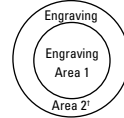

| | # of Lines | Letter Height | Max. Characters Per Line |
|--------------------------|------------|---------------|--------------------------|
| <input type="checkbox"/> | 1 | 5/32 | 5 |
| <input type="checkbox"/> | | 1/8 | 6 |
| <input type="checkbox"/> | 2 | 5/32 | 5 |
| <input type="checkbox"/> | | 1/8 | 6 |
| <input type="checkbox"/> | 3 | 1/8 | 6 |
| <input type="checkbox"/> | 4 | 3/32 | 5 |

| | # of Lines | Letter Height | Max. Characters Per Line |
|--------------------------|------------|---------------|--------------------------|
| <input type="checkbox"/> | 1 | 5/32 | 5 |
| <input type="checkbox"/> | | 1/8 | 5 |
| <input type="checkbox"/> | 2 | 5/32 | 5 |
| <input type="checkbox"/> | | 1/8 | 6 |
| <input type="checkbox"/> | 3 | 1/8 | 5 |
| <input type="checkbox"/> | 4 | 3/32 | 5 |

| | | # of Lines | Letter Height | Max. Characters Per Line |
|--------------------------|------------------|------------|---------------|--------------------------|
| <input type="checkbox"/> | Engraving Area 1 | 1 | 5/32 | 5 |
| <input type="checkbox"/> | | | 1/8 | 5 |
| <input type="checkbox"/> | Engraving Area 2 | 1 | 5/32 | 7 |
| <input type="checkbox"/> | | | 1/8 | 7 |



- Above mentioned specifications hold true for standard size pushbuttons (round and square).
- *Engraving Area 2 can be engraved for 40mm mushroom Head non-Illuminated push button only.
- Engraving is done on the button itself for non-Illuminated push buttons and on marking plate for illuminated push buttons and pilot lights.
- Please enter text exactly how you want it engraved, take care to emphasize capital or small letters.

Enter text to be engraved:

Sample Letter Sizes

1/8 Letters: **OPEN**

5/32 Letters: **OPEN**

Line 1: _____
 Line 2: _____
 Line 3: _____
 Line 4: _____

For IDEC Internal Use Only:
 Work Order #: _____

Accessories

| Item | Appearance | Description/Usage | Part Number | |
|-----------------------------------|---|--|--|----------|
| Locking Ring Wrench |  | Metallic tool used to tighten the plastic locking ring when installing the HW series in a panel | MW9Z-T1 | |
| Lamp/LED Removal Tool |  | Rubber tool makes lamp/LED removal easier. | OR-55 | |
| Anti-Rotation Ring |  | Prevents rotation of switches in panel. (included with all assembled switches except pilot lights) | for notched panel cutout (standard) | HW9Z-RL |
| | | | for round panel cutout | LW9Z-L |
| Rubber Mounting Hole Plug |  | Black rubber plug fills unused 7/8" mounting holes in panel. | OB-31 | |
| Metallic Mounting Hole Plug |  | For plugging unused 7/8" mounting holes in the panel. Tighten the attached locking ring to a torque of 12 kfg-cm maximum Degree of protection: IP66 | LW9Z-BM | |
| Pushbutton Clear Boot |  | Used to cover and protect pushbuttons Operating temperature: -50 to +60°C | Flush Pushbuttons | OC-31 |
| | | | Extended Pushbuttons | OC-32 |
| Padlock Cover |  | Plastic hinged padlockable cover to protect pushbuttons or selector switches. (Not intended for E-Stops) Degree of protection: IP65 | HW9Z-KL1 | |
| Tab Terminal Adapter |  | Tab #250 (6.35 x 0.8mm): Single tab | TW-FA4 | |
| Mounting Adaptor |  | Used to mount round HW series (except Jumbo Mushroom, unibody, and square units) into a larger panel cut-out. (includes both pieces) | 22 to 30mm | HW9Z-A30 |
| | | | 22 to 25mm | HW9Z-A25 |
| Replacement Safety Lever Lock |  | Used to prevent contact mounting lever from moving due to heavy vibration or panel maintenance. | HW9Z-LS | |
| Reset Rod for Contactors Overload |  | 5" rod used with HW1B-M0. | HW9Z-RS-TK2141 | |
| Replacement Operator Washer |  | Provided with operator. Insert between bezel and locking ring. | HWM-WASHER | |
| Replacement Locking Ring |  | Plastic locking nut comes with all HW operators & assemblies. | Standard (plastic) | HW9Z-LN |
| | | | Optional (metal) | HW9Z-LNM |
| Switch Cover (Square) |  | Used only with round or square flush pushbuttons. | HW9Z-K1 (spring return) HW9Z-K11 (maintained cover) | |
| Replacement Keys |  | Pair of Keys (#231) | HW9Z-SKP | |
| Replacement Lens |  | HW Illuminated Unibody Replacement Lens | HWLV-LENSR | |

Switches & Pilot Devices

Signaling Lights

Relays & Sockets

Timers

Contactors

Terminal Blocks

Circuit Breakers

Switches & Pilot Devices



Signaling Lights



Relays & Sockets

Timers

| Item | Appearance | Description/Usage | Part Number | |
|---|--|---|--|--|
| Replacement Jumbo Dome Lens |  | Polycarbonate Replacement Lens (If using yellow lens, use white LED.) | HW1A-P5Ⓞ Ⓞ = (A, G, R, S, W, Y) | |
| Replacement Jumbo LED Diffusing Lens |  | | HW9Z-PP5C | |
| Replacement LED Lamps for HW Jumbo Dome |  | Replacement LED Lamp - applicable for jumbo pilot lights only | LSTD8-2Ⓞ Ⓞ = (A, G, R, S, W) | |
| Rubber Cover for Dual Pushbuttons |  | Clear Silicon rubber cover | HW9Z-D7D | |
| Barrier for Dual Pushbuttons |  | Plastic barrier. Used when mounting the HW7 units on 30mm horizontal centers, to prevent possible interconnections between adjoining terminals. | HW-VU1 | |
| EMO Sticker |  | Emergency stop nameplate sticker | HW9Z-EMO-NP-TK2120 | |
| Contact Blocks (with side entry) |  | These contacts are applicable for wires terminated by ring, fork, terminals, not recommended for bare wire connections. | 1NC | 1NO |
| | | | HW-U01 HW-U01-MAU HW-U01R HW-U01R-MAU (with side entry) | HW-U10 HW-U10-MAU HW-U10R HW-U10R-MAU (with side entry) |
| Contact Blocks (without side entry) |  | These contacts are applicable for wires terminated by ring, fork, or ferule terminals, and also bare wire connections. | HW-U01-F HW-U01-MAU-F HW-U01R-F HW-U01R-MAU-F (no side entry) | HW-U10-F HW-U10-MAU-F HW-U10R-F HW-U10R-MAU-F (no side entry) |

E-Stop Shrouds

| Style | Part Numbers | E-Stop Types | Applicable Standards |
|---|--------------|--------------------|---|
|  | HW9Z-KG1 | 40mm Mushroom Head | SEMI S2-0703, 12.5.1 Compliant |
|  | HW9Z-KG2 | 40mm Mushroom Head | SEMI S2-0703, 12.5.1 & SEMATECH Compliant |

| Style | Part Numbers | E-Stop Types | Applicable Standards |
|---|--------------|--------------------|--|
|  | HW9Z-KG3 | 40mm Mushroom Head | SEMI S2 Compliant (Approved by TUV) ISO 13850 |
|  | HW9Z-KG4 | 40mm Mushroom Head | SEMI S2 Compliant (Approved by TUV) & SEMATECH ISO 13850 |

Contactors

Terminal Blocks

Circuit Breakers

Contact Assemblies

Standard Contact Assemblies

For use with Non-Illuminated Pushbuttons & E-Stops

| Style | Contacts | Part Number |
|---|----------|-------------|
|  | 1NO | HW-CBF10 |
| | 1NC | HW-CBF01 |
| | 1NO/1NC | HW-CBF11 |
| | 2NO | HW-CBF20 |
| | 2NC | HW-CBF02 |
| | 2NO/2NC | HW-CBF22 |



Gold contact option is available. Add suffix "MAU" to end of part number. For example, HW-CBF20 becomes HW-CBF20-MAU.

Full Voltage Contact Assemblies

For use with Illuminated Pushbuttons.

| Style | Contacts | Part Number |
|--|----------|-------------|
|  | 1NO | HW-FL10Q0 |
| | 2NO | HW-FL20Q0 |
| | 1NO/1NC | HW-FL11Q0 |
| | 1NC | HW-FL01Q0 |
| | 2NC | HW-FL02Q0 |



Order LED separately.

Transformer Contact Assemblies

For use with Illuminated Pushbuttons.

| Style | Contacts | Part Number |
|---|------------------|--|
|  | 120V AC with LED | 1NO HW-FL10H2-Ⓞ 2NO HW-FL20H2-Ⓞ 1NC HW-FL01H2-Ⓞ 1NO/1NC HW-FL11H2-Ⓞ |
| | 240V AC with LED | 1NO HW-FL10M4-Ⓞ 2NO HW-FL20M4-Ⓞ 1NC HW-FL01M4-Ⓞ 1NO/1NC HW-FL11M4-Ⓞ |
| | 480V AC with LED | 1NO HW-FL10T8-Ⓞ 2NO HW-FL20T8-Ⓞ 1NC HW-FL01T8-Ⓞ 1NO/1NC HW-FL11T8-Ⓞ |



- In place of Ⓞ, specify the LED Color Code.
Ⓞ = A, G, R, S, or W
- 6V LED included.

Dimensions (mm)

Non-Illuminated Pushbuttons

Flush (HW1B-M1, -A1)



Extended (HW1B-M2, -A2)

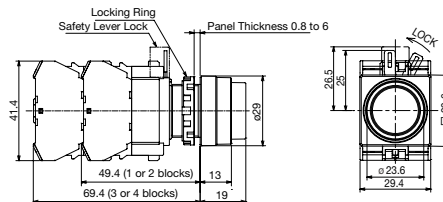

ø29mm Mushroom (HW1B-M3 -A3)

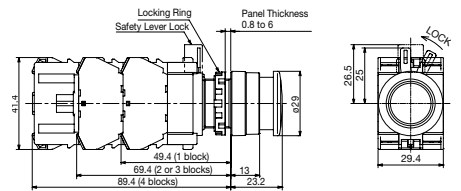

ø40mm Mushroom (HW1B-M4, -A4)

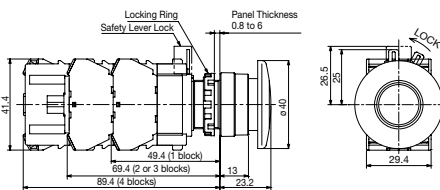

ø60mm Mushroom (HW1B-M5)

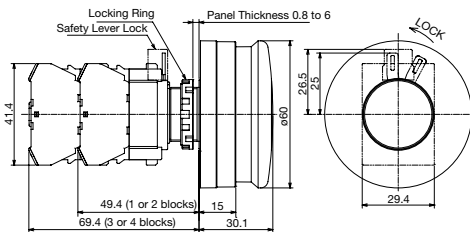

Square Flush (HW2B-M1, -A1)

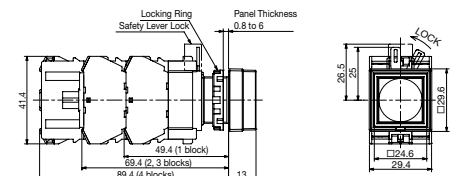

Square Extended (HW2B-M2, -A2)

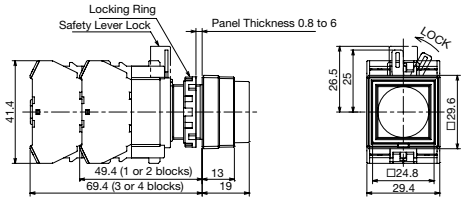

Contact Block (Bottom View)

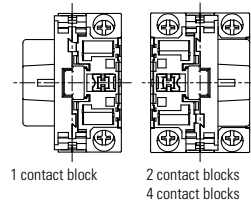

Terminal Wiring

Arrows indicate access directions for wiring

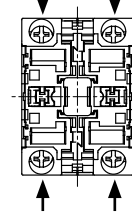

Operators

Dimensions (mm)

Flush (Round & Square)

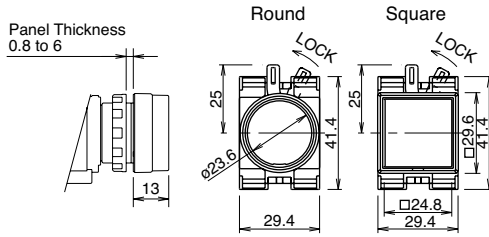

Extended

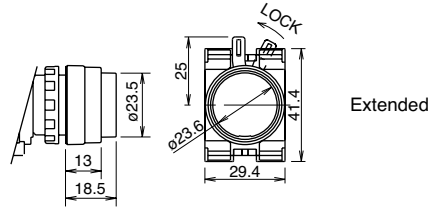

Extended with Full Shroud

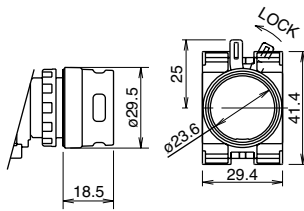

ø40mm Mushroom

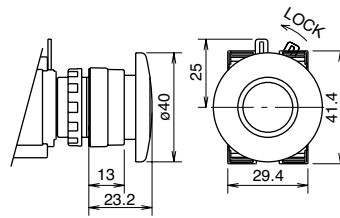

Emergency Stop Pushbuttons

Dimensions (mm)

ø29mm Head Pushlock Turn Reset (HW1B-V3)

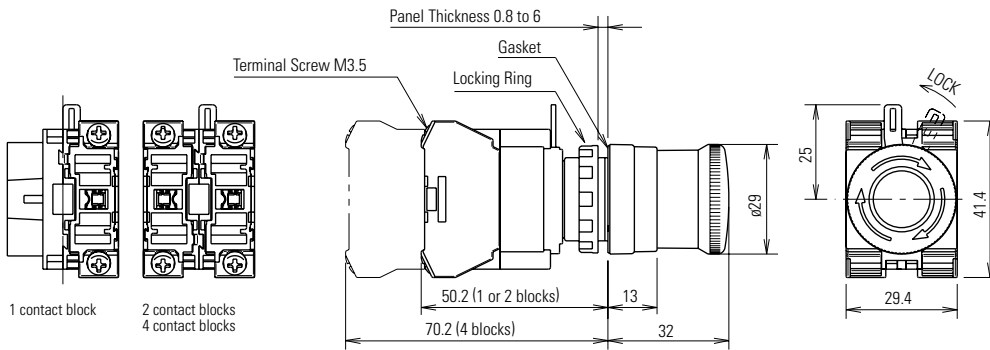

ø40mm Head Pushlock Turn Reset (HW1B-V4)

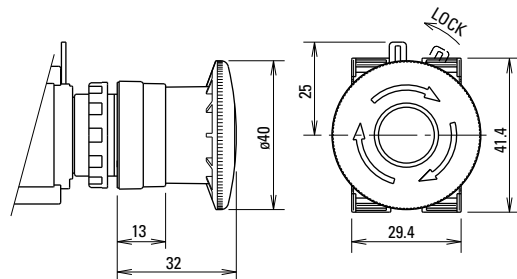

ø40mm Head EMO Pushlock Turn Reset (HW1B-V4)

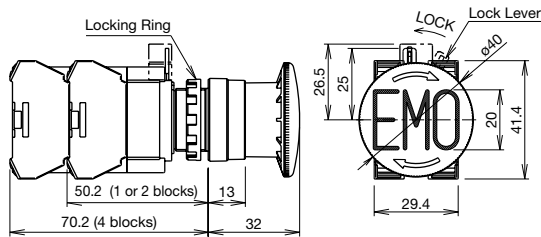

ø40mm Head Pushlock Key Reset (HW1B-X4)



ø60mm Head Pushlock Turn Reset (HW1B-V5)

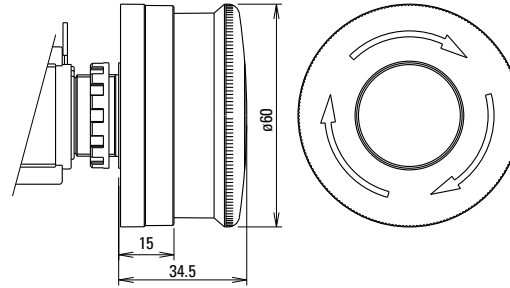

ø40mm Head Push-Pull (HW1B-Y2)

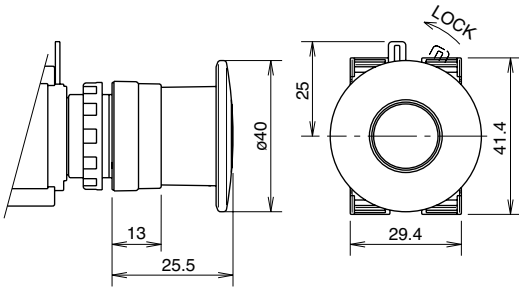

ø40mm Head Unibody Pushlock Turn Reset (HW1B-BV4)

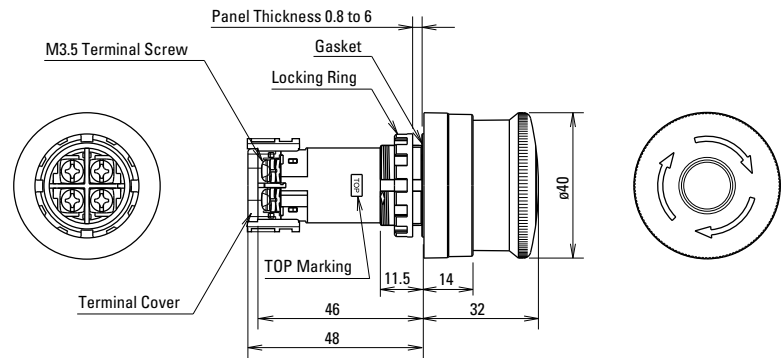

Illuminated E-Stop Pushbuttons (HW1E-LV4)

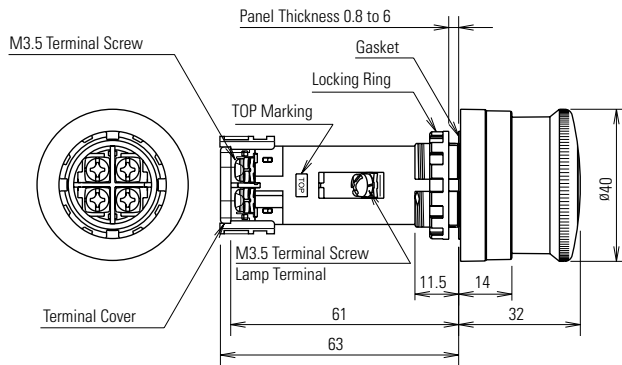

Mounting Hole

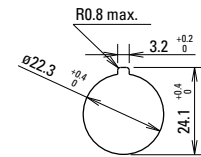

The minimum mounting centers shown below are applicable to E-Stop switches with one layer of contact blocks (two contact blocks). When two layers of contact blocks are mounted, determine the minimum mounting centers for ease of wiring.

| Unit | Vertical Spacing | Horizontal Spacing |
|---------|------------------|--------------------|
| HW1B-V3 | 50 mm | 50 mm |
| HW1B-V4 | | |
| HW1B-X4 | | |
| HW1B-Y2 | | |
| HW1B-V5 | 60 mm | 60 mm |

Terminal Arrangement (Bottom View)

HW1E-BV4



HW1E-LV4

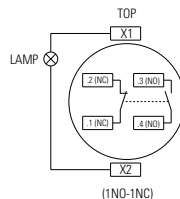

Emergency Stop Stations



| Operator | Dimension A (mm) |
|---------------------|-------------------------|
| Pushlock Turn Reset | 32 |
| Pushlock Key Reset | 32 (Key inserted: 49.4) |
| Push Pull | 25.5 |

Mounting Hole Layout

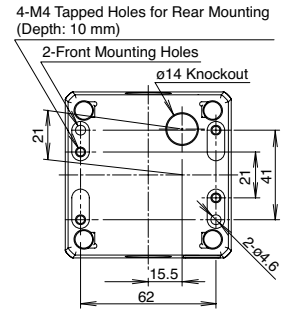

Dimensions (mm)

Pilot Lights

Round Flush Terminal screws: M3.5, integrated terminal cover

6, 12, 24V AC/DC, Without LED lamp

100/110V AC, 200/220V AC (240V AC maximum)

110V DC, 380V AC minimum

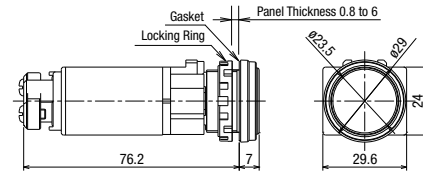
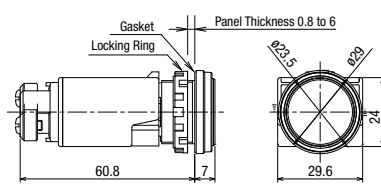
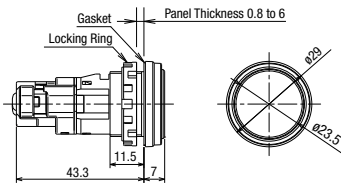

Dimensions (mm)

Extended Terminal screws: M3.5, integrated terminal cover

6, 12, 24V AC/DC, Without LED lamp

100/110V AC, 200/220V AC (240V AC maximum)

110V DC, 380V AC minimum

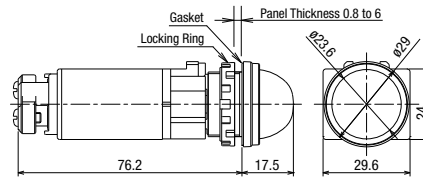
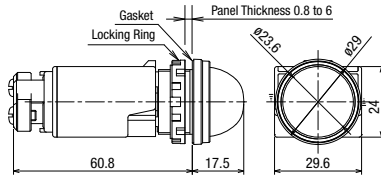
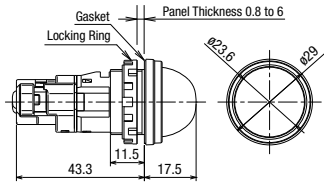

Square Flush Terminal screws: M3.5, integrated terminal cover

6, 12, 24V AC/DC, Without LED lamp

100/110V AC, 200/220V AC (240V AC maximum)

110V DC, 380V AC minimum

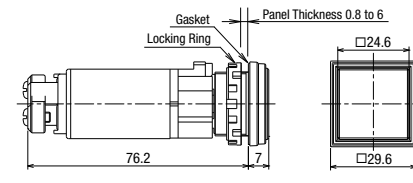

Jumbo Dome Pilot Light Terminal screws: M3.5, integrated terminal cover

Panel Thickness 1 to 5

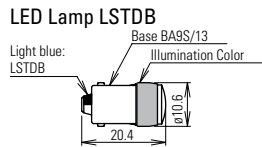
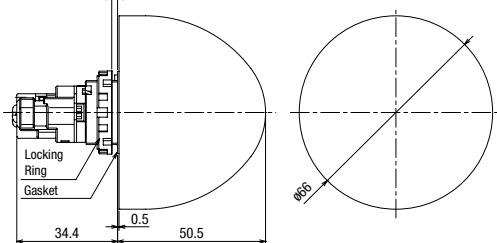

Mounting Hole Layout

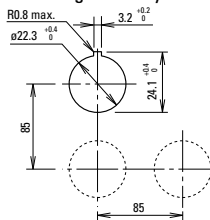

Mounting Hole Layout

Close mounting on 30mm centers
Degree of protection: IP65

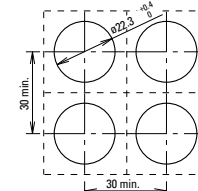

When mounting transformer or DC-DC converter type units on 30mm centers vertically and horizontally, keep the ambient temperature below 40°C.

Illuminated Pushbuttons

Full Voltage Models

1 Contact Block

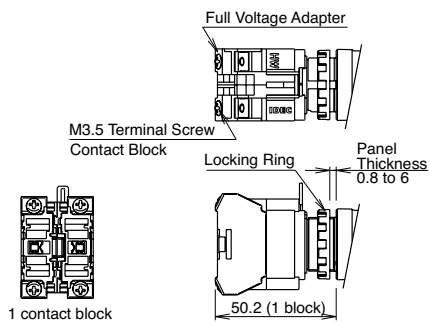

2 Contact Blocks

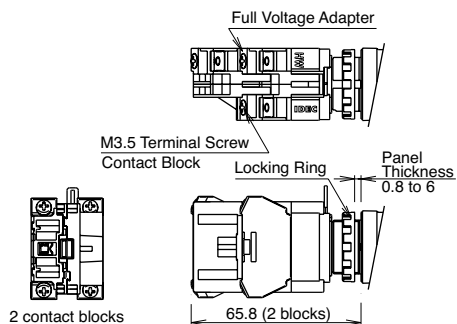

3 Contact Blocks

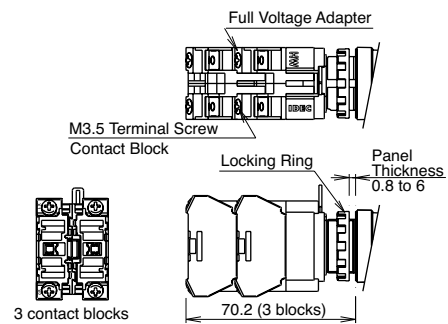

Illuminated Pushbuttons con't

4 Contact Blocks

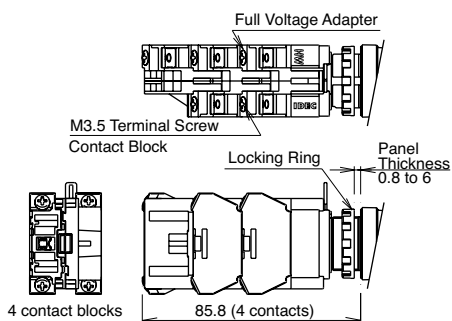

Terminal Wiring

Arrows indicate access directions for wiring.

Contact Block

Full Voltage Adaptor

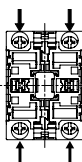

Transformer

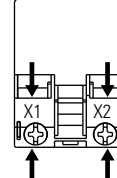

Transformer Models

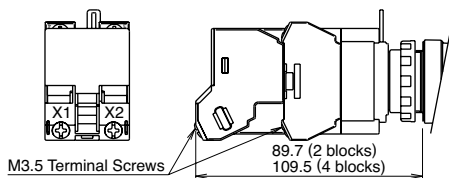

DC-DC Converter Models

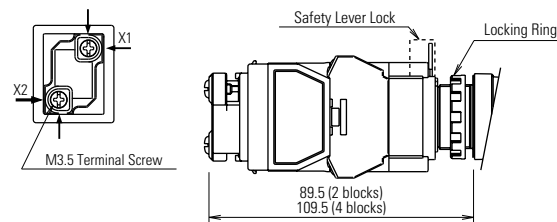

Dimensions (mm)

Non-Illuminated Selector & Key Switches

Knob Operator

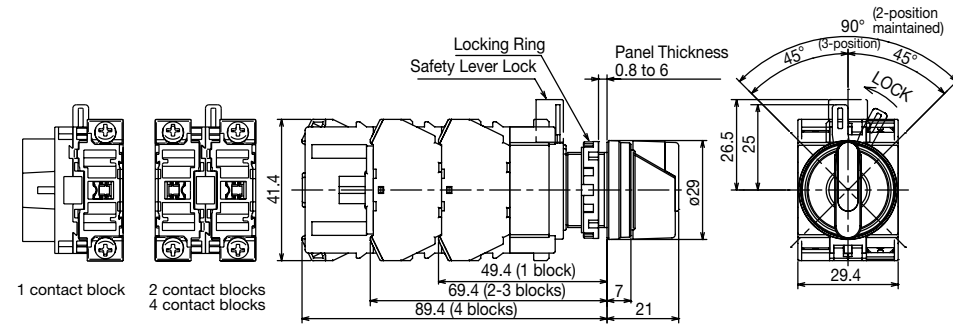

Key Operator

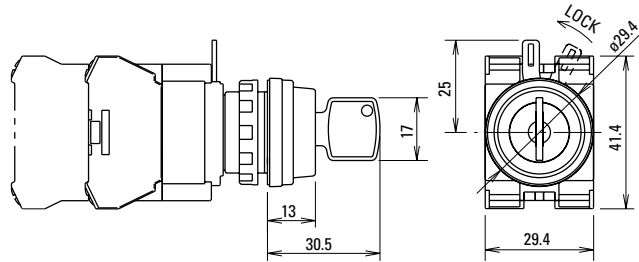

Illuminated Selector Switches

Full Voltage Model

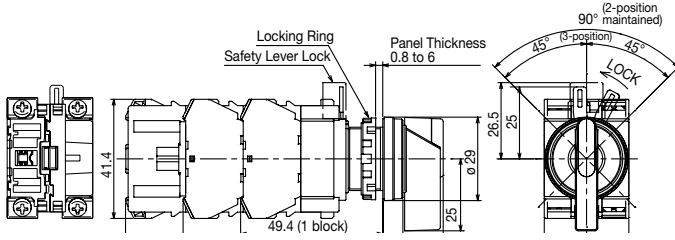

Transformer Model

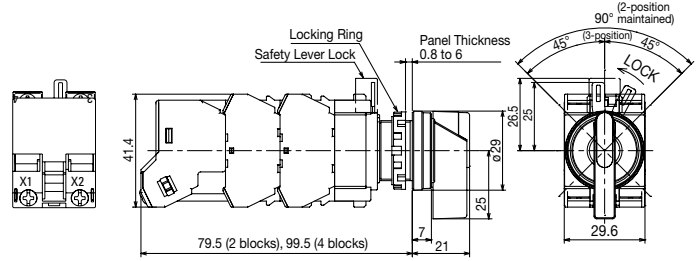

Dimensions (mm)

Terminal Wiring

Arrows indicate access directions for wiring.

Contact Block Full Voltage Adaptor

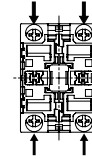

Transformer

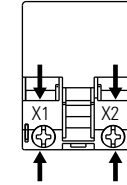

Dual Pushbutton

Without Pilot Light

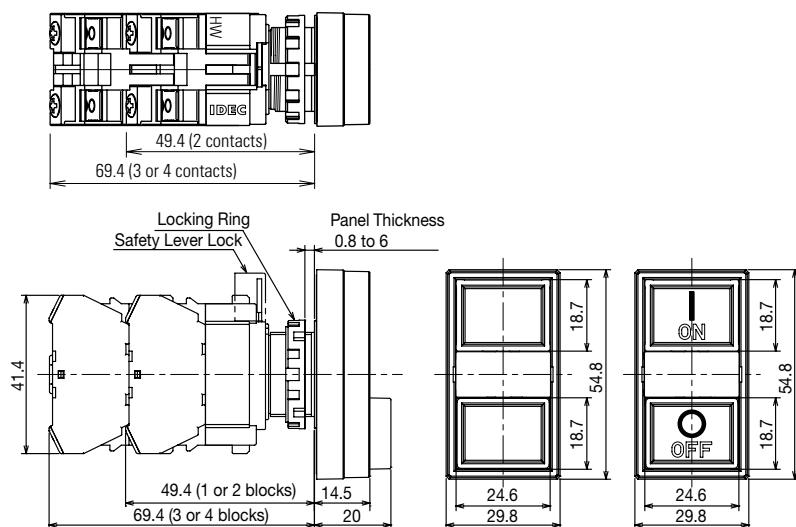

With Pilot Light

Full Voltage

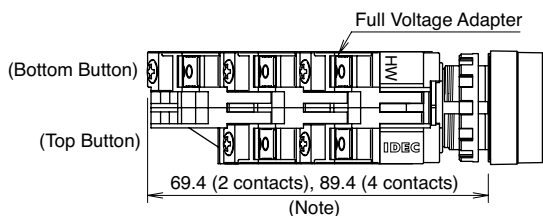

The depth of a 3-contact model depends on the combination of contact blocks at top and bottom pushbuttons.

| | | |
|---------------|------------------|------------------|
| Top Button | 1 contact block | 2 contact blocks |
| Bottom Button | 2 contact blocks | 1 contact block |
| Depth | 89.4 mm | 69.4 mm |

Transformer (240V minimum)

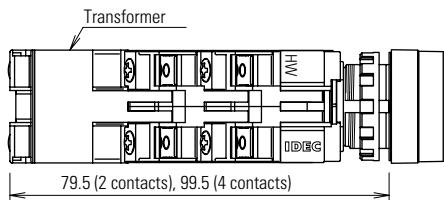

Transformer (480V)

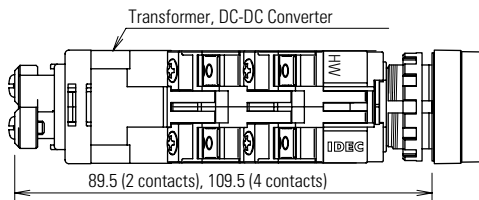

Monolever

Dimensions

Standard Lever

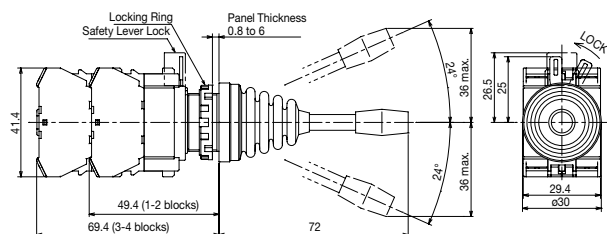

Interlocking Lever

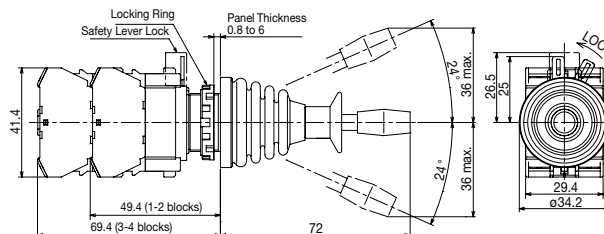

All dimensions in mm.

Terminal Screws M3.5 Integrated Terminal Cover

Dimensions (mm)

Mounting Hole Layout

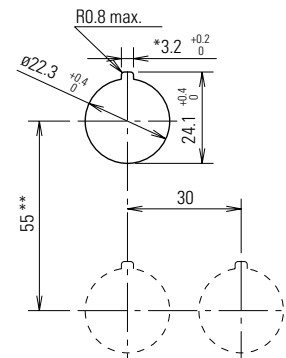

-The 3.2 mm recess is for preventing rotation and is not necessary when a nameplate or anti-rotation ring is not used.
 -When using the safety lever lock, determine the vertical spacing in consideration of convenience for installing and removing the safety lever lock.
 -Recommended vertical spacing: 100 mm
 -The minimum mounting centers are applicable to switches with one layer of contact blocks (two contact blocks). When two layers of contact blocks are mounted, determine the minimum mounting centers for ease of wiring.

Accessory Dimensions

LW9Z-BM
Metallic Mounting Hole Plug



OB-31
Rubber Mounting Hole Plug

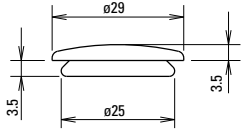

HW9Z-RL
Anti-Rotation Ring

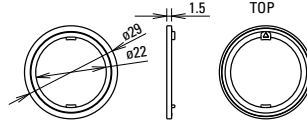

OR-55
Lamp/LED Removal Tool

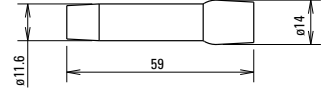

HW9Z-D7D
Dual Pushbutton Rubber Cover

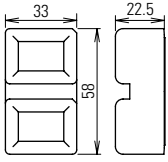

HW-VU1
Dual Pushbutton Barrier

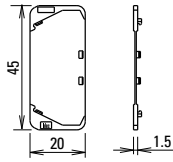

MW9Z-T1
Locking Ring Wrench

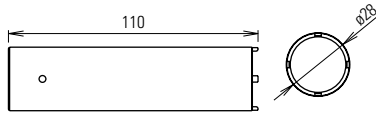

HW-VL1
Barrier

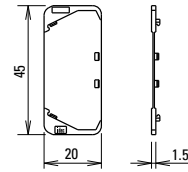

HW9Z-KL1
Padlock Cover

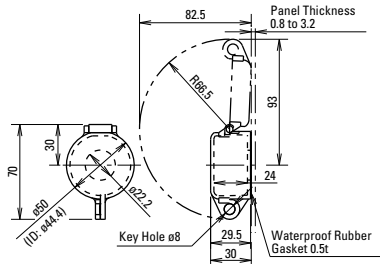

HWLS-TK1971
Safety Lever Lock

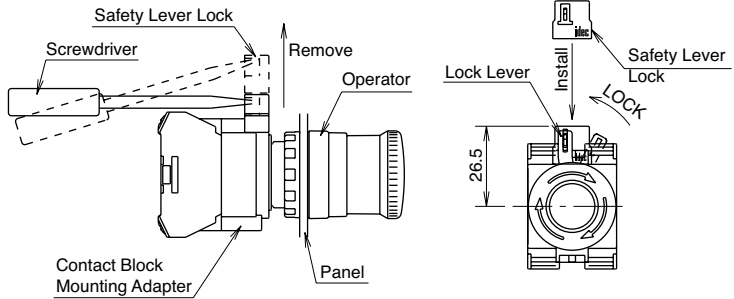

HW9Z-KG1

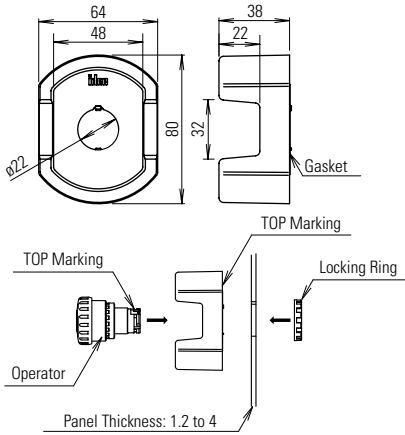

HW9Z-KG2

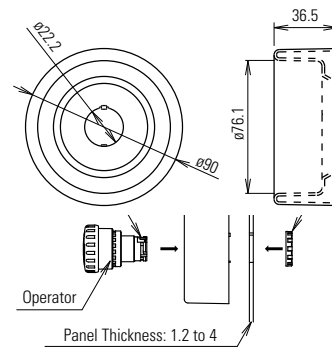

HW9Z-KG3

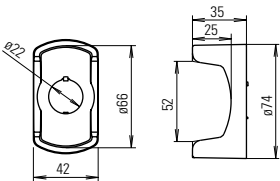

HW9Z-KG4

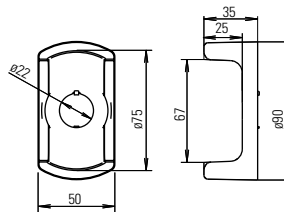

LSTD

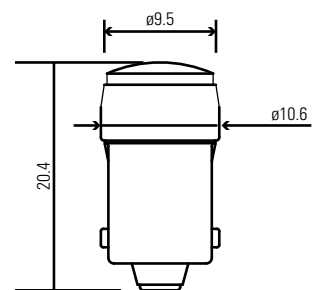

Specification Charts

INDUCTIVE

DC Voltages

| | | | |
|-----------|----|----|-----|
| Voltage V | 24 | 48 | 110 |
| Current A | 4 | 2 | 1.1 |

AC Voltages

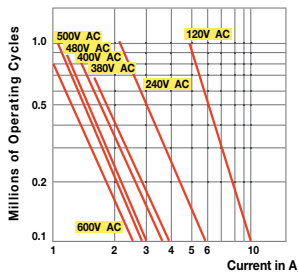

RESISTIVE

DC Voltages

| | | | |
|-----------|----|----|-----|
| Voltage V | 24 | 48 | 110 |
| Current A | 8 | 4 | 2.2 |

AC Voltages

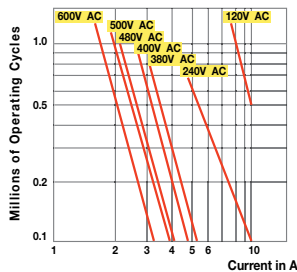

Conforming to IEC 947-5-1 Appendix C.
Utilization categories AC-15 and DC-13.
Operation rate: 1,800 op. hour
Load factor:
Inductive 0.4 ± 0.05
Resistive 0.9 ± 0.05

2 Position Selector Switches

| | Contact | Mounting Position | Operator Position | |
|------------------------------|-------------------|-------------------|-------------------|-------|
| | | | Left | Right |
| HW1S-2T HW1K-2* HW1F-2 | HW-U10-F (NO) | L | 0 | X |
| | | R | 0 | X |
| | HW-U01-F (NC) | L | X | 0 |
| | | R | X | 0 |
| | HW-U10R-F (NO-EM) | L | 0 | X |
| | | R | 0 | X |
| | HW-U01R-F (NC-LB) | L | X | 0 |
| | | R | X | 0 |

3 Position Selector Switches con't

| | Contact | Mounting Position | Operator Position | | |
|----------------------|-------------------|-------------------|-------------------|--------|-------|
| | | | Left | Center | Right |
| HW1S-3JT HW1K-3J* | HW-U10-F (NO) | L | X | 0 | 0 |
| | | R | 0 | 0 | X |
| | HW-U01-F (NC) | L | 0 | X | 0 |
| | | R | 0 | X | 0 |
| | HW-U10R-F (NO-EM) | L | X | 0 | X |
| | | R | X | 0 | X |
| | HW-U01R-F (NC-LB) | L | 0 | X | X |
| | | R | X | X | 0 |

3 Position Selector Switches

| | Contact | Mounting Position | Operator Position | | |
|------------------------------|-------------------|-------------------|-------------------|--------|-------|
| | | | Left | Center | Right |
| HW1S-3T HW1K-3* HW1F-3 | HW-U10-F (NO) | L | X | 0 | 0 |
| | | R | 0 | 0 | X |
| | HW-U01-F (NC) | L | 0 | X | X |
| | | R | X | X | 0 |
| | HW-U10R-F (NO-EM) | L | X | 0 | 0 |
| | | R | 0 | 0 | X |
| | HW-U01R-F (NC-LB) | L | 0 | X | X |
| | | R | X | X | 0 |

4 Position Selector Switches

| | Contact | Mounting Position | Operator Position | | | |
|---------|-------------------|-------------------|-------------------|---|---|---|
| | | | 1 | 2 | 3 | 4 |
| HW1S-4T | HW-U10-F (NO) | L | X | 0 | 0 | 0 |
| | | R | 0 | 0 | 0 | X |
| | HW-U01-F (NC) | L | 0 | 0 | X | 0 |
| | | R | 0 | X | 0 | 0 |
| | HW-U10R-F (NO-EM) | L | X | X | 0 | X |
| | | R | X | 0 | X | X |
| | HW-U01R-F (NC-LB) | L | 0 | X | X | X |
| | | R | X | X | X | 0 |

5 Position Selector Switches

| | Contact | Mounting Position | Operator Position | | | | |
|---------|-------------------|-------------------|-------------------|---|---|---|---|
| | | | 1 | 2 | 3 | 4 | 5 |
| HW1S-5T | HW-U10-F (NO) | L | X | 0 | 0 | 0 | 0 |
| | | R | 0 | 0 | 0 | 0 | X |
| | HW-U01-F (NC) | L | 0 | 0 | 0 | X | 0 |
| | | R | 0 | X | 0 | 0 | 0 |
| | HW-U10R-F (NO-EM) | L | X | X | X | 0 | X |
| | | R | X | 0 | X | X | X |
| | HW-U01R-F (NC-LB) | L | 0 | X | X | X | X |
| | | R | X | X | X | X | 0 |

1. Mounting position indicates which side of operator each contact should be mounted (as viewed from the front of the panel).
2. *For key removable code see page 663.

3. HW1S-3T is identified by white plungers on the operator.
4. HW1S-3ST is identified by red plungers on the operator.
5. HW1S-3JT is identified by black plungers on the operator.

HW Safety Precautions

Turn off power to HW series control units before starting installation, removal, wiring, maintenance, and inspection of the products. Failure to turn power off may cause electrical shocks or fire hazard.

To avoid the possibility of burning yourself, use the lamp holder tool when replacing lamps.

For wiring, use wires of a proper size to meet voltage and current requirements.

HW General Instructions

Panel Mounting

Remove the contact block assembly from the operator (for transformer type pilot lights, remove the transformer from the illumination unit). Remove the locking ring from the operator. Insert the operator into the panel cut-out from the front, tighten the locking ring from the back, then install the contact block assembly to the operator.

Removing and Installing the Contact Block Assembly

1. To remove the operator from the contact block, turn the locking lever in the direction of the arrow shown below. The operator can now be removed.
2. To reinstall, place the TOP markings on the operator and the contact block mounting adapter in the same direction, and insert the operator into the contact block mounting adapter. Then turn the locking lever in the opposite direction.



Safety Lever Lock

IDEC strongly recommends using the safety lever lock (HW9Z-LS, yellow) to prevent heavy vibration or maintenance personnel from unlocking the contact assembly.

1. HW series can be mounted vertically with a minimum spacing of 55 mm but spacing should be determined to ensure easy operation (recommended minimum spacing: 100 mm).
2. Mount the control unit onto the panel, lock the lever, and push in the safety lever lock to install.
3. When the spacing is narrower than the recommended value, with the lever unlocked, mount the safety lever lock and insert the contact unit to the operator. Then, lock the lever and strongly push in the safety lever lock to install.
4. To remove the safety lever lock, insert a flat screwdriver into the safety lever and push upwards.

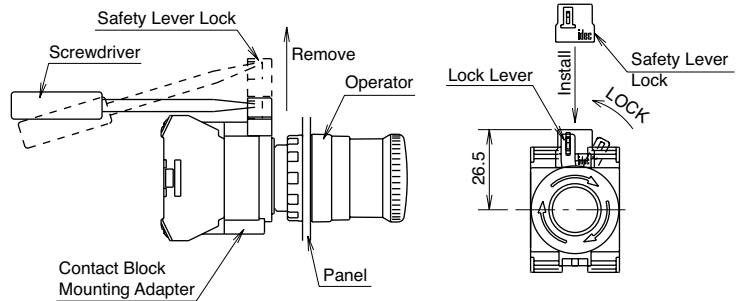

Notes for Panel Mounting

1. When mounting the operator onto a panel, use the optional locking ring wrench (MW9Z-T1) to tighten the locking ring. Tightening torque must not exceed 2.0 N·m. Do not use pliers. Excessive tightening will damage the locking ring.
2. For the contact blocks and transformers housing LED lamps, make sure not to press the lamps too hard, otherwise the lamp socket may be damaged.

Dual Pushbutton Instructions

Replacement of Lens

Removing

Remove the lens by inserting a screwdriver into the recess of the lens through the bezel.

Installing

Install the lens in the recess between the buttons by pressing against the bezel.

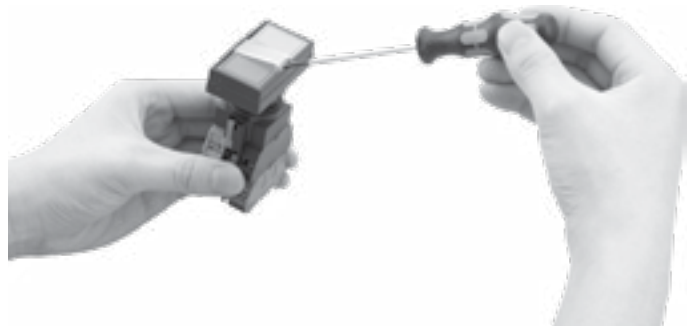

Dual Pushbuttons Instructions continued

Replacement of Lamps

LED lamps can be replaced by using the lamp holder tool (OR-55) from the front of the panel, or by removing the contact block assembly from the operator unit.

Removing the Lamps from the Front of the Panel

Removal

1. To remove, slip the lamp holder tool onto the lamp head lightly. Then push slightly, and turn the lamp holder tool counterclockwise.



Installation

1. To install, insert the lamp head into the lamp holder tool, and hold the lamp as shown in the figure below.
2. Place the pins on the lamp base to the grooves in the lamp socket. Insert the lamp and turn it clockwise.



About Dual Pushbutton Switches

The dual pushbuttons cannot be removed or replaced!

Do not attempt to remove using a flat screwdriver or pincers, otherwise the dual pushbuttons may be damaged.

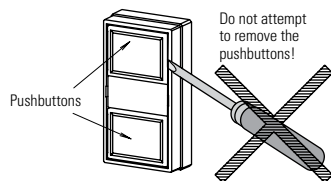

Narrow Mounting

When mounting the units closely in a horizontal row on 30mm centers, use optional barriers to prevent interconnection between adjoining terminals. The barriers can be attached simply by pressing them onto the sides of contact blocks.



When mounting transformer type illuminated units closely in a horizontal row on 30mm centers, insert solid wires or stranded wires into inside of the terminal screw on the transformer (see figure on the right) to prevent short circuit between adjoining terminals.

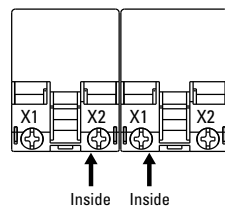

Installation of LED Illuminated Units

When using full voltage type LED illuminated units, provide protection against electrical noise, if necessary.

Applicable Wiring

The applicable wire size is 2 mm² maximum. (solid wire ø1.6mm² maximum) One or two wires can be connected.

Applicable Crimping Terminal

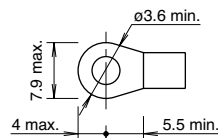

Be sure to use an insulation tube or cover on the crimping part of the crimping terminal to prevent electrical shocks.

Solid Wire

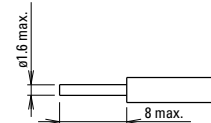

Note: When connecting wires to contact blocks or transformers in the direction shown below, keep the insulation stripping length 6.6 mm at the maximum.

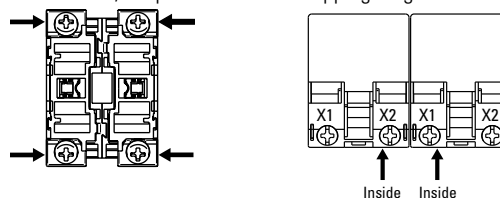

Installing the Rubber Boot

When using the HW7D pushbuttons in places where the pushbuttons are subjected to water splash or an excessive amount of dust, make sure to use the HW9Z-D7D rubber boot (IP65) which is ordered separately.

Notes for Installing the Rubber Boot

Remove the gasket from the operator, and install the rubber boot on the operator. Pull out the seals of the rubber boot and place them around the operator sleeve as shown. Make sure that the seals are not twisted or tucked inside and that the gasket does not remain, otherwise the normal waterproof and dustproof characteristics are not ensured.

1. Remove the gasket.
2. Install the rubber boot on the pushbuttons.
3. Rubber boot is installed.

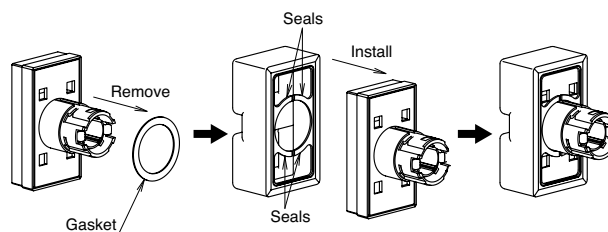

X-ON Electronics

Largest Supplier of Electrical and Electronic Components

Click to view similar products for [Switch Hardware](#) category:

Click to view products by [Idec](#) manufacturer:

Other Similar products are found below :

[893102000](#) [LZZ1A](#) [0098.9234](#) [61-9707.7](#) [61-9781.9](#) [M2PA-5011](#) [635401](#) [6PA104](#) [6PA113](#) [6PA147-E6](#) [6PA148-E6](#) [6PA32](#) [6PA9](#) [700106](#)
[700109](#) [700201A56](#) [700303A56](#) [700701264](#) [700C1GRY](#) [700C2GRN](#) [704-6001](#) [704.960.4](#) [704.960.9](#) [704.965.1](#) [704.965.2](#) [704.965.6](#)
[704.966.0](#) [7089-3](#) [71M1048](#) [757200264](#) [778000A56](#) [79215938](#) [MHU35](#) [MHU37](#) [807039-1](#) [825.003.011](#) [825.005.011](#) [825.053.011](#)
[825.055.011](#) [826.000.071](#) [827.020.011](#) [827.400.021](#) [835.900.023](#) [MML52C10C](#) [MML52E10C](#) [MML72EEK](#) [MML92HGH](#) [MML93K](#)
[84211M02CNNS](#) [84211M02LNNX3](#)