

Flush Silhouette Switches

# LW Series



Flush bezel projects only 2 mm from front of panel



• See website for details on approvals and standards.

Collective mounting is possible

Removable contact block with a locking lever enable easy installation.

Key selector switches with high-security lock mechanism

Degree of protection: IP65 (IEC 60529)

## LW SERIES

[ Bezel size ]	[ From panel front ]	[ Shape ]	[ Contact rating ]	[ Action ]	[ Operating stroke ]

Projecting only 2mm when mounted on a panel, these switches provide a sleek, updated look while maintaining the highest levels of reliability.

<p><b>Illuminated Pushbuttons</b></p> <p>Extended</p>	<p><b>Pushbuttons</b></p> <p>Extended</p>	<p><b>Pilot Light</b></p> <p>Extended</p>	<p><b>Selector Switches</b></p>	<p><b>Illuminated Selector Switches</b></p>	<p><b>Key Selector Switches</b></p>
---	---	---	---------------------------------	---	-------------------------------------

# Flush Silhouette Switches LW Series

Flush bezel projects only 2 mm from front of panel  
 ø28 round and 28-mm square black plastic bezels. Round metal bezels are also available.



APEM

Switches &amp; Pilot Lights

Control Boxes

Emergency Stop Switches

Enabling Switches

Safety Products

Explosion Proof

Terminal Blocks

Relays &amp; Sockets

Circuit Protectors

Power Supplies

LED Illumination

Controllers

Operator Interfaces

Sensors

AUTO-ID

Flush Silhouette

ø16

ø22

ø30

Miniature

Pilot Lights

CW

LW-F

LB

LBW

UP

Flush Bezel

## Specifications and Ratings

### Contact Ratings

#### Gold Contacts (switch base: blue)

Maximum Voltage	250V AC/DC	
Thermal Current	3A	
Operating Voltage	125V AC	30V DC
Operating Current (resistive load)	0.1A	0.1A
Contact Material	Gold plated silver	

Minimum applicable load (reference value): 5V AC/DC, 1 mA  
 (Applicable range is subject to the operating conditions and load.)

#### Silver Contacts (switch base: gray)

Operating Voltage		30V	125V	250V
Operating Current	AC 50/60Hz	Resistive Load	—	3A
		Inductive Load	—	2A
	DC	Resistive Load	2A	0.4A
		Inductive Load	1A	0.2A
Thermal Current		5A		
Contact Material		Silver		

AC inductive load: PF = 0.6 to 0.7  
 DC inductive load: L/R = 7 ms max.

#### Weight (Examples)

Weight (approx.)	25g (LW6MB-M1C3)	30g (LW6S-3LC3)
	22g (LW6B-M1C3)	36g (LW6MF-2C34)
	20g (LW6MP-14)	33g (LW6F-2C34)
	18g (LW6P-14)	58g (LW6MK-3C3A)
	29g (LW6ML-M1C34)	55g (LW6K-3C3A)
	26g (LW6L-M1C34)	
	33g (LW6MS-3LC3)	

### Specifications

Operating Temperature	-25 to +60°C (no freezing) Illuminated units: -25 to +50°C	
Storage Temperature	-40 to +80°C	
Operating Humidity	45 to 85% RH (no condensation)	
Contact Resistance	50 mΩ maximum (initial value)	
Insulation Resistance	100 MΩ minimum (500V DC megger)	
Dielectric Strength	Switch Unit	Between live part and ground: 2,500V AC, 1 minute Between terminals of different poles: 2,500V AC, 1 minute Between terminals of the same poles: 1,000V AC, 1 minute
	Illumination Unit (Note 4)	Between live part and ground: 2,500V AC, 1 minute
Vibration Resistance	Damage limits: 30 Hz, 1.5 mm Operating extremes: 5 to 55 Hz, amplitude 0.5 mm	
Shock Resistance	Damage limits: 1,000 m/s <sup>2</sup> (100G) Operating extremes: 100 m/s <sup>2</sup> (10G)	
Mechanical Life (minimum operations)	Momentary:	1,000,000
	Maintained:	500,000
	Selector switches:	250,000
	Illuminated selector switches:	250,000
Electrical Life (minimum operations)	Momentary:	100,000 (Note 1)
	Maintained:	100,000 (Note 2)
	Selector switches:	100,000 (Note 2)
	Illuminated selector switches:	100,000 (Note 2)
Degree of Protection	IP65 (IEC 60529)	
Terminal Style	Solder/tab terminal #110 PC board terminal Screw terminal	
Bezel Material	Metal bezel: diecast aluminum Black plastic bezel: polyamide	





Note 1: Switching frequency 1,800 operations/h  
 Note 2: Switching frequency 900 operations/h

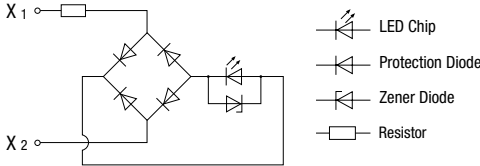

Download catalogs and CAD from <http://eu.idec.com/downloads>

## Flush Silhouette Switches LW Series

## LED Lamp Ratings

Part No.	LSTD-6 ②	LSTD-1 ②	LSTD-2 ②
Lamp Base	BA9S/13		
Rated Voltage	6V AC/DC	12V AC/DC	24V AC/DC
Voltage Range	6V AC/DC $\pm 10\%$	12V AC/DC $\pm 10\%$	24V AC/DC $\pm 10\%$
Current Draw	AC	8 mA (except S), 7 mA (S)	11 mA (except S), 9 mA (S)
	DC	7 mA (A, R), 5.5 mA (G, PW), 4.5mA (S)	10 mA (except S), 8 mA (S)
Color Code ②	A (amber), G (green), PW (pure white), R (red), S (blue) Use PW lamp for yellow (Y) illumination.		
Lamp Base Color	Same as illumination color (pure white lamp base color is gray)		
Voltage Marking	Die stamped on the base		
Life (reference value)	Approx. 50,000 hours (The luminance is reduced to 50% the initial intensity when used on complete DC at 25°C.)		
Internal Circuit	 <p>  LED Chip   Protection Diode   Zener Diode   Resistor </p>		

- Use a pure white (PW) LED lamp for yellow (Y) lens.

## Mounting Hole Layout

## Round

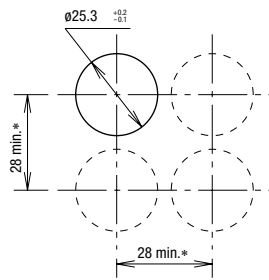

## Square

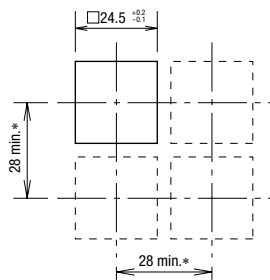

Note: Determine mounting centers to ensure easy operation.

- \* Pushbutton with switch guard: Vertical 56.5 mm, Horizontal 28 mm minimum
- \* Lever operator type selector switches: Vertical 31 mm, Horizontal 28 mm minimum
- \* Screw terminal: Vertical 40 mm, Horizontal 28 mm minimum



## Ordering Information

## Standard Units

- Specify a button or lens color code in the Part No.
- All illuminated units are supplied with an LED lamp.
- All standard units are UL recognized, CSA certified, and EN compliant (TÜV Rheinland).
- Collective mounting and PC board mount.

Round Illuminated Pushbuttons with Metal Bezel

Package Quantity: 1

Shape	Lamp	Operation	Contact Material	Contact	Part No.		
					Solder/Tab Terminal	PC Board Terminal	Screw Terminal
Round Flush with Metal Bezel LW6ML-M1 LW6ML-A1 	LED	Momentary	Gold	SPDT	LW6ML-M1C1③②	LW6ML-M1C1③V②	—
				DPDT	LW6ML-M1C2③②	LW6ML-M1C2③V②	LW6ML-M1C2③M②
				3PDT	LW6ML-M1C3③②	LW6ML-M1C3③V②	—
			Silver	SPDT	LW6ML-M1C5③②	—	—
				DPDT	LW6ML-M1C6③②	—	LW6ML-M1C6③M②
				3PDT	LW6ML-M1C7③②	—	—
		Maintained	Gold	SPDT	LW6ML-A1C1③②	LW6ML-A1C1③V②	—
				DPDT	LW6ML-A1C2③②	LW6ML-A1C2③V②	LW6ML-A1C2③M②
				3PDT	LW6ML-A1C3③②	LW6ML-A1C3③V②	—
			Silver	SPDT	LW6ML-A1C5③②	—	—
				DPDT	LW6ML-A1C6③②	—	LW6ML-A1C6③M②
				3PDT	LW6ML-A1C7③②	—	—
Round Extended with Metal Bezel LW6ML-M2 LW6ML-A2 	LED	Momentary	Gold	SPDT	LW6ML-M2C1③②	LW6ML-M2C1③V②	—
				DPDT	LW6ML-M2C2③②	LW6ML-M2C2③V②	LW6ML-M2C2③M②
				3PDT	LW6ML-M2C3③②	LW6ML-M2C3③V②	—
			Silver	SPDT	LW6ML-M2C5③②	—	—
				DPDT	LW6ML-M2C6③②	—	LW6ML-M2C6③M②
				3PDT	LW6ML-M2C7③②	—	—
		Maintained	Gold	SPDT	LW6ML-A2C1③②	LW6ML-A2C1③V②	—
				DPDT	LW6ML-A2C2③②	LW6ML-A2C2③V②	LW6ML-A2C2③M②
				3PDT	LW6ML-A2C3③②	LW6ML-A2C3③V②	—
			Silver	SPDT	LW6ML-A2C5③②	—	—
				DPDT	LW6ML-A2C6③②	—	LW6ML-A2C6③M②
				3PDT	LW6ML-A2C7③②	—	—

Color Code and Voltage Code

② Lens/LED Color Code	③ Operating Voltage Code
Specify a Lens/LED color code in place of ② in the Part No. A: amber G: green PW: pure white R: red S: blue Y: yellow	Specify an operating voltage code in place of ③ in the Part No. 2: 6V AC/DC 3: 12V AC/DC 4: 24V AC/DC

- Every illuminated pushbutton contains an LED lamp (LSTD) of the specified color and voltage. A pure white LED lamp is used for yellow illumination.
- For replacement LED lamps, see **B-064**.

APEM

Switches & Pilot Lights

Control Boxes

Emergency Stop Switches

Enabling Switches

Safety Products

Explosion Proof

Terminal Blocks

Relays & Sockets

Circuit Protectors

Power Supplies

LED Illumination

Controllers

Operator Interfaces

Sensors

AUTO-ID

Flush Silhouette

ø16

ø22

ø30

Miniature

Pilot Lights

CW

LW-F

LB

LBW

UP

Flush Bezel



## Round / Square Illuminated Pushbuttons with Black Plastic Bezel

Package Quantity: 1

Shape	Lamp	Operation	Contact Material	Contact	Part No.		
					Solder/Tab Terminal	PC Board Terminal	Screw Terminal
Round Flush with Black Plastic Bezel LW6L-M1 LW6L-A1 	LED	Momentary	Gold	SPDT	LW6L-M1C1③②	LW6L-M1C1③V②	—
				DPDT	LW6L-M1C2③②	LW6L-M1C2③V②	LW6L-M1C2③M②
				3PDT	LW6L-M1C3③②	LW6L-M1C3③V②	—
			Silver	SPDT	LW6L-M1C5③②	—	—
				DPDT	LW6L-M1C6③②	—	LW6L-M1C6③M②
				3PDT	LW6L-M1C7③②	—	—
		Maintained	Gold	SPDT	LW6L-A1C1③②	LW6L-A1C1③V②	—
				DPDT	LW6L-A1C2③②	LW6L-A1C2③V②	LW6L-A1C2③M②
				3PDT	LW6L-A1C3③②	LW6L-A1C3③V②	—
			Silver	SPDT	LW6L-A1C5③②	—	—
				DPDT	LW6L-A1C6③②	—	LW6L-A1C6③M②
				3PDT	LW6L-A1C7③②	—	—
Round Extended with Black Plastic Bezel LW6L-M2 LW6L-A2 	LED	Momentary	Gold	SPDT	LW6L-M2C1③②	LW6L-M2C1③V②	—
				DPDT	LW6L-M2C2③②	LW6L-M2C2③V②	LW6L-M2C2③M②
				3PDT	LW6L-M2C3③②	LW6L-M2C3③V②	—
			Silver	SPDT	LW6L-M2C5③②	—	—
				DPDT	LW6L-M2C6③②	—	LW6L-M2C6③M②
				3PDT	LW6L-M2C7③②	—	—
		Maintained	Gold	SPDT	LW6L-A2C1③②	LW6L-A2C1③V②	—
				DPDT	LW6L-A2C2③②	LW6L-A2C2③V②	LW6L-A2C2③M②
				3PDT	LW6L-A2C3③②	LW6L-A2C3③V②	—
			Silver	SPDT	LW6L-A2C5③②	—	—
				DPDT	LW6L-A2C6③②	—	LW6L-A2C6③M②
				3PDT	LW6L-A2C7③②	—	—
Square Flush with Black Plastic Bezel LW7L-M1 LW7L-A1 	LED	Momentary	Gold	SPDT	LW7L-M1C1③②	LW7L-M1C1③V②	—
				DPDT	LW7L-M1C2③②	LW7L-M1C2③V②	LW7L-M1C2③M②
				3PDT	LW7L-M1C3③②	LW7L-M1C3③V②	—
			Silver	SPDT	LW7L-M1C5③②	—	—
				DPDT	LW7L-M1C6③②	—	LW7L-M1C6③M②
				3PDT	LW7L-M1C7③②	—	—
		Maintained	Gold	SPDT	LW7L-A1C1③②	LW7L-A1C1③V②	—
				DPDT	LW7L-A1C2③②	LW7L-A1C2③V②	LW7L-A1C2③M②
				3PDT	LW7L-A1C3③②	LW7L-A1C3③V②	—
			Silver	SPDT	LW7L-A1C5③②	—	—
				DPDT	LW7L-A1C6③②	—	LW7L-A1C6③M②
				3PDT	LW7L-A1C7③②	—	—



## Color Code and Voltage Code

② Lens/LED Color Code	③ Operating Voltage Code
Specify a Lens/LED color code in place of ② in the Part No. A: amber G: green PW: pure white R: red S: blue Y: yellow	Specify an operating voltage code in place of ③ in the Part No. 2: 6V AC/DC 3: 12V AC/DC 4: 24V AC/DC

- Every illuminated pushbutton contains an LED lamp (LSTD) of the specified color and voltage. A pure white LED lamp is used for yellow illumination.
- For replacement LED lamps, see **B-064**.

Round / Square Illuminated Pushbuttons with Black Plastic Bezel

Package Quantity: 1

Shape	Lamp	Operation	Contact Material	Contact	Part No.	
					Solder/Tab Terminal	Screw Terminal
Round Flush Guard Type with Black Plastic Bezel LW6GL-M1 LW6GL-A1 	LED	Momentary	Gold	SPDT	LW6GL-M1C1③②	—
				DPDT	LW6GL-M1C2③②	LW6GL-M1C2③M②
				3PDT	LW6GL-M1C3③②	—
			Silver	SPDT	LW6GL-M1C5③②	—
				DPDT	LW6GL-M1C6③②	LW6GL-M1C6③M②
				3PDT	LW6GL-M1C7③②	—
		Maintained	Gold	SPDT	LW6GL-A1C1③②	—
				DPDT	LW6GL-A1C2③②	LW6GL-A1C2③M②
				3PDT	LW6GL-A1C3③②	—
			Silver	SPDT	LW6GL-A1C5③②	—
				DPDT	LW6GL-A1C6③②	LW6GL-A1C6③M②
				3PDT	LW6GL-A1C7③②	—
Square Flush Guard with Black Plastic Bezel LW7GL-M1 LW7GL-A1 	LED	Momentary	Gold	SPDT	LW7GL-M1C1③②	—
				DPDT	LW7GL-M1C2③②	LW7GL-M1C2③M②
				3PDT	LW7GL-M1C3③②	—
			Silver	SPDT	LW7GL-M1C5③②	—
				DPDT	LW7GL-M1C6③②	LW7GL-M1C6③M②
				3PDT	LW7GL-M1C7③②	—
		Maintained	Gold	SPDT	LW7GL-A1C1③②	—
				DPDT	LW7GL-A1C2③②	LW7GL-A1C2③M②
				3PDT	LW7GL-A1C3③②	—
			Silver	SPDT	LW7GL-A1C5③②	—
				DPDT	LW7GL-A1C6③②	LW7GL-A1C6③M②
				3PDT	LW7GL-A1C7③②	—

Color Code and Voltage Code

② Lens/LED Color Code	③ Operating Voltage Code
Specify a Lens/LED color code in place of ② in the Part No. A: amber G: green PW: pure white S: blue Y: yellow	Specify an operating voltage code in place of ③ in the Part No. 2: 6V AC/DC 3: 12V AC/DC 4: 24V AC/DC

- Every illuminated pushbutton contains an LED lamp (LSTD) of the specified color and voltage. A pure white LED lamp is used for yellow illumination.
- For replacement LED lamps, see **B-064**.

APEM

Switches & Pilot Lights

Control Boxes

Emergency Stop Switches

Enabling Switches

Safety Products

Explosion Proof

Terminal Blocks

Relays & Sockets

Circuit Protectors

Power Supplies

LED Illumination

Controllers

Operator Interfaces

Sensors

AUTO-ID

Flush Silhouette

ø16

ø22

ø30

Miniature

Pilot Lights

CW

LW-F

LB

LBW

UP

Flush Bezel

Dimensions

All dimensions in mm.

Round/Square

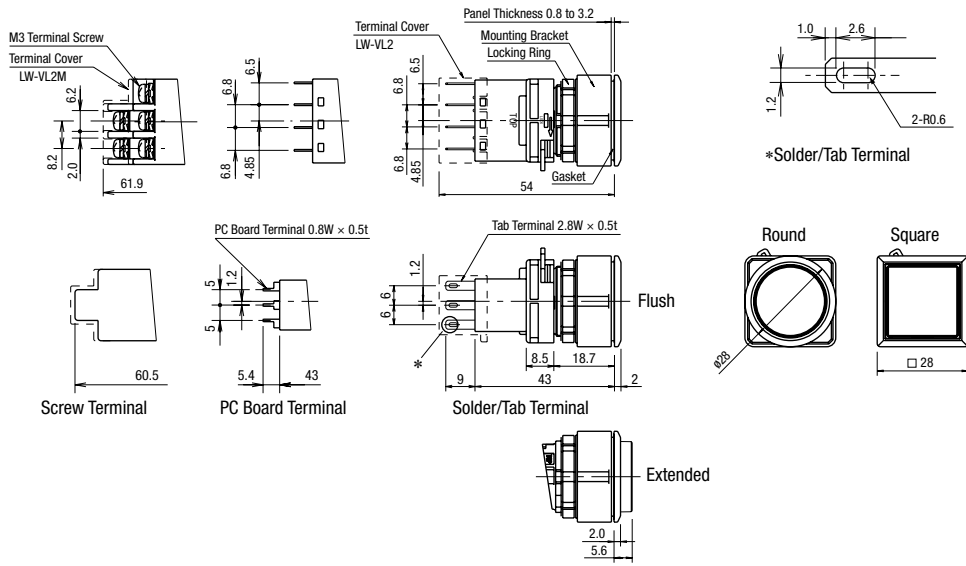

Round with Switch Guard

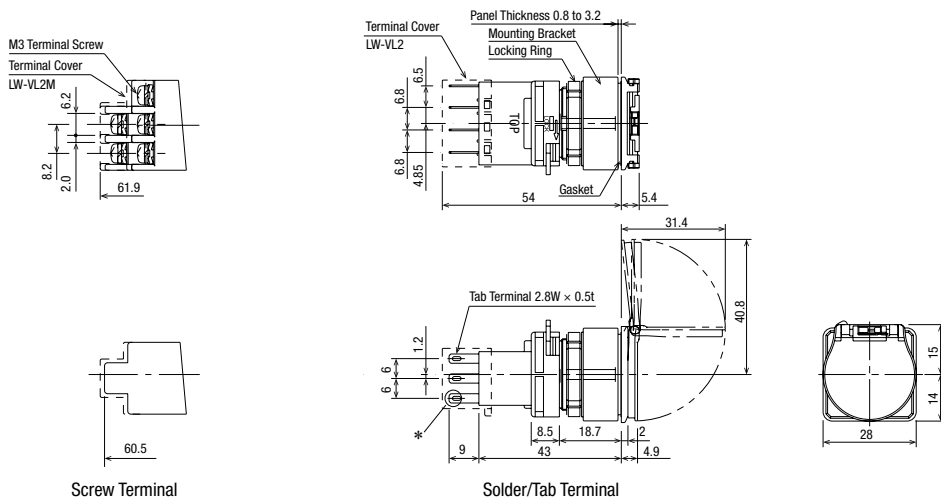

Square with Switch Guard

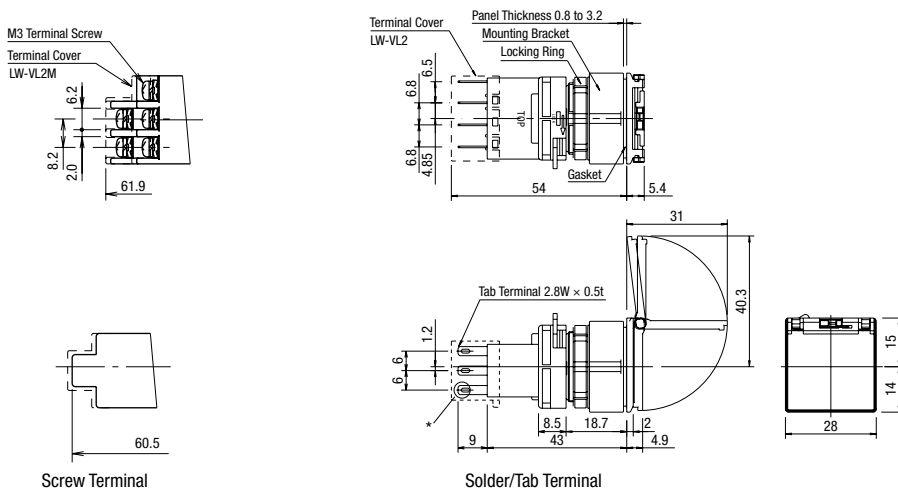

APEM

Switches & Pilot Lights

Control Boxes

Emergency Stop Switches

Enabling Switches

Safety Products

Explosion Proof

Terminal Blocks

Relays & Sockets

Circuit Protectors

Power Supplies

LED Illumination

Controllers

Operator Interfaces

Sensors

AUTO-ID

Flush Silhouette

Ø16

Ø22

Ø30

Miniature

Pilot Lights

CW

LW-F

LB

LBW

UP

Flush Bezel

- APEM
- Switches & Pilot Lights
- Control Boxes
- Emergency Stop Switches
- Enabling Switches
- Safety Products
- Explosion Proof
- Terminal Blocks
- Relays & Sockets
- Circuit Protectors
- Power Supplies
- LED Illumination
- Controllers
- Operator Interfaces
- Sensors
- AUTO-ID

- Flush Silhouette
- ø16
- ø22
- ø30
- Miniature
- Pilot Lights

- CW
- LW-F
- LB
- LBW
- UP
- Flush Bezel

Dimensions

All dimensions in mm.

Bottom View

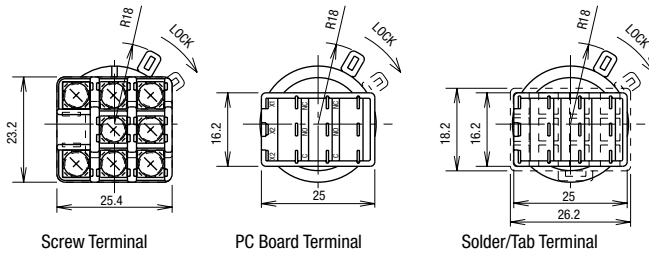

Terminal Arrangement (Bottom View)

Solder/Tab Terminal/PC Board Terminal

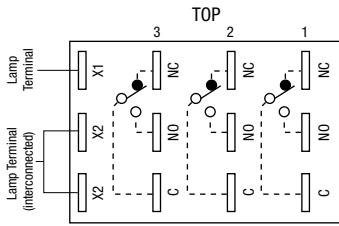

Screw Terminal

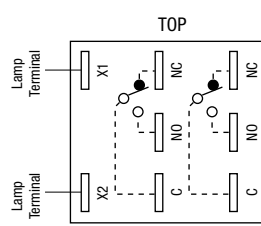

Note: SPDT has C, NO, and NC only in the center. DPDT has C, NO, and NC only on the right and left. Lamp terminals do not have any polarity.

PC Board Drilling Layout (Bottom View)

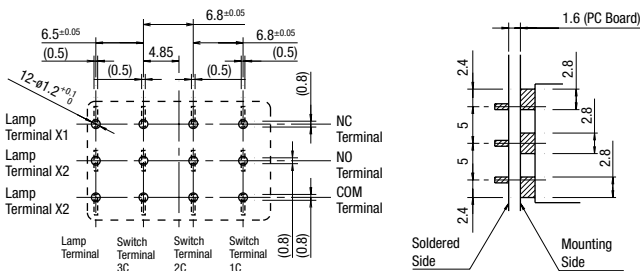

Note the pattern of the PC board as the terminals on the mounting surface are 2.8 mm wide.

Applicable Crimping Terminal

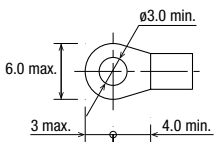



## Round / Square Pilot Lights with Metal Bezel and Black Plastic Bezel

Package Quantity: 1

Shape	Lamp	Input Type	Part No.			② Illumination Color Code
			Solder/Tab Terminal (Unibody)	PC Board Terminal (w/Removable Contact Block)	Screw Terminal (Unibody)	
Round Flush with Metal Bezel LW6MP-1 	LED	6V AC/DC ±10%	LW6MP-12②	LW6MP-1C02V②	LW6MP-12M②	Specify a illumination color code in place of ② in the Part No.  A: amber G: green PW: pure white R: red S: blue Y: yellow
		12V AC/DC ±10%	LW6MP-13②	LW6MP-1C03V②	LW6MP-13M②	
		24V AC/DC ±10%	LW6MP-14②	LW6MP-1C04V②	LW6MP-14M②	
Round Extended with Metal Bezel LW6MP-2 	LED	6V AC/DC ±10%	LW6MP-22②	LW6MP-2C02V②	LW6MP-22M②	
		12V AC/DC ±10%	LW6MP-23②	LW6MP-2C03V②	LW6MP-23M②	
		24V AC/DC ±10%	LW6MP-24②	LW6MP-2C04V②	LW6MP-24M②	
Round Flush with Black Plastic Bezel LW6P-1 	LED	6V AC/DC ±10%	LW6P-12②	LW6P-1C02V②	LW6P-12M②	
		12V AC/DC ±10%	LW6P-13②	LW6P-1C03V②	LW6P-13M②	
		24V AC/DC ±10%	LW6P-14②	LW6P-1C04V②	LW6P-14M②	
Round Extended with Black Plastic Bezel LW6P-2 	LED	6V AC/DC ±10%	LW6P-22②	LW6P-2C02V②	LW6P-22M②	
		12V AC/DC ±10%	LW6P-23②	LW6P-2C03V②	LW6P-23M②	
		24V AC/DC ±10%	LW6P-24②	LW6P-2C04V②	LW6P-24M②	
Square Flush with Black Plastic Bezel LW7P-1 	LED	6V AC/DC ±10%	LW7P-12②	LW7P-1C02V②	LW7P-12M②	
		12V AC/DC ±10%	LW7P-13②	LW7P-1C03V②	LW7P-13M②	
		24V AC/DC ±10%	LW7P-14②	LW7P-1C04V②	LW7P-14M②	
Square Extended with Black Plastic Bezel LW7P-2 	LED	6V AC/DC ±10%	LW7P-22②	LW7P-2C02V②	LW7P-22M②	
		12V AC/DC ±10%	LW7P-23②	LW7P-2C03V②	LW7P-23M②	
		24V AC/DC ±10%	LW7P-24②	—	LW7P-24M②	

- Every pilot light contains an LED lamp (LSTD) of the specified color and voltage. A pure white LED lamp is used for yellow illumination.
- For replacement LED lamps, see **B-064**.

APEM

Switches & Pilot Lights

Control Boxes

Emergency Stop Switches

Enabling Switches

Safety Products

Explosion Proof

Terminal Blocks

Relays & Sockets

Circuit Protectors

Power Supplies

LED Illumination

Controllers

Operator Interfaces

Sensors

AUTO-ID

Flush Silhouette

ø16

ø22

ø30

Miniature

Pilot Lights

CW

LW-F

LB

LBW

UP

Flush Bezel

Dimensions

All dimensions in mm.

Unibody

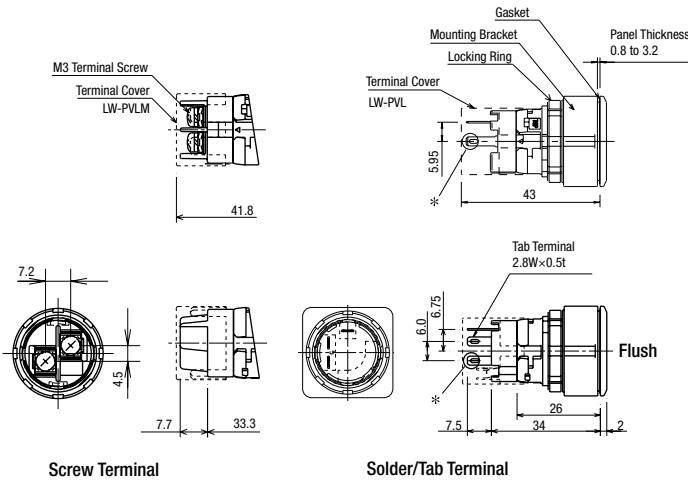

w/Removable Contact Block

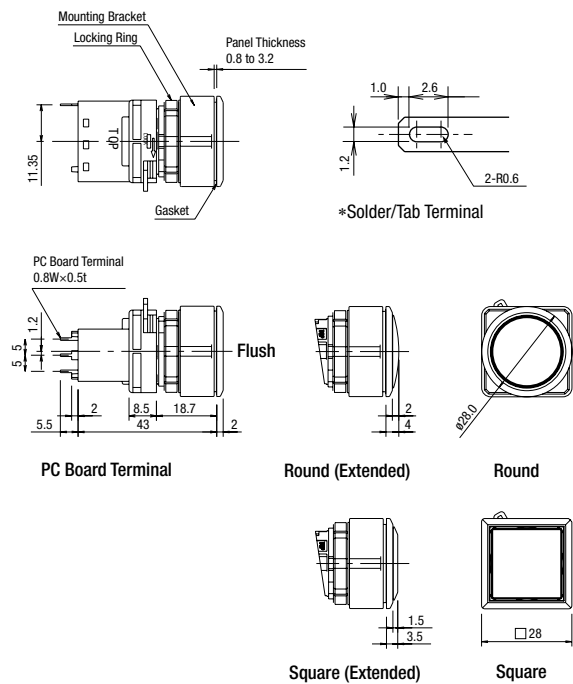

Terminal Arrangement (Bottom View)

Unibody

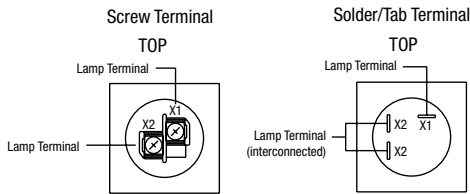

Lamp terminals do not have any polarity.

w/Removable Contact Block

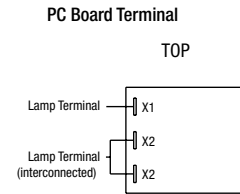

Lamp terminals do not have any polarity.

PC Board Drilling Layout (Bottom View)

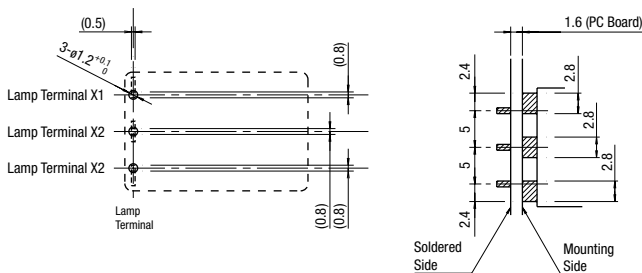

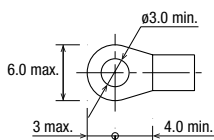

Note the pattern of the PC board as the terminals on the mounting surface are 2.8 mm wide.

Applicable Crimping Terminal



## Round Pushbuttons with Metal Bezel

Package Quantity: 1

Shape	Operation	Contact Material	Contact	Part No.			① Button Color Code
				Solder/Tab Terminal	PC Board Terminal	Screw Terminal	
Round Flush with Metal Bezel LW6MB-M1 LW6MB-A1 	Momentary	Gold	SPDT	LW6MB-M1C1①	LW6MB-M1C1V①	—	Specify a button color code in place of ① in the Part No.  LA: amber LB: black LG: green LR: red LS: blue LW: white LY: yellow
			DPDT	LW6MB-M1C2①	LW6MB-M1C2V①	LW6MB-M1C2M①	
			3PDT	LW6MB-M1C3①	LW6MB-M1C3V①	—	
		Silver	SPDT	LW6MB-M1C5①	—	—	
			DPDT	LW6MB-M1C6①	—	LW6MB-M1C6M①	
			3PDT	LW6MB-M1C7①	—	—	
	Maintained	Gold	SPDT	LW6MB-A1C1①	LW6MB-A1C1V①	—	
			DPDT	LW6MB-A1C2①	LW6MB-A1C2V①	LW6MB-A1C2M①	
			3PDT	LW6MB-A1C3①	LW6MB-A1C3V①	—	
		Silver	SPDT	LW6MB-A1C5①	—	—	
			DPDT	LW6MB-A1C6①	—	LW6MB-A1C6M①	
			3PDT	LW6MB-A1C7①	—	—	
Round Extended with Metal Bezel LW6MB-M2 LW6MB-A2 	Momentary	Gold	SPDT	LW6MB-M2C1①	LW6MB-M2C1V①	—	Specify a button color code in place of ① in the Part No.  LA: amber LB: black LG: green LR: red LS: blue LW: white LY: yellow
			DPDT	LW6MB-M2C2①	LW6MB-M2C2V①	LW6MB-M2C2M①	
			3PDT	LW6MB-M2C3①	LW6MB-M2C3V①	—	
		Silver	SPDT	LW6MB-M2C5①	—	—	
			DPDT	LW6MB-M2C6①	—	LW6MB-M2C6M①	
			3PDT	LW6MB-M2C7①	—	—	
	Maintained	Gold	SPDT	LW6MB-A2C1①	LW6MB-A2C1V①	—	
			DPDT	LW6MB-A2C2①	LW6MB-A2C2V①	LW6MB-A2C2M①	
			3PDT	LW6MB-A2C3①	LW6MB-A2C3V①	—	
		Silver	SPDT	LW6MB-A2C5①	—	—	
			DPDT	LW6MB-A2C6①	—	LW6MB-A2C6M①	
			3PDT	LW6MB-A2C7①	—	—	

- Lens style buttons are used for illuminated pushbuttons.
- For details on marking plate and film, see **B-066**.

## Flush Silhouette

ø16

ø22

ø30

Miniature

Pilot Lights

CW

LW-F

LB



LBW

UP

Flush Bezel

Round / Square Pushbuttons with Black Plastic Bezel

Package Quantity: 1

Shape	Operation	Contact Material	Contact	Part No.			① Button Color Code
				Solder/Tab Terminal	PC Board Terminal	Screw Terminal	
Round Flush with Black Plastic Bezel LW6B-M1 LW6B-A1 	Momentary	Gold	SPDT	LW6B-M1C1①	LW6B-M1C1V①	—	Specify a button color code in place of ① in the Part No.  LA: amber LB: black LG: green LR: red LS: blue LW: white LY: yellow
			DPDT	LW6B-M1C2①	LW6B-M1C2V①	LW6B-M1C2M①	
			3PDT	LW6B-M1C3①	LW6B-M1C3V①	—	
		Silver	SPDT	LW6B-M1C5①	—	—	
			DPDT	LW6B-M1C6①	—	LW6B-M1C6M①	
			3PDT	LW6B-M1C7①	—	—	
	Maintained	Gold	SPDT	LW6B-A1C1①	LW6B-A1C1V①	—	
			DPDT	LW6B-A1C2①	LW6B-A1C2V①	LW6B-A1C2M①	
			3PDT	LW6B-A1C3①	LW6B-A1C3V①	—	
		Silver	SPDT	LW6B-A1C5①	—	—	
			DPDT	LW6B-A1C6①	—	LW6B-A1C6M①	
			3PDT	LW6B-A1C7①	—	—	
Round Extended with Black Plastic Bezel LW6B-M2 LW6B-A2 	Momentary	Gold	SPDT	LW6B-M2C1①	LW6B-M2C1V①	—	
			DPDT	LW6B-M2C2①	LW6B-M2C2V①	LW6B-M2C2M①	
			3PDT	LW6B-M2C3①	LW6B-M2C3V①	—	
		Silver	SPDT	LW6B-M2C5①	—	—	
			DPDT	LW6B-M2C6①	—	LW6B-M2C6M①	
			3PDT	LW6B-M2C7①	—	—	
	Maintained	Gold	SPDT	LW6B-A2C1①	LW6B-A2C1V①	—	
			DPDT	LW6B-A2C2①	LW6B-A2C2V①	LW6B-A2C2M①	
			3PDT	LW6B-A2C3①	LW6B-A2C3V①	—	
		Silver	SPDT	LW6B-A2C5①	—	—	
			DPDT	LW6B-A2C6①	—	LW6B-A2C6M①	
			3PDT	LW6B-A2C7①	—	—	
Square Flush with Black Plastic Bezel LW7B-M1 LW7B-A1 	Momentary	Gold	SPDT	LW7B-M1C1①	LW7B-M1C1V①	—	
			DPDT	LW7B-M1C2①	LW7B-M1C2V①	LW7B-M1C2M①	
			3PDT	LW7B-M1C3①	LW7B-M1C3V①	—	
		Silver	SPDT	LW7B-M1C5①	—	—	
			DPDT	LW7B-M1C6①	—	LW7B-M1C6M①	
			3PDT	LW7B-M1C7①	—	—	
	Maintained	Gold	SPDT	LW7B-A1C1①	LW7B-A1C1V①	—	
			DPDT	LW7B-A1C2①	LW7B-A1C2V①	LW7B-A1C2M①	
			3PDT	LW7B-A1C3①	LW7B-A1C3V①	—	
		Silver	SPDT	LW7B-A1C5①	—	—	
			DPDT	LW7B-A1C6①	—	LW7B-A1C6M①	
			3PDT	LW7B-A1C7①	—	—	

- Lens style buttons are used for illuminated pushbuttons.
- For details on marking plate and film, see B-066.

APEM

Switches & Pilot Lights

Control Boxes

Emergency Stop Switches

Enabling Switches

Safety Products

Explosion Proof

Terminal Blocks

Relays & Sockets

Circuit Protectors

Power Supplies

LED Illumination

Controllers

Operator Interfaces

Sensors

AUTO-ID

Flush Silhouette

ø16

ø22

ø30

Miniature

Pilot Lights

CW

LW-F

LB

LBW



UP

Flush Bezel



## Round / Square Pushbuttons with Black Plastic Bezel

Package Quantity: 1

Shape	Operation	Contact Material	Contact	Part No.		① Button Color Code
				Solder/Tab Terminal	Screw Terminal	
Round Flush Guard Type with Black Plastic Bezel LW6GB-M1 LW6GB-A1 	Momentary	Gold	SPDT	LW6GB-M1C1①	—	Specify a button color code in place of ① in the Part No.  LA: amber LB: black LG: green LR: red LS: blue LW: white LY: yellow
			DPDT	LW6GB-M1C2①	LW6GB-M1C2M①	
			3PDT	LW6GB-M1C3①	—	
		Silver	SPDT	LW6GB-M1C5①	—	
			DPDT	LW6GB-M1C6①	LW6GB-M1C6M①	
			3PDT	LW6GB-M1C7①	—	
	Maintained	Gold	SPDT	LW6GB-A1C1①	—	
			DPDT	LW6GB-A1C2①	LW6GB-A1C2M①	
			3PDT	LW6GB-A1C3①	—	
		Silver	SPDT	LW6GB-A1C5①	—	
			DPDT	LW6GB-A1C6①	LW6GB-A1C6M①	
			3PDT	LW6GB-A1C7①	—	
Square Flush Guard Type with Black Plastic Bezel LW7GB-M1 LW7GB-A1 	Momentary	Gold	SPDT	LW7GB-M1C1①	—	
			DPDT	LW7GB-M1C2①	LW7GB-M1C2M①	
			3PDT	LW7GB-M1C3①	—	
		Silver	SPDT	LW7GB-M1C5①	—	
			DPDT	LW7GB-M1C6①	LW7GB-M1C6M①	
			3PDT	LW7GB-M1C7①	—	
	Maintained	Gold	SPDT	LW7GB-A1C1①	—	
			DPDT	LW7GB-A1C2①	LW7GB-A1C2M①	
			3PDT	LW7GB-A1C3①	—	
		Silver	SPDT	LW7GB-A1C5①	—	
			DPDT	LW7GB-A1C6①	LW7GB-A1C6M①	
			3PDT	LW7GB-A1C7①	—	

- Lenses for illuminated pushbuttons are used for flush silhouette pushbuttons.
- For details on marking plate and film, see **B-066**.

## Flush Silhouette

ø16

ø22

ø30

Miniature

Pilot Lights

CW

LW-F

LB

LBW

UP

Flush Bezel

Dimensions

All dimensions in mm.

Round/Square

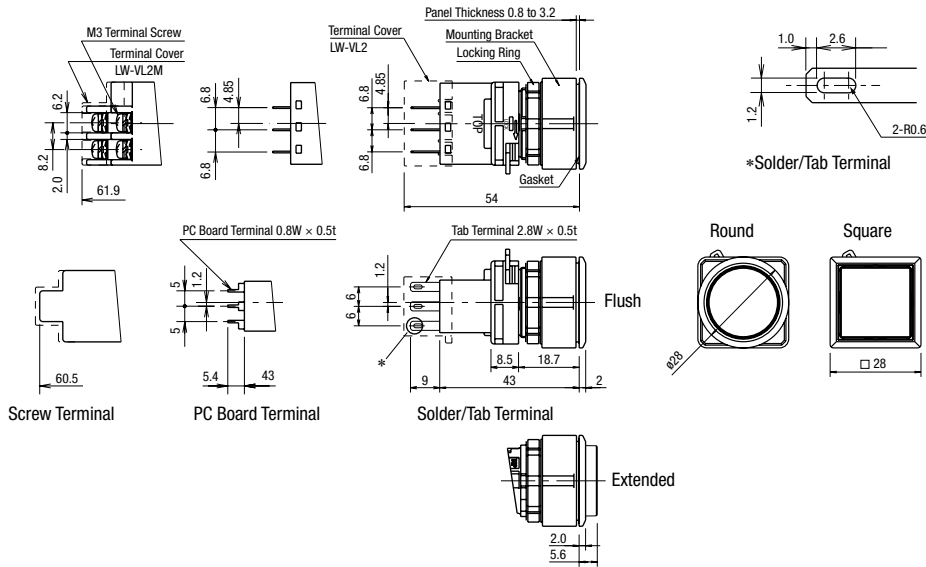

Round Flush Guard

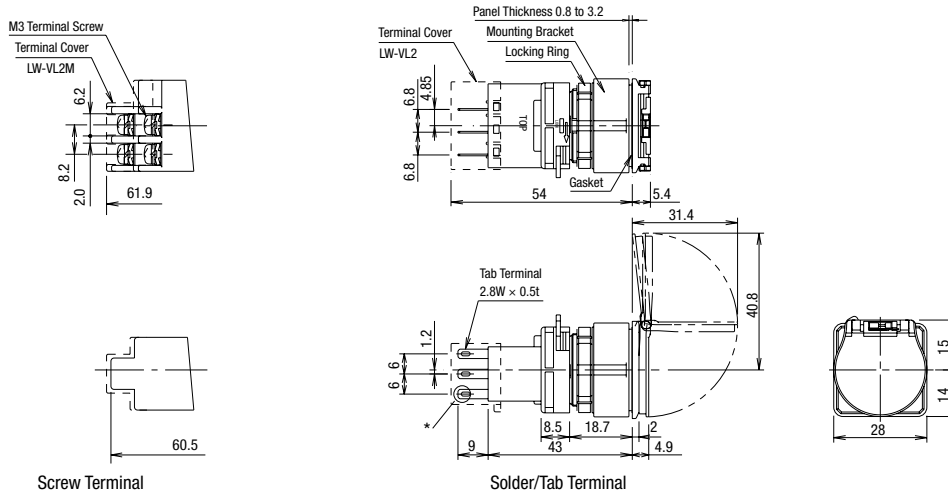

Square Flush Guard

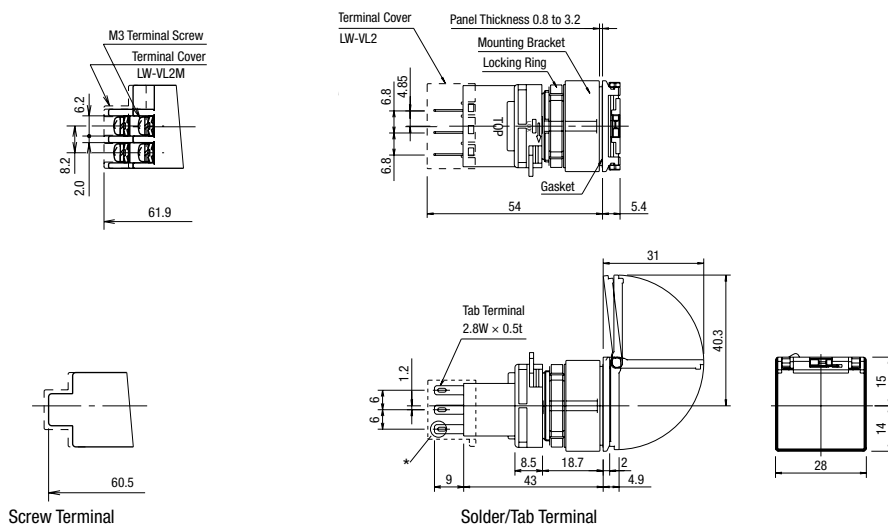

- APEM
- Switches & Pilot Lights
- Control Boxes
- Emergency Stop Switches
- Enabling Switches
- Safety Products
- Explosion Proof
- Terminal Blocks
- Relays & Sockets
- Circuit Protectors
- Power Supplies
- LED Illumination
- Controllers
- Operator Interfaces
- Sensors
- AUTO-ID

- Flush Silhouette
- ø16
- ø22
- ø30
- Miniature
- Pilot Lights

- CW
- LW-F
- LB
- LBW
- UP
- Flush Bezel

# Flush Silhouette Switches LW Series

## Dimensions

All dimensions in mm.

### Bottom View

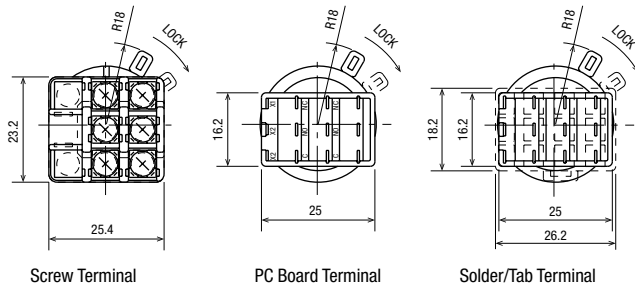

Note: Dotted lines are dimensions for terminal cover (LW-VL2).

### Terminal Arrangement (Bottom View)

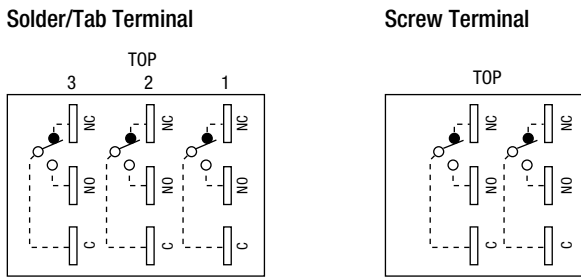

Note: SPDT has C, NO, and NC only in the center. DPDT has C, NO, and NC only on the right and left. Screw terminal is only available in DPDT configuration.

### PC Board Drilling Layout (Bottom View)

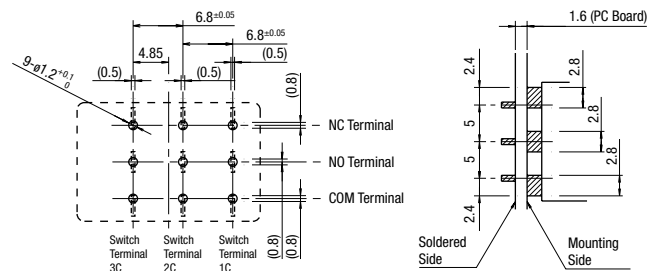

Note the pattern of the PC board as the terminals on the mounting surface are 2.8 mm wide.

### Applicable Crimping Terminal

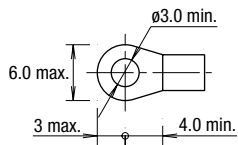





- APEM
- Switches & Pilot Lights
- Control Boxes
- Emergency Stop Switches
- Enabling Switches
- Safety Products
- Explosion Proof
- Terminal Blocks
- Relays & Sockets
- Circuit Protectors
- Power Supplies
- LED Illumination
- Controllers
- Operator Interfaces
- Sensors
- AUTO-ID

- Flush Silhouette
- ø16
- ø22
- ø30
- Miniature
- Pilot Lights



- CW
- LW-F
- LB
- LBW
- UP
- Flush Bezel

Selector Switches with Round Metal Bezel

Package Quantity: 1

Shape	Operation	Position	Contact Material	Contact	Part No.		
					Solder/Tab Terminal	PC Board Terminal	Screw Terminal
Round Metal Bezel LW6MS (Knob Operator)  	90° 2-position Maintained		Gold	SPDT	LW6MS-2C1	LW6MS-2C1V	—
				DPDT	LW6MS-2C2	LW6MS-2C2V	LW6MS-2C2M
				3PDT	LW6MS-2C3	LW6MS-2C3V	—
			Silver	SPDT	LW6MS-2C5	—	—
				DPDT	LW6MS-2C6	—	LW6MS-2C6M
				3PDT	LW6MS-2C7	—	—
	90° 3-position Spring Return from Right		Gold	SPDT	LW6MS-21C1	LW6MS-21C1V	—
				DPDT	LW6MS-21C2	LW6MS-21C2V	LW6MS-21C2M
				3PDT	LW6MS-21C3	LW6MS-21C3V	—
			Silver	SPDT	LW6MS-21C5	—	—
				DPDT	LW6MS-21C6	—	LW6MS-21C6M
				3PDT	LW6MS-21C7	—	—
	45° 3-position Maintained		Gold	DPDT	LW6MS-3C2	LW6MS-3C2V	LW6MS-3C2M
				3PDT	LW6MS-3C3	LW6MS-3C3V	—
			Silver	DPDT	LW6MS-3C6	—	LW6MS-3C6M
				3PDT	LW6MS-3C7	—	—
Gold			DPDT	LW6MS-33C2	LW6MS-33C2V	LW6MS-33C2M	
			3PDT	LW6MS-33C3	LW6MS-33C3V	—	
Silver	DPDT	LW6MS-33C6	—	LW6MS-33C6M			
	3PDT	LW6MS-33C7	—	—			

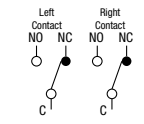
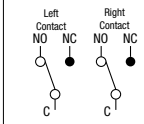
Contact Operation

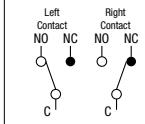
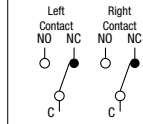
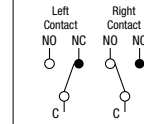
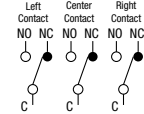
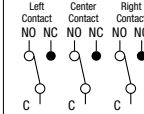
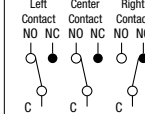
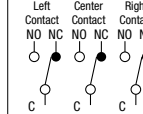
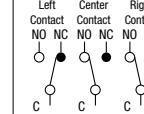
Operation	Contact	Operator Position and Contact Position (Top View)		Operation	Contact	Operator Position and Contact Position (Top View)		
		↙ Left	↘ Right			↙ Left	↑ Center	↘ Right
 90° 2-Position	SPDT DPDT			 45° 3-Position	DPDT			
	3PDT				3PDT			





• SPDT has C, NO, and NC only in the center of the terminal.

- APEM
- Switches & Pilot Lights
- Control Boxes
- Emergency Stop Switches
- Enabling Switches
- Safety Products
- Explosion Proof
- Terminal Blocks
- Relays & Sockets
- Circuit Protectors
- Power Supplies
- LED Illumination
- Controllers
- Operator Interfaces
- Sensors
- AUTO-ID
- Flush Silhouette
- ø16
- ø22
- ø30
- Miniature
- Pilot Lights
- CW
- LW-F
- LB
- LBW
- UP
- Flush Bezel





## Selector Switches with Round Metal Bezel

Package Quantity: 1

Shape	Operation	Position	Contact Material	Contact	Part No.		
					Solder/Tab Terminal	PC Board Terminal	Screw Terminal
Round Metal Bezel LW6MS-*L (Lever Operator) 	90° 2-position Maintained		Gold	SPDT	LW6MS-2LC1	LW6MS-2LC1V	—
				DPDT	LW6MS-2LC2	LW6MS-2LC2V	LW6MS-2LC2M
				3PDT	LW6MS-2LC3	LW6MS-2LC3V	—
			Silver	SPDT	LW6MS-2LC5	—	—
				DPDT	LW6MS-2LC6	—	LW6MS-2LC6M
				3PDT	LW6MS-2LC7	—	—
	90° 2-position Spring Return from Right		Gold	SPDT	LW6MS-21LC1	LW6MS-21LC1V	—
				DPDT	LW6MS-21LC2	LW6MS-21LC2V	LW6MS-21LC2M
				3PDT	LW6MS-21LC3	LW6MS-21LC3V	—
			Silver	SPDT	LW6MS-21LC5	—	—
				DPDT	LW6MS-21LC6	—	LW6MS-21LC6M
				3PDT	LW6MS-21LC7	—	—
	45° 3-position Maintained		Gold	DPDT	LW6MS-3LC2	LW6MS-3LC2V	LW6MS-3LC2M
				3PDT	LW6MS-3LC3	LW6MS-3LC3V	—
				Silver	DPDT	LW6MS-3LC6	—
			3PDT		LW6MS-3LC7	—	—
					—	—	—
			45° 3-position Spring Return Two-way		Gold	DPDT	LW6MS-33LC2
3PDT	LW6MS-33LC3	LW6MS-33LC3V				—	
Silver	DPDT	LW6MS-33LC6				—	LW6MS-33LC6M
	3PDT	LW6MS-33LC7			—	—	
		—			—	—	

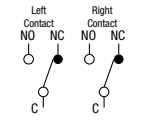
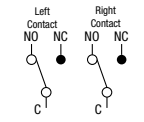

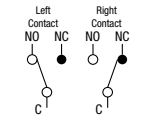
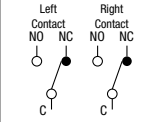
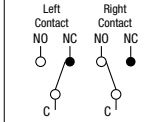
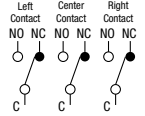
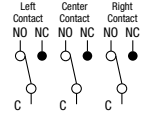
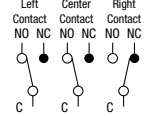
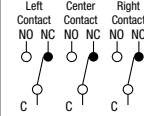
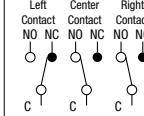

## Contact Operation

Operation	Contact	Operator Position and Contact Position (Top View)		Operation	Contact	Operator Position and Contact Position (Top View)		
		Left	Right			Left	Center	Right
 90° 2-Position	SPDT DPDT			 45° 3-Position	DPDT			
	3PDT				3PDT			



• SPDT has C, NO, and NC only in the center of the terminal.

Selector Switches with Round Black Plastic Bezel

Package Quantity: 1

Shape	Operation	Position	Contact Material	Contact	Part No.		
					Solder/Tab Terminal	PC Board Terminal	Screw Terminal
Round Black Plastic Bezel LW6S (Knob Operator)  	90° 2-position Maintained		Gold	SPDT	LW6S-2C1	LW6S-2C1V	—
				DPDT	LW6S-2C2	LW6S-2C2V	LW6S-2C2M
				3PDT	LW6S-2C3	LW6S-2C3V	—
			Silver	SPDT	LW6S-2C5	—	—
				DPDT	LW6S-2C6	—	LW6S-2C6M
				3PDT	LW6S-2C7	—	—
	90° 2-position Spring Return from Right		Gold	SPDT	LW6S-21C1	LW6S-21C1V	—
				DPDT	LW6S-21C2	LW6S-21C2V	LW6S-21C2M
				3PDT	LW6S-21C3	LW6S-21C3V	—
			Silver	SPDT	LW6S-21C5	—	—
				DPDT	LW6S-21C6	—	LW6S-21C6M
				3PDT	LW6S-21C7	—	—
	45° 3-position Maintained		Gold	DPDT	LW6S-3C2	LW6S-3C2V	LW6S-3C2M
				3PDT	LW6S-3C3	LW6S-3C3V	—
			Silver	DPDT	LW6S-3C6	—	LW6S-3C6M
				3PDT	LW6S-3C7	—	—
45° 3-position Spring Return Two-way		Gold	DPDT	LW6S-33C2	LW6S-33C2V	LW6S-33C2M	
			3PDT	LW6S-33C3	LW6S-33C3V	—	
		Silver	DPDT	LW6S-33C6	—	LW6S-33C6M	
			3PDT	LW6S-33C7	—	—	

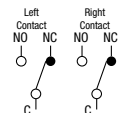
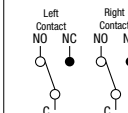
Contact Operation

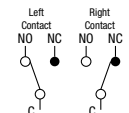
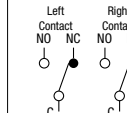
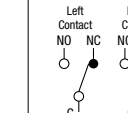
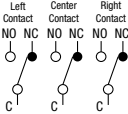
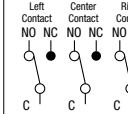
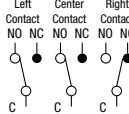
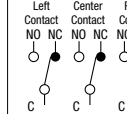
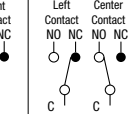
Operation	Contact	Operator Position and Contact Position (Top View)		Operation	Contact	Operator Position and Contact Position (Top View)		
		↙ Left	↘ Right			↙ Left	↑ Center	↘ Right
 90° 2-Position	SPDT DPDT			 45° 3-Position	DPDT			
	3PDT				3PDT			

• SPDT has C, NO, and NC only in the center of the terminal.

APEM

Switches & Pilot Lights

Control Boxes

Emergency Stop Switches

Enabling Switches

Safety Products

Explosion Proof

Terminal Blocks

Relays & Sockets

Circuit Protectors

Power Supplies

LED Illumination

Controllers

Operator Interfaces

Sensors

AUTO-ID

Flush Silhouette

ø16

ø22

ø30

Miniature

Pilot Lights

CW

LW-F

LB

LBW

UP





Flush Bezel





Download catalogs and CAD from <http://eu.idec.com/downloads>

## Selector Switches with Round Black Plastic Bezel

Package Quantity: 1

Shape	Operation	Position	Contact Material	Contact	Part No.				
					Solder/Tab Terminal	PC Board Terminal	Screw Terminal		
Round Black Plastic Bezel LW6S-*L (Lever Operator) 	90° 2-position Maintained		Gold	SPDT	LW6S-2LC1	LW6S-2LC1V	—		
				DPDT	LW6S-2LC2	LW6S-2LC2V	LW6S-2LC2M		
				3PDT	LW6S-2LC3	LW6S-2LC3V	—		
			Silver	SPDT	LW6S-2LC5	—	—		
				DPDT	LW6S-2LC6	—	LW6S-2LC6M		
				3PDT	LW6S-2LC7	—	—		
	90° 2-position Spring Return from Right		Gold	SPDT	LW6S-21LC1	LW6S-21LC1V	—		
				DPDT	LW6S-21LC2	LW6S-21LC2V	LW6S-21LC2M		
				3PDT	LW6S-21LC3	LW6S-21LC3V	—		
			Silver	SPDT	LW6S-21LC5	—	—		
				DPDT	LW6S-21LC6	—	LW6S-21LC6M		
				3PDT	LW6S-21LC7	—	—		
	45° 3-position Maintained		Gold	DPDT	LW6S-3LC2	LW6S-3LC2V	LW6S-3LC2M		
				3PDT	LW6S-3LC3	LW6S-3LC3V	—		
				Silver	DPDT	LW6S-3LC6	—	LW6S-3LC6M	
			3PDT		LW6S-3LC7	—	—		
			45° 3-position Spring Return Two-way			Gold	DPDT	LW6S-33LC2	LW6S-33LC2V
				3PDT			LW6S-33LC3	LW6S-33LC3V	—
Silver	DPDT	LW6S-33LC6		—			LW6S-33LC6M		
	3PDT	LW6S-33LC7		—		—			

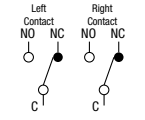
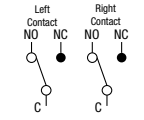

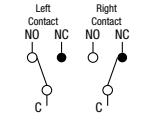
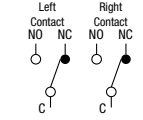
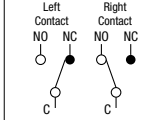
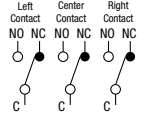
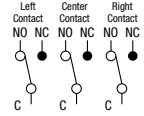
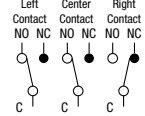
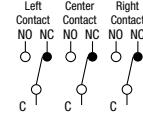
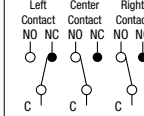

## Contact Operation

Operation	Contact	Operator Position and Contact Position (Top View)		Operation	Contact	Operator Position and Contact Position (Top View)		
		Left	Right			Left	Center	Right
 90° 2-Position	SPDT DPDT			 45° 3-Position	DPDT			
	3PDT				3PDT			



• SPDT has C, NO, and NC only in the center of the terminal.

Selector Switches with Square Black Plastic Bezel

Package Quantity: 1

Shape	Operation	Position	Contact Material	Contact	Part No.		
					Solder/Tab Terminal	PC Board Terminal	Screw Terminal
Square Black Plastic Bezel LW7S (Knob Operator) 	90° 2-position Maintained		Gold	SPDT	LW7S-2C1	LW7S-2C1V	—
				DPDT	LW7S-2C2	LW7S-2C2V	LW7S-2C2M
				3PDT	LW7S-2C3	LW7S-2C3V	—
			Silver	SPDT	LW7S-2C5	—	—
				DPDT	LW7S-2C6	—	LW7S-2C6M
				3PDT	LW7S-2C7	—	—
	90° 2-position Spring Return from Right		Gold	SPDT	LW7S-21C1	LW7S-21C1V	—
				DPDT	LW7S-21C2	LW7S-21C2V	LW7S-21C2M
				3PDT	LW7S-21C3	LW7S-21C3V	—
			Silver	SPDT	LW7S-21C5	—	—
				DPDT	LW7S-21C6	—	LW7S-21C6M
				3PDT	LW7S-21C7	—	—
	45° 3-position Maintained		Gold	DPDT	LW7S-3C2	LW7S-3C2V	LW7S-3C2M
				3PDT	LW7S-3C3	LW7S-3C3V	—
			Silver	DPDT	LW7S-3C6	—	LW7S-3C6M
				3PDT	LW7S-3C7	—	—
Gold			DPDT	LW7S-33C2	LW7S-33C2V	LW7S-33C2M	
			3PDT	LW7S-33C3	LW7S-33C3V	—	
Silver	DPDT	LW7S-33C6	—	LW7S-33C6M			
	3PDT	LW7S-33C7	—	—			

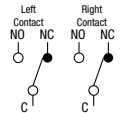
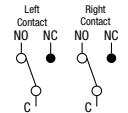
Contact Operation

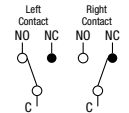
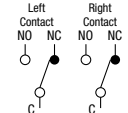
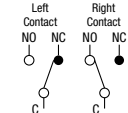
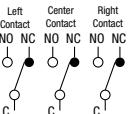
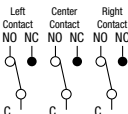
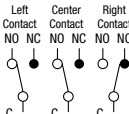
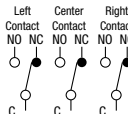
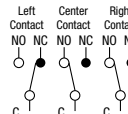
Operation	Contact	Operator Position and Contact Position (Top View)		Operation	Contact	Operator Position and Contact Position (Top View)		
		↙ Left	↘ Right			↙ Left	↑ Center	↘ Right
 90° 2-Position	SPDT DPDT			 45° 3-Position	DPDT			
	3PDT							

• SPDT has C, NO, and NC only in the center of the terminal.

APEM

Switches & Pilot Lights

Control Boxes

Emergency Stop Switches

Enabling Switches

Safety Products

Explosion Proof

Terminal Blocks

Relays & Sockets

Circuit Protectors

Power Supplies

LED Illumination

Controllers

Operator Interfaces

Sensors

AUTO-ID

Flush Silhouette

ø16

ø22

ø30

Miniature

Pilot Lights

CW

LW-F

LB





LBW

UP



Flush Bezel

## Selector Switches with Square Black Plastic Bezel

Package Quantity: 1

Shape	Operation	Position	Contact Material	Contact	Part No.					
					Solder/Tab Terminal	PC Board Terminal	Screw Terminal			
Square Black Plastic Bezel LW7S-*L (Lever Operator) 	90° 2-position Maintained		Gold	SPDT	LW7S-2LC1	LW7S-2LC1V	—			
				DPDT	LW7S-2LC2	LW7S-2LC2V	LW7S-2LC2M			
				3PDT	LW7S-2LC3	LW7S-2LC3V	—			
			Silver	SPDT	LW7S-2LC5	—	—			
				DPDT	LW7S-2LC6	—	LW7S-2LC6M			
				3PDT	LW7S-2LC7	—	—			
	90° 2-position Spring Return from Right		Gold	SPDT	LW7S-21LC1	LW7S-21LC1V	—			
				DPDT	LW7S-21LC2	LW7S-21LC2V	LW7S-21LC2M			
				3PDT	LW7S-21LC3	LW7S-21LC3V	—			
			Silver	SPDT	LW7S-21LC5	—	—			
				DPDT	LW7S-21LC6	—	LW7S-21LC6M			
				3PDT	LW7S-21LC7	—	—			
	45° 3-position Maintained		Gold	DPDT	LW7S-3LC2	LW7S-3LC2V	LW7S-3LC2M			
				3PDT	LW7S-3LC3	LW7S-3LC3V	—			
				Silver	DPDT	LW7S-3LC6	—	LW7S-3LC6M		
			Silver	3PDT	LW7S-3LC7	—	—			
				45° 3-position Spring Return Two-way		Gold	DPDT	LW7S-33LC2	LW7S-33LC2V	LW7S-33LC2M
							3PDT	LW7S-33LC3	LW7S-33LC3V	—
Silver	DPDT	LW7S-33LC6	—				LW7S-33LC6M			
Silver	3PDT	LW7S-33LC7	—			—				

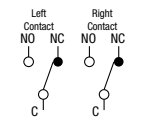
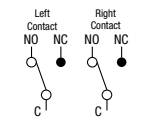
## Contact Operation

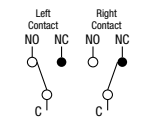
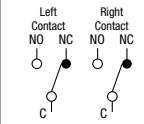
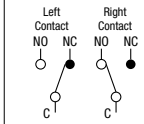
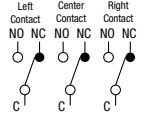
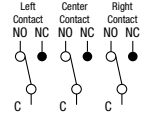
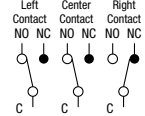
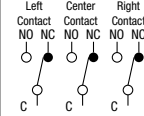
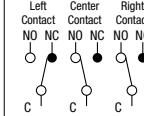
Operation	Contact	Operator Position and Contact Position (Top View)		Operation	Contact	Operator Position and Contact Position (Top View)		
		Left	Right			Left	Center	Right
 90° 2-Position	SPDT DPDT			 45° 3-Position	DPDT			
	3PDT				3PDT			

• SPDT has C, NO, and NC only in the center of the terminal.

Dimensions

All dimensions in mm.

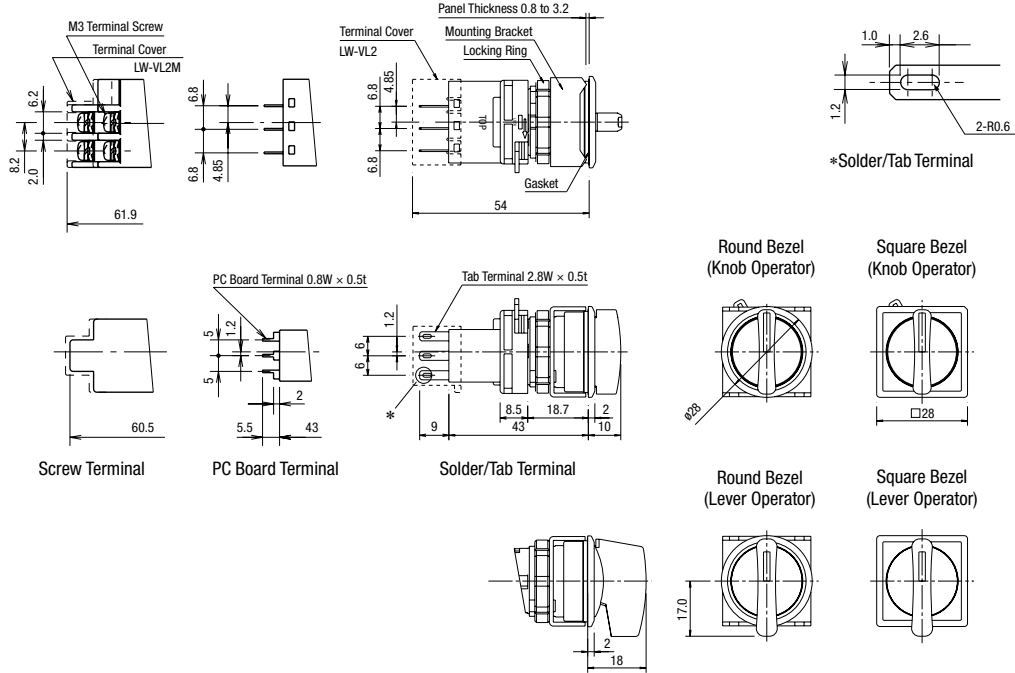

Bottom View

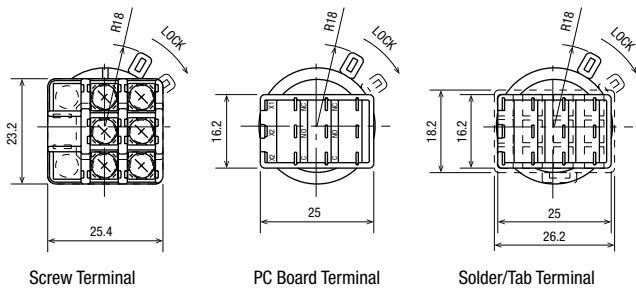

Note: Dotted lines are dimensions for terminal cover (LW-VL2).

PC Board Drilling Layout (Bottom View)

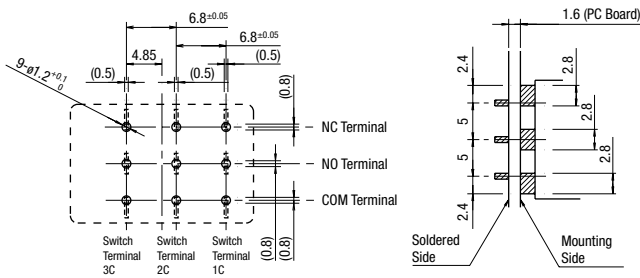

Note the pattern of the PC board as the terminals on the mounting surface are 2.8 mm wide.

Terminal Arrangement (Bottom View)

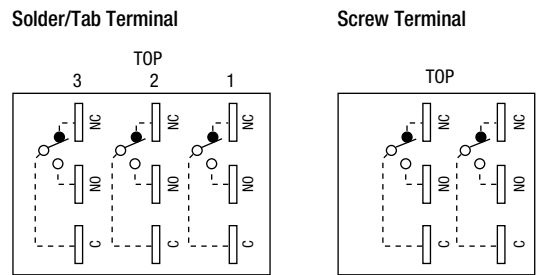

Note: SPDT has C, NO, and NC only in the center. DPDT has C, NO, and NC only on the right and left. Screw terminal is only available in DPDT configuration.

Applicable Crimping Terminal

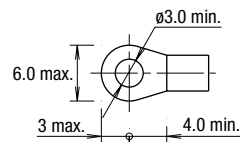

- APEM
- Switches & Pilot Lights
- Control Boxes
- Emergency Stop Switches
- Enabling Switches
- Safety Products
- Explosion Proof
- Terminal Blocks
- Relays & Sockets
- Circuit Protectors
- Power Supplies
- LED Illumination
- Controllers
- Operator Interfaces
- Sensors
- AUTO-ID

Flush Silhouette

ø16

ø22

ø30

Miniature

Pilot Lights

CW

LW-F

LB





LBW

UP

Flush Bezel

## Illuminated Selector Switches with Round Metal Bezel

Package Quantity: 1



Shape	Operation	Position	Contact Material	Contact	Part No.			
					Solder/Tab Terminal	PC Board Terminal	Screw Terminal	
Round Metal Bezel LW6MF (Knob Operator) 	90° 2-position Maintained		Gold	SPDT	LW6MF-2C1③②	LW6MF-2C1③V②	—	
				DPDT	LW6MF-2C2③②	LW6MF-2C2③V②	LW6MF-2C2③M②	
				3PDT	LW6MF-2C3③②	LW6MF-2C3③V②	—	
			Silver	SPDT	LW6MF-2C5③②	—	—	
				DPDT	LW6MF-2C6③②	—	LW6MF-2C6③M②	
				3PDT	LW6MF-2C7③②	—	—	
	90° 2-position Spring Return from Right		Gold	SPDT	LW6MF-21C1③②	LW6MF-21C1③V②	—	
				DPDT	LW6MF-21C2③②	LW6MF-21C2③V②	LW6MF-21C2③M②	
				3PDT	LW6MF-21C3③②	LW6MF-21C3③V②	—	
			Silver	SPDT	LW6MF-21C5③②	—	—	
				DPDT	LW6MF-21C6③②	—	LW6MF-21C6③M②	
				3PDT	LW6MF-21C7③②	—	—	
	45° 3-position Maintained		Gold	DPDT	LW6MF-3C2③②	LW6MF-3C2③V②	LW6MF-3C2③M②	
				3PDT	LW6MF-3C3③②	LW6MF-3C3③V②	—	
				Silver	DPDT	LW6MF-3C6③②	—	LW6MF-3C6③M②
			3PDT		LW6MF-3C7③②	—	—	
45° 3-position Spring Return Two-way					Gold	DPDT	LW6MF-33C2③②	LW6MF-33C2③V②
				3PDT		LW6MF-33C3③②	LW6MF-33C3③V②	—
	Silver	DPDT		LW6MF-33C6③②		—	LW6MF-33C6③M②	
		3PDT		LW6MF-33C7③②	—	—		

## Color Code and Operating Voltage Code

② Lens/LED Color Code	③ Operating Voltage Code
Specify a Lens/LED color code in place of ② in the Part No. A: amber G: green PW: pure white R: red S: blue	Specify an operating voltage code in place of ③ in the Part No. 2: 6V AC/DC 3: 12V AC/DC 4: 24V AC/DC

- Every illuminated selector switch contains an LED lamp (LSTD) of the specified color and voltage.
- For replacement LED lamps, see **B-064**.

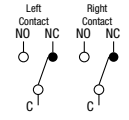
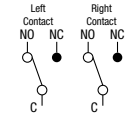
## Contact Operation

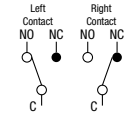
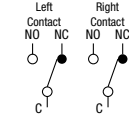
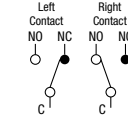
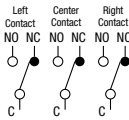
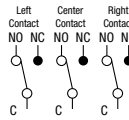
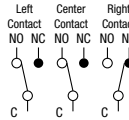
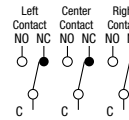
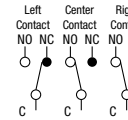
Operation	Contact	Operator Position and Contact Position (Top View)		Operation	Contact	Operator Position and Contact Position (Top View)		
		Left	Right			Left	Center	Right
 90° 2-Position	SPDT DPDT			 45° 3-Position	DPDT			
	3PDT				3PDT			

- SPDT has C, NO, and NC only in the center of the terminal.

Illuminated Selector Switches with Black Plastic Bezel

Package Quantity: 1

Shape	Operation	Position	Contact Material	Contact	Part No.		
					Solder/Tab Terminal	PC Board Terminal	Screw Terminal
Round Black Plastic Bezel LW6F (Knob Operator)	90° 2-position Maintained		Gold	SPDT	LW6F-2C1③②	LW6F-2C1③V②	—
				DPDT	LW6F-2C2③②	LW6F-2C2③V②	LW6F-2C2③M②
				3PDT	LW6F-2C3③②	LW6F-2C3③V②	—
			Silver	SPDT	LW6F-2C5③②	—	—
				DPDT	LW6F-2C6③②	—	LW6F-2C6③M②
				3PDT	LW6F-2C7③②	—	—
	90° 2-position Spring Return from Right		Gold	SPDT	LW6F-21C1③②	LW6F-21C1③V②	—
				DPDT	LW6F-21C2③②	LW6F-21C2③V②	LW6F-21C2③M②
				3PDT	LW6F-21C3③②	LW6F-21C3③V②	—
			Silver	SPDT	LW6F-21C5③②	—	—
				DPDT	LW6F-21C6③②	—	LW6F-21C6③M②
				3PDT	LW6F-21C7③②	—	—
	45° 3-position Maintained		Gold	DPDT	LW6F-3C2③②	LW6F-3C2③V②	LW6F-3C2③M②
				3PDT	LW6F-3C3③②	LW6F-3C3③V②	—
			Silver	DPDT	LW6F-3C6③②	—	LW6F-3C6③M②
				3PDT	LW6F-3C7③②	—	—
45° 3-position Spring Return Two-way		Gold	DPDT	LW6F-33C2③②	LW6F-33C2③V②	LW6F-33C2③M②	
			3PDT	LW6F-33C3③②	LW6F-33C3③V②	—	
		Silver	DPDT	LW6F-33C6③②	—	LW6F-33C6③M②	
			3PDT	LW6F-33C7③②	—	—	

Color Code and Operating Voltage Code

② Lens/LED Color Code	③ Operating Voltage Code
Specify a Lens/LED color code in place of ② in the Part No. A: amber G: green PW: pure white R: red S: blue	Specify an operating voltage code in place of ③ in the Part No. 2: 6V AC/DC 3: 12V AC/DC 4: 24V AC/DC

- Every illuminated selector switch contains an LED lamp (LSTD) of the specified color and voltage.
- For replacement LED lamps, see B-064.

Contact Operation

Operation	Contact	Operator Position and Contact Position (Top View)		Operation	Contact	Operator Position and Contact Position (Top View)		
		Left	Right			Left	Center	Right
	SPDT DPDT				DPDT			
	3PDT					3PDT		

- SPDT has C, NO, and NC only in the center of the terminal.



## Illuminated Selector Switches with Square Black Plastic Bezel

Package Quantity: 1

Shape	Operation	Position	Contact Material	Contact	Part No.			
					Solder/Tab Terminal	PC Board Terminal	Screw Terminal	
Square Black Plastic Bezel LW7F (Knob Operator)	90° 2-position Maintained		Gold	SPDT	LW7F-2C1③②	LW7F-2C1③V②	—	
				DPDT	LW7F-2C2③②	LW7F-2C2③V②	LW7F-2C2③M②	
				3PDT	LW7F-2C3③②	LW7F-2C3③V②	—	
			Silver	SPDT	LW7F-2C5③②	—	—	
				DPDT	LW7F-2C6③②	—	LW7F-2C6③M②	
				3PDT	LW7F-2C7③②	—	—	
	90° 2-position Spring Return from Right		Gold	SPDT	LW7F-21C1③②	LW7F-21C1③V②	—	
				DPDT	LW7F-21C2③②	LW7F-21C2③V②	LW7F-21C2③M②	
				3PDT	LW7F-21C3③②	LW7F-21C3③V②	—	
			Silver	SPDT	LW7F-21C5③②	—	—	
				DPDT	LW7F-21C6③②	—	LW7F-21C6③M②	
				3PDT	LW7F-21C7③②	—	—	
45° 3-position Maintained		Gold	DPDT	LW7F-3C2③②	LW7F-3C2③V②	LW7F-3C2③M②		
			3PDT	LW7F-3C3③②	LW7F-3C3③V②	—		
		Silver	DPDT	LW7F-3C6③②	—	LW7F-3C6③M②		
			3PDT	LW7F-3C7③②	—	—		
		45° 3-position Spring Return Two-way		Gold	DPDT	LW7F-33C2③②	LW7F-33C2③V②	LW7F-33C2③M②
					3PDT	LW7F-33C3③②	LW7F-33C3③V②	—
Silver	DPDT	LW7F-33C6③②	—	LW7F-33C6③M②				
	3PDT	LW7F-33C7③②	—	—				



### Color Code and Operating Voltage Code

② Lens/LED Color Code	③ Operating Voltage Code
Specify a Lens/LED color code in place of ② in the Part No.	Specify an operating voltage code in place of ③ in the Part No.
A: amber G: green PW: pure white R: red S: blue Y: yellow	2: 6V AC/DC 3: 12V AC/DC 4: 24V AC/DC

- Every illuminated selector switch contains an LED lamp (LSTD) of the specified color and voltage. A pure white LED lamp is used for yellow illumination.
- For replacement LED lamps, see **B-064**.

### Contact Operation

Operation	Contact	Operator Position and Contact Position (Top View)		Operation	Contact	Operator Position and Contact Position (Top View)		
		Left	Right			Left	Center	Right
90° 2-Position	SPDT DPDT			45° 3-Position	DPDT			
	3PDT							

- SPDT has C, NO, and NC only in the center of the terminal.

Dimensions

All dimensions in mm.

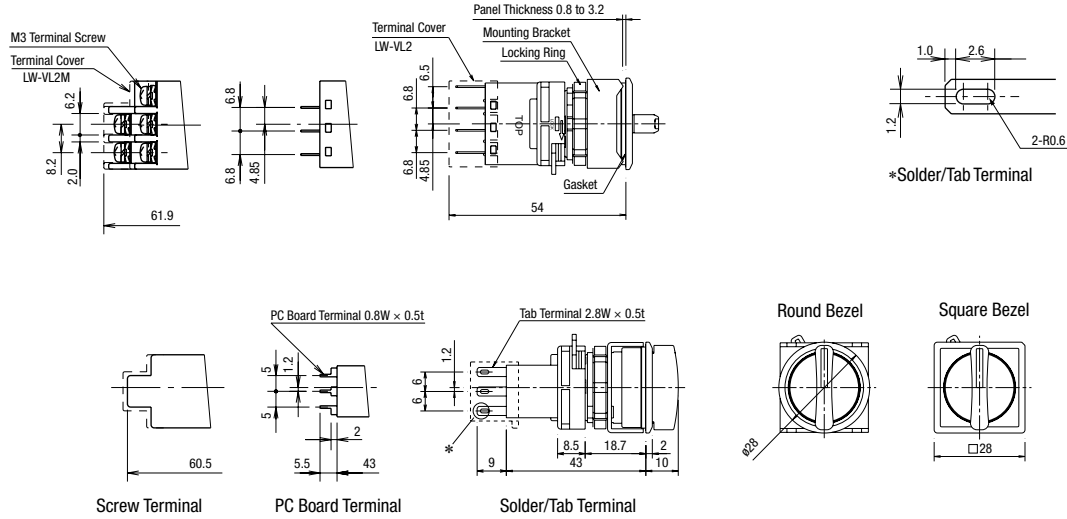

Bottom View

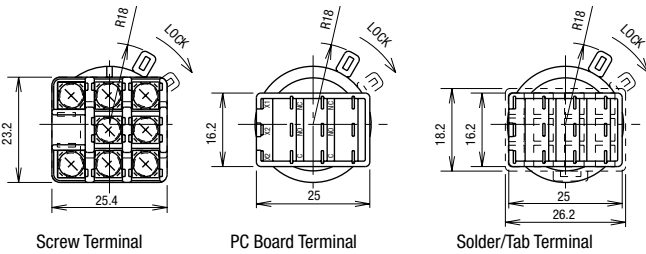

Note: Dotted lines are dimensions for terminal cover (LW-VL2).

Terminal Arrangement (Bottom View)

Solder/Tab Terminal

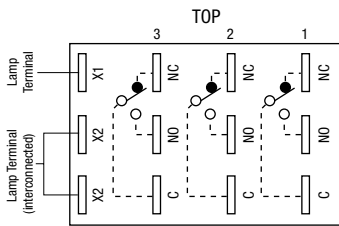

Note: SPDT has C, NO, and NC only in the center. DPDT has C, NO, and NC only on the right and left. Lamp terminals do not have any polarity.

Screw Terminal

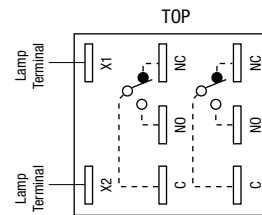

PC Board Drilling Layout (Bottom View)

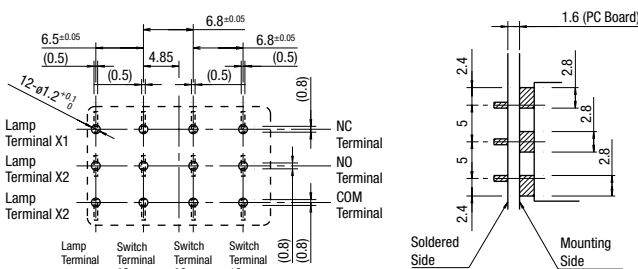

Note the pattern of the PC board as the terminals on the mounting surface are 2.8 mm wide.

Applicable Crimping Terminal

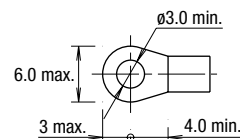

APEM

Switches & Pilot Lights

Control Boxes

Emergency Stop Switches

Enabling Switches

Safety Products

Explosion Proof

Terminal Blocks

Relays & Sockets

Circuit Protectors

Power Supplies

LED Illumination

Controllers

Operator Interfaces

Sensors

AUTO-ID

Flush Silhouette

ø16

ø22

ø30

Miniature

Pilot Lights

CW

LW-F

LB

LBW

UP

Flush Bezel



Download catalogs and CAD from <http://eu.idec.com/downloads>

## Key Selector Switches with Round Metal Bezel (2-Position)

Package Quantity: 1



Shape	Operation	Key retained at ●	Contact Material	Contact	Part No.		
					Solder/Tab Terminal	PC Board Terminal	Screw Terminal
 Round Metal Bezel LW6MK	90° 2-position Maintained	A	Gold	SPDT	LW6MK-2C1A	LW6MK-2C1VA	—
				DPDT	LW6MK-2C2A	LW6MK-2C2VA	LW6MK-2C2MA
				3PDT	LW6MK-2C3A	LW6MK-2C3VA	—
			Silver	SPDT	LW6MK-2C5A	—	—
				DPDT	LW6MK-2C6A	—	LW6MK-2C6MA
				3PDT	LW6MK-2C7A	—	—
		B	Gold	SPDT	LW6MK-2C1B	LW6MK-2C1VB	—
				DPDT	LW6MK-2C2B	LW6MK-2C2VB	LW6MK-2C2MB
				3PDT	LW6MK-2C3B	LW6MK-2C3VB	—
			Silver	SPDT	LW6MK-2C5B	—	—
				DPDT	LW6MK-2C6B	—	LW6MK-2C6MB
				3PDT	LW6MK-2C7B	—	—
	C	Gold	SPDT	LW6MK-2C1C	LW6MK-2C1VC	—	
			DPDT	LW6MK-2C2C	LW6MK-2C2VC	LW6MK-2C2MC	
			3PDT	LW6MK-2C3C	LW6MK-2C3VC	—	
		Silver	SPDT	LW6MK-2C5C	—	—	
			DPDT	LW6MK-2C6C	—	LW6MK-2C6MC	
			3PDT	LW6MK-2C7C	—	—	
	90° 2-position Spring Return from Right	B	Gold	SPDT	LW6MK-21C1B	LW6MK-21C1VB	—
				DPDT	LW6MK-21C2B	LW6MK-21C2VB	LW6MK-21C2MB
				3PDT	LW6MK-21C3B	LW6MK-21C3VB	—
			Silver	SPDT	LW6MK-21C5B	—	—
				DPDT	LW6MK-21C6B	—	LW6MK-21C6MB
				3PDT	LW6MK-21C7B	—	—

- Key is retained in ● position and removable in ○ position.
- Two keys are supplied.
- Key cylinder face material: Metal
- To select key numbers, specify numbers 501 to 503 after the Part No. When a key number is not specified, key number 500 is supplied the default key.

Example: LW6MK-2C1A-501

500 (default key) to 503

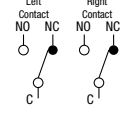
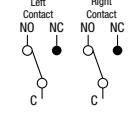
### Contact Operation

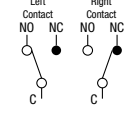
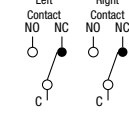
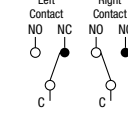
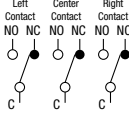
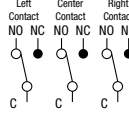
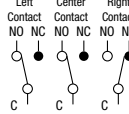
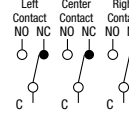
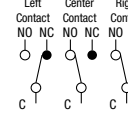
Operation	Contact	Operator Position and Contact Position (Top View)		Operation	Contact	Operator Position and Contact Position (Top View)		
		Left	Right			Left	Center	Right
 90° 2-Position	SPDT DPDT			 45° 3-Position	DPDT			
	3PDT				3PDT			

Key Selector Switches with Round Metal Bezel (3-Position)

Package Quantity: 1

Shape	Operation	Key retained at ●	Contact Material	Contact	Part No.			
					Solder/Tab Terminal	PC Board Terminal	Screw Terminal	
Round Metal Bezel LW6MK	45° 3-position Maintained	A	Gold	DPDT	LW6MK-3C2A	LW6MK-3C2VA	LW6MK-3C2MA	
				3PDT	LW6MK-3C3A	LW6MK-3C3VA	—	
				Silver	DPDT	LW6MK-3C6A	—	LW6MK-3C6MA
			3PDT	LW6MK-3C7A	—	—		
			B	Gold	DPDT	LW6MK-3C2B	LW6MK-3C2VB	LW6MK-3C2MB
				3PDT	LW6MK-3C3B	LW6MK-3C3VB	—	
		Silver		DPDT	LW6MK-3C6B	—	LW6MK-3C6MB	
		3PDT	LW6MK-3C7B	—	—			
		C	Gold	DPDT	LW6MK-3C2C	LW6MK-3C2VC	LW6MK-3C2MC	
			3PDT	LW6MK-3C3C	LW6MK-3C3VC	—		
			Silver	DPDT	LW6MK-3C6C	—	LW6MK-3C6MC	
		3PDT	LW6MK-3C7C	—	—			
	D	Gold	DPDT	LW6MK-3C2D	LW6MK-3C2VD	LW6MK-3C2MD		
		3PDT	LW6MK-3C3D	LW6MK-3C3VD	—			
		Silver	DPDT	LW6MK-3C6D	—	LW6MK-3C6MD		
	3PDT	LW6MK-3C7D	—	—				
	E	Gold	DPDT	LW6MK-3C2E	LW6MK-3C2VE	LW6MK-3C2ME		
		3PDT	LW6MK-3C3E	LW6MK-3C3VE	—			
		Silver	DPDT	LW6MK-3C6E	—	LW6MK-3C6ME		
	3PDT	LW6MK-3C7E	—	—				
	G	Gold	DPDT	LW6MK-3C2G	LW6MK-3C2VG	LW6MK-3C2MG		
		3PDT	LW6MK-3C3G	LW6MK-3C3VG	—			
		Silver	DPDT	LW6MK-3C6G	—	LW6MK-3C6MG		
	3PDT	LW6MK-3C7G	—	—				
H	Gold	DPDT	LW6MK-3C2H	LW6MK-3C2VH	LW6MK-3C2MH			
	3PDT	LW6MK-3C3H	LW6MK-3C3VH	—				
	Silver	DPDT	LW6MK-3C6H	—	LW6MK-3C6MH			
3PDT	LW6MK-3C7H	—	—					
45° 3-position Spring Return from Right	B	Gold	DPDT	LW6MK-31C2B	LW6MK-31C2VB	LW6MK-31C2MB		
			3PDT	LW6MK-31C3B	LW6MK-31C3VB	—		
			Silver	DPDT	LW6MK-31C6B	—	LW6MK-31C6MB	
		3PDT	LW6MK-31C7B	—	—			
		D	Gold	DPDT	LW6MK-31C2D	LW6MK-31C2VD	LW6MK-31C2MD	
			3PDT	LW6MK-31C3D	LW6MK-31C3VD	—		
	Silver		DPDT	LW6MK-31C6D	—	LW6MK-31C6MD		
	3PDT	LW6MK-31C7D	—	—				
	G	Gold	DPDT	LW6MK-31C2G	LW6MK-31C2VG	LW6MK-31C2MG		
		3PDT	LW6MK-31C3G	LW6MK-31C3VG	—			
		Silver	DPDT	LW6MK-31C6G	—	LW6MK-31C6MG		
	3PDT	LW6MK-31C7G	—	—				



APEM

Switches & Pilot Lights

Control Boxes

Emergency Stop Switches

Enabling Switches

Safety Products

Explosion Proof

Terminal Blocks

Relays & Sockets

Circuit Protectors

Power Supplies

LED Illumination

Controllers

Operator Interfaces

Sensors

AUTO-ID

Flush Silhouette

ø16

ø22

ø30

Miniature

Pilot Lights

CW

LW-F

LB

LBW



UP

Flush Bezel



## Key Selector Switches with Round Metal Bezel (3-Position)

Package Quantity: 1



Shape	Operation	Key retained at ●	Contact Material	Contact	Part No.		
					Solder/Tab Terminal	PC Board Terminal	Screw Terminal
Round Metal Bezel LW6MK 	45° 3-position Spring Return Two-way	D 	Gold	DPDT	LW6MK-33C2D	LW6MK-33C2VD	LW6MK-33C2MD
				3PDT	LW6MK-33C3D	LW6MK-33C3VD	—
				DPDT	LW6MK-33C6D	—	LW6MK-33C6MD
				3PDT	LW6MK-33C7D	—	—

- Key is retained in ● position and removable in ○ position.
- Two keys are supplied.
- Key cylinder face material: Metal
- To select key numbers, specify numbers 501 to 503 after the Part No. When a key number is not specified, key number 500 is supplied the default key.

Example: LW6MK-2C1A-501

— 500 (default key) to 503

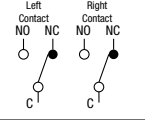
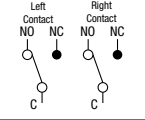
## Contact Operation

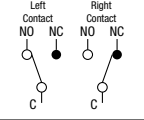
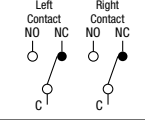
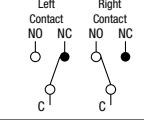
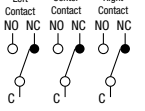
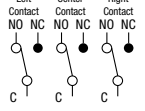
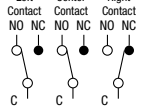
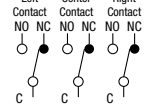
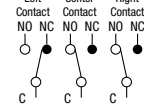
Operation	Contact	Operator Position and Contact Position (Top View)		Operation	Contact	Operator Position and Contact Position (Top View)		
		Left	Right			Left	Center	Right
 90° 2-Position	SPDT DPDT			 45° 3-Position	DPDT			
	3PDT				3PDT			

Key Selector Switches with Black Plastic Bezel (2-Position)



Package Quantity: 1

Shape	Operation	Key retained at ●	Contact Material	Contact	Part No.		
					Solder/Tab Terminal	PC Board Terminal	Screw Terminal
Round Black Plastic Bezel LW6K 	90° 2-position Maintained	A	Gold	SPDT	LW6K-2C1A	LW6K-2C1VA	—
				DPDT	LW6K-2C2A	LW6K-2C2VA	LW6K-2C2MA
				3PDT	LW6K-2C3A	LW6K-2C3VA	—
			Silver	SPDT	LW6K-2C5A	—	—
				DPDT	LW6K-2C6A	—	LW6K-2C6MA
				3PDT	LW6K-2C7A	—	—
		B	Gold	SPDT	LW6K-2C1B	LW6K-2C1VB	—
				DPDT	LW6K-2C2B	LW6K-2C2VB	LW6K-2C2MB
				3PDT	LW6K-2C3B	LW6K-2C3VB	—
			Silver	SPDT	LW6K-2C5B	—	—
				DPDT	LW6K-2C6B	—	LW6K-2C6MB
				3PDT	LW6K-2C7B	—	—
	C	Gold	SPDT	LW6K-2C1C	LW6K-2C1VC	—	
			DPDT	LW6K-2C2C	LW6K-2C2VC	LW6K-2C2MC	
			3PDT	LW6K-2C3C	LW6K-2C3VC	—	
		Silver	SPDT	LW6K-2C5C	—	—	
			DPDT	LW6K-2C6C	—	LW6K-2C6MC	
			3PDT	LW6K-2C7C	—	—	
	90° 2-position Spring Return from Right	B	Gold	SPDT	LW6K-21C1B	LW6K-21C1VB	—
				DPDT	LW6K-21C2B	LW6K-21C2VB	LW6K-21C2MB
				3PDT	LW6K-21C3B	LW6K-21C3VB	—
			Silver	SPDT	LW6K-21C5B	—	—
				DPDT	LW6K-21C6B	—	LW6K-21C6MB
				3PDT	LW6K-21C7B	—	—

- Key is retained in ● position and removable in ○ position.
- Two keys are supplied.
- Key cylinder face material: Metal
- To select key numbers, specify numbers 501 to 503 after the Part No. When a key number is not specified, key number 500 is supplied the default key.

Example: LW6K-2C1A-501  
 500 (default key) to 503

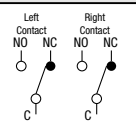
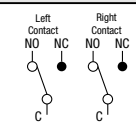
Contact Operation

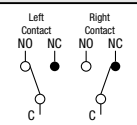
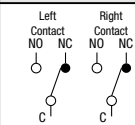
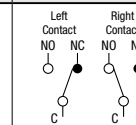
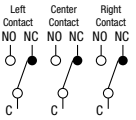
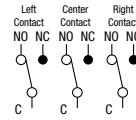
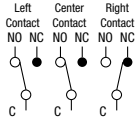
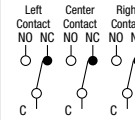
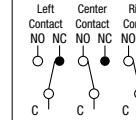
Operation	Contact	Operator Position and Contact Position (Top View)		Operation	Contact	Operator Position and Contact Position (Top View)		
		Left	Right			Left	Center	Right
90° 2-Position 	SPDT DPDT			45° 3-Position 	DPDT			
	3PDT				3PDT			

APEM

Switches & Pilot Lights

Control Boxes

Emergency Stop Switches

Enabling Switches

Safety Products

Explosion Proof

Terminal Blocks

Relays & Sockets

Circuit Protectors

Power Supplies

LED Illumination

Controllers

Operator Interfaces

Sensors

AUTO-ID

Flush Silhouette

ø16

ø22

ø30

Miniature

Pilot Lights

CW

LW-F

LB









LBW

UP

Flush Bezel

## Key Selector Switches with Black Plastic Bezel (3-Position)

Package Quantity: 1

Shape	Operation	Key retained at ●	Contact Material	Contact	Part No.			
					Solder/Tab Terminal	PC Board Terminal	Screw Terminal	
Round Black Plastic Bezel LW6K  	45° 3-position Maintained	A 	Gold	DPDT	LW6K-3C2A	LW6K-3C2VA	LW6K-3C2MA	
				3PDT	LW6K-3C3A	LW6K-3C3VA	—	
			Silver	DPDT	LW6K-3C6A	—	LW6K-3C6MA	
				3PDT	LW6K-3C7A	—	—	
			B 	Gold	DPDT	LW6K-3C2B	LW6K-3C2VB	LW6K-3C2MB
					3PDT	LW6K-3C3B	LW6K-3C3VB	—
		Silver		DPDT	LW6K-3C6B	—	LW6K-3C6MB	
				3PDT	LW6K-3C7B	—	—	
		C 		Gold	DPDT	LW6K-3C2C	LW6K-3C2VC	LW6K-3C2MC
					3PDT	LW6K-3C3C	LW6K-3C3VC	—
			Silver	DPDT	LW6K-3C6C	—	LW6K-3C6MC	
				3PDT	LW6K-3C7C	—	—	
			D 	Gold	DPDT	LW6K-3C2D	LW6K-3C2VD	LW6K-3C2MD
					3PDT	LW6K-3C3D	LW6K-3C3VD	—
		Silver		DPDT	LW6K-3C6D	—	LW6K-3C6MD	
				3PDT	LW6K-3C7D	—	—	
		E 		Gold	DPDT	LW6K-3C2E	LW6K-3C2VE	LW6K-3C2ME
					3PDT	LW6K-3C3E	LW6K-3C3VE	—
			Silver	DPDT	LW6K-3C6E	—	LW6K-3C6ME	
				3PDT	LW6K-3C7E	—	—	
			G 	Gold	DPDT	LW6K-3C2G	LW6K-3C2VG	LW6K-3C2MG
					3PDT	LW6K-3C3G	LW6K-3C3VG	—
		Silver		DPDT	LW6K-3C6G	—	LW6K-3C6MG	
				3PDT	LW6K-3C7G	—	—	
H 	Gold	DPDT		LW6K-3C2H	LW6K-3C2VH	LW6K-3C2MH		
		3PDT		LW6K-3C3H	LW6K-3C3VH	—		
	Silver	DPDT	LW6K-3C6H	—	LW6K-3C6MH			
		3PDT	LW6K-3C7H	—	—			

## Flush Silhouette

ø16

ø22

ø30

Miniature

Pilot Lights

CW

LW-F

LB



LBW

UP

Flush Bezel



Key Selector Switches with Black Plastic Bezel (3-Position)

Package Quantity: 1

Shape	Operation	Key retained at ●	Contact Material	Contact	Part No.		
					Solder/Tab Terminal	PC Board Terminal	Screw Terminal
Round Black Plastic Bezel LW6K 	45° 3-position Spring Return Two-way	D 	Gold	DPDT	LW6K-33C2D	LW6K-33C2VD	LW6K-33C2MD
				3PDT	LW6K-33C3D	LW6K-33C3VD	—
				DPDT	LW6K-33C6D	—	LW6K-33C6MD
				3PDT	LW6K-33C7D	—	—

- Key is retained in ● position and removable in ○ position.
  - Two keys are supplied.
  - Key cylinder face material: Metal
  - To select key numbers, specify numbers 501 to 503 after the Part No. When a key number is not specified, key number 500 is supplied the default key.
- Example: LW6MK-2C1A-501  
 500 (default key) to 503

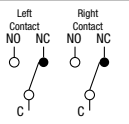
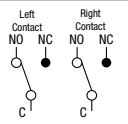
Contact Operation

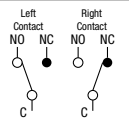
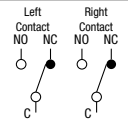
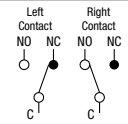
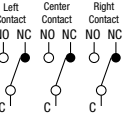
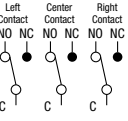
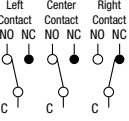
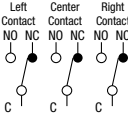
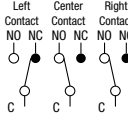
Operation	Contact	Operator Position and Contact Position (Top View)		Operation	Contact	Operator Position and Contact Position (Top View)		
		Left	Right			Left	Center	Right
90° 2-Position 	SPDT DPDT			45° 3-Position 	DPDT			
	3PDT				3PDT			

- APEM
- Switches & Pilot Lights
- Control Boxes
- Emergency Stop Switches
- Enabling Switches
- Safety Products
- Explosion Proof
- Terminal Blocks
- Relays & Sockets
- Circuit Protectors
- Power Supplies
- LED Illumination
- Controllers
- Operator Interfaces
- Sensors
- AUTO-ID
- Flush Silhouette
- ø16
- ø22
- ø30
- Miniature
- Pilot Lights
- CW
- LW-F
- LB
- LBW
- UP
- Flush Bezel



# Flush Silhouette Switches LW Series

## Dimensions

All dimensions in mm.

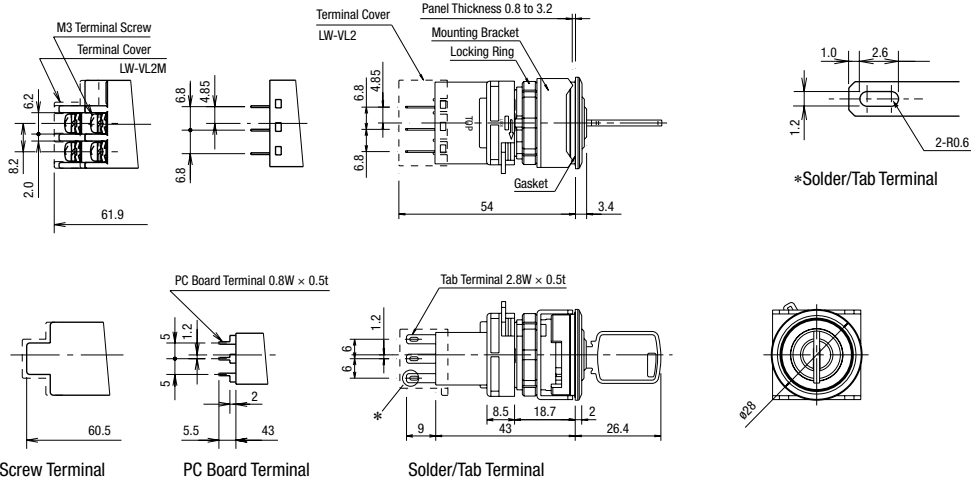

## Bottom View

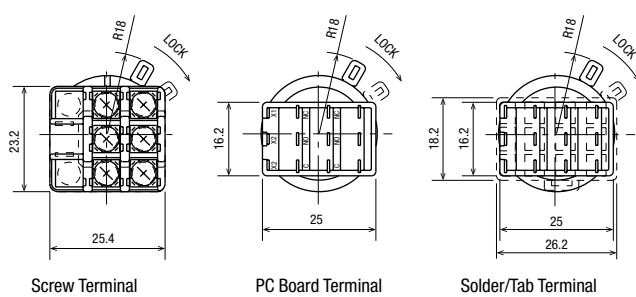

Note: Dotted lines are dimensions for terminal cover (LW-VL2).

## Terminal Arrangement (Bottom View)

### Solder / Tab Terminal / PC Board Terminal

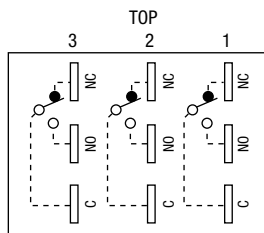

Note:  
 SPDT has C, NO, and NC only in the center.  
 DPDT has C, NO, and NC only on the right and left.  
 Screw terminal is only available in DPDT configuration.

### Screw Terminal

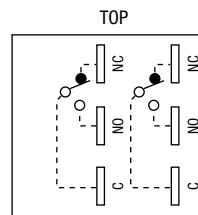

## PC Board Drilling Layout (Bottom View)

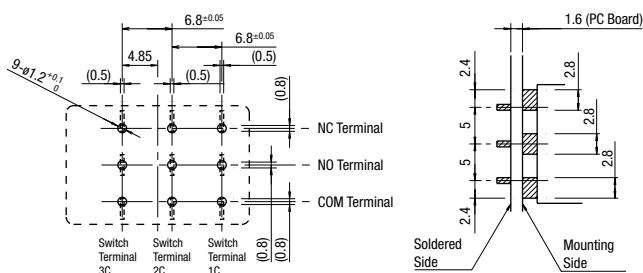



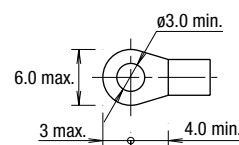







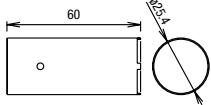

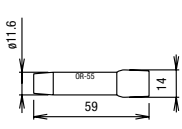

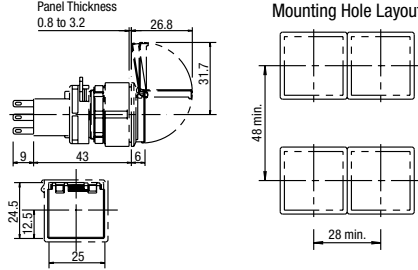
## Applicable Crimping Terminal

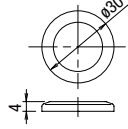

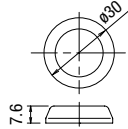
Note the pattern of the PC board as the terminals on the mounting surface are 2.8 mm wide.

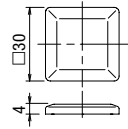

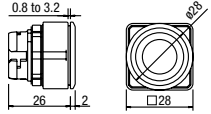

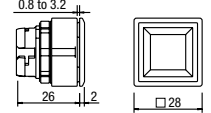

Accessories

Package Quantity: 1

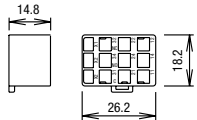
Shape	Material	Part No.	Dimensions (mm)
	Metal (nickel-plated brass)	LW9Z-T1	<ul style="list-style-type: none"> <li>Used to tighten the locking ring when installing the control unit into a panel.</li> <li>Tightening torque: 1.2 N·m</li> </ul> 
	Rubber (black) (Nitril)	OR-55	<ul style="list-style-type: none"> <li>Used to install and remove LED lamps.</li> </ul> 
	Rubber (Ring: metal)	MT-S01	<ul style="list-style-type: none"> <li>Used to remove the lens.</li> </ul>
	Polyarylate (Guard: transparent)	LW9Z-KS7②	<ul style="list-style-type: none"> <li>Switch guard accessory comes with lens.</li> <li>Cannot be used with maintained types (momentary buttons only).</li> <li>Specify a lens color code in place of ② in the Part No. A: amber, C: clear, G: green, PW (pure white), R: red, S: blue, Y: yellow</li> <li>Use a clear lens for white illumination or for white (LW) or black (LB) buttons.</li> </ul>  <p>Note: Determine mounting centers to ensure easy operation.</p>
		LW9Z-D61	<ul style="list-style-type: none"> <li>Degree of protection: IP65</li> <li>Panel thickness: 0.8 to 3.2 mm</li> </ul> 
	Rubber (transparent silicon rubber)	LW9Z-D62	<ul style="list-style-type: none"> <li>Degree of protection: IP65</li> <li>Panel thickness: 0.8 to 3.2 mm</li> </ul> 
		LW9Z-D71	<ul style="list-style-type: none"> <li>Degree of protection: IP65</li> <li>Panel thickness: 0.8 to 3.2 mm</li> </ul> 
	Plug: Polyamide (black) Gasket: Nitril Mounting bracket: PBT	LW9Z-BS6	<ul style="list-style-type: none"> <li>Degree of protection: IP65</li> <li>Panel thickness: 0.8 to 3.2 mm</li> <li>See B-031 for mounting hole layout.</li> </ul> 
	Plug: Polyamide (black) Gasket: Nitril Mounting bracket: PBT	LW9Z-BS7	<ul style="list-style-type: none"> <li>Degree of protection: IP65</li> <li>Panel thickness: 0.8 to 3.2 mm</li> <li>See B-031 for mounting hole layout.</li> </ul> 

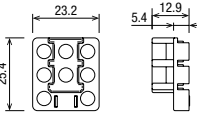
## Accessories

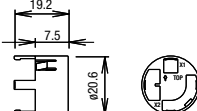
Package Quantity: 1

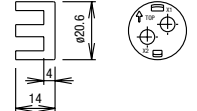
Shape	Material	Part No.	Dimensions (mm)
Terminal Cover For Solder/Tab Terminal 	Polyamide (translucent)	LW-VL2	• For units with removable contact block only. 
Terminal Cover For Screw Terminal 	Polyamide (black)	LW-VL2M	• For units with removable contact block only. 
Terminal Cover For Solder/Tab Terminal 	Polyamide (translucent)	LW-PVL	• For unibody pilot lights only. 
Terminal Cover For Screw Terminal 	Polyamide (translucent)	LW-PVLM	• For unibody pilot lights only. 

## Transformer

Shape	Primary Voltage	Secondary Voltage	Part No.	Applicable Load
For 6V 	100/110V AC	5.5V AC, 1W	TWR516	LSTD-6 LED lamp (6V AC/DC) or LS-6 incandescent lamp (6V AC/DC, 1W)
	115/120V AC		TWR5126	
	200/220V AC		TWR526	
	230/240V AC		TWR5246	
	380V AC		TWR5386	
	400/440V AC		TWR546	
	480V AC		TWR5486	

## Specifications

Operating Voltage	100/110V AC, 115/120V AC, 200/220V AC, 230/240V AC, 380V AC, 400/440V AC, 480V AC (50/60Hz)
Current Draw	2.4 VA
Rated Insulation Voltage	600V
Insulation Resistance	100 MΩ minimum (500V DC megger)
Operating Temperature	-30 to +60°C (no freezing)
Operating Humidity	35 to 85% RH (no condensation)
Vibration Resistance	Operating extremes: 5 to 55 Hz, amplitude 0.5 mm
Shock Resistance	Damage limits: 1,000 m/s <sup>2</sup>
Dielectric Strength	2,500V AC, 1 minute
Terminal Screw	M3.5
Applicable Wire	2 mm <sup>2</sup> maximum, 2 wires maximum

## Dimensions

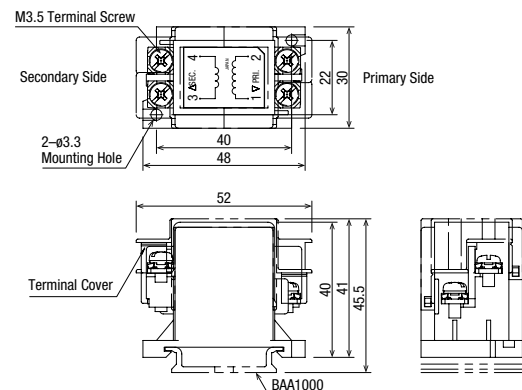

## Accessories

## DIN Rail

Part No.	Ordering No.	Length	Weight (approx.)	Material	Package Quantity
BAA1000	BAA1000PN10	1000 mm	200g	Aluminum	10
BAP1000	BAP1000PN10	1000 mm	320g	Steel	10

## End Clip

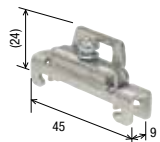
Part No.	Ordering No.	Applicable DIN Rail	Weight (approx.)	Material	Package Quantity	Dimensions
BNL6	BNL6PN10	BAA1000 BAP1000	15g	Steel (Zinc-plated)	10	

• See H-071 for DIN rail products.

For more information, visit <http://eu.idec.com>

APEM

Switches & Pilot Lights

Control Boxes

Emergency Stop Switches

Enabling Switches

Safety Products

Explosion Proof

Terminal Blocks

Relays & Sockets

Circuit Protectors

Power Supplies

LED Illumination

Controllers

Operator Interfaces

Sensors

AUTO-ID

Flush Silhouette

ø16

ø22

ø30

Miniature

Pilot Lights

CW

LW-F

LB

LBW











UP

Flush Bezel

Maintenance Parts

All dimensions in mm.

When ordering, specify the Ordering No.

Shape	Material	Part No.	Ordering No.	Package Quantity	Color Code	
Lens (Round Flush) 	Polyarylate	LW9Z-L1②	LW9Z-L1②PN05	5	Specify a lens color code in place of ② in the Part No. A: amber C: clear G: green R: red S: blue Y: yellow  Note: Use a clear lens for white illumination or for white (LW), PW (pure white), or black (LB) buttons.	
Lens (Round Extended) 	Polyarylate	LW9Z-L12②	LW9Z-L12②PN05	5		
Lens (Square Flush) 	Polyarylate	LW9Z-L2②	LW9Z-L2②PN05	5		
Lens for Pilot Lights (Round Extended) 	Polyarylate	LW9Z-L15②	LW9Z-L15②PN05	5		
Lens for Pilot Lights (Square Extended) 	Polyarylate	LW9Z-L25②	LW9Z-L25②PN05	5		
Illuminated Selector Knob Operator 	AS Plastic	LW9Z-FD6②	LW9Z-FD6②	1		Specify a lens color code in place of ② in the Part No. • A: amber, G: green, R: red, S: blue, W: white, Y: yellow Note: Use W (white) handle for PW (pure white) illumination.
Marking Plate (Round) 	Acrylic	White	LW9Z-P1W	LW9Z-P1WPN05	5	• For round flush pushbuttons, round flush illuminated pushbuttons, and round extended pilot lights. Note: Used for black (LB) button only.
		Black (Note)	LW9Z-P1B	LW9Z-P1BPN05		
Marking Plate (Square) 	Acrylic	White	LW9Z-P2W	LW9Z-P2WPN05	5	• For square flush pushbuttons, square flush illuminated pushbuttons, and square extended pilot lights. Note: Used for black (LB) button only.
		Black	LW9Z-P2B	LW9Z-P2BPN05		
Marking Plate (Round Extended) 	Acrylic	White	LW9Z-P12W	LW9Z-P12WPN05	5	• For round extended pushbuttons and round extended illuminated pushbuttons. Note: Used for black (LB) button only.
		Black	LW9Z-P12B	LW9Z-P12BPN05		
Locking Ring 	Plastic	LW9Z-LN	LW9Z-LNPN05	5	• Black	
Spare Key 	Metal (nickel-plated brass)	LW9Z-SK-500	LW9Z-SK-500PN2	2	• Standard – default key	
		LW9Z-SK-④	LW9Z-SK-④PN02		• Specify a key number 501 to 515 in place of ④ in the Part No.	

LED Lamps

When ordering, specify the Ordering No.

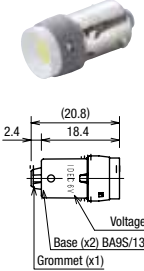
Dimensions	Operating Voltage	Current Draw		Part No.	Ordering No.	Illumination Color Code	Package Quantity	Base		
		AC	DC							
 <p>Base (x2) BA9S/13 Grommet (x1)</p>	6V AC/ DC±10%	8 mA (except S) 7 mA (S)	7 mA (A, R, W) 5.5 mA (G, PW) 4.5 mA (S)	LSTD-6②	LSTD-6②	Specify a color code in place of ② in the Ordering No. A: amber G: green PW: pure white R: red S: blue W: white	1	BA9S/13		
					LSTD-6②PN10		10			
	12V AC/ DC±10%	11 mA (except S) 9 mA (S)	10 mA (except S) 8 mA (S)	LSTD-1②	LSTD-1②		1			
					LSTD-1②PN10		10			
	24V AC/ DC±10%	11 mA (except S) 9 mA (S)	10 mA (except S) 8 mA (S)	LSTD-2②	LSTD-2②		1		Use a pure white (PW) LED lamp with yellow (Y) lens.	1
					LSTD-2②PN10		10			



## Flush Silhouette Switches LW Series

### ⚠ Safety Precautions

- Turn off the power to the flush silhouette LW series control units before installation, removal, wiring, maintenance, and inspection. Failure to turn power off may cause electrical shocks or fire hazard.
- To avoid burning your hand, use the lamp holder tool when replacing lamps.
- For wiring, use wires of a proper size to meet voltage and current requirements.

Solder correctly according to the instructions in "Wiring" and "Notes on Terminal Cover." Tighten the M3.5 terminal screws to a torque of 0.6 to 1.0 N·m. Failure to tighten terminal screws may cause overheating and fire.

## Instructions

### Panel Mounting

#### Removing the Contact Block

Turn the locking lever on the contact block in the direction opposite to the arrow on the housing. Then the contact can be removed.

#### Installing the Contact Block

Insert the contact block, with the TOP markings on the contact block and the operator placed in the same direction. Then lock the units, turning the locking lever in the direction of the arrow.

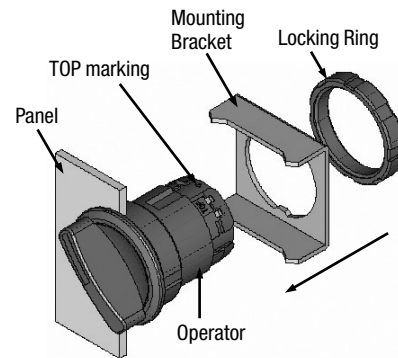
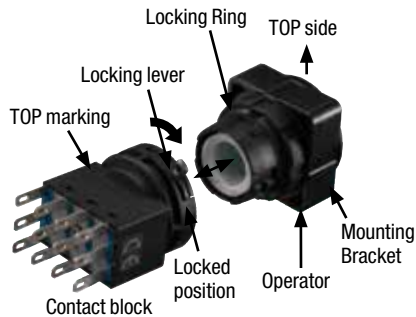

[Selector / Key Selector Switches]

#### Notes on Mounting

Use the optional locking ring wrench (LW9Z-T1) to mount the operator into the panel. Tightening torque should not exceed 1.2 N·m. Do not use pliers. Excessive tightening will damage the locking ring.

#### Collective Mounting

As the locking lever can be turned easily from the rear of the units using a screwdriver, the contact blocks can be removed even when mounted collectively.

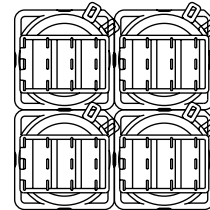

### Panel Mounting

Remove the locking ring and mounting bracket from the operator. Insert the operator into the panel cut-out from the front. With the TOP marking of the operator in the correct direction, insert the mounting bracket from the back of the panel and tighten with a locking nut.

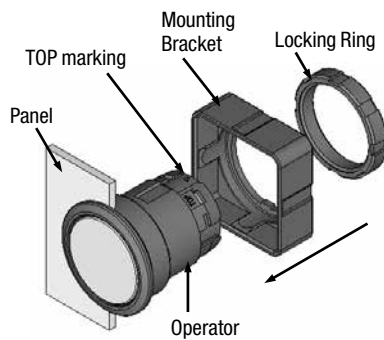

[Round]

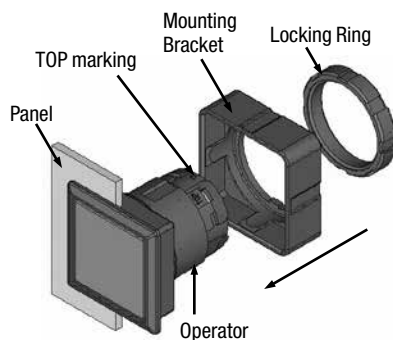

[Square]

APEM

Switches & Pilot Lights

Control Boxes

Emergency Stop Switches

Enabling Switches

Safety Products

Explosion Proof

Terminal Blocks

Relays & Sockets

Circuit Protectors

Power Supplies

LED Illumination

Controllers

Operator Interfaces

Sensors

AUTO-ID

Flush Silhouette

ø16

ø22

ø30

Miniature

Pilot Lights

CW

LW-F

LB

LBW

UP

Flush Bezel

Instructions

Replacement of the Lens and Marking Plate

Removal

1. To remove the lens unit, press the suction cup of the optional lens removal tool (MT-S01) onto the lens and pull the lens unit out.

[Removing the Lens Unit]



2. Remove the marking plate by pushing the lens from the rear to disengage the latches between the lens and the lens holder, using a screwdriver as shown below.

[Removing the Lens]



Note: The translucent filter in the lens holder cannot be removed because the filter is sealed to make the unit waterproof and oiltight.

Installing

1. For round lenses, place the marking plate on the lens holder with the anti-rotation projection engaged and press the lens into the lens holder to engage the latches. For square lenses, insert the marking plate into the lens, and press the lens into the holder to engage the latches.

2. Make sure of the correct orientation of the marking plate.

• Round Lens

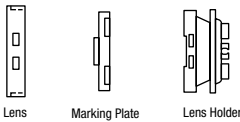

• Square Lens

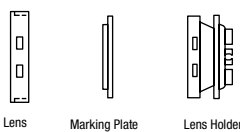

Marking Plate and Film

For LW series illuminated pushbuttons and pilot lights, legends and symbols can be engraved on marking plates, or printed film can be inserted under the lens for labelling purposes.

Marking Plate and Marking Film Size

Lens	Round Lens	Square Lens
Built-in Marking Plate	<ul style="list-style-type: none"> <li>• Engraving must be made on the engraving area within 0.5mm deep.</li> <li>• The marking plate is made of acrylic resin.</li> </ul>	
Applicable Marking Film	<ul style="list-style-type: none"> <li>• Two 0.1mm-thick films or one 0.2mm-thick film can be installed in the lens.</li> <li>• Marking film must be prepared separately.</li> <li>• Recommended marking film: Polyester</li> </ul>	

Insertion Order of Marking Plate and Film

• Round Lens

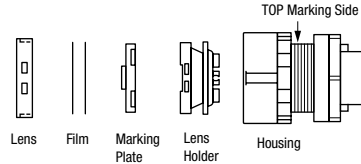

Note: Film must be prepared separately.

• Square Lens

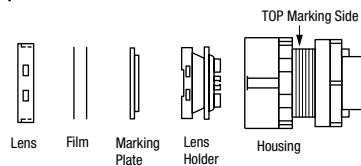

Note: Film must be prepared separately. Make sure of correct orientation of the marking plate.

## Instructions

## Replacement of Lamps

Lamps can be replaced using the lamp holder tool (OR-55) from the front of the panel, or by removing the contact block from the operator.

## Removing the Lamp

To remove, slip the lamp holder tool onto the lamp head. Then push slightly, and turn the lamp holder tool counterclockwise.



## Installing the Lamp

1. To install, insert the lamp head into the lamp holder tool, and hold the lamp as shown in the figure below.



2. Insert the pins on the lamp base into the grooves in the lamp socket. Insert the lamp and turn it clockwise.

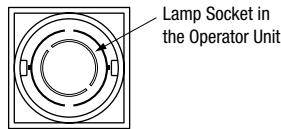

## Installing the Rubber Boot (1\*)

When using in places where the switches are subjected to water splash or an excessive amount of dust, make sure to use the optional rubber boot.

As shown in the drawing below, ① remove the gasket from the operator, and ② attach the rubber boot from the front (button side).

Mount the rubber boot so that the protrusion at the bottom surface of the operator fits with the recess on the operator, placing the rubber boot all around the operator sleeve.

Make sure that the protrusion on the rubber boot and the recess on the operator is properly fitted, otherwise, the waterproof and dustproof characteristics are not ensured.

## How to Install the Rubber Boot

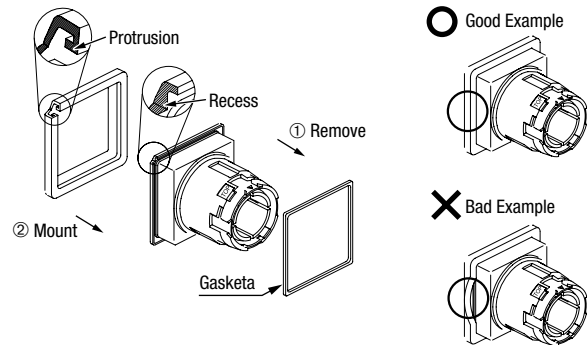

Note: Install the rubber boot before mounting the unit to the panel.

\*1) See **D-062** for details on rubber boot.

## Removing the Illuminated Selector Switch Knob

## Removing the Knob

Insert a flat screwdriver and remove the knob from the operator.

## Installing the Knob

Press the knob into the operator. Align the recess on top end of the knob with the lowest rib on the operator.

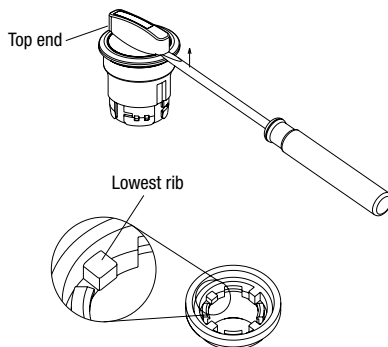

ø16

ø22

ø30

Miniature

Pilot Lights

CW

LW-F

LB

LBW

UP

Flush Bezel

Instructions

Key Selector Switches

- When turning the key, do not pull the key out, otherwise, it may cause damage to the switches.

Pushbuttons/Illuminated Pushbuttons with Guards/  
Switch Guard with Lens

- Do not apply load on the guard in the direction other than the opening/closing the guard. Otherwise the hinge part will be damaged.

Wiring

1. Solder the terminals within 20W/5 sec or 260°C/3 sec without exerting external force to the terminals. While soldering, do not touch the soldering iron to the housing. While wiring, prevent tension from being applied to the terminals. Do not bend or raise the terminals, nor exert excessive force to terminals.
2. Use non-corrosive liquid flux.
3. Positive-lock connector and easylock connectors are applicable to tab terminals.

Terminal	Positive Lock Connector (Tyco Electronics Amp)		Easy Lock Connector (Nichifu)	
	0.2 to 0.5mm <sup>2</sup>	175412-1	0.2 to 0.3mm <sup>2</sup>	OSS-62852F3
0.5 to 1.25mm <sup>2</sup>	174778-1	0.5 to 1.25mm <sup>2</sup>	OSS-62815F3	
Housing	174779-1		NET1-28-1P-V2	

4. Tighten the terminal screw of the screw terminal to a torque of 0.6 to 1.0 N·m.

Notes on Terminal Cover

[Solder/Tab Terminal]

Insert the terminal cover into the contact block with the TOP markings on the contact block and the terminal cover in the same direction.

Note: When wiring, insert the lead wires into the terminal cover holes before soldering.



Notes on Wiring

When installing a terminal cover onto the solder/tab terminal contact block, solder the inside of lamp terminal (toward the switch terminals) and wire.

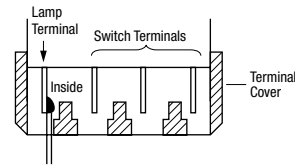

[Screw Terminal]

Install the terminal cover on the control unit before wiring.

Note 1: After wiring, terminal covers cannot be installed.

Note 2: When terminal covers are installed, ring type crimping terminals cannot be used.  
(For wiring, use fork terminals or lead wires directly.)





## Instructions

## Single Board Mounting

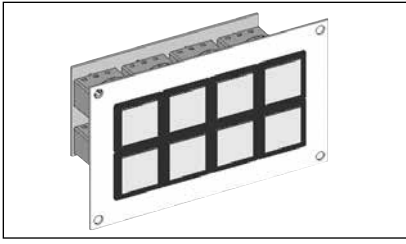

Mounting the control units on a single PC board offers the following features.

1. Reduced installation labor, easy wiring, space saving, and standardization.
2. Since the contact blocks on the PC board can be removed easily using a locking lever, control units are easy to maintain.
3. Because the control units require no studs for fastening the control units to a PC board, special preparation of the panel is not needed.
4. For details on single board mounting, contact IDEC.

## Notes for Designing PC Board and Circuit

- Use 1.6-mm-thick glass epoxy PC board with drilled holes.
- Design a circuit so that the LB/LBW series can operate within the rated voltage and current range. Make sure that inrush current and voltage do not exceed the rating.
- Minimum applicable load is 5V AC/DC, 1 mA on gold contacts. Applicable range is subject to the operating condition and load.
- Since the \*2.8-mm-wide terminal touches the PC board as shown on the right, short circuit may occur with pattern lines. Design a circuit that prevents short circuits.

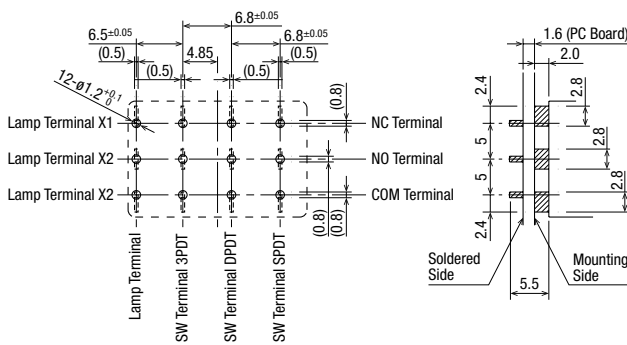

## PC Board Drilling Layout (Bottom View)

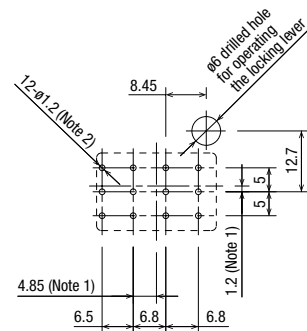

Note 1: When designing, note the alignment of center lines of the contact blocks and center lines of the operators.

Note 2: The diameter of the terminal hole is  $\phi 1.2$ . Hole diameter may vary to meet installation requirements. Determine the location and the size of the hole so that the locking lever can be operated.

## Installing and Removing Contact Blocks

Turn the locking lever to install and remove contact blocks on the PC using a screwdriver from a hole in the PC board. Determine the location of the switches so that the locking lever can be operated.

## Mounting Holes and Assembly Procedure

Drill mounting holes in the panel as shown below. When the units are mounted collectively, provide adequate clearance.

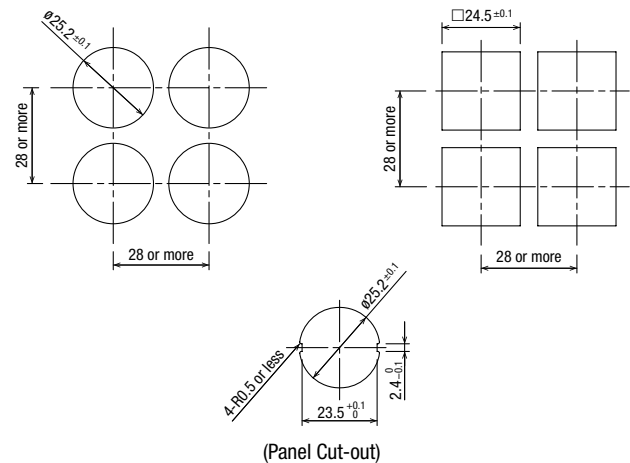

(Panel Cut-out)

## Assembly Procedure

1. Install the operator to the panel.
2. Mount the contact block to the operator from the rear.
3. Turn the locking lever to lock the contact block.
4. Insert the PC board to terminals and solder.

- Make sure that each terminal is inserted into the PC board correctly.
- Do not apply tensile force to the connector cable for an extended period of time.
- Do not expose the contact block to water.
- Ensure to lock contact blocks when the contact blocks are installed on the operators.



APEM

Switches & Pilot Lights

Control Boxes

Emergency Stop Switches

Enabling Switches

Safety Products

Explosion Proof

Terminal Blocks

Relays & Sockets

Circuit Protectors

Power Supplies

LED Illumination

Controllers

Operator Interfaces

Sensors

AUTO-ID

Flush Silhouette

ø16

ø22

ø30

Miniature

Pilot Lights

CW

LW-F

LB

LBW

UP

Flush Bezel

## X-ON Electronics

Largest Supplier of Electrical and Electronic Components

*Click to view similar products for [Control Switches](#) category:*

*Click to view products by [Idec](#) manufacturer:*

Other Similar products are found below :

[80887-99](#) [80932-99](#) [86855-00](#) [88814-30](#) [1424293-1](#) [HW4S-2TC10](#) [89721-12](#) [89804-08](#) [SSN](#) [RL01801](#) [ASD2L20N-LVO](#) [50051857-17](#)  
[50099156-001-05](#) [51.155R-15200](#) [50058920-26](#) [CP-FA51](#) [CP-FA49](#) [ACCU-SC/L-3000](#) [PP9M](#) [PP87G](#) [PP86GA](#) [PP74G](#) [PP73M](#) [PP73G](#)  
[PP71G](#) [PP70G](#) [PP6G](#) [PP62G](#) [PP58BL](#) [PP86GB](#) [PP77GA](#) [PP76G](#) [PP4M](#) [PP47G](#) [PP46G](#) [PP41M](#) [PP40G](#) [PP32G](#) [RD-20](#) [PP23M](#) [PP14M](#)  
[PP12G](#) [PORTAPRO](#) [POM-2708](#) [PNB-2005](#) [3057.0012](#) [CV-075](#) [CV-140SB](#) [CV-150](#) [CV-150S](#)