

## LW Silhouette Series

Bezel projects only 2mm from front of panel!

### Key features:

- PC board mount, solder or screw terminals available.
- Round metallic or plastic bezels are available.
- Collective mounting saves space.
- Pushbuttons, pilot lights, illuminated pushbuttons, selector switches, key selector switches, and illuminated selector switches.
- Square pushbuttons also available with switchguards.
- Key selector switches with high-security lock mechanism.
- Separate contacts with a locking lever enable easy installation even when mounted collectively.
- Gold (gold-clad silver) or silver contacts.
- Degree of protection: IP65 (IEC 60529)
- UL recognized and CSA certified. EN compliant



File No. E55996



File No. 166730 (LR21451)



TÜV Rheinland

### Specifications

<b>Operating Temperature</b>		-25 to +60°C (no freezing), Illuminated units: -25 to +50°C
<b>Storage Temperature</b>		-40 to +80°
<b>Operating Humidity</b>		45 to 85% RH (no condensation)
<b>Contact Resistance</b>		50 mΩ maximum (initial value)
<b>Insulation Resistance</b>		100 MΩ minimum (500V DC megger)
<b>Dielectric Strength</b>	<b>Switch Unit</b>	Between live part and ground: 2,500V AC, 1 minute Between terminals of different poles: 2,500V AC, 1 minute Between terminals of the same poles: 1,000V AC, 1 minute
	<b>Illumination Unit</b>	Between live part and ground: 2,500V AC, 1 minute
<b>Vibration Resistance</b>		Operating extremes: 5 to 55 Hz, amplitude 0.5 mm
<b>Shock Resistance</b>		Damage limits: 1,000 m/s <sup>2</sup> (100G) Operating extremes: 100 m/s <sup>2</sup> (10G)
<b>Mechanical Life (minimum operations)</b>		Momentary: 1,000,000 Maintained: 500,000 Selector switches: 250,000 Key selector switches: 100,000 Illuminated selector switches: 250,000
<b>Electrical Life (minimum operations)</b>		Momentary: 100,000 <sup>1</sup> Maintained: 100,000 <sup>2</sup> Selector switches: 100,000 <sup>2</sup> Key selector switches: 100,000 <sup>2</sup> Illuminated selector switches: 100,000 <sup>2</sup>
<b>Degree of Protection</b>		IP65 (IEC 60529)
<b>Terminal Style</b>		Solder/tab terminal #110 PC board terminal Screw terminal



1. Switching frequency 1,800 operations/hour.
2. Switching frequency 900 operations/hour.

General Specifications

Contact Ratings	Gold Contacts	<b>Maximum Voltage</b>		250V AC/DC			
		<b>Thermal Current</b>		3A			
		<b>Operating Voltage</b>		125V AC	30V DC		
		<b>Operating Current (resistive load)</b>		0.1A	0.1A		
		<b>Contact Material</b>		Gold-clad silver			
	Silver Contacts	<b>Operating Voltage</b>		30V	125V	250V	
		<b>Operating Current</b>	<b>AC 50/60Hz</b>	<b>Resistive Load</b>	–	3A	2A
				<b>Inductive Load</b>	–	2A	1.5A
			<b>DC</b>	<b>Resistive Load</b>	2A	0.4A	–
				<b>Inductive Load</b>	1A	0.2A	–
<b>Thermal Current</b>		5A					
<b>Contact Material</b>		Silver					



- 1. AC inductive load: PF = 0.6 to 0.7
- 2. DC inductive load: L/R = 7 ms max.
- 3. Minimum applicable load (reference value): 5V AC/DC, 1mA



**LED Lamp Ratings (LSTD Type)**

Model No.	LSTD-6②	LSTD-1②	LSTD-2②	LSTD-H2②	LSTD-M4②
Lamp Base	BA9S/13				
Rated Voltage	6V AC/DC	12V AC/DC	24V AC/DC	120V AC	240V AC
Voltage Range	6V AC/DC ±10%	12V AC/DC ±10%	24V AC/DC ±10%	120V AC ±5%	240V AC ±5%
Current Draw	AC	A, R, W, Y: 17mA G, S: 8mA	11mA	11mA	10mA
	DC	A, R, W, Y: 14mA G, S: 5.5mA	10mA	10mA	–
Color Code	A (amber), G (green), R (red), S (blue), W (white), Y (yellow)				
Lamp Base Color	Same as illumination color				
Voltage Marking	Die stamped on the base				
Life (reference value)	Approx. 50,000 hours (The luminance reduces to 50% the initial intensity when used on complete DC.)				
Internal Circuit	A, R, W		A, R, W		
	G, S		G, S		
			<ul style="list-style-type: none"> <li> LED Chip</li> <li> Protection Diode</li> <li> Zener Diode</li> </ul>		

In place of ②, specify the Lens/LED Color Code.

**Part Numbers**

**Non-illuminated Round Pushbuttons with Metal Bezel**

Shape	Operation	Contact Material	Contact	Part Numbers		
				Solder/Tab Terminal	PC Board Terminal	Screw Terminal
Round Flush 	Momentary	Gold	SPDT	LW6MB-M1C1LⓄ	LW6MB-M1C1VLⓄ	—
			DPDT	LW6MB-M1C2LⓄ	LW6MB-M1C2VLⓄ	LW6MB-M1C2MLⓄ
			3PDT	LW6MB-M1C3LⓄ	LW6MB-M1C3VLⓄ	—
		Silver	SPDT	LW6MB-M1C5LⓄ	—	—
			DPDT	LW6MB-M1C6LⓄ	—	LW6MB-M1C6MLⓄ
			3PDT	LW6MB-M1C7LⓄ	—	—
	Maintained	Gold	SPDT	LW6MB-A1C1LⓄ	LW6MB-A1C1VLⓄ	—
			DPDT	LW6MB-A1C2LⓄ	LW6MB-A1C2VLⓄ	LW6MB-A1C2MLⓄ
			3PDT	LW6MB-A1C3LⓄ	LW6MB-A1C3VLⓄ	—
		Silver	SPDT	LW6MB-A1C5LⓄ	—	—
			DPDT	LW6MB-A1C6LⓄ	—	LW6MB-A1C6MLⓄ
			3PDT	LW6MB-A1C7LⓄ	—	—
Round Extended 	Momentary	Gold	SPDT	LW6MB-M2C1LⓄ	LW6MB-M2C1VLⓄ	—
			DPDT	LW6MB-M2C2LⓄ	LW6MB-M2C2VLⓄ	LW6MB-M2C2MLⓄ
			3PDT	LW6MB-M2C3LⓄ	LW6MB-M2C3VLⓄ	—
		Silver	SPDT	LW6MB-M2C5LⓄ	—	—
			DPDT	LW6MB-M2C6LⓄ	—	LW6MB-M2C6MLⓄ
			3PDT	LW6MB-M2C7LⓄ	—	—
	Maintained	Gold	SPDT	LW6MB-A2C1LⓄ	LW6MB-A2C1VLⓄ	—
			DPDT	LW6MB-A2C2LⓄ	LW6MB-A2C2VLⓄ	LW6MB-A2C2MLⓄ
			3PDT	LW6MB-A2C3LⓄ	LW6MB-A2C3VLⓄ	—
		Silver	SPDT	LW6MB-A2C5LⓄ	—	—
			DPDT	LW6MB-A2C6LⓄ	—	LW6MB-A2C6MLⓄ
			3PDT	LW6MB-A2C7LⓄ	—	—

- 1. In place of Ⓞ insert button color from table
- 2. For replacement part numbers see page 666.

**① Button Color Code**

Color	Code
Amber	A
Black	B
Green	G
Red	R
Blue	S
White	W
Yellow	Y

Switches & Pilot Lights

Display Lights

Relays & Sockets

Timers

Terminal Blocks

Circuit Breakers

Non-illuminated Round / Square Pushbuttons with Black Plastic Bezel

Shape	Operation	Contact Material	Contact	Part Numbers		
				Solder/Tab Terminal	PC Board Terminal	Screw Terminal
Round Flush 	Momentary	Gold	SPDT	LW6B-M1C1LⓈ	LW6B-M1C1VLⓈ	–
			DPDT	LW6B-M1C2LⓈ	LW6B-M1C2VLⓈ	LW6B-M1C2MLⓈ
			3PDT	LW6B-M1C3LⓈ	LW6B-M1C3VLⓈ	–
		Silver	SPDT	LW6B-M1C5LⓈ	–	–
			DPDT	LW6B-M1C6LⓈ	–	LW6B-M1C6MLⓈ
			3PDT	LW6B-M1C7LⓈ	–	–
	Maintained	Gold	SPDT	LW6B-A1C1LⓈ	LW6B-A1C1VLⓈ	–
			DPDT	LW6B-A1C2LⓈ	LW6B-A1C2VLⓈ	LW6B-A1C2MLⓈ
			3PDT	LW6B-A1C3LⓈ	LW6B-A1C3VLⓈ	–
		Silver	SPDT	LW6B-A1C5LⓈ	–	–
			DPDT	LW6B-A1C6LⓈ	–	LW6B-A1C6MLⓈ
			3PDT	LW6B-A1C7LⓈ	–	–
Round Extended 	Momentary	Gold	SPDT	LW6B-M2C1LⓈ	LW6B-M2C1VLⓈ	–
			DPDT	LW6B-M2C2LⓈ	LW6B-M2C2VLⓈ	LW6B-M2C2MLⓈ
			3PDT	LW6B-M2C3LⓈ	LW6B-M2C3VLⓈ	–
		Silver	SPDT	LW6B-M2C5LⓈ	–	–
			DPDT	LW6B-M2C6LⓈ	–	LW6B-M2C6MLⓈ
			3PDT	LW6B-M2C7LⓈ	–	–
	Maintained	Gold	SPDT	LW6B-A2C1LⓈ	LW6B-A2C1VLⓈ	–
			DPDT	LW6B-A2C2LⓈ	LW6B-A2C2VLⓈ	LW6B-A2C2MLⓈ
			3PDT	LW6B-A2C3LⓈ	LW6B-A2C3VLⓈ	–
		Silver	SPDT	LW6B-A2C5LⓈ	–	–
			DPDT	LW6B-A2C6LⓈ	–	LW6B-A2C6MLⓈ
			3PDT	LW6B-A2C7LⓈ	–	–
Square Flush 	Momentary	Gold	SPDT	LW7B-M1C1LⓈ	LW7B-M1C1VLⓈ	–
			DPDT	LW7B-M1C2LⓈ	LW7B-M1C2VLⓈ	LW7B-M1C2MLⓈ
			3PDT	LW7B-M1C3LⓈ	LW7B-M1C3VLⓈ	–
		Silver	SPDT	LW7B-M1C5LⓈ	–	–
			DPDT	LW7B-M1C6LⓈ	–	LW7B-M1C6MLⓈ
			3PDT	LW7B-M1C7LⓈ	–	–
	Maintained	Gold	SPDT	LW7B-A1C1LⓈ	LW7B-A1C1VLⓈ	–
			DPDT	LW7B-A1C2LⓈ	LW7B-A1C2VLⓈ	LW7B-A1C2MLⓈ
			3PDT	LW7B-A1C3LⓈ	LW7B-A1C3VLⓈ	–
		Silver	SPDT	LW7B-A1C5LⓈ	–	–
			DPDT	LW7B-A1C6LⓈ	–	LW7B-A1C6MLⓈ
			3PDT	LW7B-A1C7LⓈ	–	–
Square Flush with Guard 	Momentary	Gold	SPDT	LW7GB-M1C1LⓈ	LW7GB-M1C1VLⓈ	–
			DPDT	LW7GB-M1C2LⓈ	LW7GB-M1C2VLⓈ	LW7GB-M1C2MLⓈ
			3PDT	LW7GB-M1C3LⓈ	LW7GB-M1C3VLⓈ	–
		Silver	SPDT	LW7GB-M1C5LⓈ	–	–
			DPDT	LW7GB-M1C6LⓈ	–	LW7GB-M1C6MLⓈ
			3PDT	LW7GB-M1C7LⓈ	–	–
	Maintained	Gold	SPDT	LW7GB-A1C1LⓈ	LW7GB-A1C1VLⓈ	–
			DPDT	LW7GB-A1C2LⓈ	LW7GB-A1C2VLⓈ	LW7GB-A1C2MLⓈ
			3PDT	LW7GB-A1C3LⓈ	LW7GB-A1C3VLⓈ	–
		Silver	SPDT	LW7GB-A1C5LⓈ	–	–
			DPDT	LW7GB-A1C6LⓈ	–	LW7GB-A1C6MLⓈ
			3PDT	LW7GB-A1C7LⓈ	–	–

Ⓢ Button Color Code

Color	Code
Amber	A
Black	B
Green	G
Red	R
Blue	S
White	W
Yellow	Y



1. In place of Ⓢ insert button color from table
2. For replacement part numbers see page 666.

Switches & Pilot Lights

Display Lights

Relays & Sockets

Timers

Terminal Blocks

Circuit Breakers

Switches &amp; Pilot Lights

Display Lights



Relays &amp; Sockets

Timers





Terminal Blocks

Circuit Breakers

**Round / Square Pilot Lights with Metal Bezel**

Shape	Lamp	Part Numbers		
		Solder/Tab Terminal (Unibody Type)	PC Board Terminal (Separate Type)	Screw Terminal (Unibody Type)
Round Flush 	LED	LW6MP-1③②	LW6MP-1C0③V②	LW6MP-1③M②
Round Extended 	LED	LW6MP-2③②	LW6MP-2C0③V②	LW6MP-2③M②

**Round / Square Pilot Lights with Black Plastic Bezel**

Shape	Lamp	Part Numbers		
		Solder/Tab Terminal (Unibody Type)	PC Board Terminal (Separate Type)	Screw Terminal (Unibody Type)
Round Flush 	LED	LW6P-1③②	LW6P-1C0③V②	LW6P-1③M②
Round Extended 	LED	LW6P-2③②	LW6P-2C0③V②	LW6P-2③M②
Square Flush 	LED	LW7P-1③②	LW7P-1C0③V②	LW7P-1③M②
Square Extended 	LED	LW7P-2③②	LW7P-2C0③V②	LW7P-2③M②



Yellow pilot light comes with white LED.

**② Color Code**

Color	Code
Amber	A
Green	G
Red	R
Blue	S
White	W
Yellow	Y

**③ Voltage Code**

Voltage	Code
6V AC/DC	2
12V AC/DC	3
24V AC/DC	4
120V AC	5
240V AC	6



- Every pilot light contains an LED lamp (LSTD) of the specified color and voltage.
- For replacement part numbers see page 666.

**Illuminated Round Pushbuttons with Metal Bezel**

Shape	Lamp	Operation	Contact Material	Contact	Part Numbers		
					Solder/Tab Terminal	PC Board Terminal	Screw Terminal
 Round Flush	LED	Momentary	Gold	SPDT	LW6ML-M1C1③②	LW6ML-M1C1③V②	–
				DPDT	LW6ML-M1C2③②	LW6ML-M1C2③V②	LW6ML-M1C2③M②
				3PDT	LW6ML-M1C3③②	LW6ML-M1C3③V②	–
			Silver	SPDT	LW6ML-M1C5③②	–	–
				DPDT	LW6ML-M1C6③②	–	LW6ML-M1C6③M②
				3PDT	LW6ML-M1C7③②	–	–
		Maintained	Gold	SPDT	LW6ML-A1C1③②	LW6ML-A1C1③V②	–
				DPDT	LW6ML-A1C2③②	LW6ML-A1C2③V②	LW6ML-A1C2③M②
				3PDT	LW6ML-A1C3③②	LW6ML-A1C3③V②	–
			Silver	SPDT	LW6ML-A1C5③②	–	–
				DPDT	LW6ML-A1C6③②	–	LW6ML-A1C6③M②
				3PDT	LW6ML-A1C7③②	–	–
 Round Extended	LED	Momentary	Gold	SPDT	LW6ML-M2C1③②	LW6ML-M2C1③V②	–
				DPDT	LW6ML-M2C2③②	LW6ML-M2C2③V②	LW6ML-M2C2③M②
				3PDT	LW6ML-M2C3③②	LW6ML-M2C3③V②	–
			Silver	SPDT	LW6ML-M2C5③②	–	–
				DPDT	LW6ML-M2C6③②	–	LW6ML-M2C6③M②
				3PDT	LW6ML-M2C7③②	–	–
		Maintained	Gold	SPDT	LW6ML-A2C1③②	LW6ML-A2C1③V②	–
				DPDT	LW6ML-A2C2③②	LW6ML-A2C2③V②	LW6ML-A2C2③M②
				3PDT	LW6ML-A2C3③②	LW6ML-A2C3③V②	–
			Silver	SPDT	LW6ML-A2C5③②	–	–
				DPDT	LW6ML-A2C6③②	–	LW6ML-A2C6③M②
				3PDT	LW6ML-A2C7③②	–	–

② Color Code

Color	Code
Amber	A
Green	G
Red	R
Blue	S
White	W
Yellow	Y

③ Voltage Code

Voltage	Code
6V AC/DC	2
12V AC/DC	3
24V AC/DC	4
120V AC	5
240V AC	6



- In place of ② insert Lens/LED color code from table.
- In place of ③ insert Voltage code from table.
- Every illuminated pushbutton contains an LED lamp (LSTD) of the specified color and voltage.
- For replacement part numbers see page 666.

**Illuminated Round / Square Pushbuttons with Black Plastic Bezel**

Shape	Lamp	Operation	Contact Material	Contact	Part Numbers		
					Solder/Tab Terminal	PC Board Terminal	Screw Terminal
 Round Flush	LED	Momentary	Gold	SPDT	LW6L-M1C1③②	LW6L-M1C1③V②	–
				DPDT	LW6L-M1C2③②	LW6L-M1C2③V②	LW6L-M1C2③M②
				3PDT	LW6L-M1C3③②	LW6L-M1C3③V②	–
			Silver	SPDT	LW6L-M1C5③②	–	–
				DPDT	LW6L-M1C6③②	–	LW6L-M1C6③M②
				3PDT	LW6L-M1C7③②	–	–
		Maintained	Gold	SPDT	LW6L-A1C1③②	LW6L-A1C1③V②	–
				DPDT	LW6L-A1C2③②	LW6L-A1C2③V②	LW6L-A1C2③M②
				3PDT	LW6L-A1C3③②	LW6L-A1C3③V②	–
			Silver	SPDT	LW6L-A1C5③②	–	–
				DPDT	LW6L-A1C6③②	–	LW6L-A1C6③M②
				3PDT	LW6L-A1C7③②	–	–



Yellow pushbutton comes with white LED.

Switches & Pilot Lights

Display Lights

Relays & Sockets

Timers

Terminal Blocks

Circuit Breakers

Shape	Lamp	Operation	Contact Material	Contact	Part Numbers		
					Solder/Tab Terminal	PC Board Terminal	Screw Terminal
Round Extended 	LED	Momentary	Gold	SPDT	LW6L-M2C1③②	LW6L-M2C1③V②	—
				DPDT	LW6L-M2C2③②	LW6L-M2C2③V②	LW6L-M2C2③M②
				3PDT	LW6L-M2C3③②	LW6L-M2C3③V②	—
			Silver	SPDT	LW6L-M2C5③②	—	—
				DPDT	LW6L-M2C6③②	—	LW6L-M2C6③M②
				3PDT	LW6L-M2C7③②	—	—
		Maintained	Gold	SPDT	LW6L-A2C1③②	LW6L-A2C1③V②	—
				DPDT	LW6L-A2C2③②	LW6L-A2C2③V②	LW6L-A2C2③M②
				3PDT	LW6L-A2C3③②	LW6L-A2C3③V②	—
			Silver	SPDT	LW6L-A2C5③②	—	—
				DPDT	LW6L-A2C6③②	—	LW6L-A2C6③M②
				3PDT	LW6L-A2C7③②	—	—
Square Flush 	LED	Momentary	Gold	SPDT	LW7L-M1C1③②	LW7L-M1C1③V②	—
				DPDT	LW7L-M1C2③②	LW7L-M1C2③V②	LW7L-M1C2③M②
				3PDT	LW7L-M1C3③②	LW7L-M1C3③V②	—
			Silver	SPDT	LW7L-M1C5③②	—	—
				DPDT	LW7L-M1C6③②	—	LW7L-M1C6③M②
				3PDT	LW7L-M1C7③②	—	—
		Maintained	Gold	SPDT	LW7L-A1C1③②	LW7L-A1C1③V②	—
				DPDT	LW7L-A1C2③②	LW7L-A1C2③V②	LW7L-A1C2③M②
				3PDT	LW7L-A1C3③②	LW7L-A1C3③V②	—
			Silver	SPDT	LW7L-A1C5③②	—	—
				DPDT	LW7L-A1C6③②	—	LW7L-A1C6③M②
				3PDT	LW7L-A1C7③②	—	—
Square Flush with Switch Guard 	LED	Momentary	Gold	SPDT	LW7GL-M1C1③②	LW7GL-M1C1③V②	—
				DPDT	LW7GL-M1C2③②	LW7GL-M1C2③V②	LW7GL-M1C2③M②
				3PDT	LW7GL-M1C3③②	LW7GL-M1C3③V②	—
			Silver	SPDT	LW7GL-M1C5③②	—	—
				DPDT	LW7GL-M1C6③②	—	LW7GL-M1C6③M②
				3PDT	LW7GL-M1C7③②	—	—
		Maintained	Gold	SPDT	LW7GL-A1C1③②	LW7GL-A1C1③V②	—
				DPDT	LW7GL-A1C2③②	LW7GL-A1C2③V②	LW7GL-A1C2③M②
				3PDT	LW7GL-A1C3③②	LW7GL-A1C3③V②	—
			Silver	SPDT	LW7GL-A1C5③②	—	—
				DPDT	LW7GL-A1C6③②	—	LW7GL-A1C6③M②
				3PDT	LW7GL-A1C7③②	—	—

② Color Code

Color	Code
Amber	A
Green	G
Red	R
Blue	S
White	W
Yellow	Y



③ Voltage Code

Voltage	Code
6V AC/DC	2
12V AC/DC	3
24V AC/DC	4
120V AC	5
240V AC	6



1. In place of ② insert Lens/LED color code from table.
2. In place of ③ insert Voltage code from table.
3. Every illuminated pushbutton contains an LED lamp (LSTD) of the specified color and voltage.
3. For replacement part numbers see page 666.
4. Yellow pushbutton comes with white LED.

Non-illuminated Round Selector Switches with Metal Bezel

Shape	Operatio	Position	Contact Material	Contact	Part Numbers		
					Solder/Tab Terminal	PC Board Terminal	Screw Terminal
Round (Knob Operator) 	90° 2-position Maintained		Gold	SPDT	LW6MS-2C1	LW6MS-2C1V	—
				DPDT	LW6MS-2C2	LW6MS-2C2V	LW6MS-2C2M
				3PDT	LW6MS-2C3	LW6MS-2C3V	—
			Silver	SPDT	LW6MS-2C5	—	—
				DPDT	LW6MS-2C6	—	LW6MS-2C6M
				3PDT	LW6MS-2C7	—	—
	90° 2-position Spring Return from Right		Gold	SPDT	LW6MS-21C1	LW6MS-21C1V	—
				DPDT	LW6MS-21C2	LW6MS-21C2V	LW6MS-21C2M
				3PDT	LW6MS-21C3	LW6MS-21C3V	—
			Silver	SPDT	LW6MS-21C5	—	—
				DPDT	LW6MS-21C6	—	LW6MS-21C6M
				3PDT	LW6MS-21C7	—	—
	45° 3-position Maintained		Gold	DPDT	LW6MS-3C2	LW6MS-3C2V	LW6MS-3C2M
				3PDT	LW6MS-3C3	LW6MS-3C3V	—
				DPDT	LW6MS-3C6	—	LW6MS-3C6M
			Silver	3PDT	LW6MS-3C7	—	—
				DPDT	LW6MS-31C2	LW6MS-31C2V	LW6MS-31C2M
				3PDT	LW6MS-31C3	LW6MS-31C3V	—
	45° 3-position Spring Return from Right		Gold	DPDT	LW6MS-31C6	—	LW6MS-31C6M
				3PDT	LW6MS-31C7	—	—
				DPDT	LW6MS-32C2	LW6MS-32C2V	LW6MS-32C2M
			Silver	3PDT	LW6MS-32C3	LW6MS-32C3V	—
				DPDT	LW6MS-32C6	—	LW6MS-32C6M
				3PDT	LW6MS-32C7	—	—
45° 3-position Spring Return from Left		Gold	DPDT	LW6MS-33C2	LW6MS-33C2V	LW6MS-33C2M	
			3PDT	LW6MS-33C3	LW6MS-33C3V	—	
			DPDT	LW6MS-33C6	—	LW6MS-33C6M	
		Silver	3PDT	LW6MS-33C7	—	—	
			DPDT	LW6MS-33C2	LW6MS-33C2V	LW6MS-33C2M	
			3PDT	LW6MS-33C3	LW6MS-33C3V	—	
45° 3-position Spring Return Two-way		Gold	DPDT	LW6MS-33C6	—	LW6MS-33C6M	
			3PDT	LW6MS-33C7	—	—	
			DPDT	LW6MS-33C2	LW6MS-33C2V	LW6MS-33C2M	
		Silver	3PDT	LW6MS-33C3	LW6MS-33C3V	—	
			DPDT	LW6MS-33C6	—	LW6MS-33C6M	
			3PDT	LW6MS-33C7	—	—	
Round (Lever Operator) 	90° 2-position Maintained		Gold	SPDT	LW6MS-2LC1	LW6MS-2LC1V	—
				DPDT	LW6MS-2LC2	LW6MS-2LC2V	LW6MS-2LC2M
				3PDT	LW6MS-2LC3	LW6MS-2LC3V	—
			Silver	SPDT	LW6MS-2LC5	—	—
				DPDT	LW6MS-2LC6	—	LW6MS-2LC6M
				3PDT	LW6MS-2LC7	—	—
	90° 2-position Spring Return from Right		Gold	SPDT	LW6MS-21LC1	LW6MS-21LC1V	—
				DPDT	LW6MS-21LC2	LW6MS-21LC2V	LW6MS-21LC2M
				3PDT	LW6MS-21LC3	LW6MS-21LC3V	—
			Silver	SPDT	LW6MS-21LC5	—	—
				DPDT	LW6MS-21LC6	—	LW6MS-21LC6M
				3PDT	LW6MS-21LC7	—	—
	45° 3-position Maintained		Gold	DPDT	LW6MS-3LC2	LW6MS-3LC2V	LW6MS-3LC2M
				3PDT	LW6MS-3LC3	LW6MS-3LC3V	—
				DPDT	LW6MS-3LC6	—	LW6MS-3LC6M
			Silver	3PDT	LW6MS-3LC7	—	—
				DPDT	LW6MS-31LC2	LW6MS-31LC2V	LW6MS-31LC2M
				3PDT	LW6MS-31LC3	LW6MS-31LC3V	—
	45° 3-position Spring Return from Right		Gold	DPDT	LW6MS-31LC6	—	LW6MS-31LC6M
				3PDT	LW6MS-31LC7	—	—
				DPDT	LW6MS-32LC2	LW6MS-32LC2V	LW6MS-32LC2M
			Silver	3PDT	LW6MS-32LC3	LW6MS-32LC3V	—
				DPDT	LW6MS-32LC6	—	LW6MS-32LC6M
				3PDT	LW6MS-32LC7	—	—
45° 3-position Spring Return from Left		Gold	DPDT	LW6MS-33LC2	LW6MS-33LC2V	LW6MS-33LC2M	
			3PDT	LW6MS-33LC3	LW6MS-33LC3V	—	
			DPDT	LW6MS-33LC6	—	LW6MS-33LC6M	
		Silver	3PDT	LW6MS-33LC7	—	—	
			DPDT	LW6MS-33LC2	LW6MS-33LC2V	LW6MS-33LC2M	
			3PDT	LW6MS-33LC3	LW6MS-33LC3V	—	
45° 3-position Spring Return Two-way		Gold	DPDT	LW6MS-33LC6	—	LW6MS-33LC6M	
			3PDT	LW6MS-33LC7	—	—	
			DPDT	LW6MS-33LC2	LW6MS-33LC2V	LW6MS-33LC2M	
		Silver	3PDT	LW6MS-33LC3	LW6MS-33LC3V	—	
			DPDT	LW6MS-33LC6	—	LW6MS-33LC6M	
			3PDT	LW6MS-33LC7	—	—	

1. For replacement part numbers see page 666.
2. For contact operation see page 676.

Switches & Pilot Lights

Display Lights

Relays & Sockets















Timers

Terminal Blocks

Circuit Breakers















**Non-illuminated Round Selector Switches with Black Plastic Bezel**

Shape	Operatio	Position	Contact Material	Contact	Part Numbers		
					Solder/Tab Terminal	PC Board Terminal	Screw Terminal
 Round (Knob Operator)	90° 2-position Maintained		Gold	SPDT	LW6S-2C1	LW6S-2C1V	—
				DPDT	LW6S-2C2	LW6S-2C2V	LW6S-2C2M
				3PDT	LW6S-2C3	LW6S-2C3V	—
			Silver	SPDT	LW6S-2C5	—	—
				DPDT	LW6S-2C6	—	LW6S-2C6M
				3PDT	LW6S-2C7	—	—
	90° 2-position Spring Return from Right		Gold	SPDT	LW6S-21C1	LW6S-21C1V	—
				DPDT	LW6S-21C2	LW6S-21C2V	LW6S-21C2M
				3PDT	LW6S-21C3	LW6S-21C3V	—
			Silver	SPDT	LW6S-21C5	—	—
				DPDT	LW6S-21C6	—	LW6S-21C6M
				3PDT	LW6S-21C7	—	—
	45° 3-position Maintained		Gold	DPDT	LW6S-3C2	LW6S-3C2V	LW6S-3C2M
				3PDT	LW6S-3C3	LW6S-3C3V	—
				3PDT	LW6S-3C7	—	—
			Silver	DPDT	LW6S-3C6	—	LW6S-3C6M
				3PDT	LW6S-3C7	—	—
				3PDT	LW6S-3C7	—	—
	45° 3-position Spring Return from Right		Gold	DPDT	LW6S-31C2	LW6S-31C2V	LW6S-31C2M
				3PDT	LW6S-31C3	LW6S-31C3V	—
				3PDT	LW6S-31C7	—	—
			Silver	DPDT	LW6S-31C6	—	LW6S-31C6M
				3PDT	LW6S-31C7	—	—
				3PDT	LW6S-31C7	—	—
45° 3-position Spring Return from Left		Gold	DPDT	LW6S-32C2	LW6S-32C2V	LW6S-32C2M	
			3PDT	LW6S-32C3	LW6S-32C3V	—	
			3PDT	LW6S-32C7	—	—	
		Silver	DPDT	LW6S-32C6	—	LW6S-32C6M	
			3PDT	LW6S-32C7	—	—	
			3PDT	LW6S-32C7	—	—	
45° 3-position Spring Return Two-way		Gold	DPDT	LW6S-33C2	LW6S-33C2V	LW6S-33C2M	
			3PDT	LW6S-33C3	LW6S-33C3V	—	
			3PDT	LW6S-33C7	—	—	
		Silver	DPDT	LW6S-33C6	—	LW6S-33C6M	
			3PDT	LW6S-33C7	—	—	
			3PDT	LW6S-33C7	—	—	
 Round (Lever Operator)	90° 2-position Maintained		Gold	SPDT	LW6S-2LC1	LW6S-2LC1V	—
				DPDT	LW6S-2LC2	LW6S-2LC2V	LW6S-2LC2M
				3PDT	LW6S-2LC3	LW6S-2LC3V	—
			Silver	SPDT	LW6S-2LC5	—	—
				DPDT	LW6S-2LC6	—	LW6S-2LC6M
				3PDT	LW6S-2LC7	—	—
	90° 2-position Spring Return from Right		Gold	SPDT	LW6S-21LC1	LW6S-21LC1V	—
				DPDT	LW6S-21LC2	LW6S-21LC2V	LW6S-21LC2M
				3PDT	LW6S-21LC3	LW6S-21LC3V	—
			Silver	SPDT	LW6S-21LC5	—	—
				DPDT	LW6S-21LC6	—	LW6S-21LC6M
				3PDT	LW6S-21LC7	—	—
	45° 3-position Maintained		Gold	DPDT	LW6S-3LC2	LW6S-3LC2V	LW6S-3LC2M
				3PDT	LW6S-3LC3	LW6S-3LC3V	—
				3PDT	LW6S-3LC7	—	—
			Silver	DPDT	LW6S-3LC6	—	LW6S-3LC6M
				3PDT	LW6S-3LC7	—	—
				3PDT	LW6S-3LC7	—	—
	45° 3-position Spring Return from Right		Gold	DPDT	LW6S-31LC2	LW6S-31LC2V	LW6S-31LC2M
				3PDT	LW6S-31LC3	LW6S-31LC3V	—
				3PDT	LW6S-31LC7	—	—
			Silver	DPDT	LW6S-31LC6	—	LW6S-31LC6M
				3PDT	LW6S-31LC7	—	—
				3PDT	LW6S-31LC7	—	—
45° 3-position Spring Return from Left		Gold	DPDT	LW6S-32LC2	LW6S-32LC2V	LW6S-32LC2M	
			3PDT	LW6S-32LC3	LW6S-32LC3V	—	
			3PDT	LW6S-32LC7	—	—	
		Silver	DPDT	LW6S-32LC6	—	LW6S-32LC6M	
			3PDT	LW6S-32LC7	—	—	
			3PDT	LW6S-32LC7	—	—	
45° 3-position Spring Return Two-way		Gold	DPDT	LW6S-33LC2	LW6S-33LC2V	LW6S-33LC2M	
			3PDT	LW6S-33LC3	LW6S-33LC3V	—	
			3PDT	LW6S-33LC7	—	—	
		Silver	DPDT	LW6S-33LC6	—	LW6S-33LC6M	
			3PDT	LW6S-33LC7	—	—	
			3PDT	LW6S-33LC7	—	—	

1. For replacement part numbers see page 666.
2. For contact operation see page 676.

Non-illuminated Square Selector Switches with Black Plastic Bezel

Shape	Operation	Position	Contact Material	Contact	Part Numbers		
					Solder/Tab Terminal	PC Board Terminal	Screw Terminal
Square (Knob Operator) 	90° 2-position Maintained		Gold	SPDT	LW7S-2C1	LW7S-2C1V	—
				DPDT	LW7S-2C2	LW7S-2C2V	LW7S-2C2M
				3PDT	LW7S-2C3	LW7S-2C3V	—
			Silver	SPDT	LW7S-2C5	—	—
				DPDT	LW7S-2C6	—	LW7S-2C6M
				3PDT	LW7S-2C7	—	—
	90° 2-position Spring Return from Right		Gold	SPDT	LW7S-21C1	LW7S-21C1V	—
				DPDT	LW7S-21C2	LW7S-21C2V	LW7S-21C2M
				3PDT	LW7S-21C3	LW7S-21C3V	—
			Silver	SPDT	LW7S-21C5	—	—
				DPDT	LW7S-21C6	—	LW7S-21C6M
				3PDT	LW7S-21C7	—	—
	45° 3-position Maintained		Gold	DPDT	LW7S-3C2	LW7S-3C2V	LW7S-3C2M
				3PDT	LW7S-3C3	LW7S-3C3V	—
			Silver	DPDT	LW7S-3C6	—	LW7S-3C6M
	45° 3-position Spring Return from Right		Gold	DPDT	LW7S-31C2	LW7S-31C2V	LW7S-31C2M
				3PDT	LW7S-31C3	LW7S-31C3V	—
			Silver	DPDT	LW7S-31C6	—	LW7S-31C6M
	45° 3-position Spring Return from Left		Gold	DPDT	LW7S-32C2	LW7S-32C2V	LW7S-32C2M
				3PDT	LW7S-32C3	LW7S-32C3V	—
			Silver	DPDT	LW7S-32C6	—	LW7S-32C6M
45° 3-position Spring Return Two-way		Gold	DPDT	LW7S-33C2	LW7S-33C2V	LW7S-33C2M	
			3PDT	LW7S-33C3	LW7S-33C3V	—	
		Silver	DPDT	LW7S-33C6	—	LW7S-33C6M	
Square (Lever Operator) 	90° 2-position Maintained		Gold	SPDT	LW7S-2LC1	LW7S-2LC1V	—
				DPDT	LW7S-2LC2	LW7S-2LC2V	LW7S-2LC2M
				3PDT	LW7S-2LC3	LW7S-2LC3V	—
			Silver	SPDT	LW7S-2LC5	—	—
				DPDT	LW7S-2LC6	—	LW7S-2LC6M
				3PDT	LW7S-2LC7	—	—
	90° 2-position Spring Return from Right		Gold	SPDT	LW7S-21LC1	LW7S-21LC1V	—
				DPDT	LW7S-21LC2	LW7S-21LC2V	LW7S-21LC2M
				3PDT	LW7S-21LC3	LW7S-21LC3V	—
			Silver	SPDT	LW7S-21LC5	—	—
				DPDT	LW7S-21LC6	—	LW7S-21LC6M
				3PDT	LW7S-21LC7	—	—
	45° 3-position Maintained		Gold	DPDT	LW7S-3LC2	LW7S-3LC2V	LW7S-3LC2M
				3PDT	LW7S-3LC3	LW7S-3LC3V	—
			Silver	DPDT	LW7S-3LC6	—	LW7S-3LC6M
	45° 3-position Spring Return from Right		Gold	DPDT	LW7S-31LC2	LW7S-31LC2V	LW7S-31LC2M
				3PDT	LW7S-31LC3	LW7S-31LC3V	—
			Silver	DPDT	LW7S-31LC6	—	LW7S-31LC6M
	45° 3-position Spring Return from Left		Gold	DPDT	LW7S-32LC2	LW7S-32LC2V	LW7S-32LC2M
				3PDT	LW7S-32LC3	LW7S-32LC3V	—
			Silver	DPDT	LW7S-32LC6	—	LW7S-32LC6M
45° 3-position Spring Return Two-way		Gold	DPDT	LW7S-33LC2	LW7S-33LC2V	LW7S-33LC2M	
			3PDT	LW7S-33LC3	LW7S-33LC3V	—	
		Silver	DPDT	LW7S-33LC6	—	LW7S-33LC6M	

1. For replacement part numbers see page 666.
2. For contact operation see page 676.

Switches & Pilot Lights

Display Lights











Relays & Sockets

Timers

Terminal Blocks

Circuit Breakers

Round Key Selector Switches with Metal Bezel (2-Position and 3-Position)

Shape	Operation	Position	Key Retained at ●	Contact Material	Contact	Part Numbers					
						Solder/Tab Terminal	PC Board Terminal	Screw Terminal			
Round 	90° 2-position Maintained	A		Gold	SPDT	LW6MK-2C1A	LW6MK-2C1VA	—			
					DPDT	LW6MK-2C2A	LW6MK-2C2VA	LW6MK-2C2MA			
					3PDT	LW6MK-2C3A	LW6MK-2C3VA	—			
				Silver	SPDT	LW6MK-2C5A	—	—			
					DPDT	LW6MK-2C6A	—	LW6MK-2C6MA			
					3PDT	LW6MK-2C7A	—	—			
		B	Gold	SPDT	LW6MK-2C1B	LW6MK-2C1VB	—				
				DPDT	LW6MK-2C2B	LW6MK-2C2VB	LW6MK-2C2MB				
				3PDT	LW6MK-2C3B	LW6MK-2C3VB	—				
			Silver	SPDT	LW6MK-2C5B	—	—				
				DPDT	LW6MK-2C6B	—	LW6MK-2C6MB				
				3PDT	LW6MK-2C7B	—	—				
	90° 2-position Spring Return from Right	B		Gold	SPDT	LW6MK-2C1C	LW6MK-2C1VC	—			
					DPDT	LW6MK-2C2C	LW6MK-2C2VC	LW6MK-2C2MC			
					3PDT	LW6MK-2C3C	LW6MK-2C3VC	—			
				Silver	SPDT	LW6MK-2C5C	—	—			
					DPDT	LW6MK-2C6C	—	LW6MK-2C6MC			
					3PDT	LW6MK-2C7C	—	—			
				45° 3-position Maintained	A		Gold	SPDT	LW6MK-21C1B	LW6MK-21C1VB	—
								DPDT	LW6MK-21C2B	LW6MK-21C2VB	LW6MK-21C2MB
								3PDT	LW6MK-21C3B	LW6MK-21C3VB	—
	Silver	SPDT	LW6MK-21C5B				—	—			
		DPDT	LW6MK-21C6B				—	LW6MK-21C6MB			
		3PDT	LW6MK-21C7B				—	—			
B		Gold	DPDT		LW6MK-3C2A	LW6MK-3C2VA	LW6MK-3C2MA				
			3PDT		LW6MK-3C3A	LW6MK-3C3VA	—				
			Silver		DPDT	LW6MK-3C6A	—	LW6MK-3C6MA			
		Silver	3PDT		LW6MK-3C7A	—	—				
			Gold		DPDT	LW6MK-3C2B	LW6MK-3C2VB	LW6MK-3C2MB			
					3PDT	LW6MK-3C3B	LW6MK-3C3VB	—			
Silver	DPDT	LW6MK-3C6B			—	LW6MK-3C6MB					
	Silver	3PDT	LW6MK-3C7B		—	—					
		C			Gold	DPDT	LW6MK-3C2C	LW6MK-3C2VC	LW6MK-3C2MC		
3PDT						LW6MK-3C3C	LW6MK-3C3VC	—			
Silver	DPDT					LW6MK-3C6C	—	LW6MK-3C6MC			
Silver	3PDT				LW6MK-3C7C	—	—				
	D				Gold	DPDT	LW6MK-3C2D	LW6MK-3C2VD	LW6MK-3C2MD		
						3PDT	LW6MK-3C3D	LW6MK-3C3VD	—		
Silver		DPDT	LW6MK-3C6D			—	LW6MK-3C6MD				
Silver		3PDT	LW6MK-3C7D		—	—					
		E			Gold	DPDT	LW6MK-3C2E	LW6MK-3C2VE	LW6MK-3C2ME		
						3PDT	LW6MK-3C3E	LW6MK-3C3VE	—		
Silver	DPDT			LW6MK-3C6E		—	LW6MK-3C6ME				
Silver	3PDT			LW6MK-3C7E	—	—					
	G				Gold	DPDT	LW6MK-3C2G	LW6MK-3C2VG	LW6MK-3C2MG		
						3PDT	LW6MK-3C3G	LW6MK-3C3VG	—		
Silver		DPDT	LW6MK-3C6G			—	LW6MK-3C6MG				
Silver		3PDT	LW6MK-3C7G		—	—					
		H			Gold	DPDT	LW6MK-3C2H	LW6MK-3C2VH	LW6MK-3C2MH		
						3PDT	LW6MK-3C3H	LW6MK-3C3VH	—		
Silver	DPDT			LW6MK-3C6H		—	LW6MK-3C6MH				
Silver	3PDT			LW6MK-3C7H	—	—					

\*Key is retained in ● and removable in ○ position.

Switches & Pilot Lights  
Display Lights  
Relays & Sockets  
Timers  
Terminal Blocks  
Circuit Breakers

Shape	Operation	Position	Key Retained at ●	Contact Material	Contact	Part Numbers		
						Solder/Tab Terminal	PC Board Terminal	Screw Terminal
 <p>Round</p>	45° 3-position Spring Return from Right	B		Gold	DPDT	LW6MK-31C2B	LW6MK-31C2VB	LW6MK-31C2MB
					3PDT	LW6MK-31C3B	LW6MK-31C3VB	—
				Silver	DPDT	LW6MK-31C6B	—	LW6MK-31C6MB
					3PDT	LW6MK-31C7B	—	—
		D	Gold	DPDT	LW6MK-31C2D	LW6MK-31C2VD	LW6MK-31C2MD	
				3PDT	LW6MK-31C3D	LW6MK-31C3VD	—	
			Silver	DPDT	LW6MK-31C6D	—	LW6MK-31C6MD	
				3PDT	LW6MK-31C7D	—	—	
		G	Gold	DPDT	LW6MK-31C2G	LW6MK-31C2VG	LW6MK-31C2MG	
				3PDT	LW6MK-31C3G	LW6MK-31C3VG	—	
			Silver	DPDT	LW6MK-31C6G	—	LW6MK-31C6MG	
				3PDT	LW6MK-31C7G	—	—	
	45° 3-position Spring Return from Left	C		Gold	DPDT	LW6MK-32C2C	LW6MK-32C2VC	LW6MK-32C2MC
					3PDT	LW6MK-32C3C	LW6MK-32C3VC	—
				Silver	DPDT	LW6MK-32C6C	—	LW6MK-32C6MC
					3PDT	LW6MK-32C7C	—	—
		D	Gold	DPDT	LW6MK-32C2D	LW6MK-32C2VD	LW6MK-32C2MD	
				3PDT	LW6MK-32C3D	LW6MK-32C3VD	—	
			Silver	DPDT	LW6MK-32C6D	—	LW6MK-32C6MD	
				3PDT	LW6MK-32C7D	—	—	
		H	Gold	DPDT	LW6MK-32C2H	LW6MK-32C2VH	LW6MK-32C2MH	
				3PDT	LW6MK-32C3H	LW6MK-32C3VH	—	
			Silver	DPDT	LW6MK-32C6H	—	LW6MK-32C6MH	
				3PDT	LW6MK-32C7H	—	—	
45° 3-position Spring Return Two-way	D		Gold	DPDT	LW6MK-33C2D	LW6MK-33C2VD	LW6MK-33C2MD	
				3PDT	LW6MK-33C3D	LW6MK-33C3VD	—	
			Silver	DPDT	LW6MK-33C6D	—	LW6MK-33C6MD	
				3PDT	LW6MK-33C7D	—	—	



1. Key is retained in ● position and removable in ○ position.
2. Two keys are supplied.
3. Key cylinder face material: Metal
4. To select different key numbers, specify numbers from 501 to 515 after the part number. When a key number is not specified, key number 500 is supplied as the default key.  
Example: LW6MK-2C1A-501  
500 (default key) to 515
5. For replacement part numbers see page 666.
6. For Contact Operation chart see page 676.

Switches & Pilot Lights

Display Lights









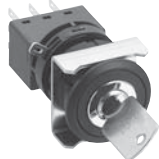

Relays & Sockets

Timers

Terminal Blocks

Circuit Breakers

Key Selector Switches with Black Plastic Bezel (2-Position and 3-Position)

Shape	Operation	Position	Key Retained at ●	Contact Material	Contact	Part Numbers		
						Solder/Tab Terminal	PC Board Terminal	Screw Terminal
Round 	90° 2-position Maintained	A		Gold	SPDT	LW6K-2C1A	LW6K-2C1VA	—
					DPDT	LW6K-2C2A	LW6K-2C2VA	LW6K-2C2A
					3PDT	LW6K-2C3A	LW6K-2C3VA	—
				Silver	SPDT	LW6K-2C5A	—	—
					DPDT	LW6K-2C6A	—	LW6K-2C6A
					3PDT	LW6K-2C7A	—	—
		B	Gold	SPDT	LW6K-2C1B	LW6K-2C1VB	—	
				DPDT	LW6K-2C2B	LW6K-2C2VB	LW6K-2C2B	
				3PDT	LW6K-2C3B	LW6K-2C3VB	—	
			Silver	SPDT	LW6K-2C5B	—	—	
				DPDT	LW6K-2C6B	—	LW6K-2C6B	
				3PDT	LW6K-2C7B	—	—	
	C	Gold		SPDT	LW6K-2C1C	LW6K-2C1VC	—	
				DPDT	LW6K-2C2C	LW6K-2C2VC	LW6K-2C2C	
				3PDT	LW6K-2C3C	LW6K-2C3VC	—	
		Silver	SPDT	LW6K-2C5C	—	—		
			DPDT	LW6K-2C6C	—	LW6K-2C6C		
			3PDT	LW6K-2C7C	—	—		
	90° 2-position Spring Return from Right	B		Gold	SPDT	LW6K-21C1B	LW6K-21C1VB	—
					DPDT	LW6K-21C2B	LW6K-21C2VB	LW6K-21C2B
					3PDT	LW6K-21C3B	LW6K-21C3VB	—
				Silver	SPDT	LW6K-21C5B	—	—
					DPDT	LW6K-21C6B	—	LW6K-21C6B
					3PDT	LW6K-21C7B	—	—
45° 3-position Maintained	A		Gold	DPDT	LW6K-3C2A	LW6K-3C2VA	LW6K-3C2A	
				3PDT	LW6K-3C3A	LW6K-3C3VA	—	
				Silver	DPDT	LW6K-3C6A	—	LW6K-3C6A
			Silver	3PDT	LW6K-3C7A	—	—	
				Gold	DPDT	LW6K-3C2B	LW6K-3C2VB	LW6K-3C2B
					3PDT	LW6K-3C3B	LW6K-3C3VB	—
	Silver	DPDT	LW6K-3C6B		—	LW6K-3C6B		
		3PDT	LW6K-3C7B	—	—			
		C	Gold		DPDT	LW6K-3C2C	LW6K-3C2VC	LW6K-3C2C
	3PDT				LW6K-3C3C	LW6K-3C3VC	—	
	Silver				DPDT	LW6K-3C6C	—	LW6K-3C6C
	Silver		3PDT	LW6K-3C7C	—	—		
			Gold		DPDT	LW6K-3C2D	LW6K-3C2VD	LW6K-3C2D
					3PDT	LW6K-3C3D	LW6K-3C3VD	—
	Silver	DPDT			LW6K-3C6D	—	LW6K-3C6D	
		3PDT	LW6K-3C7D	—	—			
		E	Gold		DPDT	LW6K-3C2E	LW6K-3C2VE	LW6K-3C2E
	3PDT				LW6K-3C3E	LW6K-3C3VE	—	
	Silver				DPDT	LW6K-3C6E	—	LW6K-3C6E
			3PDT	LW6K-3C7E	—	—		
			G	Gold		DPDT	LW6K-3C2G	LW6K-3C2VG
	3PDT					LW6K-3C3G	LW6K-3C3VG	—
	Silver	DPDT				LW6K-3C6G	—	LW6K-3C6G
		3PDT		LW6K-3C7G	—	—		
H		Gold			DPDT	LW6K-3C2H	LW6K-3C2VH	LW6K-3C2H
	3PDT				LW6K-3C3H	LW6K-3C3VH	—	
	Silver		DPDT		LW6K-3C6H	—	LW6K-3C6H	
		3PDT	LW6K-3C7H	—	—			

\*Key is retained in ● and removable in ○ position.

Switches & Pilot Lights  
Display Lights  
Relays & Sockets  
Timers  
Terminal Blocks  
Circuit Breakers

Shape	Operation	Position	Key Retained at ●	Contact Material	Contact	Part Numbers		
						Solder/Tab Terminal	PC Board Terminal	Screw Terminal
 Round	45° 3-position Spring Return from Right	B		Gold	DPDT	LW6K-31C2B	LW6K-31C2VB	LW6K-31C2B
					3PDT	LW6K-31C3B	LW6K-31C3VB	—
				Silver	DPDT	LW6K-31C6B	—	LW6K-31C6B
					3PDT	LW6K-31C7B	—	—
		D	Gold	DPDT	LW6K-31C2D	LW6K-31C2VD	LW6K-31C2D	
				3PDT	LW6K-31C3D	LW6K-31C3VD	—	
			Silver	DPDT	LW6K-31C6D	—	LW6K-31C6D	
				3PDT	LW6K-31C7D	—	—	
		G	Gold	DPDT	LW6K-31C2G	LW6K-31C2VG	LW6K-31C2G	
				3PDT	LW6K-31C3G	LW6K-31C3VG	—	
			Silver	DPDT	LW6K-31C6G	—	LW6K-31C6G	
				3PDT	LW6K-31C7G	—	—	
	45° 3-position Spring Return from Left	C		Gold	DPDT	LW6K-32C2C	LW6K-32C2VC	LW6K-32C2C
					3PDT	LW6K-32C3C	LW6K-32C3VC	—
				Silver	DPDT	LW6K-32C6C	—	LW6K-32C6C
					3PDT	LW6K-32C7C	—	—
		D	Gold	DPDT	LW6K-32C2D	LW6K-32C2VD	LW6K-32C2D	
				3PDT	LW6K-32C3D	LW6K-32C3VD	—	
			Silver	DPDT	LW6K-32C6D	—	LW6K-32C6D	
				3PDT	LW6K-32C7D	—	—	
		H	Gold	DPDT	LW6K-32C2H	LW6K-32C2VH	LW6K-32C2H	
				3PDT	LW6K-32C3H	LW6K-32C3VH	—	
			Silver	DPDT	LW6K-32C6H	—	LW6K-32C6H	
				3PDT	LW6K-32C7H	—	—	
45° 3-position Spring Return Two-way	D		Gold	DPDT	LW6K-33C2D	LW6K-33C2VD	LW6K-33C2D	
				3PDT	LW6K-33C3D	LW6K-33C3VD	—	
			Silver	DPDT	LW6K-33C6D	—	LW6K-33C6D	
				3PDT	LW6K-33C7D	—	—	



- Key is retained in ● position and removable in ○ position.
- Two keys are supplied.
- Key cylinder face: Metal
- To select different key numbers, specify numbers from 501 to 515 after the part number. When a key number is not specified, key number 500 is supplied as the default key.  
Example: LW6MK-2C1A-501
- 500 (default key) to 515
- For replacement part numbers see page 666.
- For Contact Operation chart see page 676.

Switches & Pilot Lights

Display Lights

Relays & Sockets

Timers

Terminal Blocks

Circuit Breakers

**Illuminated Round Selector Switches with Metal or Black Plastic Bezel**

Shape	Operation	Position	Contact Material	Contact	Part Numbers		
					Solder/Tab Terminal	PC Board Terminal	Screw Terminal
Round (Knob Operator)	90° 2-position Maintained		Gold	SPDT	LW6MF-2C1③②	LW6MF-2C1③V②	—
				DPDT	LW6MF-2C2③②	LW6MF-2C2③V②	LW6MF-2C2③M②
				3PDT	LW6MF-2C3③②	LW6MF-2C3③V②	—
			Silver	SPDT	LW6MF-2C5③②	—	—
				DPDT	LW6MF-2C6③②	—	LW6MF-2C6③M②
				3PDT	LW6MF-2C7③②	—	—
	90° 2-position spring Return from Right		Gold	SPDT	LW6MF-21C1③②	LW6MF-21C1③V②	—
				DPDT	LW6MF-21C2③②	LW6MF-21C2③V②	LW6MF-21C2③M②
				3PDT	LW6MF-21C3③②	LW6MF-21C3③V②	—
			Silver	SPDT	LW6MF-21C5③②	—	—
				DPDT	LW6MF-21C6③②	—	LW6MF-21C6③M②
				3PDT	LW6MF-21C7③②	—	—
	45° 3-position Maintained		Gold	DPDT	LW6MF-3C2③②	LW6MF-3C2③V②	LW6MF-3C2③M②
				3PDT	LW6MF-3C3③②	LW6MF-3C3③V②	—
			Silver	DPDT	LW6MF-3C6③②	—	LW6MF-3C6③M②
	45° 3-position spring Return from Right		Gold	DPDT	LW6MF-31C2③②	LW6MF-31C2③V②	LW6MF-31C2③M②
				3PDT	LW6MF-31C3③②	LW6MF-31C3③V②	—
			Silver	DPDT	LW6MF-31C6③②	—	LW6MF-31C6③M②
45° 3-position spring Return from Left		Gold	DPDT	LW6MF-32C2③②	LW6MF-32C2③V②	LW6MF-32C2③M②	
			3PDT	LW6MF-32C3③②	LW6MF-32C3③V②	—	
		Silver	DPDT	LW6MF-32C6③②	—	LW6MF-32C6③M②	
45° 3-position spring Return Two-way		Gold	DPDT	LW6MF-33C2③②	LW6MF-33C2③V②	LW6MF-33C2③M②	
			3PDT	LW6MF-33C3③②	LW6MF-33C3③V②	—	
		Silver	DPDT	LW6MF-33C6③②	—	LW6MF-33C6③M②	
Round (Knob Operator)	90° 2-position Maintained		Gold	SPDT	LW6F-2C1③②	LW6F-2C1③V②	—
				DPDT	LW6F-2C2③②	LW6F-2C2③V②	LW6F-2C2③M②
				3PDT	LW6F-2C3③②	LW6F-2C3③V②	—
			Silver	SPDT	LW6F-2C5③②	—	—
				DPDT	LW6F-2C6③②	—	LW6F-2C6③M②
				3PDT	LW6F-2C7③②	—	—
	90° 2-position Spring Return from Right		Gold	SPDT	LW6F-21C1③②	LW6F-21C1③V②	—
				DPDT	LW6F-21C2③②	LW6F-21C2③V②	LW6F-21C2③M②
				3PDT	LW6F-21C3③②	LW6F-21C3③V②	—
			Silver	SPDT	LW6F-21C5③②	—	—
				DPDT	LW6F-21C6③②	—	LW6F-21C6③M②
				3PDT	LW6F-21C7③②	—	—
	45° 3-position Maintained		Gold	DPDT	LW6F-3C2③②	LW6F-3C2③V②	LW6F-3C2③M②
				3PDT	LW6F-3C3③②	LW6F-3C3③V②	—
			Silver	DPDT	LW6F-3C6③②	—	LW6F-3C6③M②
	45° 3-position Spring Return from Right		Gold	DPDT	LW6F-31C2③②	LW6F-31C2③V②	LW6F-31C2③M②
				3PDT	LW6F-31C3③②	LW6F-31C3③V②	—
			Silver	DPDT	LW6F-31C6③②	—	LW6F-31C6③M②
45° 3-position Spring Return from Left		Gold	DPDT	LW6F-32C2③②	LW6F-32C2③V②	LW6F-32C2③M②	
			3PDT	LW6F-32C3③②	LW6F-32C3③V②	—	
		Silver	DPDT	LW6F-32C6③②	—	LW6F-32C6③M②	
45° 3-position Spring Return Two-way		Gold	DPDT	LW6F-33C2③②	LW6F-33C2③V②	LW6F-33C2③M②	
			3PDT	LW6F-33C3③②	LW6F-33C3③V②	—	
		Silver	DPDT	LW6F-33C6③②	—	LW6F-33C6③M②	
				SPDT	LW6F-33C7③②	—	—

② **Color Code**

Color	Code
Amber	A
Green	G
Red	R
Blue	S
White	W
Yellow	Y

③ **Voltage Code**

Voltage	Code
6V AC/DC	2
12V AC/DC	3
24V AC/DC	4
120V AC	5
240V AC	6



- In place of ③ insert Lens/LED color code from table.
- In place of ③ insert Voltage code from table.
- Every illuminated selector switch contains an LED lamp (LSTD) of the specified color and voltage.
- For replacement part numbers see page 666.
- For Contact Operation chart see page 676.
- Yellow selector switch comes with white LED.

Switches & Pilot Lights

Display Lights

Relays & Sockets

Timers

Terminal Blocks

Circuit Breakers

Round  
(Knob Operator)



Round  
(Knob Operator)



Illuminated Square Selector Switches with Black Plastic Bezel

Shape	Operation	Position	Contact Material	Contact	Part Numbers			
					Solder/Tab Terminal	PC Board Terminal	Screw Terminal	
Square (Knob Operator) 	90° 2-position Maintained		Gold	SPDT	LW7F-2C1 <sup>③</sup> ②	LW7F-2C1 <sup>③</sup> V②	—	
				DPDT	LW7F-2C2 <sup>③</sup> ②	LW7F-2C2 <sup>③</sup> V②	LW7F-2C2 <sup>③</sup> M②	
				3PDT	LW7F-2C3 <sup>③</sup> ②	LW7F-2C3 <sup>③</sup> V②	—	
			Silver	SPDT	LW7F-2C5 <sup>③</sup> ②	—	—	
				DPDT	LW7F-2C6 <sup>③</sup> ②	—	LW7F-2C6 <sup>③</sup> M②	
				3PDT	LW7F-2C7 <sup>③</sup> ②	—	—	
	90° 2-position Spring Return from Right		Gold	SPDT	LW7F-21C1 <sup>③</sup> ②	LW7F-21C1 <sup>③</sup> V②	—	
				DPDT	LW7F-21C2 <sup>③</sup> ②	LW7F-21C2 <sup>③</sup> V②	LW7F-21C2 <sup>③</sup> M②	
				3PDT	LW7F-21C3 <sup>③</sup> ②	LW7F-21C3 <sup>③</sup> V②	—	
			Silver	SPDT	LW7F-21C5 <sup>③</sup> ②	—	—	
				DPDT	LW7F-21C6 <sup>③</sup> ②	—	LW7F-21C6 <sup>③</sup> M②	
				3PDT	LW7F-21C7 <sup>③</sup> ②	—	—	
	45° 3-position Maintained		Gold	DPDT	LW7F-3C2 <sup>③</sup> ②	LW7F-3C2 <sup>③</sup> V②	LW7F-3C2 <sup>③</sup> M②	
				3PDT	LW7F-3C3 <sup>③</sup> ②	LW7F-3C3 <sup>③</sup> V②	—	
				Silver	DPDT	LW7F-3C6 <sup>③</sup> ②	—	LW7F-3C6 <sup>③</sup> M②
			Silver	3PDT	LW7F-3C7 <sup>③</sup> ②	—	—	
				Gold	DPDT	LW7F-31C2 <sup>③</sup> ②	LW7F-31C2 <sup>③</sup> V②	LW7F-31C2 <sup>③</sup> M②
					3PDT	LW7F-31C3 <sup>③</sup> ②	LW7F-31C3 <sup>③</sup> V②	—
	Silver	DPDT	LW7F-31C6 <sup>③</sup> ②		—	LW7F-31C6 <sup>③</sup> M②		
		Gold	DPDT	LW7F-32C2 <sup>③</sup> ②	LW7F-32C2 <sup>③</sup> V②	LW7F-32C2 <sup>③</sup> M②		
			3PDT	LW7F-32C3 <sup>③</sup> ②	LW7F-32C3 <sup>③</sup> V②	—		
	Silver		DPDT	LW7F-32C6 <sup>③</sup> ②	—	LW7F-32C6 <sup>③</sup> M②		
		Gold	DPDT	LW7F-33C2 <sup>③</sup> ②	LW7F-33C2 <sup>③</sup> V②	LW7F-33C2 <sup>③</sup> M②		
			3PDT	LW7F-33C3 <sup>③</sup> ②	LW7F-33C3 <sup>③</sup> V②	—		
Silver	DPDT		LW7F-33C6 <sup>③</sup> ②	—	LW7F-33C6 <sup>③</sup> M②			
	3PDT	LW7F-33C7 <sup>③</sup> ②	—	—				

② Color Code

Color	Code
Amber	A
Green	G
Red	R
Blue	S
White	W
Yellow	Y

③ Voltage Code

Voltage	Code
6V AC/DC	2
12V AC/DC	3
24V AC/DC	4
120V AC	5
240V AC	6



1. In place of ② insert Lens/LED color code from table.
2. In place of ③ insert Voltage code from table.
3. Every illuminated selector switch contains an LED lamp (LSTD) of the specified color and voltage.
4. For replacement part numbers see page 666.
5. For Contact Operation chart see page 676.
6. Yellow selector switch comes with white LED.

Switches & Pilot Lights

Display Lights

Relays & Sockets

Timers

Terminal Blocks

Circuit Breakers



## Replacement Parts Operators

### Pilot Lights

Shape	Terminals	Part Number
Round	Solder Tab	LW6ⓄP-00
	Screw	LW6ⓄP-00M
	PC Board	LW6ⓄP-0
Square	Solder Tab	LW7P-00
	Screw	LW7P-00M
	PC Board	LW7P-0



In place of Ⓞ insert Bezel Code.

### Non-illuminated & Illuminated Pushbuttons

Shape	Function	Part Number
Round	Maintained	LW6ⓄL-A0
	Momentary	LW6ⓄL-M0
Square	Maintained	LW7L-A0
	Momentary	LW7L-M0
Square with Guard	Maintained	LW7GL-A0
	Momentary	LW7GL-M0



In place of Ⓞ insert Bezel Code.

### Non-illuminated Selector Switches

Position	Shape	Function	Handle	Part Number		
2-Position	Round	Maintained	Knob	LW6ⓄS-2Y		
			Lever	LW6ⓄS-2L		
		Spring Return from Right	Knob	LW6ⓄS-21Y		
	Lever		LW6ⓄS-21L			
	3-Position	Square	Maintained	Knob	LW7S-2Y	
				Lever	LW7S-2L	
Spring Return from Right			Knob	LW7S-21Y		
			Lever	LW7S-21L		
3-Position			Round	Maintained	Knob	LW6ⓄS-3Y
					Lever	LW6ⓄS-3L
	Spring Return from Right	Knob		LW6ⓄS-31Y		
		Lever		LW6ⓄS-31L		
	Spring Return from Left	Knob		LW6ⓄS-32Y		
		Lever		LW6ⓄS-32L		
Two-way Spring Return	Knob	LW6ⓄS-33Y				
	Lever	LW6ⓄS-33L				
3-Position	Square	Maintained	Knob	LW7S-3Y		
			Lever	LW7S-3L		
		Spring Return from Right	Knob	LW7S-31Y		
			Lever	LW7S-31L		
		Spring Return from Left	Knob	LW7S-32Y		
			Lever	LW7S-32L		
		Two-way Spring Return	Knob	LW7S-33Y		
			Lever	LW7S-33L		

### Ⓞ Bezel Code

	Code
blank	Black Plastic Bezel
M	Metal Bezel



In place of Ⓞ insert Bezel Code.

**Illuminated Selector Switches**

Position	Shape	Function	Part Number
2-Position	Round	Maintained	LW6ⓄF-20
		Spring Return from Right	LW6ⓄF-210
	Square	Maintained	LW7F-20
		Spring Return from Right	LW7F-210
3-Position	Round	Maintained	LW6ⓄF-30
		Spring Return from Right	LW6ⓄF-310
		Spring Return from Left	LW6ⓄF-320
		Two-way Spring Return	LW6ⓄF-330
	Square	Maintained	LW7F-30
		Spring Return from Right	LW7F-310
		Spring Return from Left	LW7F-320
		Two-way Spring Return	LW7F-330

In place of Ⓞ insert Bezel Code.

**Key Selector Switches**

Position	Shape	Function	Part Number
2-Position	Round	Maintained	LW6ⓄK-2
		Spring Return from Right	LW6ⓄK-21
3-Position	Round	Maintained	LW6ⓄK-3Ⓞ
		Spring Return from Right	LW6ⓄK-31Ⓞ
		Spring Return from Left	LW6ⓄK-32Ⓞ
		Two-way Spring Return	LW6ⓄK-33Ⓞ

1. In place of Ⓞ insert Bezel Code.  
2. In place of Ⓞ insert Key Removable Option Code.







**Ⓞ Bezel Code**

Code	Description
blank	Black Plastic Bezel
M	Metal Bezel

**Ⓞ Key Removable Option Codes**



Code	Description
A	Key not retained in any position (removable in all positions)
B	Key retained in right position only
C	Key retained in left position only
D	Key retained in left and right (3 position only)
E	Key retained in center only (3 position only)
G	Key retained right and center (3 position only)
H	Key retained left and center (3 position only)

**Switches & Pilot Lights**
**Display Lights**
**Relays & Sockets**
**Lens/Buttons\***



Shape	Material	Part Number	Color Code
Lens (Round Flush) 	Polyarylate	LW1A-L1-Ⓢ	Specify color code in place of Ⓢ in the part number. A: amber C: clear G: green R: red S: blue Y: yellow Note: Use a clear lens for white illumination or for white (W) or black (B) buttons.
Lens (Round Extended) 	Polyarylate	LW1A-L2-Ⓢ	
Lens (Square Flush) 	Polyarylate	LW2A-L1-Ⓢ	
Lens for Pilot Lights (Round Extended) 	Polyarylate	LW1A-P2-Ⓢ	
Lens for Pilot Lights (Square Extended) 	Polyarylate	LW2A-P2-Ⓢ	
Illuminated Selector Knob Operator 	Plastic	LW9Z-FD6Ⓢ	

 \*Marking plate included with lens.

**Timers**
**Terminal Blocks**
**Marking Plates**

Shape	Material	Part Number	Color Code
Marking Plate (Round) 	Acrylic	LW9Z-P1W	For round flush pushbuttons, round flush illuminated pushbuttons, and round extended pilot lights.
Marking Plate (Square) 	Acrylic	LW9Z-P2W	For square flush pushbuttons, square flush illuminated pushbuttons, and square extended pilot lights.
Marking Plate (Round Extended) 	Acrylic	LW9Z-P12W	For round extended pushbuttons and round extended illuminated pushbuttons.

**Miscellaneous**
**Circuit Breakers**

Shape	Material	Part Number	Color Code
Locking Ring 	Plastic	LW9Z-LN	Black
Spare Key 	Metal	LW9Z-SK-500	Standard – default key
		LW9Z-SK-Ⓢ	Specify a key number 501 to 515 in place of Ⓢ in the part number.

Accessories

Shape	Material	Part Number	Description	Dimensions (mm)
<p>Locking Ring Wrench</p>	Metal (nickel-plated brass)	LW9Z-T1	Used to tighten the locking ring when installing into a panel. Tightening torque: 1.2 N·m	
<p>Lamp Holder Tool</p>	Rubber	OR-55	Used to install and remove LED lamps.	
<p>Lens Removal Tool</p>	Rubber (Ring: metal)	MT-S01	Used to remove the lenses.	
<p>Switch Guard with Lens (for Square Flush Lens) Spring Return Type</p>	Plastic (Guard: transparent)	LW9Z-KS7 <sup>Ⓢ</sup>	Switch guard accessory comes with lens. Cannot be used with maintained types (momentary buttons only). Specify a lens color code in place of <sup>Ⓢ</sup> in the part number. A: amber, C: clear, G: green, R: red, S: blue, Y: yellow Use a clear lens for white illumination or for white (W) or black (B) buttons.  Note: Determine mounting centers to ensure easy operation.	<p>Panel Thickness 0.8 to 3.2</p> <p>Mounting Hole Layout</p>
<p>Round Mounting Hole Plug</p>	Plastic (black)	LW9Z-BS6	Degree of protection: IP65 Panel thickness: 0.8 to 3.2 mm See page 675 for mounting hole layout.	
<p>Square Mounting Hole Plug</p>	Plastic (black)	LW9Z-BS7	Degree of protection: IP65 Panel thickness: 0.8 to 3.2 mm See page 675 for mounting hole layout.	
<p>Terminal Cover For Solder/Tab Terminal</p>	Plastic (translucent)	LW-VL2	For separate solder/tab terminal units only.	
<p>Terminal Cover For Screw Terminal</p>	Plastic (black)	LW-VL2M	For separate screw terminal units only.	
<p>Terminal Cover For Solder/Tab Terminal</p>	Plastic (translucent)	LW-PVL	For unibody solder/tab terminal pilot lights only.	
<p>Terminal Cover For Screw Terminal</p>	Plastic (translucent)	LW-PVLM	For unibody screw terminal pilot lights only.	

Switches & Pilot Lights

Display Lights

Relays & Sockets

Timers

Terminal Blocks

Circuit Breakers

Contact Blocks

Appearance	Style	Contact Material	Contact	Part Number		
				Solder/Tab	PC Board	Screw
	Non-illuminated Switches	Gold	SPDT	LW-C1	LW-C1V	—
			DPDT	LW-C2	LW-C2V	LW-C2M
			3PDT	LW-C3	LW-C3V	—
		Silver	SPDT	LW-C5	—	—
			DPDT	LW-C6	—	LW-C6M
			3PDT	LW-C7	—	—
	Illuminated Switches	Gold	SPDT	LW-C10	LW-C10V	—
			DPDT	LW-C20	LW-C20V	LW-C20M
			3PDT	LW-C30	LW-C30V	—
		Silver	SPDT	LW-C50	—	—
			DPDT	LW-C60	—	LW-C60M
			3PDT	LW-C70	—	—

Switches & Pilot Lights

Display Lights

Relays & Sockets

Timers

Terminal Blocks

Circuit Breakers

Dimensions (mm)

Non-illuminated Pushbuttons

Round/Square

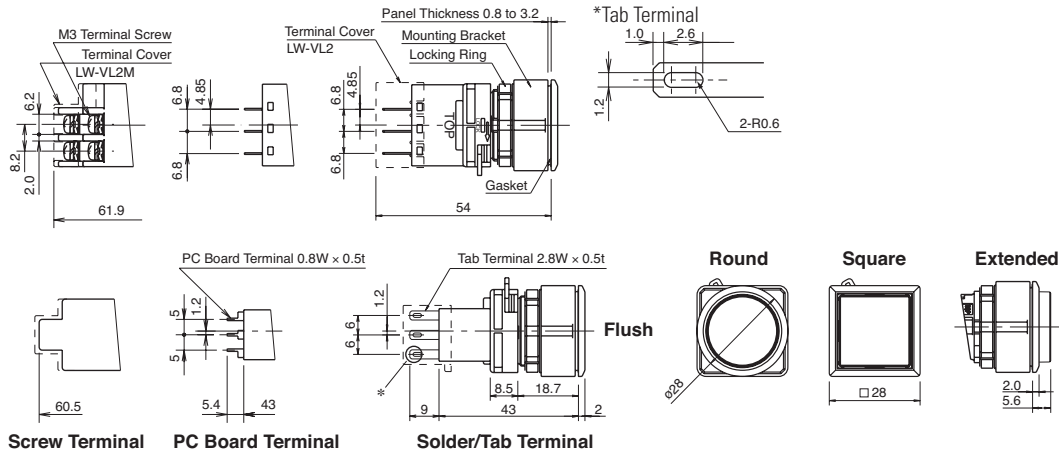

Square Flush Guard

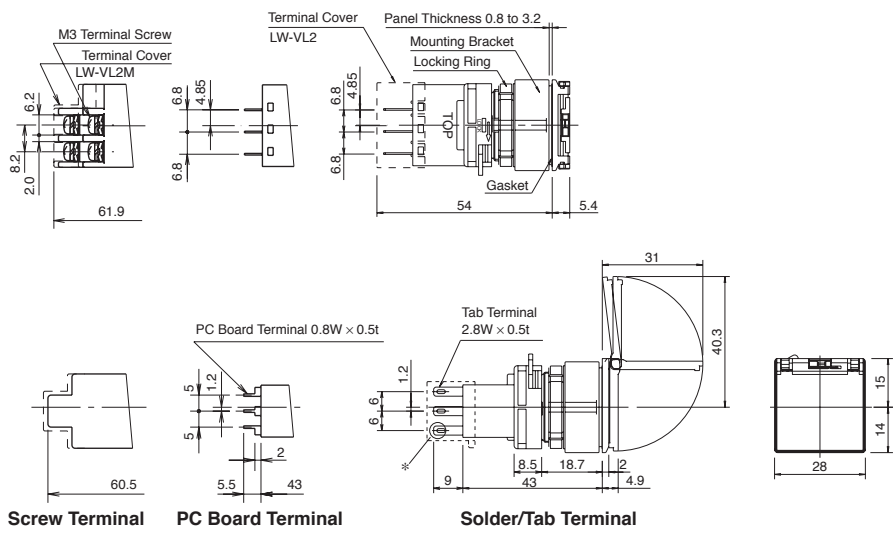

**Pilot Lights**

**Unibody**

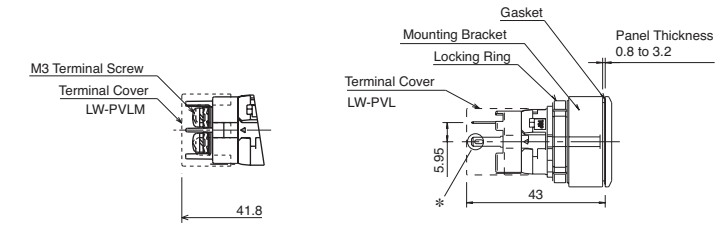

**Separate Model**

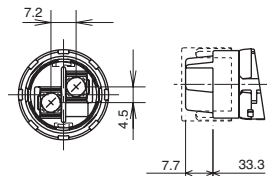
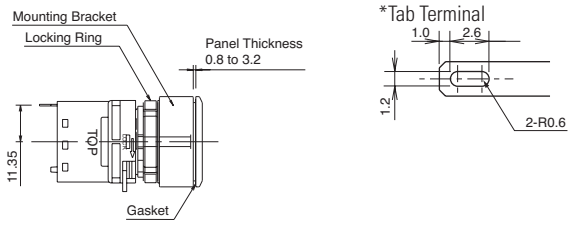

**Screw Terminal**

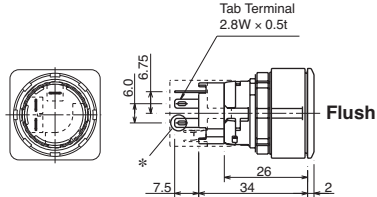

**Solder/Tab Terminal**

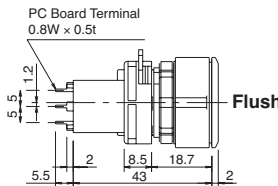

**PC Board Terminal**

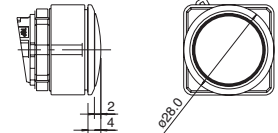

**Round (Extended)**

**Round**

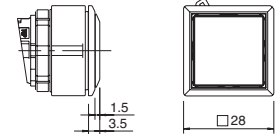

**Square (Extended)**

**Square**

**Illuminated Pushbuttons**

**Round/Square**

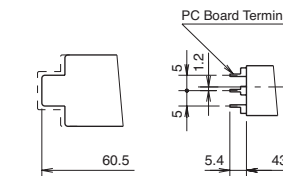
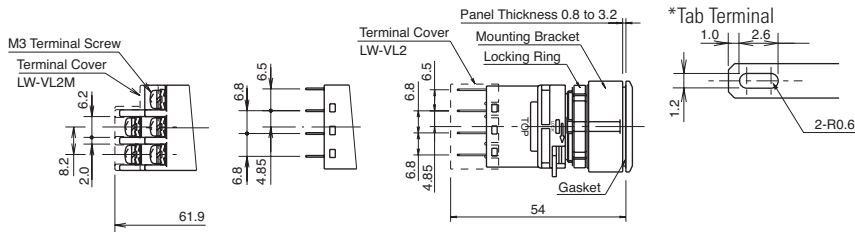

**Screw Terminal**

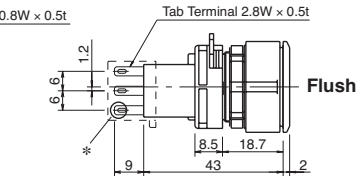

**PC Board Terminal**

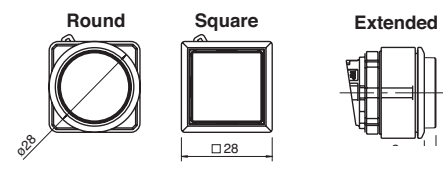

**Round**

**Square**

**Extended**

**Square Flush Guard**

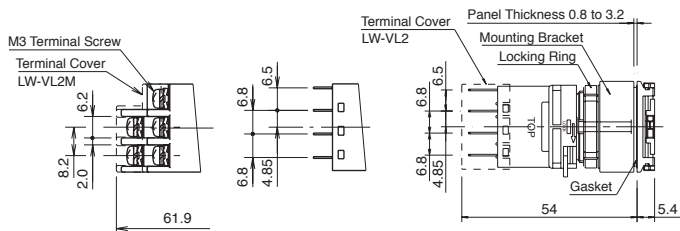

**Screw Terminal**

**Solder/Tab Terminal**

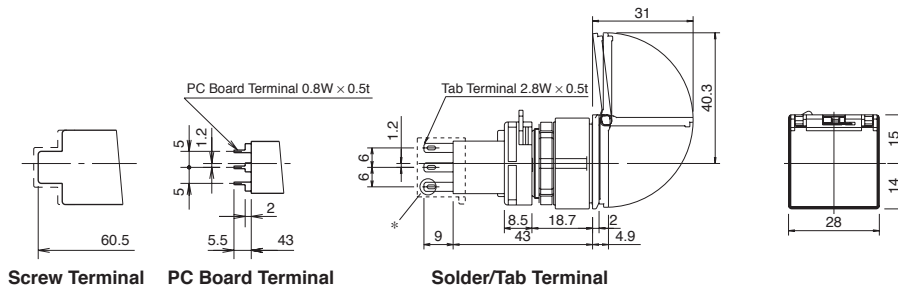

**Non-illuminated Selector Switches**

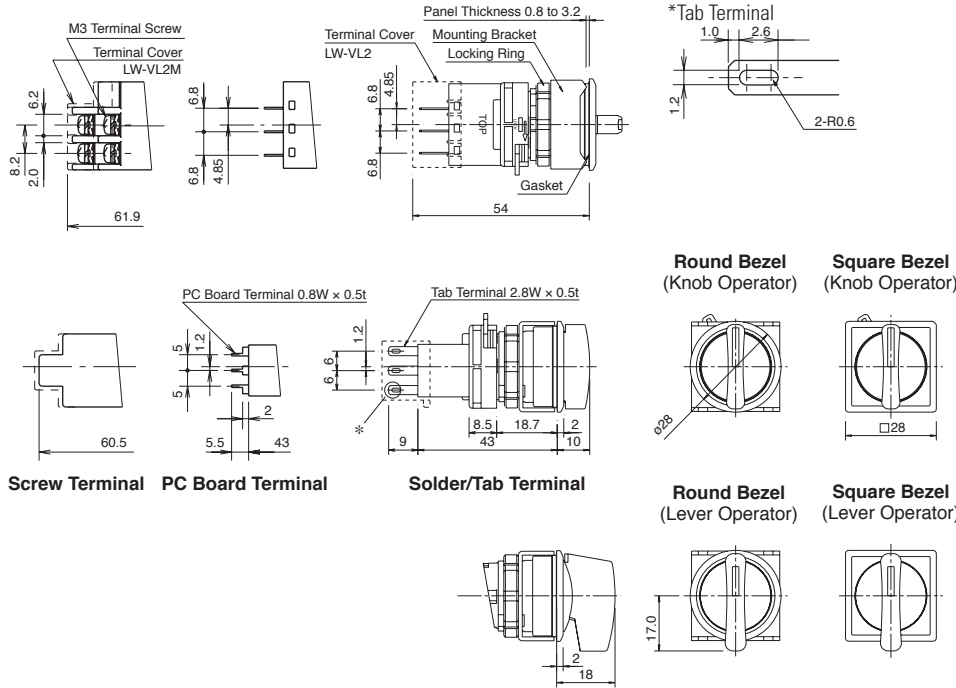

**Key Selector Switches**

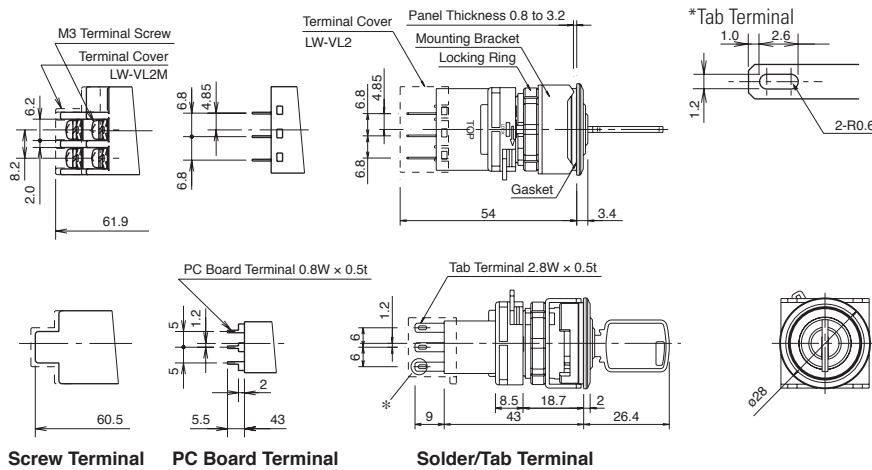



**Illuminated Selector Switches**

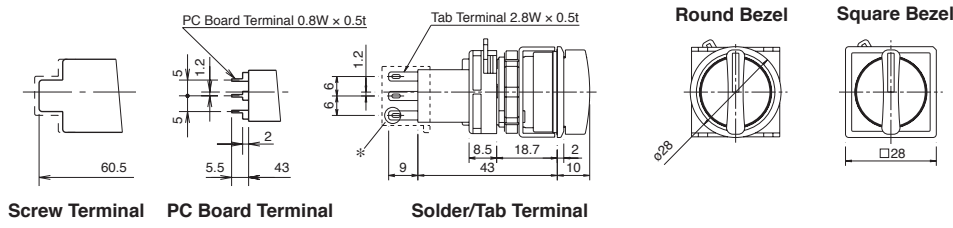
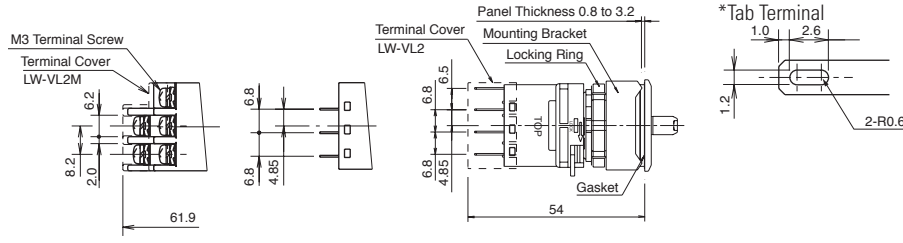

**Screw Terminal    PC Board Terminal    Solder/Tab Terminal**

**Bottom View**

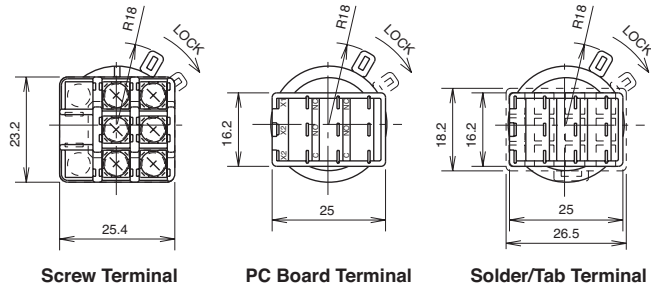

**Screw Terminal    PC Board Terminal    Solder/Tab Terminal**

**Terminal Arrangements**

**Illuminated Units (except pilot lights)**

**Solder/Tab Terminal**

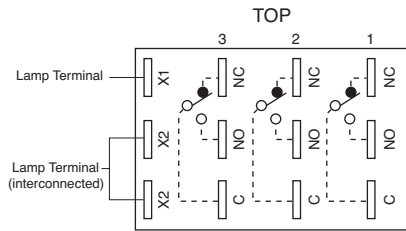

SPDT has C, NO, and NC only in the center. DPDT has C, NO, and NC only on the right and left. Screw terminal model is only available in DPDT configuration.

**Screw Terminal**

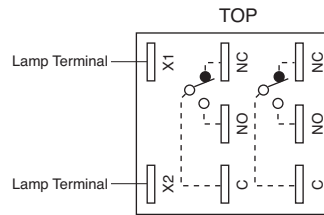

**All Non-illuminated Units**

**Solder/Tab Terminal**

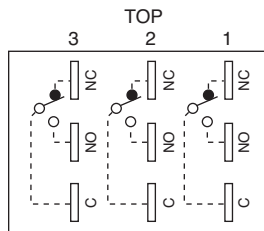

SPDT has C, NO, and NC only in the center. DPDT has C, NO, and NC only on the right and left. Screw terminal model is only available in DPDT configuration.

**Screw Terminal**

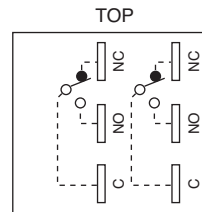

**Unibody Pilot Lights**

**Screw Terminal**

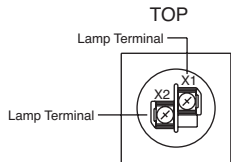

**Solder/Tab Terminal**

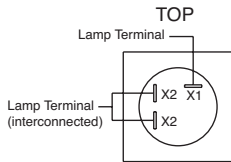

Lamp terminals do not have any polarity.

**Separate Model**

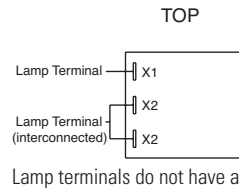

Lamp terminals do not have any polarity.

**Mounting Hole Layout**

**Round Models**

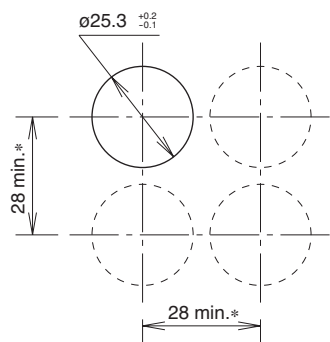

**Square Models**

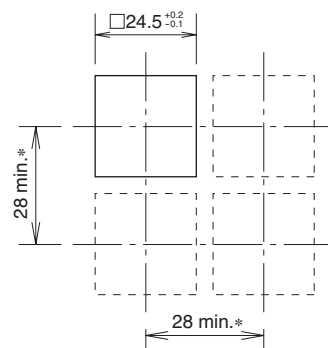

PC Board Drilling Layout (bottom view)

Non-illuminated Pushbuttons

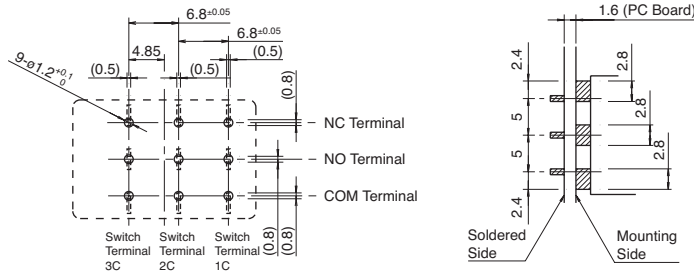

The pattern of the PC board as the terminals on the mounting surface are 2.8mm wide.

Pilot Lights

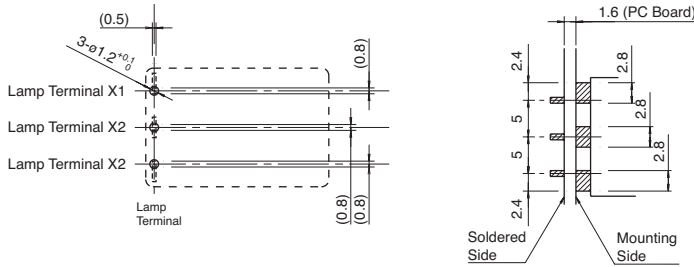

The pattern of the PC board as the terminals on the mounting surface are 2.8mm wide.

Illuminated Pushbuttons

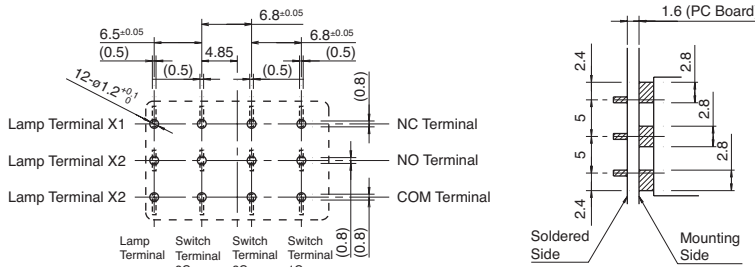

The pattern of the PC board as the terminals on the mounting surface are 2.8mm wide.

Contact Operation\*

Operation	Contact	Operator Position & Contact Position (Top View)		Operation	Contact	Operator Position & Contact Position (Top View)		
		Left	Right			Left	Center	Right
90° 2-Position L R	SPDT DPDT	Left Contact NO NC Right Contact NO NC	Left Contact NO NC Right Contact NO NC	45° 3-Position L C R	DPDT	Left Contact NO NC Right Contact NO NC	Left Contact NO NC Right Contact NO NC	Left Contact NO NC Right Contact NO NC
	3PDT	Left Contact NO NC Center Contact NO NC Right Contact NO NC	Left Contact NO NC Center Contact NO NC Right Contact NO NC			Left Contact NO NC Center Contact NO NC Right Contact NO NC	Left Contact NO NC Center Contact NO NC Right Contact NO NC	Left Contact NO NC Center Contact NO NC Right Contact NO NC

\*Valid for all Non-illuminated and Illuminated Selector Switches and Key Selector Switches.

### Safety Precautions

Turn off the power to the flush silhouette LW series before installation, removal, wiring, maintenance and inspection. Failure to turn power off may cause an electrical shock or fire hazard.

To avoid burning your hand, use the lamp holder tool when replacing lamps.

For wiring, use the correct size wires to meet voltage and current requirements. Solder correctly according to the instructions in **Wiring** and **Terminal Cover** (below and on following page). Tighten the M3.5 terminal screws to a torque of 0.6 to 1.0N·m. Failure to tighten terminal screws may cause overheating and increase risk of fire.

### General Instructions

#### Panel Mounting

Remove the contact block from the operator. Insert the operator into the panel cut out from the front, then install the contact block.

#### Removing the Contact Block

- Turn the locking lever on the contact block in the direction opposite to the arrow on the housing. The contact can then be removed.

#### Installing the Contact Block

- Insert the contact block, with the TOP markings on the contact block and the operator placed in the same direction. Then lock the units, turning the locking lever in the direction of the arrow.

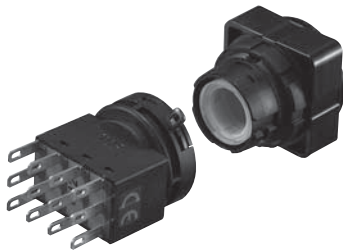

#### Replacement of the Lens & Marking Plate

##### Removal

- To remove the lens unit, press the suction cup of the optional lens removal tool (MT-S01) onto the lens and pull the lens unit out.



- Remove the marking plate by pushing the lens from the rear to disengage the latches between the lens and the lens holder, using a screwdriver as shown below.

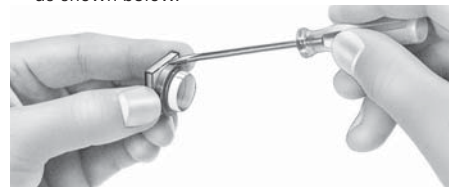

The translucent filter in the lens holder cannot be removed because the filter is sealed to make the unit waterproof and oiltight.

##### Installation

- For round lenses, place the marking plate on the lens holder with the anti-rotation projection engaged and press the lens into the lens holder to engage the latches. For square lenses, insert the marking plate into the lens, and press the lens into the holder to engage the latches.

- Make sure of the correct orientation of the marking plate.

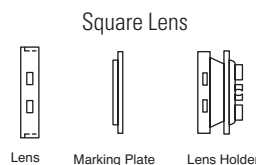
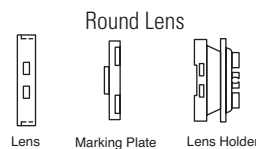

#### Marking Plate & Film

For LW series illuminated pushbuttons and pilot lights, legends and symbols can be engraved on marking plates, or printed film can be inserted under the lens for labelling purposes.

#### Marking Plate and Marking Film Size

Lens	Round Lens	Square Lens
Built-in Marking Plate		
Applicable Marking Film		
	<ul style="list-style-type: none"> <li>• Engraving must be made on the engraving area within 0.5mm deep.</li> <li>• The marking plate is made of acrylic resin.</li> </ul>	
	<ul style="list-style-type: none"> <li>• Two 0.1mm-thick films or one 0.2mm-thick film can be installed in the lens.</li> <li>• Marking film must be prepared separately.</li> <li>• Recommended marking film: polyester</li> </ul>	

#### Notes on Mounting

- Use the optional locking ring wrench (LW9Z-T1) to mount the operator into the panel. Tightening torque should not exceed 1.2N·m. Do not use pliers. Excessive tightening will damage the locking ring.

#### Collective Mounting

- As the locking lever can be turned easily from the rear of the units using a screwdriver, the contact blocks can be removed even when mounted collectively.

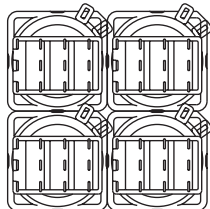

#### Insertion Order of Marking Plate and Film

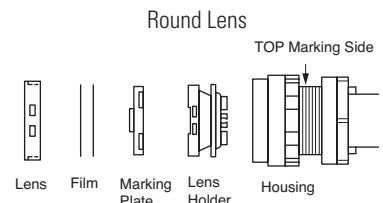

Note: Film must be prepared separately.

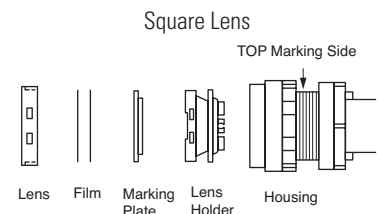

Film must be prepared separately. Make sure of correct orientation of the marking plate.

**Replacement of Lamps**

Lamps can be replaced using the lamp holder tool (OR-55) from the front of the panel, or by removing the contact block from the operator.

**Removing the Lamp**

- To remove, slip the lamp holder tool (OR-55) onto the lamp head. Then push slightly and turn the lamp holder tool counterclockwise.



**Installing the Lamp**

- To install, insert the lamp head into the lamp holder tool and hold the lamp as shown in the figure below.

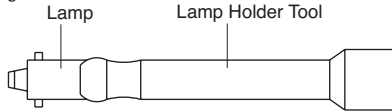

- Insert the pins on the lamp base into the grooves in the lamp socket. Insert the lamp and turn it clockwise.

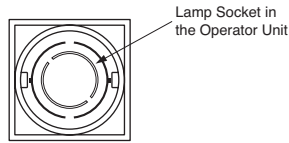

**Removing the Illuminated Selector Switch Knob**

**Removing the Knob**

Insert a flat screwdriver and remove the knob from the operator.

**Installing the Knob**

Press the knob into the operator. Align the recess on top end of the knob with the lowest rib on of the operator.

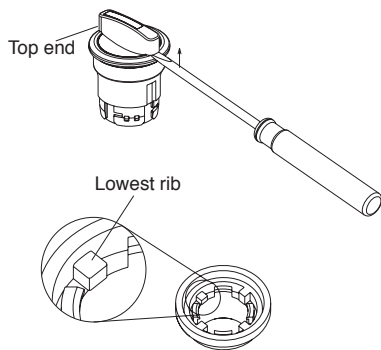

**Key Selector Switches**

When turning the key, do not pull the key out, otherwise, it may damage the switch.

**Wiring**

- Solder the terminals within 20W/5 sec or 260°C/3 sec without exerting external force on the terminals. Do not touch the plastic housing with the soldering iron. While wiring, prevent tension from being applied to the terminals. Do not bend or raise the terminals, or exert excessive force on the terminals.

- Use non-corrosive liquid flux.
- Positive-lock connector and easylock connectors are applicable to tab terminals.
- Tighten the terminal screw of the screw terminal models to a torque of 0.6 to 1.0N·m.

**Terminal Cover (for Solder/Tab Terminal)**

Insert the terminal cover onto the contact block with the TOP markings on the contact block and the terminal cover in the same direction.

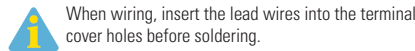

**Wiring Terminal Cover**

When installing a terminal cover onto the solder/tab terminal contact block, solder the inside of the lamp terminal (toward the switch terminals) and wire.

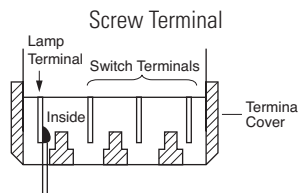

Install the terminal cover on the control unit before wiring.

- 1. After wiring, terminal covers cannot be installed.
- 2. When terminal covers are installed, ring terminals cannot be used. (For wiring, use fork terminals or lead wires directly.)

**Single Board Mounting**

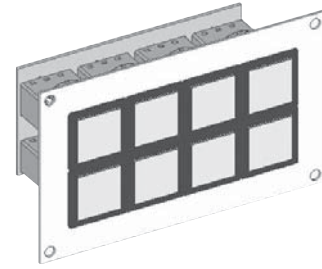

Mounting the control units on a single PC board offers the following features.

- Reduced installation labor, easy wiring, space saving and standardization.
- Since the contact blocks on the PC board can easily be removed using a locking lever, control units are easy to maintain.
- Because the control units require no studs for fastening the control units to a PC board, special preparation of the panel is not needed.

## X-ON Electronics

Largest Supplier of Electrical and Electronic Components

*Click to view similar products for [Industrial Panel Mount Indicators / Switch Indicators](#) category:*

*Click to view products by [Idec](#) manufacturer:*

Other Similar products are found below :

[01-121.022](#) [LW1A-P1-W](#) [LW1B-A0L](#) [01-952.0](#) [01-152.025](#) [D38999/20FJ29PB L/C](#) [704-6012](#) [704-6020](#) [704-6023](#) [704-6026](#) [73.362.4028.0](#)  
[EUS-704.000.7](#) [750-1520](#) [9001OA120](#) [99-450.837](#) [99-455.837](#) [99-486.837](#) [99-901.9](#) [99-902.9](#) [99-908.0](#) [99-909.4](#) [99-909.5](#) [A0244J1](#)  
[A3DT-500Y](#) [AL6M-P7P-A](#) [AOLQW-2B0600](#) [AP1M255-A](#) [APD106LN-A](#) [APD106LN-G](#) [APN1126-G](#) [APS122DN-W](#) [ATN2100](#)  
[AYLW4L-A](#) [18-237.035](#) [C0180AANAHA](#) [HW1A-L1-GD](#) [HW1A-P2-GL](#) [HW1F-3G](#) [HW1R-2DF20-R](#) [HW1X-BM411-R](#) [HW2A-L1-GL](#)  
[HW2A-P1-GD](#) [HW4S-31L](#) [HWAZ1N-OB](#) [PA2200/1](#) [PA2SHIELD](#) [21-931.0](#) [21-931.2](#) [96-923.5](#) [1625006](#)