



*Think Automation and beyond...*



***IDEC Hydraulic-Magnetic Circuit Breakers***  
***NC1V Series***



# Protection

## Specifications

<b>Operator Style</b>		Retractable lever		
<b>Internal Circuit</b>		Series trip (current trip), Relay trip (voltage trip)		
<b>Protection Method</b>		Hydraulic magnetic tripping system, Magnetic tripping system (voltage trip)		
<b>No. of Poles</b>		1-pole	2-pole	3-pole
<b>Rated Voltage (AC/DC)</b> <sup>Note 1</sup>		250V AC 50/60Hz, 65V DC	250V AC 50/60Hz, 125V DC	250V AC, 50/60Hz
<b>Series Trip (Current Trip)</b>	<b>Rated Short-circuit Capacity</b>	250V AC, 2500A 65V DC, 2500A	250V AC, 2500A 125V DC, 2500A	250V AC, 2500A
	<b>Rated Current</b>	0.1A, 0.3A, 0.5A, 1A, 2A, 3A, 5A, 7A, 10A, 15A, 20A, 25A, 30A		
	<b>Operation Characteristics</b> <sup>Note 2</sup>	Time delay curve curve M (slow), curve A (medium), S (instantaneous), Curves M and A are also available with inertia delay option.		
<b>Relay Trip (Voltage Trip)</b> <sup>Note 3</sup>	<b>Rated Current</b>	30A		
	<b>Trip Voltage</b>	24 to 48V DC (at 25°C), Voltage application duration 10 sec maximum, tripping time 0.1 sec maximum (at rated voltage)		
<b>Auxiliary Contact/ Alarm Contact</b>	<b>Contact Rating</b>	125V AC 3A (resistive load), 30V DC 2A (resistive load)		
	<b>Minimum Applicable Load</b>	24V DC 1mA (resistive load, reference value)		
<b>Insulation Resistance</b>		100MΩ minimum (500V DC megger)		
<b>Dielectric Strength</b>		2,000V AC, 1 minute (between terminals when main contacts are open, between live parts of different poles, between live and dead parts) 600V AC (between terminals when auxiliary circuits are open)		
<b>Vibration Resistance (with rated current applied)</b>		Damage limits: 147m/s <sup>2</sup> (10 to 55Hz) (1-pole, 2-pole), 78m/s <sup>2</sup> (3-pole) Operating extremes: 98m/s <sup>2</sup> (1-pole, 2-pole), 78m/s <sup>2</sup> (3-pole)		
<b>Shock Resistance (S time delay curve: 80% rated current, A, M time delay curve: 100% rated current)</b>		Damage limits: 490m/s <sup>2</sup> (1-pole, 2-pole), 297m/s <sup>2</sup> (3-pole) Operating extremes: 196m/s <sup>2</sup> (S, A, M types)		
<b>Electrical Life</b>		10,000 cycles minimum (at rated current), 10 operations per minute		
<b>Reference Temperature</b>		40°C		
<b>Operating Temperature</b>		-10 to +60°C (no freezing) Rated current is based on an ambient temperature of 40°C. When the operating temperature exceeds 40°C, derate the rated current by using the factors shown below.		
<b>Operating Humidity</b>		45 to 85% RH (no condensation)		
<b>Terminal Style</b>	<b>Main Circuit Terminal</b>	Spring-up, fingersafe terminal: M4 screw (up to 20A), M5 screw (25A and 30A)		
	<b>Auxiliary/Alarm Contacts, Voltage Coil Terminal</b>	M3.5 screw		
<b>Weight (approx.)</b>		1-pole: 90g, 2-pole: 170g, 3-pole: 260g		

1. 3-pole type is for AC voltage only.

2. For S (instantaneous) tripping curve, humming sound may occur when used in an AC sinusoidal-wave current circuit around 80% of the rated current, however, the performance of the circuit breaker will not be affected.

To avoid unnecessary tripping, do not use in circuits where inrush currents may be present.

3. Relay trip (voltage trip) type is not equipped with an overcurrent trip function.

Do not use the NC1V circuit breakers in environments where they are exposed to extreme temperature, humidity, dust, corrosive gases, vibration, shock, or in a circuit where inrush current may be present, otherwise unnecessary operation and damage may occur.

Operating Temp.	Derating Factor
50°C	0.9
55°C	0.8
60°C	0.7

## Part Number Configuration

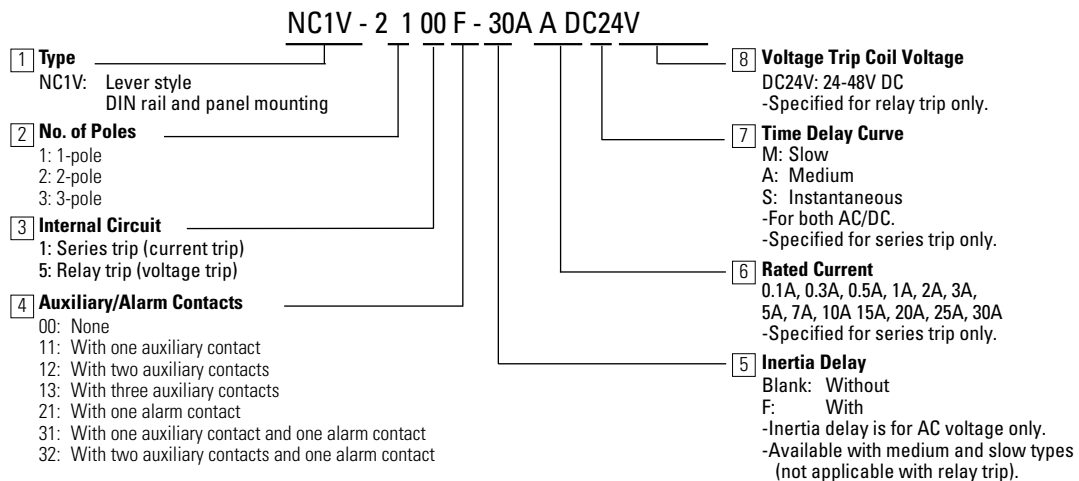

# Performance

## Internal Circuits

### 1-pole

NC1V-1100  
(Without auxiliary/alarm contacts)

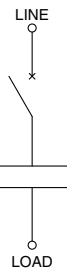

NC1V-1111  
(With auxiliary contact.  
One auxiliary contact.

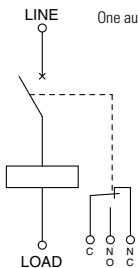

NC1V-1121  
(With alarm contact.  
One alarm contact.

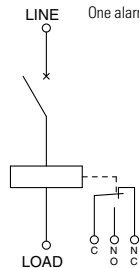

NC1V-1500  
(Relay Trip)

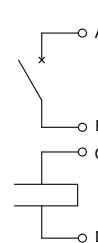

### 2-pole

NC1V-2100  
(Without auxiliary/alarm contacts)

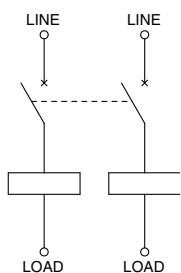

NC1V-2111  
(With auxiliary contact.  
One auxiliary contact.  
Also available with two  
auxiliary contacts.

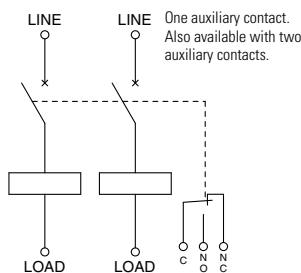

NC1V-2121  
(With alarm contact.  
One alarm contact.  
Also available with  
one auxiliary contact  
and one alarm contact.

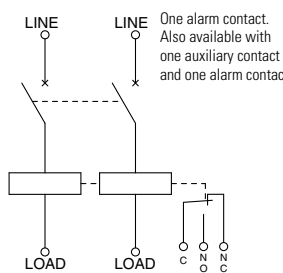

NC1V-2500  
(Relay Trip)

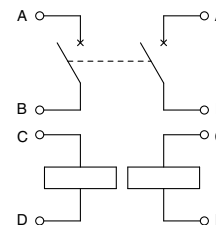

### 3-pole

NC1V-3100  
(Without auxiliary/alarm contacts)

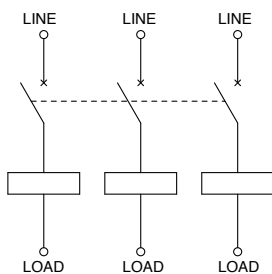

NC1V-3111  
(With auxiliary contact.  
One auxiliary contact. Also available with  
two or three auxiliary contacts.

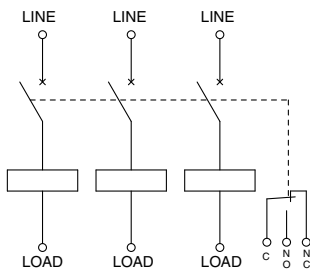

NC1V-3121  
(With alarm contact.  
One alarm contact. Also available with one  
auxiliary and one alarm contacts, and two  
auxiliary and one alarm contacts.

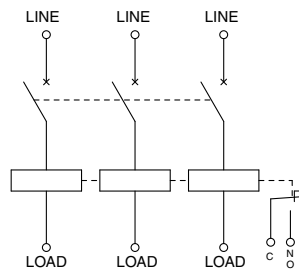

NC1V-3500  
(Relay Trip)

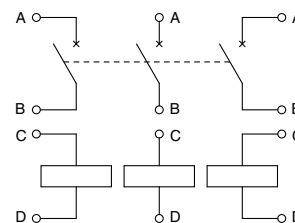

## Overcurrent-Time Delay Characteristics (sec at 40°C) [vertical mounting]

Item	Time Delay Curve	Percent of Rated Current								
		100%	125%	150%	175%	200%	400%	600%	800%	1000%
AC (50/60Hz)/DC	S (instantaneous)	NO TRIP	—	*0.005 to 0.1	0.003 to 0.06	0.0027 to 0.05	0.002 to 0.03	0.002 to 0.028	0.002 to 0.025	0.002 to 0.022
	A (medium)	NO TRIP	*25 to 240	16 to 140	—	6 to 32	0.4 to 4	0.0055 to 1.5	0.004 to 0.8	0.004 to 0.65
	M (slow)	NO TRIP	*60 to 600	30 to 200	—	9 to 60	0.4 to 10	0.006 to 4.5	0.004 to 1.8	0.004 to 0.8
AC (50/60Hz)	With Inertia Delay A (medium)	NO TRIP	25 to 240	—	—	6 to 32	0.8 to 6	0.09 to 3.5	0.02 to 1.8	0.01 to 1.0
	With Inertia Delay M (slow)	NO TRIP	60 to 600	—	—	10 to 60	0.8 to 10	0.06 to 4.5	0.02 to 3	0.01 to 1.75

\*MAY TRIP on DC

## Time Delay Curve and Ambient Temperature

NC1V circuit breakers employ an electromagnetic tripping system, where the rated current (trip current) is not affected by ambient temperatures. But, the time delay may vary with the oil viscosity in the oil dash pot. Lower oil viscosity at higher temperatures results in a shorter delay, whereas at lower temperatures, the delay will be longer.

## Temperature Correction Curve

The time delay curves on the preceding page are measured at 40°C. With reference to the following curves, time delays can be corrected according to ambient temperature.

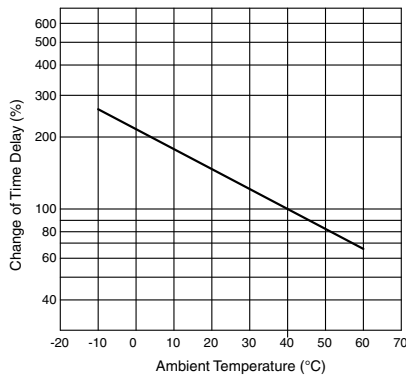

The time delay is based on an ambient temperature of 40°C. Time delays at other temperatures are corrected according to the temperature correction curve. The time delay of the instantaneous time delay curve (S) is not affected by the ambient temperature.

When operating temperature exceeds 40°C, derate the rated current by multiplying the derating factor shown on the right.

Operating Temp.	Derating Factor
50°C	0.9
55°C	0.8
60°C	0.7

## Inertia Delay

Inertia delay is designed not to trip on a non-repeating single pulse of 20 times the rated current (peak value) for a duration of 8ms. In addition, circuit breakers equipped with inertia delay do not respond to high inrush currents caused by transformer or lamp loads, but perform the specified interruption on subsequent overcurrents. Inertia delay is available on AC circuits, and is not available with the series trip curve S (instantaneous).

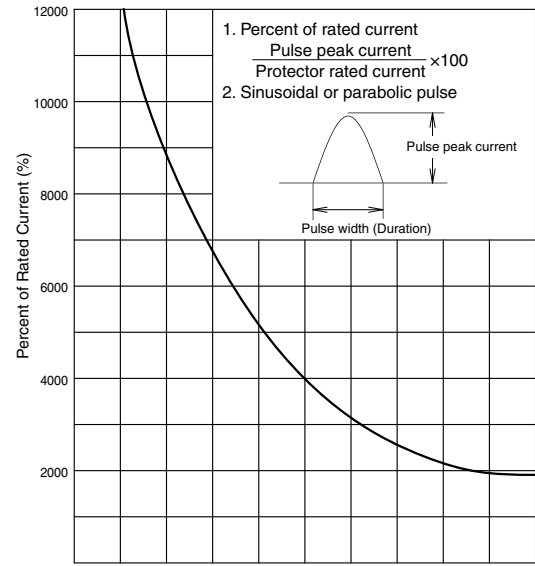

## Impedance and Coil Resistance

### Series Trip (Current Trip) at 25°C

Rated Current	For AC 50/60 Hz Impedance (Ω)		For DC Resistance (Ω)	
	Curve S	Curves A, M	Curve S	Curves A, M
0.1A	66.0	116.0	43.0	106.0
0.3A	6.6	11.0	4.1	10.0
0.5A	1.92	3.65	0.86	3.40
1A	0.50	0.93	0.25	0.90
2A	0.16	0.27	0.11	0.25
3A	0.07	0.12	0.050	0.11
5A	0.025	0.050	0.015	0.045
7A	0.014	0.027	0.011	0.025
10A	0.007	0.021	0.005	0.020
15A	0.006	0.010	0.005	0.009
20A	0.005	0.006	0.004	0.005
25A	0.004	0.005	0.004	0.005
30A	0.003	0.004	0.003	0.004

Tolerance: ±25% (up to 20A),  
±50% (25A and 30A)

### Relay Trip (Voltage Trip) at 25°C

Tripping Voltage	For DC Resistance (Ω)
24-48V	100.0

Tolerance: ±25%

## Voltage Drop Due to Coil Resistance or Impedance

The internal resistance or impedance of a circuit breaker tends to be larger for a smaller-rated current. Therefore, when circuit breakers with a small rated current are used, voltage drop should be taken into consideration. Internal resistance also varies with time delay curves, which should also be considered during installation.

## 3-pole

NC1V-3100

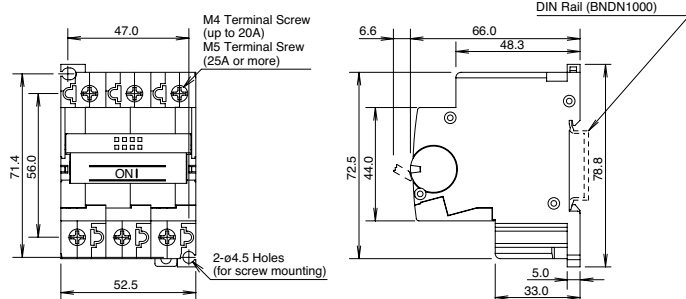

NC1V-3111 (one auxiliary contact), NC1V-3112 (two auxiliary contacts)  
 NC1V-3113 (three auxiliary contacts), NC1V-3121 (one alarm Contact)  
 NC1V-3131 (one auxiliary and one alarm contact)  
 NC1V-3132 (two auxiliary and one alarm contacts)

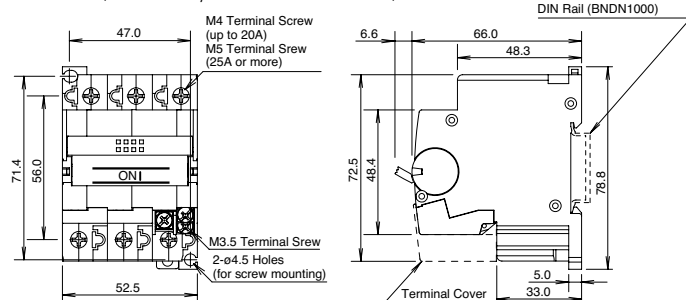

Dimensions shown are for NC1V-3111 and NC1V-3121.

NC1V-3500 (Relay Trip)

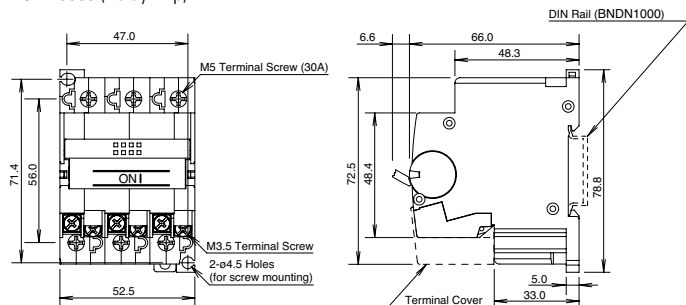

Mounting Hole Layout (M4 Mounting Screws)

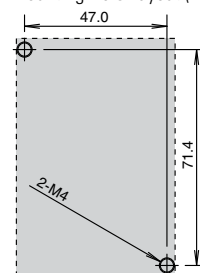

## Instructions

### Installation Angle

Tripping method is hydraulic magnetic. Minimum operating current varies with installation angle. Operating currents are influenced by the weight of movable iron core. With reference to the following figures, correct the rated current.

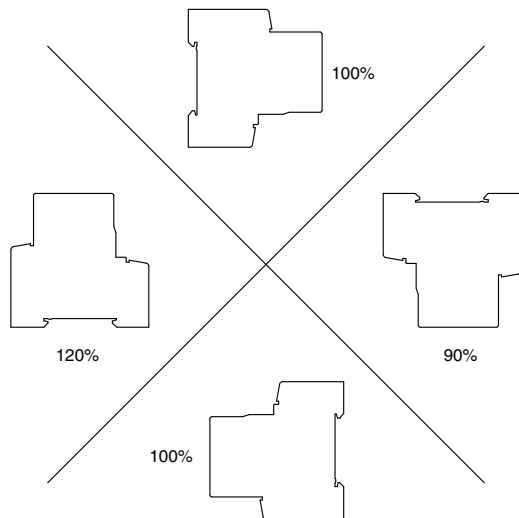

Minimum operating current is calculated from the following formula:  
 (Minimum operating current) = (Rated current) × (Correction factor by installation angle) × (Reference minimum tripping current rate)

### DIN Rail Installation

1. Fasten the DIN rail securely.
2. With the latch facing downward, install the NC1V circuit breaker on the DIN rail as shown below.

### DIN Rail Removal

Using a flat screwdriver, pull the latch on the circuit breaker to remove from the DIN rail.

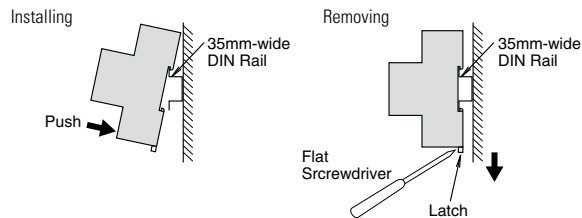

800.262.4332

www.IDEC.com/circuitbreaker

# PS6R: World's First Expandable Power Supply



## Less cost + less space = more savings! More value!

Replace 3 full-priced, space-consuming power supplies with 1.

## Reduce the amount of space needed for wiring and installation

The addition of a DC-DC converter expansion module will eliminate the need for multiple power supplies or snap on a branch terminal module to replace multiple terminal blocks.

## Flexibility, expandability, versatility

Add DC-DC converter units for up to three separate output voltages (5, 12, or 15V). Or, add a branch terminal module to get two additional + and – slots.

## Energy-saving 93% Efficiency

Save energy and generate less heat in the cabinet, reducing temperature stress on critical components.

## Easy Maintenance - LED Indicator

DC low or ON indicator.

## Technical support:

support@idec.com

## Sales support:

sales@idec.com

800.262.4332

www.IDEC.com/usa

**IDEC** *Think Automation and beyond...*

FSC Placement

www.IDEC.com

### USA

IDEC Corporation  
Tel: (408) 747-0550  
opencontact@idec.com

### Canada

IDEC Canada Ltd.  
Tel: (905) 890-8561  
sales@ca.idec.com

### Australia

IDEC Australia Pty. Ltd.  
Tel: +61-3-8523-5900  
sales@au.idec.com

### Japan

IDEC Corporation  
Tel: +81-6-6398-2527  
marketing@idec.co.jp

### Germany

IDEC Elektrotechnik GmbH  
Tel: +49-40-253054-0  
service@idec.de

### China

IDEC (Beijing) Corporation  
Tel: +86-10-6581-6131  
IDEC (Shanghai) Corporation  
Tel: +86-21-6135-1515  
idec@cn.idec.com

IDEC (Shenzhen) Corporation  
Tel: +86-755-8356-2977

### Hong Kong

IDEC (H.K.) Co., Ltd.  
Tel: +852-2803-8989  
info@hk.idec.com

### Singapore

IDEC Asia Pte. Ltd.  
Tel: +65-6746-1155  
info@sg.idec.com

### Taiwan

IDEC Taiwan Corporation  
Tel: +886-2-2698-3929  
service@tw.idec.com

### Thailand

IDEC Asia (Thailand) Co., Ltd.  
Tel: +662-392-9765  
sales@th.idec.com

### United Kingdom

IDEC Electronics Ltd.  
Tel: +44-1256-321000  
sales@uk.idec.com

©2014 IDEC Corporation. All Rights Reserved.  
Catalog No. NC9Y-B100-2 08/14 5K

Specifications and other descriptions in this catalog are subject to change without notice.

## X-ON Electronics

Largest Supplier of Electrical and Electronic Components

*Click to view similar products for [Other Tools](#) category:*

*Click to view products by [Idec](#) manufacturer:*

Other Similar products are found below :

[CR-05FL7--150R](#) [CR-05FL7--698K](#) [899-2-KT46](#) [899-5-KT46](#) [CR-0AFL4--332K](#) [CR-12FP4--260R](#) [CRCW04021100FRT7](#)  
[CRCW04021961FRT7](#) [5800-0090](#) [CRCW04024021FRT7](#) [CRCW040254R9FRT7](#) [CRCW0603102JRT5](#) [59065-5](#) [00-8273-RDPP](#) [00-8729-](#)  
[WHPP](#) [593033](#) [593058](#) [593072](#) [593564100](#) [593575](#) [593591](#) [593593](#) [011349-000](#) [LTLA506SBLAMNBL](#) [CRCW08052740FRT1](#) [LUC-](#)  
[012S070DSM](#) [LUC-018S070DSP](#) [599-2021-3-NME](#) [599-JJ-2021-03](#) [00-5080-YWPP](#) [5E4750/01-20R0-T/R](#) [LW1A-L1-GL](#) [LW1A-P1-GD](#)  
[LW1L-A1C10V-GL](#) [LW1L-M1C70-A](#) [0202-0173](#) [00-9089-RDPP](#) [00-9300-RDPP](#) [CRCW2010331JR02](#) [01-1003W-8/32-10](#) [601-GP-08-](#)  
[KT39](#) [601-JJ-06](#) [601-SPB](#) [601YSY](#) [602-JJ-03](#) [602SPB](#) [602Z](#) [603-JJ-07-FP](#) [603-JJY-04](#) [604J](#)