

HW Series – 22mm IEC Style Global Pushbuttons

Key features:

- Locking lever removable contact blocks
- Finger-safe IP20 contacts as standard, other terminal styles available
- Tamperproof construction
- All E-stops meet EN418 and are compliant with SEMI S2 standards
- Worldwide approvals
- Easy to assemble
- Choice of black plastic or metallic front bezels
- Incandescent or LED illumination
- Transformer or full voltage
- Slow make double break self cleaning contacts



HW: The Best Engineered Switch in the World

IDEC's HW switches are "The best engineered switch in the world" for a reason. Carrying the CE mark, UL, CSA, CCC (Chinese), and TUV approvals, these switches are designed for use in almost any part of the world.

lights, selector switches, and emergency stop switches.

All switches also incorporate mechanically keyed safety locking levers, ensuring correct installation and maintaining safety in high-vibration applications.

Complete with finger-safe contact blocks offering IP20 protection, these 7/8" (22mm) switches include illuminated and non-illuminated pushbuttons, pilot



File No. E68961



File No. LR92374



Registration No. R9551089 (E-stops)
 Registration No. R50054316 (Dual Pushbuttons)
 Registration No. J9650511 (Pilot Lights)
 Registration No. J9551458 (all other switches)









TÜV Rheinland
 Certificate No.
 2005010305145656



Specifications

Electrical	Rated Operational Characteristics	AC-15: A600 or Ue = 250V, Ie = 3A (NO, NC, NO-EM, NC-LB) DC-13: P600 or Ue = 125V, Ie = 1.1A (NO, NC) DC-13: Q600 or Ue = 125V, Ie = 0.9A (NO-EM, NC-LB)
	Maximum Inrush Current	40 A (40 ms)
	Rated Insulation Voltage	600V
	Rated Switching Over-Voltage	Less than 4kV, conforming to IEC60947-1
	Rated Impulse Withstanding Voltage	4kV for contact circuit, 2.5kV for lamp circuit
	Rated Thermal Current	10 Amp
	Minimum Switching Capacity	5 mA at 3V AC/DC
	Electrical Reliability	MTBF < 1 fault for 10 million operation cycles (3V DC, 5mA)
Lamp Ratings	Incandescent: 1 W LEDs: 6V/17mA max, 12V & 24V/11mA max, 120 & 240V/10mA max	

Mechanical	Contact Operation	Slow break NC or NO, self-cleaning							
	Positive Action Operation (Emergency Stops with NC contacts)	5.5mm to 10mm travel to latch, 45N minimum force to latch 10mm maximum travel, 1,800 operations per hour maximum for a Pushlock Turn Reset 900 operations per hour maximum for a Push-Pull							
	Operating Force	Flush and extended pushbuttons—with 1NO or 1NC contact: 6.2±2N (momentary), 7.0±2N (maintained) Additional contacts—1NO or 1NC: +3.2N (momentary), + 3.3N (maintained)							
	Recommended Terminal Torque	0.8 N m (7.1 in lb.)							
	Applicable Wire Size	Minimum 1 x 22 AWG, max. 2 x 14 AWG or 1 x 12 AWG							
	Contact Resistance	Initial contact resistance of 50mΩ or less							
	Contact Gap	4mm (NO and NC), 2mm (NO-EM and NC-LB)							
	Horsepower Rating	Reference Value: 1/4 HP @ 120V (1Ø non-reversing), 1HP @ 240V (3Ø non-reversing)							
	Contact Material	Silver (gold plated contacts available - contact IDEC)							
	Operating Temperature	Operation: -25 to +50°C (without freezing), Storage: -40 to +70°C (without freezing)							
Vibration Resistance	10 to 55Hz, 98m/sec ² (10G) conforming to IEC6068-2-6								
Shock Resistance	980m/sec ² (100G) conforming to IEC6068-2-7								
Mechanical Life	Momentary pushbuttons: 5,000,000 (900 operations per hour), All other switches: 500,000								
Conforming to Standards	EN60947-1, EN60947-5-1, VDE0660-200, UL508, CSA C22-2 No.14								
Standards & Approvals	Approvals	 File No. E68961  File No. LR92374   Registration No. R9551089 (E-stops) Registration No. R50054316 (Dual Pushbuttons) Registration No. J9650511 (Pilot Lights) Registration No. J9551458 (all other switches)  TÜV Rheinland Certificate No. 2005010305145656							
	Electric Shock Protection	Class 0 conforming to IEC60536							
	Degree of Protection (conforming to IEC60529) (conforming to NEMA ICS6-110)	IP65 (from front of the panel) IP20 (Type HW-F contact block) NEMA 1, 2, 3, 3R, 3S, 4, 4X, 5, 12, 13 (from front of panel)							
	Pollution Degree (conforming to IEC60947-1)	3 for switches not using a transformer, 2 for switches using a transformer							
	External Short-Circuit Protection	10A 250V fuse conforming to IEC60269-1							
Terminal Referencing	Conforming to CENELEC EN50005								
Contact Ratings	Pushbuttons	Contact Block						Type HW-C/HW-F /HW-G	
	Illuminated Pushbuttons	Rated Insulation Voltage	600V						
	Selector Switches	Rated Continuous Current	10A						
	Illuminated Selector Switches Pushbutton Selectors	Contact Ratings by Utilization Category IEC 60947-5-1	AC-15 (A600) DC-13 (P600)						
Characteristics	Operational Voltage		24V	48V	50V	110V	220V	440V	
	Operational Current	AC 50/60 Hz	AC-12 Control of resistive loads & solid state loads	10A	—	10A	10A	6A	2A
			AC-15 Control of electromagnetic loads (> 72VA)	10A	—	7A	5A	3A	1A
		DC	DC-12 Control of resistive loads & solid state loads	8A	5A	—	2.2A	1.1A	—
			DC-13 Control of electromagnets	5A	2A	—	1.1A	0.6A	—

 For dimensions, see page 601.

LED Lamp Ratings (LSTD Type)

Model			LSTD-6②	LSTD-1②	LSTD-2②	LSTD-H2②	LSTD-M4②
Lamp Base			BA9S/13				
Rated Voltage			6V AC/DC	12V AC/DC	24V AC/DC	120V AC	240V AC
Voltage Range			6V AC/DC ±10%	12V AC/DC ±10%	24V AC/DC ±10%	120V AC ±5%	240V AC ±5%
Current Draw	AC	A, R, W: G, S:	17mA 8mA	11mA	11mA	10mA	10mA
	DC	A, R, W: G, S:	14mA 5.5mA	10mA	10mA	—	—
Color Code			A (amber), G (green), R (red), S (blue), W (white)				
Lamp Base Color			Same as illumination color				
Voltage Marking			Die stamped on the base				
Life (reference value)			Approx. 50,000 hours (The luminance reduces to 50% the initial intensity when used on complete DC.)				
Internal Circuit	A, R, W						
	A, R, W						
	G, S						
			<ul style="list-style-type: none"> LED Chip Protection Diode Zener Diode 				

In place of ②, specify the Lens/LED Color Code.

Switches & Pilot Devices

Signaling Lights

Relays & Sockets

Timers

Contactors

Terminal Blocks

Circuit Breakers

Non-Illuminated Round Pushbuttons (Assembled)



Function	Contacts	Round Flush		Round Extended	
		Plastic Bezel	Metal Bezel	Plastic Bezel	Metal Bezel
Momentary	Operator Only	<i>HW1B-M1-①</i>	<i>HW4B-M1-①</i>	<i>HW1B-M2-①</i>	<i>HW4B-M2-①</i>
	1NO	HW1B-M1F10-①	HW4B-M1F10-①	HW1B-M2F10-①	HW4B-M2F10-①
	1NC	HW1B-M1F01-①	HW4B-M1F01-①	HW1B-M2F01-①	HW4B-M2F01-①
	1NO-1NC	HW1B-M1F11-①	HW4B-M1F11-①	HW1B-M2F11-①	HW4B-M2F11-①
	2NO	HW1B-M1F20-①	HW4B-M1F20-①	HW1B-M2F20-①	HW4B-M2F20-①
	2NC	HW1B-M1F02-①	HW4B-M1F02-①	HW1B-M2F02-①	HW4B-M2F02-①
	2NO-2NC	HW1B-M1F22-①	HW4B-M1F22-①	HW1B-M2F22-①	HW4B-M2F22-①
Maintained	Operator Only	<i>HW1B-A1-①</i>	<i>HW4B-A1-①</i>	<i>HW1B-A2-①</i>	<i>HW4B-A2-①</i>
	1NO	HW1B-A1F10-①	HW4B-A1F10-①	HW1B-A2F10-①	HW4B-A2F10-①
	1NC	HW1B-A1F01-①	HW4B-A1F01-①	HW1B-A2F01-①	HW4B-A2F01-①
	1NO-1NC	HW1B-A1F11-①	HW4B-A1F11-①	HW1B-A2F11-①	HW4B-A2F11-①
	2NO	HW1B-A1F20-①	HW4B-A1F20-①	HW1B-A2F20-①	HW4B-A2F20-①
	2NC	HW1B-A1F02-①	HW4B-A1F02-①	HW1B-A2F02-①	HW4B-A2F02-①
	2NO-2NC	HW1B-A1F22-①	HW4B-A1F22-①	HW1B-A2F22-①	HW4B-A2F22-①

① Button Color Code

Color	Code
Black	B
Green	G
Red	R
Blue	S
White	W
Yellow	Y
Gray	N*

*Gray available for round flush only.



1. In place of ①, specify the Button Color Code from table below.
2. For nameplates and accessories, see page 596 and 599.
3. For dimensions, see page 601.
4. For contact assembly part numbers, see page 600.
5. All assembled part numbers in catalog include standard, fingersafe (HW-F...) contacts.
6. Assembled units with spring-up terminals (HW-G...) can be ordered by removing an "F" from the part number (Ex. HW1B-M1F11-R becomes HW1B-M111-R).
7. Operator only models include operator plus button.
8. Additional contact configurations available (up to 6 total contacts).

Part Number Structure

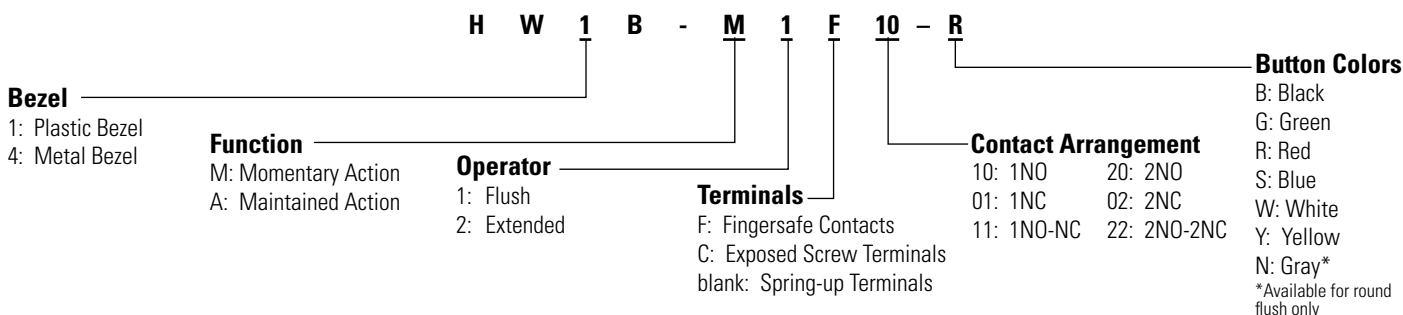

Non-Illuminated Round Pushbuttons (Replacement Parts)



Contact Blocks

Style	Contacts	1NO	1NC
	Standard Fingersafe (IP20)	HW-F10	HW-F01
		HW-F10R (early make)	HW-F01R (late break)
	Spring-Up Terminal	HW-G10	HW-G01
		HW-G10R (early make)	HW-G01R (late break)
	Exposed Screw Terminal	HW-C10	HW-C01
		HW-C10R (early make)	HW-C01R (late break)
	Dummy Block	TW-DB	

Contact Block Mounting Adaptor

Style	Part Number
	HW-CB2C

- 1. Used to mount contact blocks to operator.
- 2. IDEC strongly recommends using the safety lever lock to prevent heavy vibration or maintenance personnel from inadvertently unlocking contacts.

Anti-Rotation Ring

Style	Part Number
	HW9Z-RL

Use with notched panel cutout to prevent unit rotation.

Operators

Style	Plastic Bezel	Metal Bezel
	Momentary	HW1B-M0 HW4B-M0
	Maintained	HW1B-A0 HW4B-A0

Safety Lever Lock

Style	Part Number
	HW9Z-LS

Buttons

Style	Part Number
Round Flush	HW1A-B1-Ⓢ
Round Extended	HW1A-B2-Ⓢ

1. In place of Ⓢ, specify the Button Color Code from table.

Ⓢ Button Color Code

Color	Code	Color	Code
Black	B	White	W
Green	G	Yellow	Y
Red	R	Gray	N*
Blue	S		

*Gray available for round flush only.

Non-Illuminated Mushroom Head Pushbuttons (Assembled)



Function	Contacts	ø29mm Mushroom Head		ø40mm Mushroom Head	
		Plastic Bezel	Metal Bezel	Plastic Bezel	Metal Bezel
Momentary	<i>Operator Only</i>	HW1B-M3-①	HW4B-M3-①	HW1B-M4-①	HW4B-M4-①
	1NO	HW1B-M3F10-①	HW4B-M3F10-①	HW1B-M4F10-①	HW4B-M4F10-①
	1NC	HW1B-M3F01-①	HW4B-M3F01-①	HW1B-M4F01-①	HW4B-M4F01-①
	1NO-1NC	HW1B-M3F11-①	HW4B-M3F11-①	HW1B-M4F11-①	HW4B-M4F11-①
	2NO	HW1B-M3F20-①	HW4B-M3F20-①	HW1B-M4F20-①	HW4B-M4F20-①
	2NC	HW1B-M3F02-①	HW4B-M3F02-①	HW1B-M4F02-①	HW4B-M4F02-①
	2NO-2NC	HW1B-M3F22-①	HW4B-M3F22-①	HW1B-M4F22-①	HW4B-M4F22-①
Maintained	<i>Operator Only</i>	HW1B-A3-①	HW4B-A3-①	HW1B-A4-①	HW4B-A4-①
	1NO	HW1B-A3F10-①	HW4B-A3F10-①	HW1B-A4F10-①	HW4B-A4F10-①
	1NC	HW1B-A3F01-①	HW4B-A3F01-①	HW1B-A4F01-①	HW4B-A4F01-①
	1NO-1NC	HW1B-A3F11-①	HW4B-A3F11-①	HW1B-A4F11-①	HW4B-A4F11-①
	2NO	HW1B-A3F20-①	HW4B-A3F20-①	HW1B-A4F20-①	HW4B-A4F20-①
	2NC	HW1B-A3F02-①	HW4B-A3F02-①	HW1B-A4F02-①	HW4B-A4F02-①
	2NO-2NC	HW1B-A3F22-①	HW4B-A3F22-①	HW1B-A4F22-①	HW4B-A4F22-①



① Button Color Code

Color	Code
Black	B
Green	G
Red	R
Blue	S
White	W
Yellow	Y



1. In place of ①, specify the Button Color Code from table.
2. *60mm mushroom available only in red, green, black, and yellow.
3. For nameplates and accessories, see page 596 and 599.
4. For dimensions, see page 601.
5. For contact assembly part numbers, see page 600.
6. All assembled part numbers in catalog include standard fingersafe (HW-F...) contacts.
7. Assembled units with spring-up terminals (HW-G...) can be ordered by removing an "F" from the part number (Ex. HW1B-M1F11-R becomes HW1B-M111-R).
8. Units with exposed screw terminals (HW-C...) must be ordered as sub-components.
9. Operator only models include operator plus button.
10. Additional contact configurations available (up to 6 total contacts).

Function	Contacts	ø60mm Mushroom Head
		Plastic Bezel
Momentary	<i>Operator Only</i>	HW1B-M5-①*
	1NO	HW1B-M5F10-①*
	1NC	HW1B-M5F01-①*
	1NO-1NC	HW1B-M5F11-①*
	2NO	HW1B-M5F20-①*
	2NC	HW1B-M5F02-①*
	2NO-2NC	HW1B-M5F22-①*

Part Number Structure

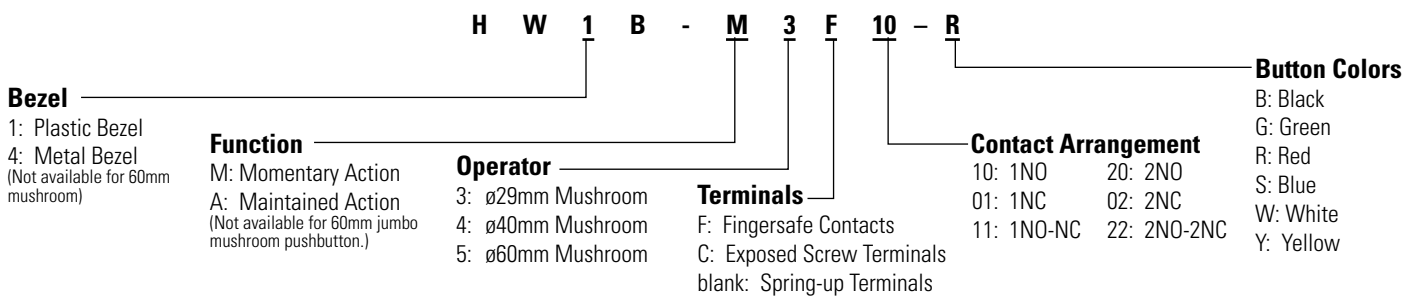

Non-Illuminated Mushroom Head Pushbuttons (Replacement Parts)

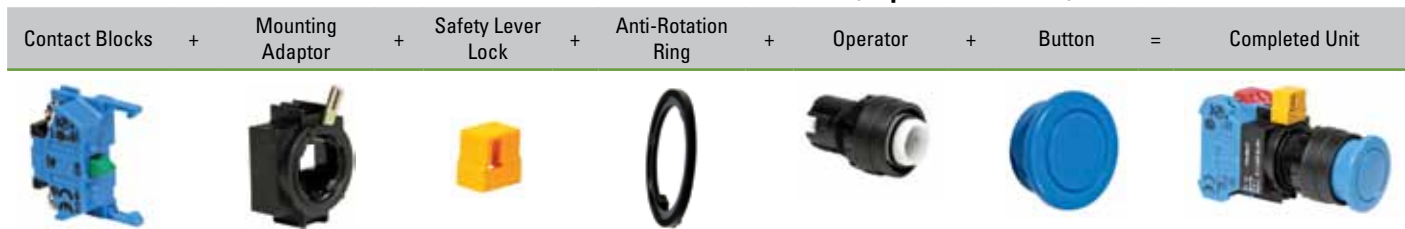

Contact Blocks

Style	Contacts	1NO	1NC
	Standard Fingersafe (IP20)	HW-F10	HW-F01
		HW-F10R (early make)	HW-F01R (late break)
	Spring-Up Terminal	HW-G10	HW-G01
		HW-G10R (early make)	HW-G01R (late break)
	Exposed Screw Terminal	HW-C10	HW-C01
		HW-C10R (early make)	HW-C01R (late break)
	Dummy Block	TW-DB	

Contact Block Mounting Adaptor

Style	Part Number
	HW-CB2C

- 1. Used to mount contact blocks to operator.
- 2. IDEC strongly recommends using the safety lever lock to prevent heavy vibration or maintenance personnel from inadvertently unlocking contacts.

Safety Lever Lock

Style	Part Number
	HW9Z-LS

Anti-Rotation Ring

Appearance	Part Number
	HW9Z-RL

Operators

Style	Plastic Bezel	Metal Bezel	
ø29mm Mushroom ø40mm Mushroom	Momentary	HW1B-M0L	HW4B-M0L
	Maintained	HW1B-A0L	HW4B-A0L
ø60mm Jumbo Mushroom	Momentary	HW1B-M5-⊙*	-

- 1. *60mm mushroom operator includes non-removable button (available in red, black, green and yellow only).
- 2. For nameplates and accessories, see page 596 and 599.
- 3. For dimensions, see page 601.

Buttons

Style	Part Number
ø29mm Mushroom Cap	HW1A-B3-⊙
ø40mm Mushroom Cap	HW1A-B4-⊙

- 1. In place of ⊙, specify the Button Color Code from table.

⊙ Button Color Code

Color	Code	Color	Code
Black	B	Blue	S
Green	G	White	W
Red	R	Yellow	Y

- HW1B-M5 available only in black, red, green and yellow.

Non-Illuminated Square Pushbuttons (Assembled)



Function	Contacts	Square Flush	Square Extended
		Plastic Bezel	Plastic Bezel
Momentary	<i>Operator Only</i>	HW2B-M1-①	HW2B-M2-①
	1NO	HW2B-M1F10-①	HW2B-M2F10-①
	1NC	HW2B-M1F01-①	HW2B-M2F01-①
	1NO-1NC	HW2B-M1F11-①	HW2B-M2F11-①
	2NO	HW2B-M1F20-①	HW2B-M2F20-①
	2NC	HW2B-M1F02-①	HW2B-M2F02-①
	2NO-2NC	HW2B-M1F22-①	HW2B-M2F22-①
Maintained	<i>Operator Only</i>	HW2B-A1-①	HW2B-A2-①
	1NO	HW2B-A1F10-①	HW2B-A2F10-①
	1NC	HW2B-A1F01-①	HW2B-A2F01-①
	1NO-1NC	HW2B-A1F11-①	HW2B-A2F11-①
	2NO	HW2B-A1F20-①	HW2B-A2F20-①
	2NC	HW2B-A1F02-①	HW2B-A2F02-①
	2NO-2NC	HW2B-A1F22-①	HW2B-A2F22-①

① Button Color Code

Color	Code
Black	B
Green	G
Red	R
Blue	S
White	W
Yellow	Y



1. In place of ①, specify the Button Color Code from table.
2. For nameplates and accessories, see page 596 and 599.
3. For dimensions, see page 601.
4. For contact assembly part numbers, see page 600.
5. Square pushbuttons available in plastic bezel only.
6. All assembled part numbers in catalog include standard fingersafe (HW-F...) contacts.
7. Assembled units with spring-up terminals (HW-G...) can be ordered by removing an "F" from the part number (Ex. HW2B-M1F11-R becomes HW1B-M111-R).
8. Units with exposed screw terminals (HW-C...) must be ordered as sub-components.
9. Operator only model includes operator and button.
10. Additional contact configurations available (up to 6 total contacts).

Part Number Structure

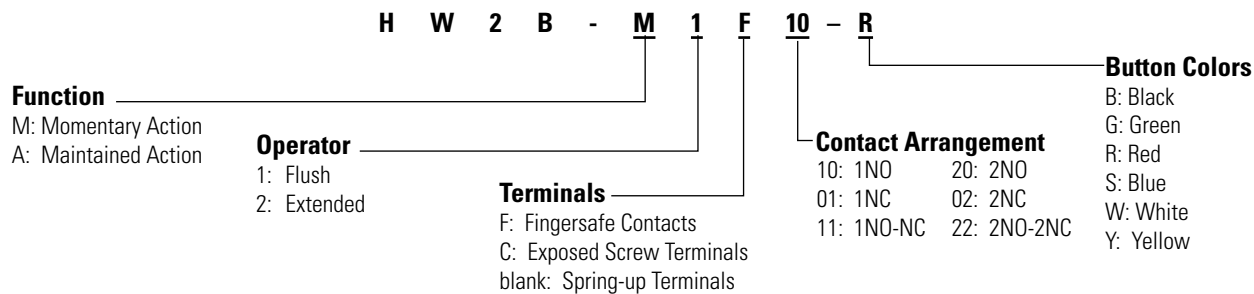

Non-Illuminated Square Pushbuttons (Replacement Parts)

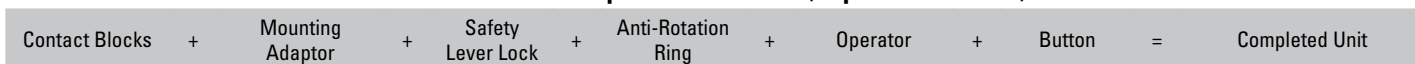

Contact Blocks

Style	Contacts	1NO	1NC
	Standard Fingersafe (IP20)	HW-F10	HW-F01
		HW-F10R (early make)	HW-F01R (late break)
	Spring-Up Terminal	HW-G10	HW-G01
		HW-G10R (early make)	HW-G01R (late break)
	Exposed Screw Terminal	HW-C10	HW-C01
		HW-C10R (early make)	HW-C01R (late break)
	Dummy Block	TW-DB	

Contact Block Mounting Adaptor

Style	Part Number
	HW-CB2C

- 1. Used to mount contact blocks to operator.
- 2. IDEC strongly recommends using the safety lever lock to prevent heavy vibration or maintenance personnel from inadvertently unlocking contacts.

Safety Lever Lock

Style	Part Number
	HW9Z-LS

Anti-Rotation Ring

Appearance	Part Number
	HW9Z-RL

- Use with notched panel cutout to prevent unit rotation.

Operators

Style	Plastic Bezel
Square Flush Extended 	Momentary HW2B-M0
	Maintained HW2B-A0

- 2. For nameplates and accessories, see pages 596 and 599.
- 3. For dimensions, see page 601.

Buttons

Style	Part Number
Square Flush 	HW2A-B1-Ⓢ
Square Extended 	HW2A-B2-Ⓢ

- 1. In place of Ⓢ, specify the Button Color Code from table.

Ⓢ Button Color Code

Color	Code	Color	Code
Black	B	Blue	S
Green	G	White	W
Red	R	Yellow	Y

Non-Illuminated E-Stop Pushbuttons (Assembled)



Contacts	Ø29mm Head Pushlock Turn Reset		Ø40mm Head Pushlock Turn Reset	
	Plastic Bezel	Metal Bezel	Plastic Bezel	Metal Bezel
<i>Operator Only</i>	HW1B-V3 Ⓞ†	HW4B-V3 Ⓞ†	HW1B-V4 Ⓞ†	HW4B-V4 Ⓞ†
1NO	HW1B-V3F10-Ⓞ†	HW4B-V3F10-Ⓞ†	HW1B-V4F10-Ⓞ†	HW4B-V4F10-Ⓞ†
1NC	HW1B-V3F01-Ⓞ†	HW4B-V3F01-Ⓞ†	HW1B-V4F01-Ⓞ†	HW4B-V4F01-Ⓞ†
1NO-1NC	HW1B-V3F11-Ⓞ†	HW4B-V3F11-Ⓞ†	HW1B-V4F11-Ⓞ†	HW4B-V4F11-Ⓞ†
2NO	HW1B-V3F20-Ⓞ†	HW4B-V3F20-Ⓞ†	HW1B-V4F20-Ⓞ†	HW4B-V4F20-Ⓞ†
2NC	HW1B-V3F02-Ⓞ†	HW4B-V3F02-Ⓞ†	HW1B-V4F02-Ⓞ†	HW4B-V4F02-Ⓞ†



Contacts	Ø40mm Head EMO Pushlock Turn Reset		Ø40mm Head Pushlock Key Reset	
	Plastic Bezel	Metal Bezel	Plastic Bezel	Metal Bezel
<i>Operator Only</i>	HW1B-V4R-EMO-2 *	HW4B-V4R-EMO-2 *	HW1B-X4R *	HW4B-X4R *
1NO	HW1B-V4F10-R-EMO-2*	HW4B-V4F10-R-EMO-2*	HW1B-X4F10-R*	HW4B-X4F10-R*
1NC	HW1B-V4F01-R-EMO-2*	HW4B-V4F01-R-EMO-2*	HW1B-X4F01-R*	HW4B-X4F01-R*
1NO-1NC	HW1B-V4F11-R-EMO-2*	HW4B-V4F11-R-EMO-2*	HW1B-X4F11-R*	HW4B-X4F11-R*
2NO	HW1B-V4F20-R-EMO-2*	HW4B-V4F20-R-EMO-2*	HW1B-X4F20-R*	HW4B-X4F20-R*
2NC	HW1B-V4F02-R-EMO-2*	HW4B-V4F02-R-EMO-2*	HW1B-X4F02-R*	HW4B-X4F02-R*



- * Available in Red only.
- † Available in red or yellow. Insert color code in place of Ⓞ (R: Red, Y: Yellow).
- For accessories, see page 599.
- For dimensions, see page 601.
- For nameplates and shrouds, see page 600.
- For contact assembly part numbers, see page 600.
- All HW series E-stops comply with EN60947-5-5, the IEC "E-Stop Addendum to the Low Voltage Directive," this includes "tamper proof" operation whereby a change of contact state is not possible by "teasing" or "floating" the operator.
- All assembled part numbers in catalog include standard fingersafe (HW-F...) contacts.
- Assembled units with spring-up terminals (HW-G...) can be ordered by removing an "F" from the part number (Ex. HW1B-M1F11-R becomes HW1B-M111-R).
- Units with exposed screw terminals (HW-C...) must be ordered as sub-components.
- Operator only models include operator and button.
- Additional contact configurations available (up to 6 total contacts).

Contacts	ø60mm Head Pushlock Turn Reset	
	Plastic Bezel	
<i>Operator Only</i>	HW1B-V5R *	
1NO	HW1B-V5F10-R*	
1NC	HW1B-V5F01-R*	
1NO-1NC	HW1B-V5F11-R*	
2NO	HW1B-V5F20-R*	
2NC	HW1B-V5F02-R*	

Part Number Structure

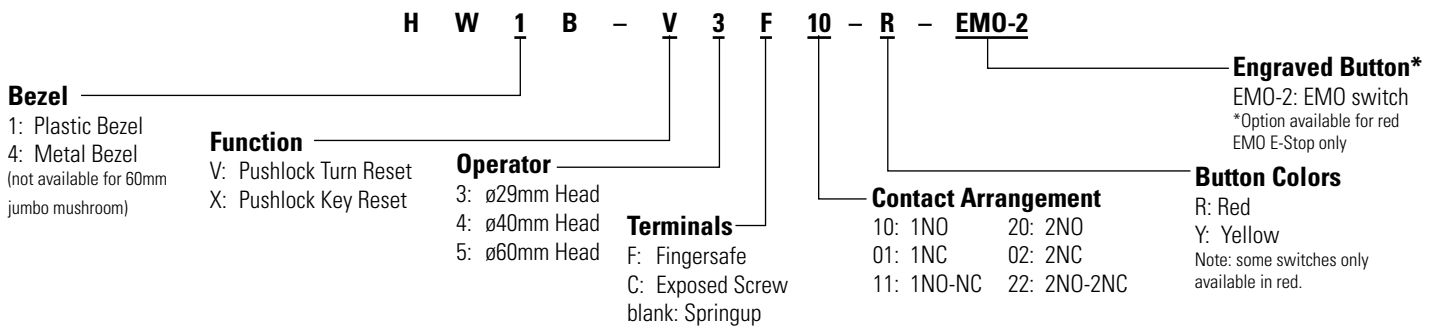

Non-Illuminated E-Stop Pushbuttons (Replacement Parts)

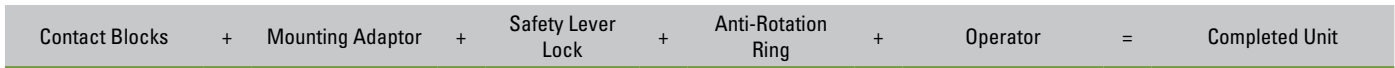

Contact Blocks

Style	Contacts	1NO	1NC
	Standard Fingersafe (IP20)	HW-F10	HW-F01
		HW-F10R (early make)	HW-F01R (late break)
	Spring-Up Terminal	HW-G10	HW-G01
		HW-G10R (early make)	HW-G01R (late break)
	Exposed Screw Terminal	HW-C10	HW-C01
		HW-C10R (early make)	HW-C01R (late break)
	Dummy Block	TW-DB	

Safety Lever Lock

Style	Part Number
	HW9Z-LS

Anti-Rotation Ring

Appearance	Part Number
	HW9Z-RL

Use with notched panel cutout to prevent unit rotation.

Operators

Style	Plastic		Metal
ø29mm Head Pushlock Turn Reset 	red	HW1B-V3R	HW4B-V3R
	yellow	HW1B-V3Y	HW4B-V3Y
ø40mm Head Pushlock Turn Reset 	red	HW1B-V4R	HW4B-V4R
	yellow	HW1B-V4Y	HW4B-V4Y
ø40mm Head EMO Pushlock Turn Reset* 		HW1B-V4R-EMO-2	HW4B-V4R-EMO-2
ø40mm Head Pushlock Key Reset* 		HW1B-X4R	HW4B-X4R
ø60mm Head Pushlock Turn Reset* 		HW1B-V5R	-

1. *Available in red only.
2. All E-Stop buttons are not removable from the operator.

Contact Block Mounting Adaptor

Style	Part Number
	HW-CB2C

- 1. Used to mount contact blocks to operator.
- 2. IDEC strongly recommends using the safety lever lock to prevent heavy vibration or maintenance personnel from inadvertently unlocking contacts.

Push Pull & Unibody E-Stop Pushbuttons (Assembled)



Contacts	ø40mm Head Push-Pull	
	Plastic Bezel	Metal Bezel
<i>Operator Only (Red)</i>	<i>HW1B-Y2R</i>	<i>HW4B-Y2R</i>
<i>Operator Only (Yellow)</i>	<i>HW1B-Y2Y</i>	<i>HW4B-Y2Y</i>
1NO	HW1B-Y2F10-①†	HW4B-Y2F10-①†
1NC	HW1B-Y2F01-①†	HW4B-Y2F01-①†
1NO-1NC	HW1B-Y2F11-①†	HW4B-Y2F11-①†
2NC	HW1B-Y2F02-①†	HW4B-Y2F02-①†
2NO	HW1B-Y2F20-①†	HW4B-Y2F20-①†

Contacts	ø40mm Unibody Pushlock Turn Reset*
	Plastic Bezel
1NO-1NC	HW1E-BV4F11-R
2NC	HW1E-BV4F02-R
1NO-2NC	HW1E-BV412R-TK2093-1



Contacts	Unibody Illuminated E-Stops*	
	LED	Incandescent
1NO-1NC	HW1E-LV4F11QD-R-③	HW1E-LV4F11Q-R-③
2NC	HW1E-LV4F02QD-R-③	HW1E-LV4F02Q-R-③
2NC (with push-on illumination)	HW1E-TV4F02QD-R-③	HW1E-TV4F11Q-R-③
1NO-1NC (with push-on illumination)	HW1E-TV4F11QD-R-③	HW1E-TV4F02Q-R-③

③ Full Voltage Code

Voltage	Code
6VAC/DC	6V
12VAC/DC	12V
24VAC/DC	24V
120V AC*	120V
240V AC*	240V

Terminal Numbering

(Unibody only)

Models	Terminal Number
1NO-1NC	NO = 13/14, NC = 11/12
2NC	NC = 11/12, NC = 21/22
HW1E-L HW1E-T	Lamp + = X2, Lamp - = X1



*LED only.



- * Available in Red only.
- † Available in red or yellow. Insert color code in place of ① (R: Red, Y: Yellow).
- In place of ③, specify Full Voltage Code.
- With single unit construction, the positive action contacts are integrated in the body of the switch. This provides an extra degree of safety and reliability for critical emergency stop functions.
- In the illuminated version, the light is independent of the switch action (except push-on LED model).
- For accessories, see page 599.
- For dimensions, see page 601.
- For nameplates and shrouds, see page 599.
- For contact assembly part numbers, see page 599.
- All HW Series E-Stop operators include non-removable color caps.
- All HW series E-Stops comply with EN60947-5-5, the IEC "E-Stop Addendum to the Low Voltage Directive," this includes "tamper proof" operation whereby a change of contact state is not possible by "teasing" or "floating" the operator.
- All HW series E-Stop switches comply with SEMI S2 standards.
- All assembled part numbers in catalog include standard fingersafe (HW-F...) contacts.
- Assembled units with spring-up terminals (HW-G...) can be ordered by removing an "F" from the part number (Ex. HW1B-M1F11-R becomes HW1B-M111-R).
- Units with exposed screw terminals (HW-C...) must be ordered as sub-components.
- Additional contact configurations available (up to 6 total contacts).

Part Number Structure

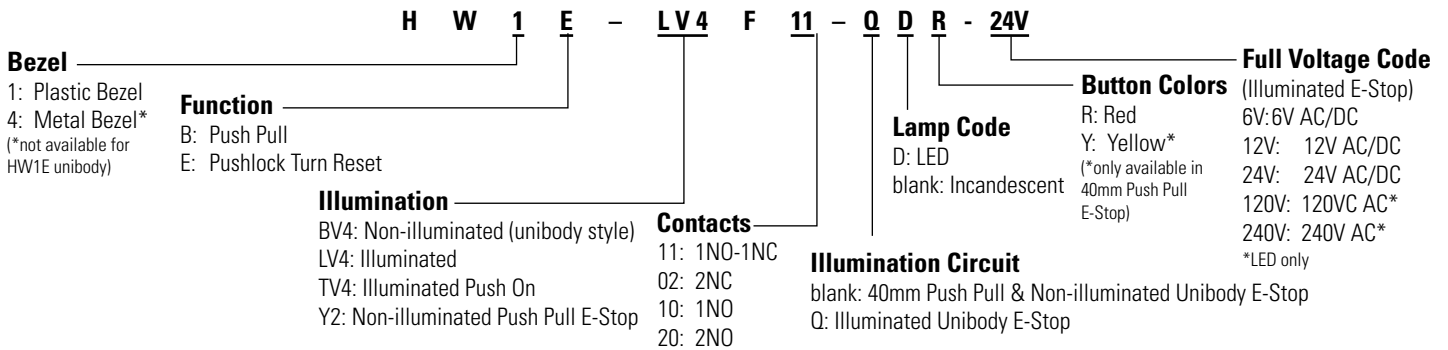

Illuminated & Non-Illuminated E-Stop Pushbuttons (Replacement Parts)

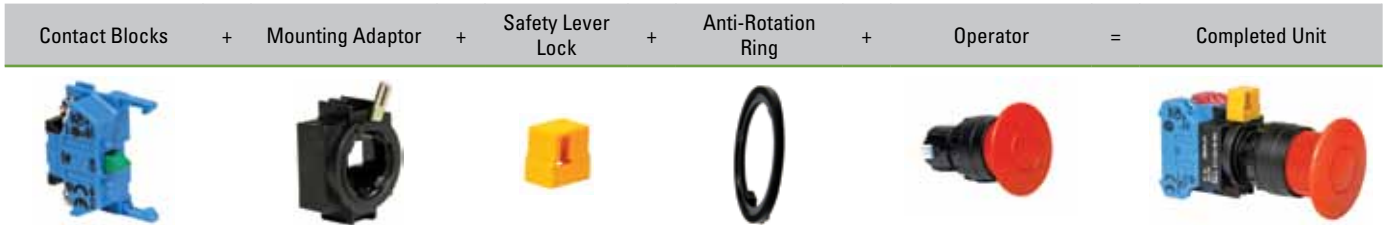

Contact Blocks

Style	Contacts	1NO	1NC
	Standard Fingersafe (IP20)	HW-F10	HW-F01
		HW-F10R (early make)	HW-F01R (late break)
	Spring-Up Terminal	HW-G10	HW-G01
		HW-G10R (early make)	HW-G01R (late break)
	Exposed Screw Terminal	HW-C10	HW-C01
		HW-C10R (early make)	HW-C01R (late break)
	Dummy Block	TW-DB	

- 1. There are no replacement parts for the HW1E unibody E-Stop.
- 2. For illuminated unibody E-Stop, see page 600 for replacement lens.

Contact Block Mounting Adaptor

Style	Part Number
	HW-CB2C

- 1. Used to mount contact blocks to operator.
- 2. IDEC strongly recommends using the safety lever lock to prevent heavy vibration or maintenance personnel from inadvertently unlocking contacts.

Safety Lever Lock

Style	Part Number
	HW9Z-LS

Anti-Rotation Ring

Appearance	Part Number
	HW9Z-RL

- Use with notched panel cutout to prevent unit rotation.

Operators

Style	Part Number		
ø40mm Head Push-Pull	Plastic	red	HW1B-Y2R
	Metal	red	HW4B-Y2R
	Plastic	yellow	HW1B-Y2Y
	Metal	yellow	HW4B-Y2Y

- All E-Stop Buttons are not removable from the operator.

E-Stop Stations



	29mm Pushlock Turn Reset		40mm Pushlock Turn Reset	
Contacts	Plastic Bezel	Metal Bezel	Plastic Bezel	Metal Bezel
1NO-1NC	FB1W-HW1B-V311R	FB1W-HW4B-V311R	FB1W-HW1B-V411R	FB1W-HW4B-V411R
2NC	FB1W-HW1B-V302R	FB1W-HW4B-V302R	FB1W-HW1B-V402R	FB1W-HW4B-V402R



	40mm Push-Pull Reset		40mm Pushlock Key Reset	
Contacts	Plastic Bezel	Metal Bezel	Plastic Bezel	Metal Bezel
1NO-1NC	FB1W-HW1B-Y211R	FB1W-HW4B-Y211R	FB1W-HW1B-X411R	FB1W-HW4B-X411R
2NC	FB1W-HW1B-Y202R	FB1W-HW4B-Y202R	FB1W-HW1B-X402R	FB1W-HW4B-X402R



	40mm EMO Pushlock Turn Reset	
Contacts	Plastic Bezel	Metal Bezel
1NO-1NC	FB1W-HW1B-V411R-EMO-2	FB1W-HW4B-V411R-EMO-2
2NC	FB1W-HW1B-V402R-EMO-2	FB1W-HW4B-V402R-EMO-2

- 1. Maximum of two contact blocks.
- 2. Box is supplied with yellow top and black bottom only.

Jumbo Dome Pilot Lights (Assembled)



Plastic Bezel

Jumbo Dome	LED	Operator Only	HW1P-5Q0
		Full Voltage 24V AC/DC	HW1P-5Q4-Ⓢ
	Incandescent	Operator Only	HW1P-5Q7*
		Full Voltage 24V AC/DC	HW1P-5Q7-Ⓢ

Actual Size



1. In place of Ⓢ, specify the Lens/LED Color Code.
2. *Incandescent operator comes with bulb.
3. Available with spring-up terminals in 24V only.
4. For nameplates and accessories, see page 596 and 599.
5. For dimensions, see page 601.

Ⓢ Lens/LED Color Code

Color	Code
Amber	A
Green	G
Red	R
Blue	S
White	W
Yellow	Y



Jumbo Dome Replacement Parts

Item	Appearance	Description	Part Number
Lens		Polycarbonate Lens	HW1A-P5Ⓢ
LED Diffusing Lens*			HW9Z-PP5C
LED Lamps		LED Lamp	LSTDB-2Ⓢ



1. In place of Ⓢ, specify the Lens/LED Color Code.
2. *Diffusing lens for LED models only.
3. Use white LED for yellow lens.

Lamp Ratings

	Part Number	Operating Voltage	Rated Current	Power Consumption
LED	LSTDB-2	24V AC/DC ±10%	15mA	0.36W
Incandescent	LSB-2		150mA	3.6W



Pilot Lights (Assembled)



		Round Flush		Dome	
		Plastic Bezel	Metal Bezel	Plastic Bezel	Metal Bezel
<i>Operator Only</i>		HW1P-1FQ0-②	HW4P-1FQ0-②	HW1P-2FQ0-②	HW4P-2FQ0-②
Full Voltage		HW1P-1FQ④-②-③	HW4P-1FQ④-②-③	HW1P-2FQ④-②-③	HW4P-2FQ④-②-③
Transformer	120V AC	HW1P-1FH2④-②	HW4P-1FH2④-②	HW1P-2FH2④-②	HW4P-2FH2④-②
	240V AC	HW1P-1FM4④-②	HW4P-1FM4④-②	HW1P-2FM4④-②	HW4P-2FM4④-②
	480V AC	HW1P-1FT8④-②	HW4P-1FT8④-②	HW1P-2FT8④-②	HW4P-2FT8④-②
DC-DC Converter*	110V DC	HW1P-1D2D-②	—	HW1P-2D2D-②	—



		Square Flush	
		Plastic Bezel	Metal Bezel
<i>Operator Only</i>		HW2P-1FQ0-②	
Full Voltage		HW2P-1FQ④-②-③	
Transformer	120V AC	HW2P-1FH2④-②	
	240V AC	HW2P-1FM4④-②	
	480V AC	HW2P-1FT8④-②	
DC-DC Converter*	110V DC	HW2P-1D2D-②	

② Lens/LED Color Code

Color	Code
Amber	A
Green	G
Red	R
Blue	S
White	W
Yellow	Y

③ Full Voltage Code

Voltage	Code
6VAC/DC	6V
12VAC/DC	12V
24VAC/DC	24V
120V AC (LED only)	120V
240V AC (LED only)	240V

④ Lamp Type Code

Lamp	Code
Incandescent	Blank
LED	D



1. In place of ②, specify the Lens/LED Color Code from table below.
2. In place of ③ specify the Full Voltage Code from table below.
3. In place of ④ specify Lamp Type Code from table below.
4. *DC-DC convertor voltage input from 90-140V DC, comes with spring-up terminals only.
5. DC-DC converter models with LED lamps only.
6. For nameplates and accessories, see page 596 and 599.
7. For dimensions, see page 601.
8. **Pilot lights do not come with anti-rotation ring.**
9. Operator models come with operator and lens.
10. **Yellow pilot light comes with white LED.**

Part Number Structure

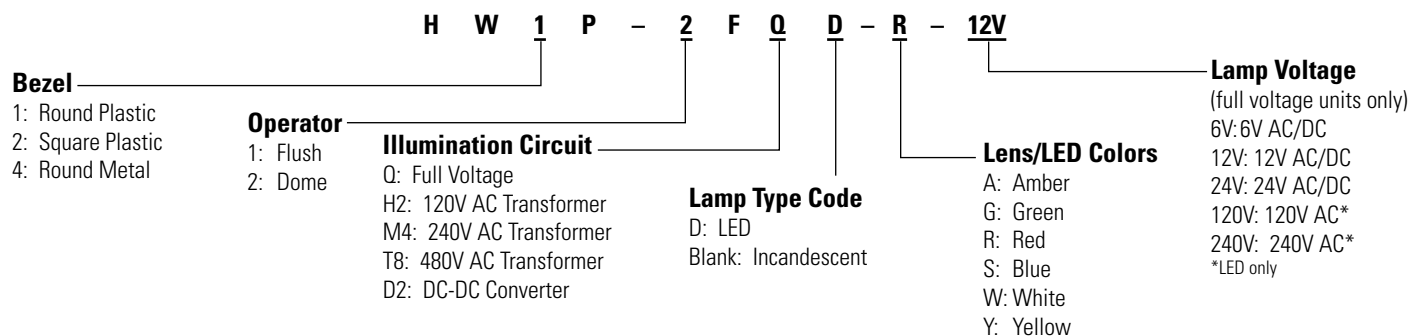

Pilot Lights (Replacement Parts)

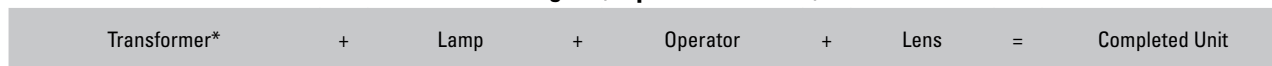

(not applicable for full voltage units)

Transformer Units

Style	Voltage	Part Number
LED/Incandescent 	120V AC	HW-FH20 HW-MH20*
	240V AC	HW-FM40 HW-MM40*
	480V AC	HW-FT80 HW-RT80*
	110V DC**	HW-RD0*

(6V secondary voltage)

- *With spring-up terminals - to use spring-up terminal type, must use transformer type operator designed for spring-up transformer.
- ** DC-DC converter voltage input from 90-140V DC.

Lamps

Style	Voltage	Part Number
LED 	6V AC/DC	LSTD-6Ⓞ
	12V AC/DC	LSTD-1Ⓞ
	24V AC/DC	LSTD-2Ⓞ
	120V AC	LSTD-H2Ⓞ
Incandescent 	240V AC	LSTD-M4Ⓞ
	6V AC/DC	IS-6
	12V AC/DC	IS-12
	24V AC/DC	IS-24

- In place of Ⓞ, specify the LED Color Code.
- The LED contains a current-limiting resistor and reverse polarity protection diodes.

LED Color Code

Color	Code	Color	Code
Amber	A	Blue	S
Green	G	White	W
Red	R		

For yellow lens use white LED.

Operators

Style	Type	Plastic Bezel	Metal Bezel
Round Flush 	Full Voltage	Standard	HW1P-1FQ0
		Spring-up Terminals	HW1P-1Q0
	Transformer	Standard	HW1P-10
		Spring-up Terminals	HW1P-100
Dome 	Full Voltage	Standard	HW1P-2FQ0
		Spring-up Terminals	HW1P-2Q0
	Transformer	Standard	HW1P-20
		Spring-up Terminals	HW1P-200
Square Flush 	Full Voltage	Standard	HW2P-1FQ0
		Spring-up Terminals	HW2P-1Q0
	Transformer	Standard	HW2P-10
		Spring-up Terminals	HW2P-100

- Transformer type requires separate transformer & lamp. Must select correct transformer bases on standard or spring up terminal type. Use 6V lamps or LEDs.
- Full voltage type only requires lamp.

Lenses

Style	Part Number
Round/Flush 	HW1A-P1-Ⓞ
Dome 	HW1A-P2-Ⓞ
Square/Flush 	HW2A-P1-Ⓞ

In place of Ⓞ, specify the Lens Color Code.

Lens Color Code

Color	Code
Amber	A
Green	G
Red	R
Blue	S
White	W
Yellow	Y

For yellow lens use white LED.

Illuminated Round Pushbuttons (Assembled)



Illuminated Full Voltage Pushbuttons



Contacts	Flush		Extended		Extended w/ Full Shroud	
	Plastic Bezel	Metal Bezel	Plastic Bezel	Metal Bezel	Plastic Bezel	Metal Bezel
Momentary						
<i>Operator Only</i>	<i>HW1L-M1-②</i>	<i>HW4L-M1-②</i>	<i>HW1L-M2-②</i>	<i>HW4L-M2-②</i>	<i>HW1L-MF2-②</i>	<i>HW4L-MF2-②</i>
1NO	HW1L-M1F10Q④-②-③	HW4L-M1F10Q④-②-③	HW1L-M2F10Q④-②-③	HW4L-M2F10Q④-②-③	HW1L-MF2F10Q④-②-③	HW4L-MF2F10Q④-②-③
1NC	HW1L-M1F01Q④-②-③	HW4L-M1F01Q④-②-③	HW1L-M2F01Q④-②-③	HW4L-M2F01Q④-②-③	HW1L-MF2F01Q④-②-③	HW4L-MF2F01Q④-②-③
1NO-1NC	HW1L-M1F11Q④-②-③	HW4L-M1F11Q④-②-③	HW1L-M2F11Q④-②-③	HW4L-M2F11Q④-②-③	HW1L-MF2F11Q④-②-③	HW4L-MF2F11Q④-②-③
2NO	HW1L-M1F20Q④-②-③	HW4L-M1F20Q④-②-③	HW1L-M2F20Q④-②-③	HW4L-M2F20Q④-②-③	HW1L-MF2F20Q④-②-③	HW4L-MF2F20Q④-②-③
Maintained						
<i>Operator Only</i>	<i>HW1L-A1-②</i>	<i>HW4L-A1-②</i>	<i>HW1L-A2-②</i>	<i>HW4L-A2-②</i>	<i>HW1L-AF2-②</i>	<i>HW4L-AF2-②</i>
1NO	HW1L-A1F10Q④-②-③	HW4L-A1F10Q④-②-③	HW1L-A2F10Q④-②-③	HW4L-A2F10Q④-②-③	HW1L-AF2F10Q④-②-③	HW4L-AF2F10Q④-②-③
1NC	HW1L-A1F01Q④-②-③	HW4L-A1F01Q④-②-③	HW1L-A2F01Q④-②-③	HW4L-A2F01Q④-②-③	HW1L-AF2F01Q④-②-③	HW4L-AF2F01Q④-②-③
1NO-1NC	HW1L-A1F11Q④-②-③	HW4L-A1F11Q④-②-③	HW1L-A2F11Q④-②-③	HW4L-A2F11Q④-②-③	HW1L-AF2F11Q④-②-③	HW4L-AF2F11Q④-②-③
2NO	HW1L-A1F20Q④-②-③	HW4L-A1F20Q④-②-③	HW1L-A2F20Q④-②-③	HW4L-A2F20Q④-②-③	HW1L-AF2F20Q④-②-③	HW4L-AF2F20Q④-②-③

Illuminated Transformer Pushbuttons



Contacts	Flush		Extended		Extended w/ Full Shroud	
	Plastic Bezel	Metal Bezel	Plastic Bezel	Metal Bezel	Plastic Bezel	Metal Bezel
Momentary						
<i>Operator Only</i>	<i>HW1L-M1-②</i>	<i>HW4L-M1-②</i>	<i>HW1L-M2-②</i>	<i>HW4L-M2-②</i>	<i>HW1L-MF2-②</i>	<i>HW4L-MF2-②</i>
1NO-1NC	HW1L-M1F11③④-②	HW4L-M1F11③④-②	HW1L-M2F11③④-②	HW4L-M2F11③④-②	HW1L-MF2F11③④-②	HW4L-MF2F11③④-②
2NO	HW1L-M1F20③④-②	HW4L-M1F20③④-②	HW1L-M2F20③④-②	HW4L-M2F20③④-②	HW1L-MF2F20③④-②	HW4L-MF2F20③④-②
Maintained						
<i>Operator Only</i>	<i>HW1L-A1-②</i>	<i>HW4L-A1-②</i>	<i>HW1L-A2-②</i>	<i>HW4L-A2-②</i>	<i>HW1L-AF2-②</i>	<i>HW4L-AF2-②</i>
1NO-1NC	HW1L-A1F11③④-②	HW4L-A1F11③④-②	HW1L-A2F11③④-②	HW4L-A2F11③④-②	HW1L-AF2F11③④-②	HW4L-AF2F11③④-②
2NO	HW1L-A1F20③④-②	HW4L-A1F20③④-②	HW1L-A2F20③④-②	HW4L-A2F20③④-②	HW1L-AF2F20③④-②	HW4L-AF2F20③④-②



- In place of ②, specify Lens/LED Color Code from table.
- In place of ③ specify Voltage Code from table.
- In place of ④ specify Lamp Code from table.
- Light independent of switch position.
- For replacement part numbers, see page 567.
- For nameplates and accessories, see page 596 and 599.
- For dimensions, see page 601.
- For contact assembly part numbers, see page 600.
- Full voltage and transformer models use the same operator.
- Additional contact configurations available (up to 6 total contacts).
- Yellow pushbutton comes with white LED.**

② Lens/LED Color Code

Color	Code
Amber	A
Green	G
Red	R
Blue	S
White	W
Yellow	Y



Yellow LED not available. Use white LED for yellow lens.

③ Voltage Code

Full Voltage Models		Transformer Models	
Voltage	Code	Voltage	Code
6V AC/DC	6V	120V AC	H2
12V AC/DC	12V	240V AC	M4
24V AC/DC	24V	480V AC	T8
120V AC (LED only)	120V		
240V AC (LED only)	240V		

④ Lamp Code

Lamp	Code
Incandescent	Blank
LED	D

Part Number Structure

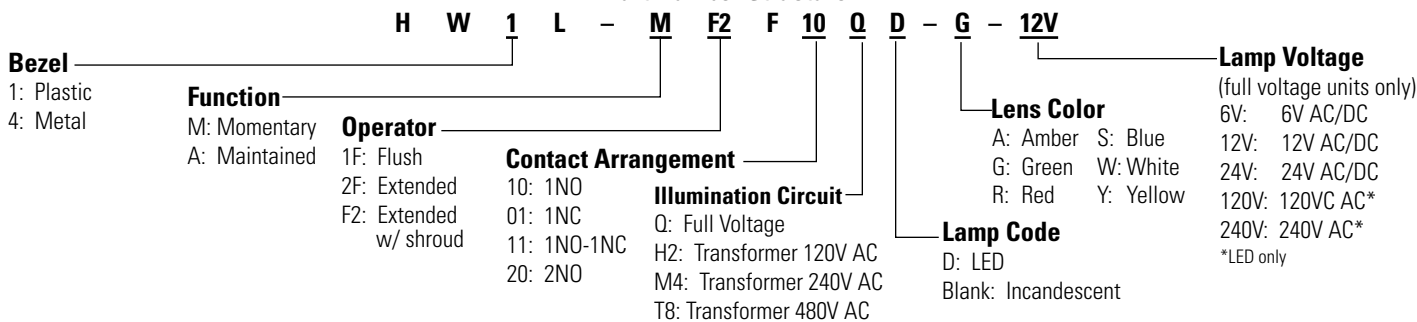

Illuminated Round Pushbuttons (Replacement Parts)

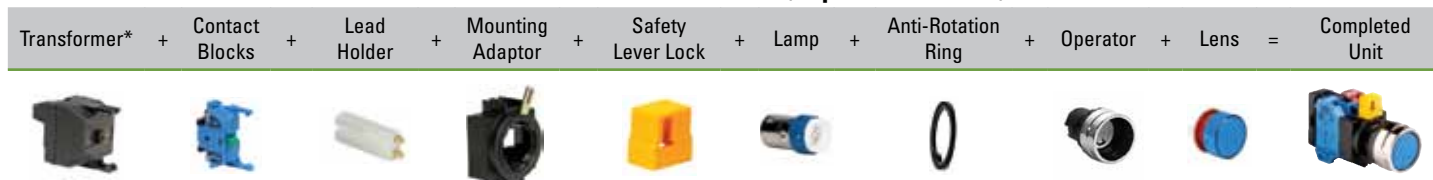

*Transformer not needed with full voltage models.

Lamp Circuit Components

Style	Description	Terminals	Part Number	
	For use with HW-CBL on all illuminated pushbutton units. One required for each deck (pair) of contacts.		HW-LH3	
	For use with odd number of contacts.	Fingersafe	HW-DA1FB	
		Exposed	HW-DA1B	
		Spring Up	HW-GA1	
	For use with even number of contacts.	Fingersafe	TW-DA1FB	
		Exposed	TW-DA1B	
	120VAC 240VAC 480VAC	Fingersafe	TW-F126B TW-F246B TW-F486B	
		Spring Up	HW-T126 HW-T246 HW-L486	
			Exposed	TW-T126B TW-T246B TW-T486B
	120V 240V 480V	Spring Up		HW-T126 HW-T246 HW-L486
				Exposed
	DC-DC Converter	110VDC		

HW-GA1 "Dummy Block with full voltage adaptor" does not require the use of HW-LH3.

Operators

Style		Plastic Bezel	Metal Bezel
	Momentary	HW1L-M0	HW4L-M0
	Maintained	HW1L-A0	HW4L-A0
	Momentary	HW1L-MF0	HW4L-MF0
	Maintained	HW1L-AF0	HW4L-AF0

Contact Blocks

Style	Contacts	1NO	1NC
	Standard Fingersafe (IP20)	HW-F10 HW-F10R (early make)	HW-F01 HW-F01R (late break)
	Spring-Up Terminal	HW-G10 HW-G10R (early make)	HW-G01 HW-G01R (late break)
	Exposed Screw Terminal	HW-C10 HW-C10R (early make)	HW-C01 HW-C01R (late break)

- 1. All assembled part numbers in catalog include standard fingersafe (HW-F..) contacts.
- 2. Assembled units with spring-up terminals (HW-G..) can be ordered by removing an "F" from the part number (Ex. HW1B-M1F11-R becomes HW1B-M111-R).
- 3. Units with exposed screw terminals (HW-C..) must be ordered as sub-components.

Contact Block Mounting Adaptor

Style	Part Number
	HW-CBL

- 1. Used to mount contact blocks to operator (first pair only).
- 2. IDEC strongly recommends using the safety lever lock to prevent heavy vibration or maintenance personnel from inadvertently unlocking contacts.

Safety Lever Lock

Style	Part Number
	HW9Z-LS

Lenses

Style	Part Number
Round Flush	HW1A-L1-Ⓞ
Round Extended	
	HW1A-L2-Ⓞ

In place of Ⓞ, specify the Lens Color Code from previous page.

Anti-Rotation Ring

Appearance	Part Number
	HW9Z-RL

Use with notched panel cutout to prevent unit rotation.

Lamps

Style	Voltage	Part Number
	6V AC/DC	LSTD-6Ⓞ
	12V AC/DC	LSTD-1Ⓞ
	24V AC/DC	LSTD-2Ⓞ
	120V AC	LSTD-H2Ⓞ
	240V AC	LSTD-M4Ⓞ
	6V AC/DC	IS-6
	12V AC/DC	IS-12
	24V AC/DC	IS-24

- 1. In place of Ⓞ, specify the LED Color Code.
- 2. The LED contains a current-limiting resistor and reverse polarity protection diodes.
- 3. Yellow LED not available, use white LED when using yellow lens.

Illuminated Mushroom & Square Pushbuttons (Assembled)



		40mm Mushroom Head			Square Flush
		Contacts	Plastic Bezel	Metal Bezel	Plastic Bezel
Full Voltage	Momentary	<i>Operator Only</i> ¹	HW1L-M4-②	HW4L-M4-②	HW2L-M1-②
		1NO	HW1L-M4F10Q④-②-③	HW4L-M4F10Q④-②-③	HW2L-M1F10Q④-②-③
		1NC	HW1L-M4F01Q④-②-③	HW4L-M4F01Q④-②-③	HW2L-M1F01Q④-②-③
		1NO-1NC	HW1L-M4F11Q④-②-③	HW4L-M4F11Q④-②-③	HW2L-M1F11Q④-②-③
		2NO	HW1L-M4F20Q④-②-③	HW4L-M4F20Q④-②-③	HW2L-M1F20Q④-②-③
	Maintained	<i>Operator Only</i> ¹	HW1L-A4-②	HW4L-A4-②	HW2L-A1-②
		1NO	HW1L-A4F10Q④-②-③	HW4L-A4F10Q④-②-③	HW2L-A1F10Q④-②-③
		1NC	HW1L-A4F01Q④-②-③	HW4L-A4F01Q④-②-③	HW2L-A1F01Q④-②-③
		1NO-1NC	HW1L-A4F11Q④-②-③	HW4L-A4F11Q④-②-③	HW2L-A1F11Q④-②-③
		2NO	HW1L-A4F20Q④-②-③	HW4L-A4F20Q④-②-③	HW2L-A1F20Q④-②-③
Transformer	Momentary	1NO-1NC	HW1L-M4F11③④-②	HW4L-M4F11③④-②	HW2L-M1F11③④-②
		2NO	HW1L-M4F20③④-②	HW4L-M4F20③④-②	HW2L-M1F20③④-②
	Maintained	1NO-1NC	HW1L-A4F11③④-②	HW4L-A4F11③④-②	HW2L-A1F11③④-②
		2NO	HW1L-A4F20③④-②	HW4L-A4F20③④-②	HW2L-A1F20③④-②



- ¹ Full voltage and transformer units use the same operator.
- In place of ②, specify the Lens/LED Color Code from table.
- In place of ③ specify the Voltage Code from table.
- In place of ④ specify Lamp Type Code from table.
- Light independent of switch position
- For nameplates and accessories, see page 596 and 599.
- For dimensions, see page 601.
- For contact assembly part numbers, see page 600.
- Additional contact configurations available (up to 6 total contacts).
- 10. Yellow pushbutton comes with white LED.**

② Lens/LED Color Code

Color	Code
Amber	A
Green	G
Red	R
Blue	S
White	W
Yellow	Y*



- *40mm mushroom lenses not available in yellow.
- Yellow LED not available. Use white LED for yellow lens.

③ Voltage Code

Full Voltage Models		Transformer Models	
Voltage	Code	Voltage	Code
6V AC/DC	6V	120V AC	H2
12V AC/DC	12V	240V AC	M4
24V AC/DC	24V	480V AC	T8
120V AC (LED only)	120V		
240V AC (LED only)	240V		

④ Lamp Code

Lamp	Code
Incandescent	Blank
LED	D

Switches & Pilot Devices

Signaling Lights

Relays & Sockets

Timers

Contactors

Terminal Blocks

Circuit Breakers

Part Number Structure

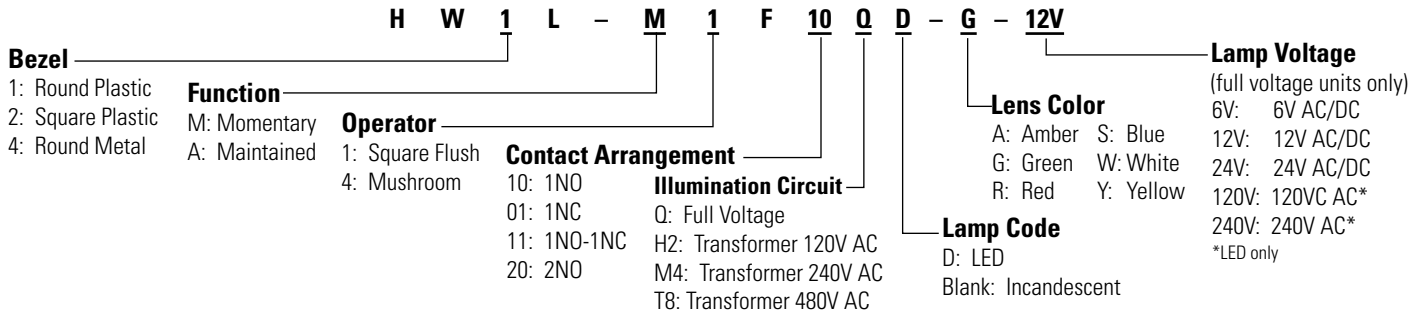

Illuminated Mushroom & Square Pushbuttons (Replacement Parts)



*Transformer not needed with full voltage models.

Lamp Circuit Components

Style	Description	Terminals	Part Number	
	For use with HW-CBL on all illuminated pushbutton units. One required for each deck (pair) of contacts.		HW-LH3	
	For use with odd number of contacts.	Fingersafe	HW-DA1FB	
		Exposed	HW-DA1B	
		Spring Up	HW-GA1	
	For use with even number of contacts.	Fingersafe	TW-DA1FB	
		Exposed	TW-DA1B	
	120VAC 240VAC 480VAC	Fingersafe	TW-F126B TW-F246B TW-F486B	
		Spring Up	HW-T126 HW-T246 HW-L486	
			Exposed	TW-T126B TW-T246B TW-T486B
	120V 240V 480V			
		DC-DC Converter		110VDC

HW-GA1 "Dummy Block with full voltage adaptor" does not require the use of HW-LH3.

Operators

Style	Plastic Bezel	Metal Bezel
ø40mm Mushroom	Momentary	HW1L-MOL HW4L-MOL
	Maintained	HW1L-AOL HW4L-AOL
Square	Momentary	HW2L-M0 -
	Maintained	HW2L-A0 -

Contact Blocks

Style	Contacts	1NO	1NC
	Standard Fingersafe (IP20)	HW-F10 HW-F10R (early make)	HW-F01 HW-F01R (late break)
	Spring-Up Terminal	HW-G10 HW-G10R (early make)	HW-G01 HW-G01R (late break)
	Exposed Screw Terminal	HW-C10 HW-C10R (early make)	HW-C01 HW-C01R (late break)

1. All assembled part numbers in catalog include standard fingersafe (HW-F...) contacts.
 2. Assembled units with spring-up terminals (HW-G...) can be ordered by removing an "F" from the part number (Ex. HW1B-M1F11-R becomes HW1B-M111-R).
 3. Units with exposed screw terminals (HW-C...) must be ordered as sub-components.

Contact Block Mounting Adaptor

Style	Part Number
	HW-CBL

1. Used to mount contact blocks to operator (first pair only).
 2. IDEC strongly recommends using the safety lever lock to prevent heavy vibration or maintenance personnel from inadvertently unlocking contacts.

Safety Lever Lock

Style	Part Number
	HW9Z-LS

Lenses

Style	Part Number
ø40mm Mushroom Lens	ALW4BLU-⊙*
Square Flush	HW2A-L1-⊙

1. In place of ⊙, specify the Lens Color Code.
 2. *Mushroom lens not available in yellow.

Anti-Rotation Ring

Appearance	Part Number
	HW9Z-RL

- Use with notched panel cutout to prevent unit rotation.

Lamps

Style	Voltage	Part Number
	6V AC/DC	LSTD-6⊙
	12V AC/DC	LSTD-1⊙
	24V AC/DC	LSTD-2⊙
	120V AC	LSTD-H2⊙
	240V AC	LSTD-M4⊙
	6V AC/DC	IS-6
	12V AC/DC	IS-12
	24V AC/DC	IS-24

1. In place of ⊙, specify the LED Color Code.
 2. The LED contains a current-limiting resistor and reverse polarity protection diodes.
 3. Yellow LED not available, use white LED when using yellow lens.

Selector Switches 2-Position (Assembled)



2-Position Selector Switches

Contact	Mounting	Operator Position		Handle	Maintained	Spring Return from Right
		L	R			
<i>Operator Only</i>				<i>Knob Lever</i>	<i>HWⓈS-2T HWⓈS-2L</i>	<i>HWⓈS-21T HWⓈS-21L</i>
1NO	1	0	X	Knob Lever	HWⓈS-2TF10 HWⓈS-2LF10	HWⓈS-21TF10 HWⓈS-21LF10
1NO- 1NC	1 2	0 X	X 0	Knob Lever	HWⓈS-2TF11 HWⓈS-2LF11	HWⓈS-21TF11 HWⓈS-21LF11
2NO	1 2	0 0	X X	Knob Lever	HWⓈS-2TF20 HWⓈS-2LF20	HWⓈS-21TF20 HWⓈS-21LF20
2NO- 2NC	1 2 3 4	X 0 X 0	0 X 0 X	Knob Lever	HWⓈS-2TF22 HWⓈS-2LF22	HWⓈS-21TF22 HWⓈS-21LF22



- In place of Ⓢ enter 1 for plastic bezel or 4 for metal bezel.
- For nameplates, see page 596.
- All assembled part numbers in catalog include standard fingersafe (HW-F...) contacts.
- Assembled units with spring-up terminals (HW-G...) can be ordered by removing an "F" from the part number (Ex. HW1B-M1F11-R becomes HW1B-M111-R).
- Units with exposed screw terminals (HW-C...) must be ordered as sub-components.
- Standard color for knob and lever is black.
- Optional colors available for lever type. Must order in components. See next page for part numbers.
- Additional contact configurations available (up to 6 total contacts).
- For Truth Tables see page 608.

Ⓢ Bezel Type

Type	Code
Plastic	1
Metal	4

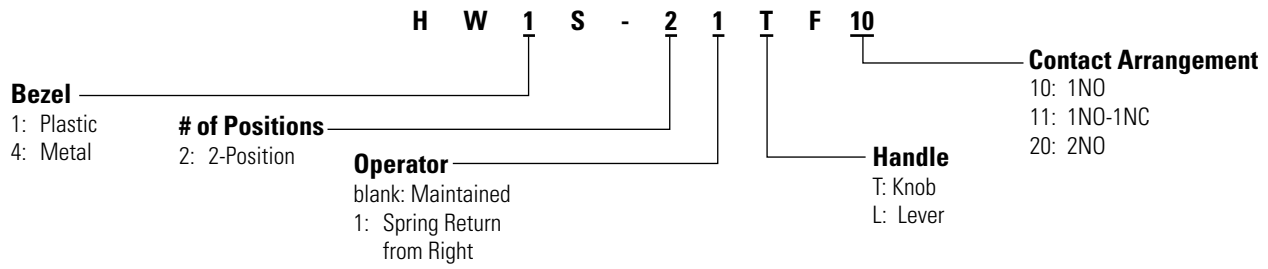

Part Number Structure



Selector Switches 2-Position (Replacement Parts)



Contact Blocks

Style	Contacts	1NO	1NC
	Standard Fingersafe (IP20)	HW-F10	HW-F01
		HW-F10R (early make)	HW-F01R (late break)
	Spring-Up Terminal	HW-G10	HW-G01
		HW-G10R (early make)	HW-G01R (late break)
	Exposed Screw Terminal	HW-C10	HW-C01
		HW-C10R (early make)	HW-C01R (late break)
Dummy Block		TW-DB	

Anti-Rotation Ring

Style	Part Number
	HW9Z-RL

 Use with notched panel cutout to prevent unit rotation.

Operators

Style	Description	Handle	Plastic Bezel	Metal Bezel
	Maintained	Knob	HW1S-2T	HW4S-2T
		Lever	HW1S-2	HW4S-2
	Spring Return from Right	Knob	HW1S-21T	HW4S-21T
		Lever	HW1S-21	HW4S-21

 1. Knob operator comes with black handle.
2. To order lever type, lever and inserts must be ordered separately, along with lever operator. See part numbers below.

Contact Block Mounting Adaptor

Style	Part Number
	HW-CB2C

 1. Used to mount contact blocks to operator (first pair only).
2. IDEC strongly recommends using the safety lever lock to prevent heavy vibration or maintenance personnel from inadvertently unlocking contacts.

Safety Lever Lock

Style	Part Number
	HW9Z-LS

Levers & Inserts

Style	Part Number
	Lever ASWHHL-⓪
	Lever Color Insert TW-HC1-⓪

 Standard lever color is black. Standard insert color is white.

① Handle/Insert Color Code

Color	Code
Black*	B
Blue	S
Green	G
Red	R
Yellow	Y
White†	W

 1. * Lever color inserts not available in black.
2. †Lever not available in white.

Selector Switches 3-Position (Assembled)



3-Position Selector Switches

Contact	Mounting	Operator Position			Handle	Maintained	Spring Return from Right	Spring Return from Left	Spring Return Two-Way
		L	C	R					
Operator Only					<i>Knob Lever</i>	<i>HW⊙S-3T* HW⊙S-3L</i>	<i>HW⊙S-31T HW⊙S-31L</i>	<i>HW⊙S-32T HW⊙S-32L</i>	<i>HW⊙S-33T HW⊙S-33L</i>
1NO-1NC	1	0	X	X	Knob Lever	HW⊙S-3TF11 HW⊙S-3LF11	HW⊙S-31TF11 HW⊙S-31LF11	HW⊙S-32TF11 HW⊙S-32LF11	HW⊙S-33TF11 HW⊙S-33LF11
	2	0	0	X					
2NO	1	X	0	0	Knob Lever	HW⊙S-3TF20 HW⊙S-3LF20	HW⊙S-31TF20 HW⊙S-31LF20	HW⊙S-32TF20 HW⊙S-32LF20	HW⊙S-33TF20 HW⊙S-33LF20
	2	0	0	X					
2NC	1	0	X	X	Knob Lever	HW⊙S-3TF02 HW⊙S-3LF02	HW⊙S-31TF02 HW⊙S-31LF02	HW⊙S-32TF02 HW⊙S-32LF02	HW⊙S-33TF02 HW⊙S-33LF02
	2	X	X	0					
2NO-1NC	1	X	0	0	Knob	HW⊙S-3JTF21N1	-	-	-
	2	0	0	X					
	3	0	X	0					
2NO-2NC	1	X	0	0	Knob	HW⊙S-3TF22	HW⊙S-31TF22	HW⊙S-32TF22	HW⊙S-33TF22
	2	0	0	X					
	3	0	X	X					
	4	X	X	0					
2NO-2NC	1	0	0	X	Knob	HW⊙S-3STF22N9	-	-	-
	2	X	0	0					
	3	X	X	0					
	4	0	0	X					
4NO	1	X	0	0	Knob	HW⊙S-3TF40	HW⊙S-31TF40	HW⊙S-32TF40	HW⊙S-33TF40
	2	0	0	X					
	3	X	0	0					
	4	0	0	X					
4NO	1	X	0	0	Knob	HW⊙S-3STF40N2	-	-	-
	2	0	X	X					
	3	X	0	0					
	4	0	0	X					
4NC	1	0	X	X	Knob	HW⊙S-3TF04	HW⊙S-31TF04	HW⊙S-32TF04	HW⊙S-33TF04
	2	X	X	0					
	3	0	X	X					
	4	X	X	0					

Ⓢ Bezel Type

Type	Code
Plastic	1
Metal	4

- In place of ⊙ enter 1 for plastic bezel or 4 for metal bezel.
- Knob operator includes black knob/lever operator includes black lever.
- * Three position operator is available with three different cams.
HW⊙S-3T: Maintained (standard cam)
HW⊙S-3ST: Maintained (S cam)
HW⊙S-3JT: Maintained (J cam)
- Operator cams are color coded (white=standard cam, red=S cam, black =J cam).
- For nameplates, see page 596.
- For contact assembly part numbers, see page 600.
- All assembled part numbers in catalog include standard fingersafe (HW-F...) contacts.
- Assembled units with spring-up terminals (HW-G...) can be ordered by removing an "F" from the part number (Ex. HW1B-M1F11-R becomes HW1B-M111-R).
- Units with exposed screw terminals (HW-C...) must be ordered as sub-components.
- Standard color for knob and lever is black.
- Optional colors available for lever type. Must order in components. See next page for part numbers.
- Additional contact configurations available (up to 6 total contacts).
- For Truth Tables see page 608.

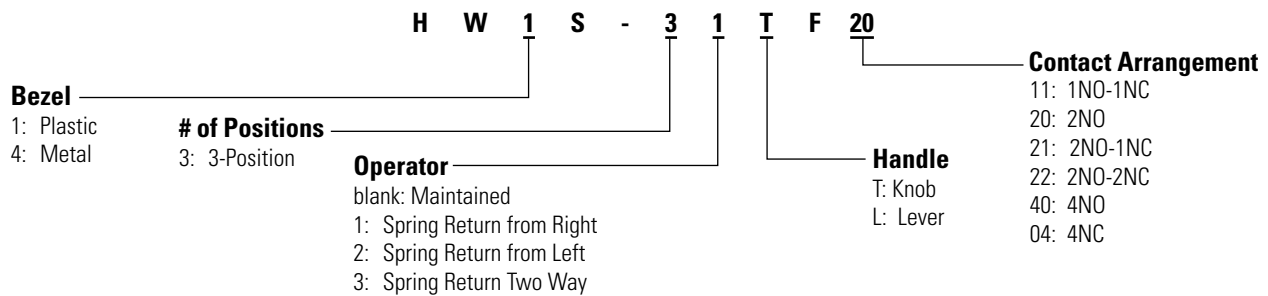

Part Number Structure



Selector Switches 3-Position (Replacement Parts)



Contact Blocks

Style	Contacts	1NO	1NC
	Standard Fingersafe (IP20)	HW-F10	HW-F01
		HW-F10R (early make)	HW-F01R (late break)
	Spring-Up Terminal	HW-G10	HW-G01
		HW-G10R (early make)	HW-G01R (late break)
	Exposed Screw Terminal	HW-C10	HW-C01
		HW-C10R (early make)	HW-C01R (late break)
Dummy Block		TW-DB	

Anti-Rotation Ring

Style	Part Number
	HW9Z-RL

 Use with notched panel cutout to prevent unit rotation.

Operators

Style	Description	Handle	Plastic Bezel	Metal Bezel
	Maintained (standard cam)	Knob	HW1S-3T	HW4S-3T
		Lever	HW1S-3	HW4S-3
	Maintained (S cam)	Knob	HW1S-3ST	HW4S-3ST
		Knob	HW1S-3JT	HW4S-3JT
	Spring Return from Right (standard cam)	Knob	HW1S-31T	HW4S-31T
		Lever	HW1S-31	HW4S-31
	Spring Return from Left (standard cam)	Knob	HW1S-32T	HW4S-32T
		Lever	HW1S-32	HW4S-32
	2-Way Spring Return (standard cam)	Knob	HW1S-33T	HW4S-33T
		Lever	HW1S-33	HW4S-33

-  1. Knob operator comes with black handle.
 2. Three position knob operator is available with three different cams.
 3. Operator cams are color coded (white=standard cam, red=S cam, black=J cam).
 4. To order lever type, lever and inserts must be ordered separately, along with lever operator. See part numbers below.

Contact Block Mounting Adaptor

Style	Part Number
	HW-CB2C

-  1. Used to mount contact blocks to operator (first pair only).
 2. IDEC strongly recommends using the safety lever lock to prevent heavy vibration or maintenance personnel from inadvertently unlocking contacts.

Safety Lever Lock

Style	Part Number
	HW9Z-LS

Levers & Inserts

Style	Part Number
	Lever ASWHHL-①
	Lever Color Insert TW-HC1-①

 Standard lever color is black. Standard insert color is white.

① Handle/Insert Color Code

Color	Code	Color	Code
Black*	B	Red	R
Blue	S	Yellow	Y
Green	G	White [†]	W

-  1. * Lever color inserts not available in black.
 2. [†]Lever not available in white.

Selector Switches 4- & 5-Position (Assembled)



4-Position Selector Switches

Contact	Mounting	Operator Position				Handle	Maintained
		1	2	3	4		
Operator Only						Knob Lever	HW [Ⓢ] S-4T HW [Ⓢ] S-4L
1NO- 2NC	1	X	0	0	0	Knob Lever	HW [Ⓢ] S-4TF12 HW [Ⓢ] S-4LF12
	2	0	X	0	0		
	3	0	0	X	0		
	4	0	0	0	0		
1NO- 3NC	1	0	X	X	X	Knob Lever	HW [Ⓢ] S-4TF13N6 HW [Ⓢ] S-4LF13N6
	2	0	X	0	0		
	3	0	0	X	0		
	4	0	0	0	X		
2NO- 2NC	1	X	0	0	0	Knob Lever	HW [Ⓢ] S-4TF22N3 HW [Ⓢ] S-4LF22N3
	2	0	X	0	0		
	3	0	0	X	0		
	4	0	0	0	X		

5-Position Selector Switch

Contact	Mounting	Operator Position					Handle	Maintained
		1	2	3	4	5		
Operator Only						Knob Lever	HW [Ⓢ] S-5T HW [Ⓢ] S-5L	
2NO- 2NC	1	X	0	0	0	0	Knob Lever	HW [Ⓢ] S-5TF22N3 HW [Ⓢ] S-5LF22N3
	2	0	X	0	0	0		
	3	0	0	0	X	0		
	4	0	0	0	0	X		



- In place of Ⓢ enter 1 for plastic bezel or 4 for metal bezel.
- Knob operator includes black knob/lever operator includes black lever.
- For nameplates, see page 596.
- For contact assembly part numbers, see page 600.
- Five position circuit cannot be made to make five independent contact closures.
- All assembled part numbers in catalog include standard fingersafe (HW-F...) contacts.
- Assembled units with spring-up terminals (HW-G...) can be ordered by removing an "F" from the part number (Ex. HW1B-M1F11-R becomes HW1B-M111-R).
- Units with exposed screw terminals (HW-C...) must be ordered as sub-components.
- Standard color for knob and lever is black.
- Optional colors available for lever type. Must order in components. See next page for part numbers.
- Additional contact configurations available (up to 6 total contacts).
- For Truth Tables see page 608.

Ⓢ Bezel Type

Type	Code
Plastic	1
Metal	4

Part Number Structure

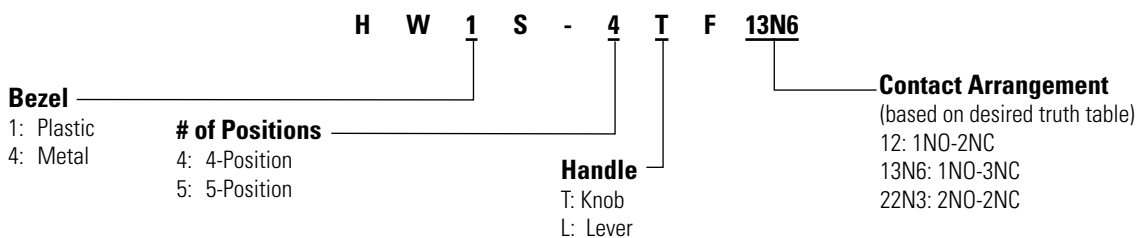

Selector Switches 4- & 5-Position (Replacement Parts)



Contact Blocks

Style	Contacts	1NO	1NC
Standard Fingersafe (IP20)		HW-F10	HW-F01
		HW-F10R (early make)	HW-F01R (late break)
Spring-Up Terminal		HW-G10	HW-G01
		HW-G10R (early make)	HW-G01R (late break)
Exposed Screw Terminal		HW-C10	HW-C01
		HW-C10R (early make)	HW-C01R (late break)
Dummy Block		TW-DB	

Anti-Rotation Ring

Style	Part Number
	HW9Z-RL

Use with notched panel cutout to prevent unit rotation.

Operators

Style	Position	Description	Handle	Plastic Bezel	Metal Bezel
	4	Maintained	Knob	HW1S-4T	HW4S-4T
			Lever	HW1S-4	HW4S-4
	5	Maintained	Knob	HW1S-5T	HW4S-5T
			Lever	HW1S-5	HW4S-5

- 1. Knob operator comes with black handle.
- 2. To order lever type, lever and inserts must be ordered separately, along with lever operator. See part numbers below.

Levers & Inserts

Style	Part Number
	ASWHHL-⓪
	TW-HC1-⓪

Standard lever color is black. Standard insert color is white.

① Handle/Insert Color Code

Color	Code
Black*	B
Blue	S
Green	G
Red	R
Yellow	Y
White†	W

- 1. * Lever color inserts not available in black.
- 2. †Lever not available in white.

Contact Block Mounting Adaptor

Style	Part Number
	HW-CB2C

- 1. Used to mount contact blocks to operator (first pair only).
- 2. IDEC strongly recommends using the safety lever lock to prevent heavy vibration or maintenance personnel from inadvertently unlocking contacts.



Safety Lever Lock

Style	Part Number
	HW9Z-LS

Key Switches 2-Position (Assembled)



2-Position Key Switches

Contact	Mounting	Operator Position		Maintained	Spring Return from Right
		L	R	L 	L 
<i>Operator Only</i>				<i>HW</i> ⊙ <i>K-2A</i>	<i>HW</i> ⊙ <i>K-21B</i>
1NO	1	0	X	HW⊙K-2AF10	HW⊙K-21BF10
1NO-1NC	1	0	X	HW⊙K-2AF11	HW⊙K-21BF11
	2	X	0		
2NO	1	0	X	HW⊙K-2AF20	HW⊙K-21BF20
	2	0	X		
2NO-2NC	1	0	X	HW⊙K-2AF22	HW⊙K-21BF22
	2	X	0		
	3	0	X		
	4	X	0		

- 1. In place of ⊙ enter 1 for plastic bezel or 4 for metal bezel.
- 2. Key is removable in all maintained positions. Other key removable options available.
- 3. Two keys are supplied with all switches.
- 4. All standard operators are keyed alike.
- 5. Other key removable options available. See table below
- 6. For nameplates, see page 596.
- 7. For contact assembly part numbers, see page 600.
- 8. Key is retained in "Spring Return" position.
- 9. All assembled part numbers in catalog include standard fingersafe (HW-F...) contacts.
- 10. Assembled units with spring-up terminals (HW-G...) can be ordered by removing an "F" from the part number (Ex. HW1B-M1F11-R becomes HW1B-M111-R).
- 11. Units with exposed screw terminals (HW-C...) must be ordered as sub-components.
- 12. Additional contact configurations available (up to 6 total contacts).
- 13. For Truth Tables see page 600.

⊙ Bezel Type

Type	Code
Plastic	1
Metal	4

Key Removable Option Codes

Code	Description
A	Key not retained in any position (removable in all positions)
B	Key retained in right position only
C	Key retained in left position only

Part Number Structure

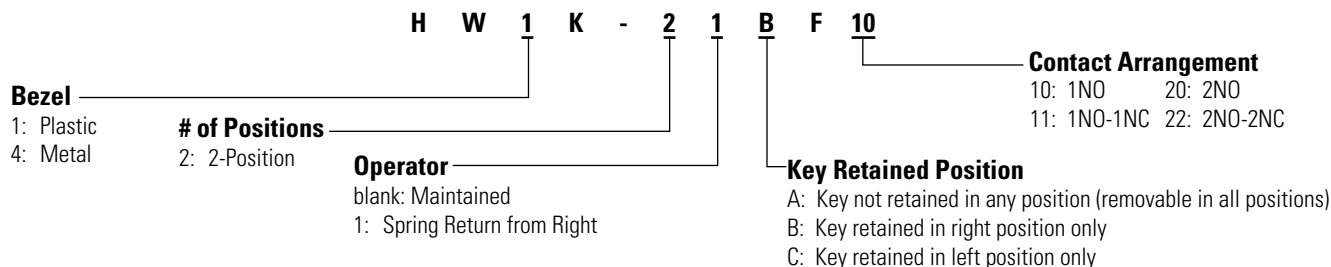

Key Switches 2-Position (Replacement Parts)

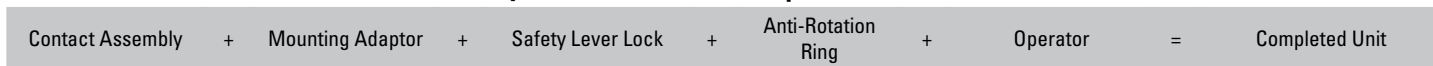

Contact Blocks

Style	Contacts	1NO	1NC
	Standard Fingersafe (IP20)	HW-F10	HW-F01
		HW-F10R (early make)	HW-F01R (late break)
	Spring-Up Terminal	HW-G10	HW-G01
		HW-G10R (early make)	HW-G01R (late break)
	Exposed Screw Terminal	HW-C10	HW-C01
		HW-C10R (early make)	HW-C01R (late break)
	Dummy Block	TW-DB	

Safety Lever Lock

Style	Part Number
	HW9Z-LS

Anti-Rotation Ring

Style	Part Number
	HW9Z-RL

Use with notched panel cutout to prevent unit rotation.

Operators

Style	Description	Plastic Bezel	Metal Bezel
	Maintained	HW1K-2A	HW4K-2A
	Maintained, key removed left only	HW1K-2B	HW4K-2B
	Spring Return from Right	HW1K-21B	HW4K-21B
	Maintained, key removed right only	HW1K-2C	HW4K-2C

1. Operator includes two keys.
2. All standard operators are keyed alike.

Contact Block Mounting Adaptor

Style	Part Number
	HW-CB2C

1. Used to mount contact blocks to operator (first pair only).
2. IDEC strongly recommends using the safety lever lock to prevent heavy vibration or maintenance personnel from inadvertently unlocking contacts.

Key Switches 3-Position (Assembled)



3-Position Key Switches

Contact	Mounting	Operator Position			Maintained	Spring Return from Right	Spring Return from Left	Spring Return Two Way
		L	C	R				
Operator Only								
					<i>HW⊙K-3A*</i>	<i>HW⊙K-31B</i>	<i>HW⊙K-32C</i>	<i>HW⊙K-33D</i>
1NO-1NC	1	0	X	X	HW⊙K-3AF11	HW⊙K-31BF11	HW⊙K-32CF11	HW⊙K-33DF11
	2	0	0	X				
2NO	1	X	0	0	HW⊙K-3AF20	HW⊙K-31BF20	HW⊙K-32CF20	HW⊙K-33DF20
	2	0	0	X				
2NC	1	0	X	X	HW⊙K-3AF02	HW⊙K-31BF02	HW⊙K-32CF02	HW⊙K-33DF02
	2	X	X	0				
2NO-1NC	1	X	0	0	HW⊙K-3JAF21N1	-	-	-
	2	0	0	X				
	3	0	X	0				
2NO-2NC	1	X	0	0	HW⊙K-3AF22	HW⊙K-31BF22	HW⊙K-32CF22	HW⊙K-33DF22
	2	0	0	X				
	3	0	X	X				
	4	X	X	0				
2NO-2NC	1	0	0	X	HW⊙K-3SAF22N9	-	-	-
	2	X	0	0				
	3	X	X	0				
	4	0	0	X				
4NO	1	X	0	0	HW⊙K-3AF40	HW⊙K-31BF40	HW⊙K-32CF40	HW⊙K-33DF40
	2	0	0	X				
	3	X	0	0				
	4	0	0	X				
4NO	1	X	0	0	HW⊙K-3SAF40N2	-	-	-
	2	0	X	X				
	3	X	0	0				
	4	0	0	X				
4NC	1	0	X	X	HW⊙K-3AF04	HW⊙K-31BF04	HW⊙K-32CF04	HW⊙K-33DF04
	2	X	X	0				
	3	0	X	X				
	4	X	X	0				

Ⓢ Bezel Type

Type	Code
Plastic	1
Metal	4



- In place of ⊙ enter 1 for plastic bezel or 4 for metal bezel.
- Key is removable in all maintained positions. Other key removable options available.
- Two keys are supplied with all switches.
- All standard operators are keyed alike.
- Other key removable options available. See table to the right.
- * Operator is available with three different cams.
HW⊙K-3A: Maintained (standard cam)
HW⊙K-3SA: Maintained (Cam S)
HW⊙K-3JA: Maintained (Cam J)
- For nameplates, see page 596.
- For contact assembly part numbers, see page 600.
- All assembled part numbers in catalog include standard fingersafe (HW-F...) contacts.
- Assembled units with spring-up terminals (HW-G...) can be ordered by removing an "F" from the part number (Ex. HW1B-M1F11-R becomes HW1B-M111-R).
- Units with exposed screw terminals (HW-C...) must be ordered as sub-components.
- Additional contact configurations available (up to 6 total contacts).
- For Truth Tables see page 608.

Key Removable Option Codes

Code	Description
A	Key not retained in any position (removable in all positions)
B	Key retained in right position only
C	Key retained in left position only
D	Key retained in left and right (3 position only)
E	Key retained in center only (3 position only)
G	Key retained right and center (3 position only)
H	Key retained left and center (3 position only)

Part Number Structure

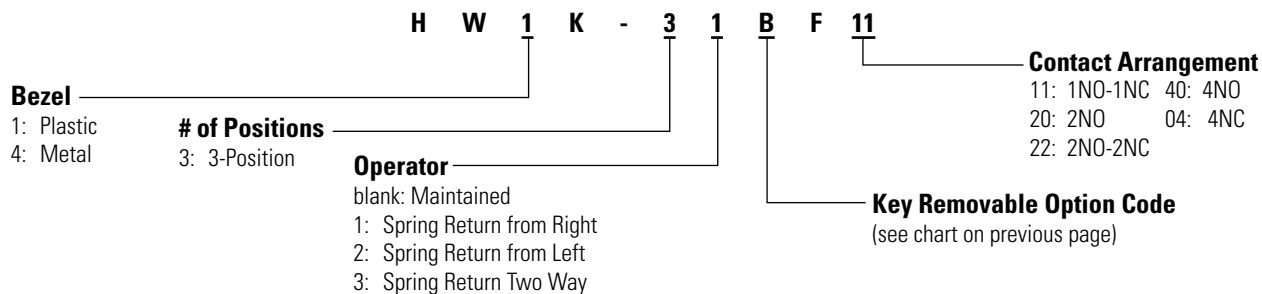

Key Switches 3-Position (Replacement Parts)

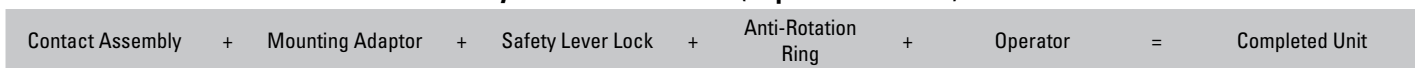

Contact Blocks

Style	Contacts	1NO	1NC
	Standard Fingersafe (IP20)	HW-F10	HW-F01
		HW-F10R (early make)	HW-F01R (late break)
	Spring-Up Terminal	HW-G10	HW-G01
		HW-G10R (early make)	HW-G01R (late break)
	Exposed Screw Terminal	HW-C10	HW-C01
		HW-C10R (early make)	HW-C01R (late break)
	Dummy Block	TW-DB	

Safety Lever Lock

Style	Part Number
	HW9Z-LS

Anti-Rotation Ring

Style	Part Number
	HW9Z-RL

Use with notched panel cutout to prevent unit rotation.

Operators

Style	Description	Plastic Bezel	Metal Bezel
	Maintained (standard cam)	HW1K-3A	HW4K-3A
	Maintained (S cam)	HW1K-3SA	HW4K-3SA
	Maintained (J cam)	HW1K-3JA	HW4K-3JA
	Spring Return from Right (standard cam)	HW1K-31B	HW4K-31B
	Spring Return from Left (standard cam)	HW1K-32C	HW4K-32C
	2-Way Spring Return (standard cam)	HW1K-33D	HW4K-33D

1. Operator includes two keys.
2. All standard operators are keyed alike.
3. Other key removable options available. See table on previous page.
4. Key not removable from spring-returned position

Contact Block Mounting Adaptor

Style	Part Number
	HW-CB2C

1. Used to mount contact blocks to operator (first pair only).
2. IDEC strongly recommends using the safety lever lock to prevent heavy vibration or maintenance personnel from inadvertently unlocking contacts.

Illuminated Selector Switches 2-Position (Assembled)



2-Position Illuminated Selector Switches

Contact	Mounting	Style		Part Number			
		Operator Position		Type	Maintained	Spring Return from Right	
		L	R		L	R	
<i>Operator Only</i>					HWⓄF-2②	HWⓄF-2①	
1NO-1NC	1 2	0 X	X 0	Full Voltage	HWⓄF-2F11Q④-②-③	HWⓄF-21F11Q④-②-③	
				Transformer	120V	HWⓄF-2F11H2④-②	HWⓄF-21F11H2④-②
					240V	HWⓄF-2F11M4④-②	HWⓄF-21F11M4④-②
2NO	1 2	0 0	X X	Full Voltage	HWⓄF-2F20Q④-②-③	HWⓄF-21F20Q④-②-③	
				Transformer	120V	HWⓄF-2F20H2④-②	HWⓄF-21F20H2④-②
					240V	HWⓄF-2F20M4④-②	HWⓄF-21F20M4④-②
2NO-2NC	1 2 3 4	0 X 0 X	X 0 X 0	Full Voltage	HWⓄF-2F22Q④-②-③	HWⓄF-21F22Q④-②-③	
				Transformer	120V	HWⓄF-2F22H2④-②	HWⓄF-21F22H2④-②
					240V	HWⓄF-2F22M4④-②	HWⓄF-21F22M4④-②
				480V	HWⓄF-2F22T8④-②	HWⓄF-21F22T8④-②	



- In place of ② specify Lens/LED color code.
- In place of ③ specify Full Voltage code.
- In place of ④ specify Lamp code.
- In place of ⑤ enter 1 for plastic bezel or 4 for metal bezel.
- For nameplates, see page 596.
- For contact assembly part numbers, see page 600.
- Light is independent of switch position.
- All assembled part numbers in catalog include standard fingersafe (HW-F...) contacts.
- Assembled units with spring-up terminals (HW-G...) can be ordered by removing an "F" from the part number (Ex. HW1B-M1F11-R becomes HW1B-M111-R).
- Units with exposed screw terminals (HW-C...) must be ordered as sub-components.
- Yellow selector switch comes with white LED.**
- Additional contact configurations available (up to 6 total contacts).
- For Truth Tables see page 608.

② Lens/LED Color Code

Color	Code
Amber	A
Green	G
Red	R
Blue	S
White	W
Yellow	Y

③ Full Voltage Code

Full Voltage Models	
Voltage	Code
6VAC/DC	6V
12VAC/DC	12V
24VAC/DC	24V
120V AC (LED only)	120V
240V AC (LED only)	240V

④ Lamp Code

Lamp	Code
Incandescent	Blank
LED	D

⑤ Bezel Code

Type	Code
Plastic	1
Metal	4

Part Number Structure

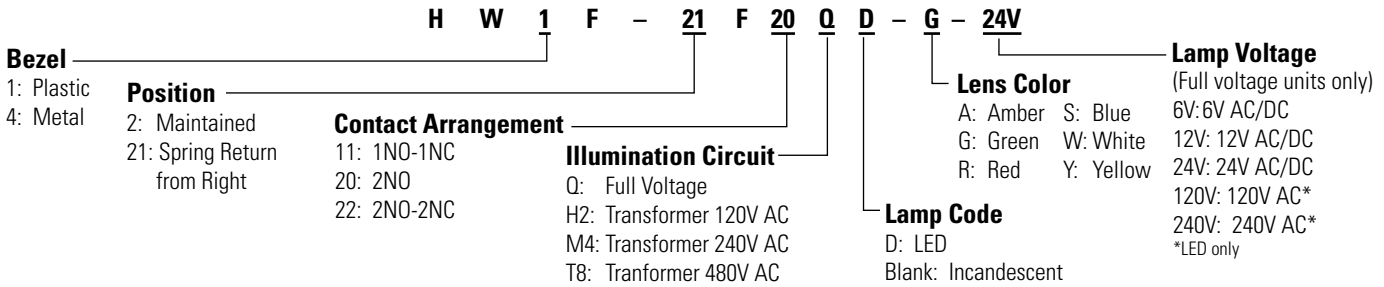

Illuminated Selector Switches 2-Position (Replacement Parts)



*Transformer not needed with full voltage models.

Lamp Circuit Components

Style	Description	Terminals	Part Number
	For use with HW-CBL on all illuminated pushbutton units. One required for each deck (pair) of contacts.		HW-LH3
	For use with odd number of contacts.	Fingersafe	HW-DA1FB
		Exposed	HW-DA1B
		Spring Up	HW-GA1
	For use with even number of contacts.	Fingersafe	TW-DA1FB
		Exposed	TW-DA1B
	120VAC	Fingersafe	TW-F126B
	240VAC		TW-F246B
	480VAC		TW-F486B
	120V	Spring Up	HW-T126
	240V		HW-T246
	480V		HW-L486
	120V	Exposed	TW-T126B
	240V		TW-T246B
	480V		TW-T486B
DC-DC Converter	110VDC		HW-L16D

- 1. HW-GA1 "Dummy Block with full voltage adaptor" does not require the use of HW-LH3.
- 2. DC-DC convertor features spring-up terminals.
- 3. DC-DC convertor applicable voltage range 90-140V DC.

Operators

Style	Description	Plastic Bezel	Metal Bezel
	Maintained	HW1F-2	HW4F-2
	Spring return from right	HW1F-21	HW4F-21

Illuminated knobs must be ordered separately.

Contact Blocks

Style	Contacts	1NO	1NC
	Standard Fingersafe (IP20)	HW-F10 HW-F10R (early make)	HW-F01 HW-F01R (late break)
	Spring-Up Terminal	HW-G10 HW-G10R (early make)	HW-G01 HW-G01R (late break)
	Exposed Screw Terminal	HW-C10 HW-C10R (early make)	HW-C01 HW-C01R (late break)

Contact Block Mounting Adaptor

Style	Part Number
	HW-CBL

- 1. Used to mount contact blocks to operator (first pair only).
- 2. IDEC strongly recommends using the safety lever lock to prevent heavy vibration or maintenance personnel from inadvertently unlocking contacts.

Safety Lever Lock

Style	Part Number
	HW9Z-LS

Illuminated Knob

Appearance	Part Number
	HW9Z-FDY-⊙

In place of ⊙, specify the Color Code.

⊙ Lens/LED Color Code

Color	Code	Color	Code
Amber	A	Blue	S
Green	G	White	W
Red	R	Yellow	Y

Anti-Rotation Ring

Style	Part Number
	HW9Z-RL

Use with notched panel cutout to prevent unit rotation.

Lamps

Style	Voltage	Part Number
	6V AC/DC	LSTD-6⊙
	12V AC/DC	LSTD-1⊙
	24V AC/DC	LSTD-2⊙
	120V AC	LSTD-H2⊙
	240V AC	LSTD-M4⊙
	6V AC/DC	IS-6
	12V AC/DC	IS-12
	24V AC/DC	IS-24

- 1. In place of ⊙, specify the LED Color Code.
- 2. The LED contains a current-limiting resistor and reverse polarity protection diodes.
- 3. Use white LED for yellow lens. Yellow LED not available.

Illuminated Selector Switches 3-Position (Assembled)



3-Position Illuminated Selector Switches

Contact	Mounting	Style			Type	Part Number				
		Operator Position				Maintained	Spring Return from Right	Spring Return from Left	Spring Return Two-Way	
		L	C	R						
Operator Only						HWⓄF-3Ⓞ	HWⓄF-31Ⓞ	HWⓄF-32Ⓞ	HWⓄF-33Ⓞ	
1NO-1NC	1 2	0 0	X 0	X X	Full Voltage	HWⓄF-3F11QⓄ-②-③	HWⓄF-31F11QⓄ-②-③	HWⓄF-32F11QⓄ-②-③	HWⓄF-33F11QⓄ-②-③	
					Transformer	120V	HWⓄF-3F11H2Ⓞ-②	HWⓄF-31F11H2Ⓞ-②	HWⓄF-32F11H2Ⓞ-②	HWⓄF-33F11H2Ⓞ-②
						240V	HWⓄF-3F11M4Ⓞ-②	HWⓄF-31F11M4Ⓞ-②	HWⓄF-32F11M4Ⓞ-②	HWⓄF-33F11M4Ⓞ-②
2NO	1 2	0 0	X 0	0 X	Full Voltage	HWⓄF-3F20QⓄ-②-③	HWⓄF-31F20QⓄ-②-③	HWⓄF-32F20QⓄ-②-③	HWⓄF-33F20QⓄ-②-③	
					Transformer	120V	HWⓄF-3F20H2Ⓞ-②	HWⓄF-31F20H2Ⓞ-②	HWⓄF-32F20H2Ⓞ-②	HWⓄF-33F20H2Ⓞ-②
						240V	HWⓄF-3F20M4Ⓞ-②	HWⓄF-31F20M4Ⓞ-②	HWⓄF-32F20M4Ⓞ-②	HWⓄF-33F20M4Ⓞ-②
2NC	1 2	0 X	X X	X 0	Full Voltage	HWⓄF-3F02QⓄ-②-③	HWⓄF-31F02QⓄ-②-③	HWⓄF-32F02QⓄ-②-③	HWⓄF-33F02QⓄ-②-③	
					Transformer	120V	HWⓄF-3F02H2Ⓞ-②	HWⓄF-31F02H2Ⓞ-②	HWⓄF-32F02H2Ⓞ-②	HWⓄF-33F02H2Ⓞ-②
						240V	HWⓄF-3F02M4Ⓞ-②	HWⓄF-31F02M4Ⓞ-②	HWⓄF-32F02M4Ⓞ-②	HWⓄF-33F02M4Ⓞ-②
2NO-2NC	1 2 3 4	X 0 0 X	0 0 X X	0 X X 0	Full Voltage	HWⓄF-3F22QⓄ-②-③	HWⓄF-31F22QⓄ-②-③	HWⓄF-32F22QⓄ-②-③	HWⓄF-33F22QⓄ-②-③	
					Transformer	120V	HWⓄF-3F22H2Ⓞ-②	HWⓄF-31F22H2Ⓞ-②	HWⓄF-32F22H2Ⓞ-②	HWⓄF-33F22H2Ⓞ-②
						240V	HWⓄF-3F22M4Ⓞ-②	HWⓄF-31F22M4Ⓞ-②	HWⓄF-32F22M4Ⓞ-②	HWⓄF-33F22M4Ⓞ-②
4NO	1 2 3 4	X 0 X 0	0 0 0 0	0 X 0 X	Full Voltage	HWⓄF-3F40QⓄ-②-③	HWⓄF-31F40QⓄ-②-③	HWⓄF-32F40QⓄ-②-③	HWⓄF-33F40QⓄ-②-③	
					Transformer	120V	HWⓄF-3F40H2Ⓞ-②	HWⓄF-31F40H2Ⓞ-②	HWⓄF-32F40H2Ⓞ-②	HWⓄF-33F40H2Ⓞ-②
						240V	HWⓄF-3F40M4Ⓞ-②	HWⓄF-31F40M4Ⓞ-②	HWⓄF-32F40M4Ⓞ-②	HWⓄF-33F40M4Ⓞ-②
4NC	1 2 3 4	0 X 0 X	X X X X	X 0 X 0	Full Voltage	HWⓄF-3F04QⓄ-②-③	HWⓄF-31F04QⓄ-②-③	HWⓄF-32F04QⓄ-②-③	HWⓄF-33F04QⓄ-②-③	
					Transformer	120V	HWⓄF-3F04H2Ⓞ-②	HWⓄF-31F04H2Ⓞ-②	HWⓄF-32F04H2Ⓞ-②	HWⓄF-33F04H2Ⓞ-②
						240V	HWⓄF-3F04M4Ⓞ-②	HWⓄF-31F04M4Ⓞ-②	HWⓄF-32F04M4Ⓞ-②	HWⓄF-33F04M4Ⓞ-②
					480V	HWⓄF-3F04T8Ⓞ-②	HWⓄF-31F04T8Ⓞ-②	HWⓄF-32F04T8Ⓞ-②	HWⓄF-33F04T8Ⓞ-②	



- In place of Ⓞ specify Lens/LED color code.
- In place of Ⓞ specify Full Voltage code.
- In place of Ⓞ specify Lamp code.
- In place of Ⓞ enter 1 for plastic bezel or 4 for metal bezel.
- For nameplates, see page 596.
- For contact assembly part numbers, see page 600.
- Light is independent of switch position.
- All assembled part numbers in catalog include standard fingersafe (HW-F...) contacts.
- Assembled units with spring-up terminals (HW-G...) can be ordered by removing an "F" from the part number (Ex. HW1B-M1F11-R becomes HW1B-M111-R).
- Units with exposed screw terminals (HW-C...) must be ordered as sub-components.
- 11. Yellow selector switch comes with white LED.**
- Additional contact configurations available (up to 6 total contacts).
- For Truth Tables see page 608.

② Lens/LED Color

Color	Code
Amber	A
Green	G
Red	R
Blue	S
White	W
Yellow	Y

③ Full Voltage Code

Full Voltage Models	
Voltage	Code
6VAC/DC	6V
12VAC/DC	12V
24VAC/DC	24V
120V AC (LED only)	120V
240V AC (LED only)	240V

④ Lamp Code

Lamp	Code
Incandescent	Blank
LED	D

⑤ Bezel Code

Type	Code
Plastic	1
Metal	4

Part Number Structure

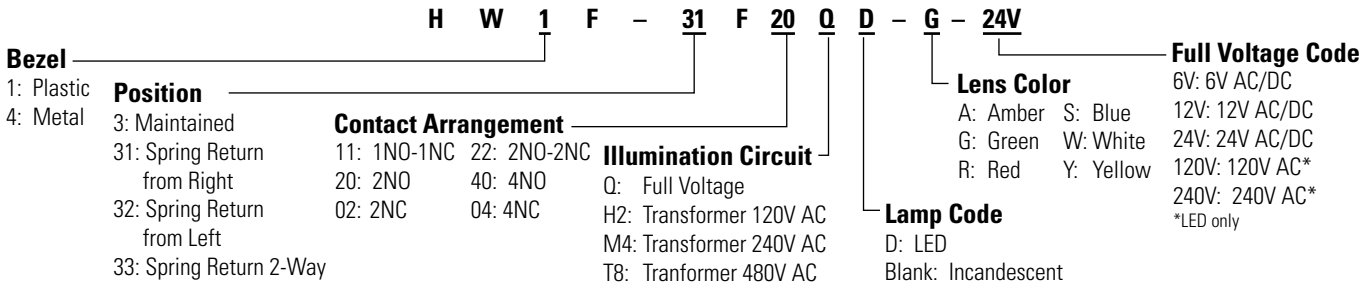

Illuminated Selector Switches 3-Position (Replacement Parts)



*Transformer not needed with full voltage models.

Lamp Circuit Components

Style	Description	Terminals	Part Number
Lead Holder	For use with HW-CBL on all illuminated pushbutton units. One required for each deck (pair) of contacts.		HW-LH3
Dummy Block with Full Voltage Adaptor	For use with odd number of contacts.	Fingersafe	HW-DA1FB
		Exposed	HW-DA1B
		Spring Up	HW-GA1
Full Voltage Adaptor	For use with even number of contacts.	Fingersafe	TW-DA1FB
		Exposed	TW-DA1B
Transformer Unit (6V secondary voltage)	120VAC	Fingersafe	TW-F126B
	240VAC	Fingersafe	TW-F246B
	480VAC	Fingersafe	TW-F486B
	120V 240V 480V	Spring Up	HW-T126 HW-T246 HW-L486
DC-DC Converter	110VDC	Exposed	TW-T126B
			TW-T246B
			TW-T486B
DC-DC Converter	110VDC		HW-L16D

- 1. HW-GA1 "Dummy Block with full voltage adaptor" does not require the use of HW-LH3.
- 2. DC-DC convertor features spring-up terminals.
- 3. DC-DC convertor applicable voltage range 90-140V DC.

Operators

Style	Description	Plastic Bezel	Metal Bezel
	Maintained	HW1F-3	HW4F-3
	Spring return from right	HW1F-31	HW4F-31
	Spring return from left	HW1F-32	HW4F-32
	2-Way spring return	HW1F-33	HW4F-33

Illuminated knobs must be ordered separately.

Contact Blocks

Style	Contacts	1NO	1NC
	Standard Fingersafe (IP20)	HW-F10 HW-F10R (early make)	HW-F01 HW-F01R (late break)
	Spring-Up Terminal	HW-G10 HW-G10R (early make)	HW-G01 HW-G01R (late break)
	Exposed Screw Terminal	HW-C10 HW-C10R (early make)	HW-C01 HW-C01R (late break)

Contact Block Mounting Adaptor

Style	Part Number
	HW-CBL

- 1. Used to mount contact blocks to operator (first pair only).
- 2. IDEC strongly recommends using the safety lever lock to prevent heavy vibration or maintenance personnel from inadvertently unlocking contacts.

Safety Lever Lock

Style	Part Number
	HW9Z-LS

Illuminated Knob

Appearance	Part Number
	HW9Z-FDY-⊙

In place of ⊙, specify the Color Code.

⊙ Lens/LED Color Code

Color	Code	Color	Code
Amber	A	Blue	S
Green	G	White	W
Red	R	Yellow	Y

Anti-Rotation Ring

Style	Part Number
	HW9Z-RL

Use with notched panel cutout to prevent unit rotation.

Lamps

Style	Voltage	Part Number
	6V AC/DC	LSTD-6⊙
	12V AC/DC	LSTD-1⊙
	24V AC/DC	LSTD-2⊙
	120V AC	LSTD-H2⊙
	240V AC	LSTD-M4⊙
	6V AC/DC	IS-6
	12V AC/DC	IS-12
	24V AC/DC	IS-24

- 1. In place of ⊙, specify the LED Color Code.
- 2. The LED contains a current-limiting resistor and reverse polarity protection diodes.
- 3. Use white LED for yellow lens. Yellow LED not available.

Mono Lever Switches 2-Position (Assembled)



2-Position Mono Lever Switches

Style	Part Number	Description
HW1M Standard Lever	HW1M-F1010-20	Maintained up and down
	HW1M-F2020-20	Spring return up and down
	HW1M-F1010-40	Maintained up and down
	HW1M-F2020-40	Spring return up and down
	HW1M-F0101-20	Maintained right and left
	HW1M-F0202-20	Spring return right and left
	HW1M-F0101-40	Maintained right and left
HW1M-L Interlocking Lever	HW1M-F0202-40	Spring return right and left
	HW1M-LF1010-20	Maintained up and down
	HW1M-LF2020-20	Spring return up and down
	HW1M-LF1010-40	Maintained up and down
	HW1M-LF2020-40	Spring return up and down
	HW1M-LF0101-20	Maintained right and left
	HW1M-LF0202-20	Spring return right and left
HW1M-LF0101-40	HW1M-LF0101-40	Maintained right and left
	HW1M-LF0202-40	Spring return right and left

- 1. All assembled part numbers in catalog include standard (HW-F...) contacts.
- 2. Assembled units with spring-up terminals (HW-G...) can be ordered by removing an "F" from the part number (Ex. HW1B-M1F11-R becomes HW1B-M111-R).
- 3. Units with exposed screw terminals (HW-C...) must be ordered as sub-components.
- 4. Additional contact configurations available (up to 6 total contacts).

Circuit Diagrams
2 Position Left/Right

Circuit Number	Contact Mounting		Position		
	No.		Left	Center	Right
20	1	HW-F10	X	0	0
	2	HW-F10	0	0	X
40	1	HW-F10	X	0	0
	2	HW-F10	0	0	X
	3	HW-F10	X	0	0
	4	HW-F10	0	0	X

2 Position Up/Down

Circuit Number	Contact Mounting		Position		
	No.		Down	Center	Up
20	1	HW-F10	X	0	0
	2	HW-F10	0	0	X
40	1	HW-F10	X	0	0
	2	HW-F10	0	0	X
	3	HW-F10	X	0	0
	4	HW-F10	0	0	X

Part Number Structure

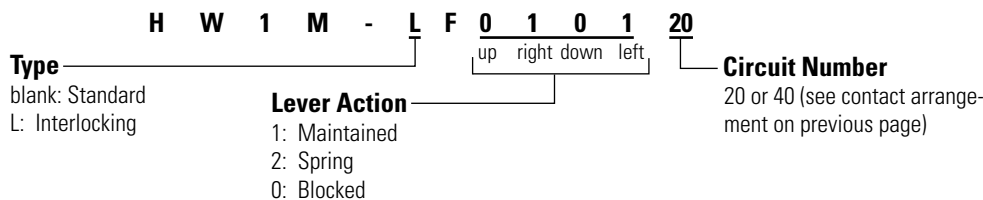

Mono Lever Switches 2-Position (Sub-assembled) Part Numbers

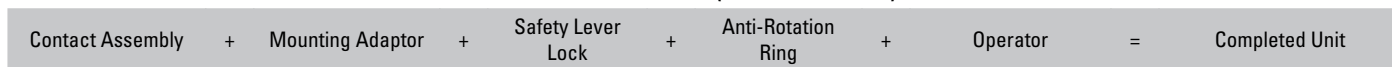

Contact Blocks

Style	Contacts	1NO	1NC
	Standard Fingersafe (IP20)	HW-F10	HW-F01
		HW-F10R (early make)	HW-F01R (late break)
	Spring-Up Terminal	HW-G10	HW-G01
		HW-G10R (early make)	HW-G01R (late break)
	Exposed Screw Terminal	HW-C10	HW-C01
		HW-C10R (early make)	HW-C01R (late break)
	Dummy Block	TW-DB	

Anti-Rotation Ring

Style	Part Number
	HW9Z-RL

Use with notched panel cutout to prevent unit rotation.

Operators

Style	Description	Part Number
	Maintained Up/Down	HW1M-1010
	Spring return Up/Down	HW1M-2020
	Maintained Left/Right	HW1M-0101
	Spring return Left/Right	HW1M-0202
	Maintained Up/Down	HW1M-L1010
	Spring return Up/Down	HW1M-L2020
	Maintained Left/Right	HW1M-L0101
	Spring return Left/Right	HW1M-L0202

Contact Block Mounting Adaptor

Style	Part Number
	HW-CB2C

1. Used to mount contact blocks to operator (first pair only).
 2. IDEC strongly recommends using the safety lever lock (included) to prevent heavy vibration or maintenance personnel from inadvertently unlocking contacts.

Safety Lever Lock

Style	Part Number
	HW9Z-LS

Replacement Parts

Item	Part Number
Black Cap 	HW9Z-CPM
Boot 	HW9Z-BLM (fits standard operator only)

Mono Lever Switches 3- & 4-Position (Assembled)



3-Position

Style	Part Number	Description
HW1M Standard Lever	HW1M-F0121-30	Maintained right and left, spring return down
	HW1M-F0222-30	Spring return right, down, left
HW1M-L Interlocking Lever	HW1M-LF0121-30	Maintained right and left, spring return down
	HW1M-LF0222-30	Spring return right, down, left

Circuit Diagram

Circuit Number	Contact Mounting		Position				
	No.		Down	Left	Center	Up	Right
30	1	HW-F01	0	0	0	0	X
	2	HW-F01	X	0	0	0	0
	3	HW-F10	0	X	0	0	0

4-Position

Style	Part Number	Description
HW1M Standard Lever	HW1M-F1111-22N9	Maintained all positions
	HW1M-F1212-22N9	Maintained up and down, spring left and right
	HW1M-2121-22N9	Spring up and down, maintained left and right
	HW1M-2222-22N9	Spring return all positions
HW1M-L Interlocking Lever	HW1M-LF1111-22N9	Maintained all positions
	HW1M-LF1212-22N9	Maintained up and down, spring left and right
	HW1M-LF2121-22N9	Spring up and down, maintained left and right
	HW1M-LF2222-22N9	Spring return all positions

Circuit Diagram

Circuit Number	Contact Mounting		Position				
	No.		Down	Left	Center	Up	Right
22N9	1	HW-F01	0	0	0	0	X
	2	HW-F01	X	0	0	0	0
	3	HW-F10	0	X	0	0	0
	4	HW-F10	0	0	0	X	0

- 1. All assembled part numbers in catalog include standard (HW-F...) contacts.
- 2. Assembled units with spring-up terminals (HW-G...) can be ordered by removing an "F" from the part number (Ex. HW1B-M1F11-R becomes HW1B-M111-R).
- 3. Units with exposed screw terminals (HW-C...) must be ordered as sub-components.
- 4. Additional contact configurations available (up to 6 total contacts).

Part Number Structure

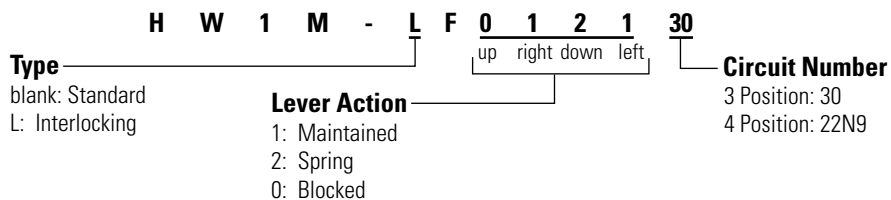

Mono Lever Switches 3 & 4-Position (Sub-assembled) Part Numbers

Contact Assembly	+	Mounting Adaptor	+	Safety Lever Lock	+	Anti-Rotation Ring	+	Operator	=	Completed Unit
------------------	---	------------------	---	-------------------	---	--------------------	---	----------	---	----------------



Contact Blocks

Style	Contacts	1NO	1NC
	Standard Fingersafe (IP20)	HW-F10	HW-F01
		HW-F10R (early make)	HW-F01R (late break)
	Spring-Up Terminal	HW-G10	HW-G01
		HW-G10R (early make)	HW-G01R (late break)
	Exposed Screw Terminal	HW-C10	HW-C01
		HW-C10R (early make)	HW-C01R (late break)
	Dummy Block	TW-DB	

Anti-Rotation Ring

Style	Part Number
	HW9Z-RL



Use with notched panel cutout to prevent unit rotation.

Operators

Style	Description	Part Number
	Standard	
	Combination, 3 position	HW1M-0121
	Spring return, 3 position	HW1M-0222
	Maintained, 4 position	HW1M-1111
	Combination, 4 position	HW1M-1212
	Combination, 4 position	HW1M-2121
	Interlocking	
	Combination, 3 position	HW1M-L0121
	Spring return, 3 position	HW1M-L0222
	Maintained, 4 position	HW1M-L1111
	Combination, 4 position	HW1M-L1212
	Combination, 4 position	HW1M-L2121
	Spring return, 4 position	HW1M-L2222

Contact Block Mounting Adaptor

Style	Part Number
	HW-CB2C



- Used to mount contact blocks to operator (first pair only).
- IEDEC strongly recommends using the safety lever lock (included) to prevent heavy vibration or maintenance personnel from inadvertently unlocking contacts.

Safety Lever Lock

Style	Part Number
	HW9Z-LS

Replacement Parts

Item	Part Number
Black Cap	
	HW9Z-CPM
Boot	
	HW9Z-BLM (fits standard operator only)

Pushbutton Selectors (Assembled)



2-Position Pushbutton Selectors

Cam	Contacts	Mounting	Operator Position				Part Number	
			Left		Right			
			Normal	Push	Normal	Push		
A	<i>Operator Only</i>						<i>HW1R-2A-①</i>	
	1NO-1NC	1	HW-F10	0	X	0	X	HW1R-2AF11-①
		2	HW-F01	X	0	0	0	
	2NO	1	HW-F10	0	X	0	X	HW1R-2AF20-①
2		HW-F10	0	X	X	X		
2NO-2NC	1	HW-F10	0	X	0	X	HW1R-2AF22-①	
	2	HW-F01	X	0	0	0		
	3	HW-F10	0	X	0	X		
	4	HW-F01	X	0	0	0		
D	<i>Operator Only</i>						<i>HW1R-2D-①</i>	
	2NO	1	HW-F10	0	X	0	0	HW1R-2DF20-①
		2	HW-F10	0	0	0	X	
	2NO-2NC	1	HW-F10	0	X	0	0	HW1R-2DF22N1-①
2		HW-F10	0	0	0	X		
3		HW-F01	X	0	X	X		
4		HW-F01	X	X	X	0		
E	<i>Operator Only</i>						<i>HW1R-2E-①</i>	
	2NO-2NC	1	HW-F10	0	X	0	0	HW1R-2EF22N1-①
		2	HW-F10	0	0	0	X	
		3	HW-F01	0	0	X	X	
4		HW-F01	X	X	0	0		
F	<i>Operator Only</i>						<i>HW1R-2F-①</i>	
	2NO-2NC	1	HW-F10	0	0	0	X	HW1R-2FF22N1-①
		2	HW-F10	0	X	0	0	
		3	HW-F01	0	0	X	0	
4		HW-F01	X	0	0	0		
N	<i>Operator Only</i>						<i>HW1R-2N-①</i>	
	2NO-2NC	1	HW-F01	0	0	X	0	HW1R-2NF22N2-①
		2	HW-F10	0	X	0	X	
		3	HW-F01	0	0	X	0	
4		HW-F10	0	X	0	X		
T	<i>Operator Only</i>						<i>HW1R-2T-①</i>	
	2NO-2NC	1	HW-F10	0	X	X		HW1R-2TF22N1-①
		2	HW-F10	0	X	X		
		3	HW-F01	X	0	0	Blocked	
4		HW-F01	X	0	0			

① Button Color Code

Color	Code	Color	Code
Black	B	White	W
Green	G	Yellow	Y
Red	R	Gray	N
Blue	S		



- All assembled part numbers in catalog include standard (HW-F...) contacts.
- Assembled units with spring-up terminals (HW-G...) can be ordered by removing an "F" from the part number (Ex. HW1B-M1F11-R becomes HW1B-M111-R).
- Units with exposed screw terminals (HW-C...) must be ordered as sub-components.
- Operator only models come with operator and button.
- Additional contact configurations available (up to 6 total contacts).

Part Number Structure

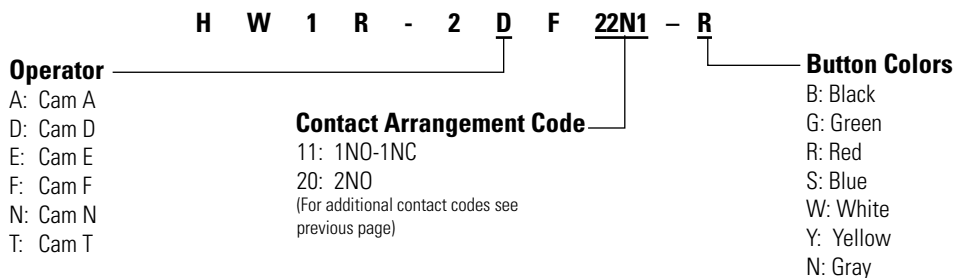

Pushbutton Selectors (Sub-assembled)

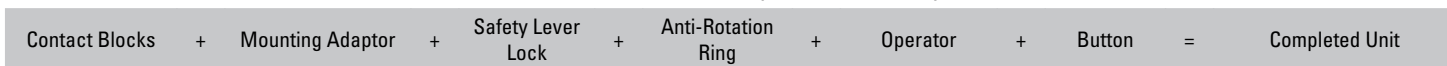

Contact Blocks

Style	Contacts	1NO	1NC
	Standard Fingersafe (IP20)	HW-F10	HW-F01
		HW-F10R (early make)	HW-F01R (late break)
	Spring-Up Terminal	HW-G10	HW-G01
		HW-G10R (early make)	HW-G01R (late break)
	Exposed Screw Terminal	HW-C10	HW-C01
		HW-C10R (early make)	HW-C01R (late break)
	Dummy Block	TW-DB	

Contact Block Mounting Adaptor

(safety lever lock included)

Style	Part Number
	HW-CB2C

- 1. Used to mount contact blocks to operator (first pair only).
- 2. IDEC strongly recommends using the safety lever lock (included) to prevent heavy vibration or maintenance personnel from inadvertently unlocking contacts.

Safety Lever Lock

Style	Part Number
	HW9Z-LS

Anti-Rotation Ring

Style	Part Number
	HW9Z-RL

Use with notched panel cutout to prevent unit rotation.

Operators

Style	Description	Part Number
	Cam A	HW1R-2A
	Cam D	HW1R-2D
	Cam E	HW1R-2E
	Cam F	HW1R-2F
	Cam N	HW1R-2N
	Cam T	HW1R-2T

Buttons

Style	Part Number
Round Flush	HW1A-B1-Ⓢ

In place of Ⓢ, specify the Button Color Code from table below.

Ⓢ Button Color Code

Color	Code	Color	Code
Black	B	White	W
Green	G	Yellow	Y
Red	R	Gray	N
Blue	S		

Dual Pushbutton Switches

Key features:

- Two pushbuttons and a pilot light are integrated into one space-saving ø22 mm control unit.
- Momentary and interlock types are available for pushbuttons. Interlock type prevents both buttons from being pressed at the same time.
- Pilot lights are available in full voltage and transformer with LED or incandescent lamps.
- IP40 protection, IP65 when using silicon cover.
- UL Listed, CSA approved, and EN compliant



Applications:

- Ideal for use as power switches and start/stop switches (available with I/ON and O/OFF markings on the buttons and a pilot light in the center).
- Interlock type prevents two pushbuttons from being pressed at the same time.



Dual Pushbutton Switches (Assembled) Part Numbers

Without Center Pilot Light

Operation Type	Button Style	Image	Contact Arrangement		Part Number	Ⓞ Button Color Code	Ⓞ Legend Code		
			Top Button	Bottom Button					
Momentary	Flush (top) Flush (bottom)		1NO	1NC	HW7D-B11F1001-ⓄⓄ	GR: Green (top) Red (bottom)	Blank: Without legend		
			1NO	1NO	HW7D-B11F1010-ⓄⓄ				
			1NO-1NC	1NO-1NC	HW7D-B11F1111-ⓄⓄ				
			2NO	2NC	HW7D-B11F2002-ⓄⓄ				
			2NO	2NO	HW7D-B11F2020-ⓄⓄ				
Momentary	Flush (top) Extended (bottom)		1NO	1NC	HW7D-B12F1001-ⓄⓄ				
			1NO	1NO	HW7D-B12F1010-ⓄⓄ				
			1NO-1NC	1NO-1NC	HW7D-B12F1111-ⓄⓄ				
			2NO	2NC	HW7D-B12F2002-ⓄⓄ				
			2NO	2NO	HW7D-B12F2020-ⓄⓄ				
Interlock*	Flush (top) Flush (bottom)		1NO	1NC	HW7D-B21F1001-ⓄⓄ			WB: White (top) Black (bottom)	1: I/ON (top) O/OFF (bottom)
			1NO	1NO	HW7D-B21F1010-ⓄⓄ				
			1NO-1NC	1NO-1NC	HW7D-B21F1111-ⓄⓄ				
			2NO	2NC	HW7D-B21F2002-ⓄⓄ				
			2NO	2NO	HW7D-B21F2020-ⓄⓄ				
	Interlock*	Flush (top) Extended (bottom)		1NO	1NC	HW7D-B22F1001-ⓄⓄ			
				1NO	1NO	HW7D-B22F1010-ⓄⓄ			
				1NO-1NC	1NO-1NC	HW7D-B22F1111-ⓄⓄ			
				2NO	2NC	HW7D-B22F2002-ⓄⓄ			
				2NO	2NO	HW7D-B22F2020-ⓄⓄ			

1. *Interlock type prevents both top and bottom buttons from being pressed simultaneously.
 2. Clear silicon rubber cover part number HW9Z-D7D.
 3. Additional contact configurations available (up to 6 total contacts).

With Center Pilot Light

Operation Type	Button Style		Top Button	Bottom Button	Part Number
Momentary	Flush (Top) Flush (Bottom)	Flush (top) Flush (bottom)	1NO	1NC	HW7D-L11F1001②③-④⑤
			1NO	1NO	HW7D-L11F1010②③-④⑤
			1NO-1NC	1NO-1NC	HW7D-L11F1111②③-④⑤
			2NO	2NC	HW7D-L11F2002②③-④⑤
			2NO	2NO	HW7D-L11F2020②③-④⑤
	Flush (Top) Extended (Bottom)		1NO	1NC	HW7D-L12F1001②③-④⑤
			1NO	1NO	HW7D-L12F1010②③-④⑤
			1NO-1NC	1NO-1NC	HW7D-L12F1111②③-④⑤
			2NO	2NC	HW7D-L12F2002②③-④⑤
			2NO	2NO	HW7D-L12F2020②③-④⑤
Interlock*	Flush (Top) Flush (Bottom)	Flush (top) Extended (bottom)	1NO	1NC	HW7D-L21F1001②③-④⑤
			1NO	1NO	HW7D-L21F1010②③-④⑤
			1NO-1NC	1NO-1NC	HW7D-L21F1111②③-④⑤
			2NO	2NC	HW7D-L21F2002②③-④⑤
			2NO	2NO	HW7D-L21F2020②③-④⑤
	Flush (Top) Extended (Bottom)		1NO	1NC	HW7D-L22F1001②③-④⑤
			1NO	1NO	HW7D-L22F1010②③-④⑤
			1NO-1NC	1NO-1NC	HW7D-L22F1111②③-④⑤
			2NO	2NC	HW7D-L22F2002②③-④⑤
			2NO	2NO	HW7D-L22F2020②③-④⑤

- 1. *Interlock type prevents both top and bottom buttons from being pressed simultaneously.
- 2. Clear silicon rubber cover part number HW9Z-D7D.
- 3. All assembled part numbers in catalog include standard (HW-F...) contacts.
- 4. Assembled units with spring-up terminals (HW-G...) can be ordered by removing an "F" from the part number (Ex. HW1B-M1F11-R becomes HW1B-M111-R).
- 5. Units with exposed screw terminals (HW-C...) must be ordered as sub-components.

② Pilot Light Illumination & Voltage Code

Full Voltage	
Voltage	Code
6V AC/DC, LED	Q2
12V AC/DC, LED	Q3
24V AC/DC, LED	Q4
120V AC, LED	Q8
6V AC/DC, Incandescent	Q5*
12V AC/DC, Incandescent	Q6*
24V AC/DC, Incandescent	Q7*

Step-Down Transformer (6V Secondary Lamp Voltage)	
Voltage	Code
120V AC, LED	H22
240V AC, LED	M42
480V AC, LED	T82
120V AC, Incandescent	H25*
240V AC, Incandescent	M45*
480V AC, Incandescent	T85*

 *Only available for White Lens Pilot Lamp.

③ Pilot Lamp Color Code

Color	Code
Amber	A*
Green	G*
Red	R*
Blue	S*
White	W

 *Only available in LED illumination.

④ Pushbutton Color Code

Color	Code	
Top	Green	GR
Bottom	Red	
Top	White	WB
Bottom	Black	

⑤ Engraving Codes

Engraving		Code
No Engraving		Blank
I/ON	Top	1
O/OFF	Bottom	

Switches & Pilot Devices

Signaling Lights

Relays & Sockets

Timers

Contactors

Terminal Blocks

Circuit Breakers

Part Number Structure

H W 7 D - L 21 F 20 20 H22 R - GR 1

Pilot Light

B: Without Center Pilot Light
L: With Center Pilot Light

Button Arrangement

11: Momentary (Flush/Flush)
12: Momentary (Flush/Extended)
21: Interlock (Flush/Flush)
22: Interlock (Flush/Extended)

Contact Arrangement

Top Button

01: 1NC 02: 2NC
10: 1NO 20: 2NO

Bottom Button

01: 1NC 02: 2NC
10: 1NO 20: 2NO

Voltage Code

blank: without center pilot light

Full Voltage*

Q2: 6V LED

Transformer*

H22: 120V AC LED

*For additional voltage codes, please see previous page

Pilot Lamp Color

A: Amber* Y: Yellow*

G: Green* blank: without center

R: Red* pilot light

S: Blue*

W: White

*Only available in LED illumination.

Engraving Code

blank: No Engraving

1: Top: I/ON

Bottom: O/OFF

Pushbutton Color

GR: Top: Green

Bottom: Red

WB: Top: White

Bottom: Black

Dual Pushbutton Switches (Sub-assembled) Part Numbers

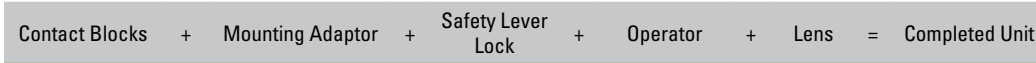

Lamp Circuit Components with Fingersafe Terminals

Style	Description	Part Number
Lead Holder	For use with HW-CBL on all illuminated pushbutton units. One required for each deck (pair) of contacts.	HW-LH3
Dummy Block with Full Voltage Adaptor	For use with odd number of contacts.	HW-DA1FB
Full Voltage Adaptor	For use with even number of contacts.	TW-DA1FB
Transformer Unit (6V secondary voltage)	120VAC 240VAC 480VAC	TW-F126B TW-F246B TW-F486B

Exposed and spring up terminals also available.

Operators

Style	Button	Part Number
Momentary	Flush (top)	HW7D-*11④-⑤
	Flush (bottom)	
	Flush (top)	HW7D-*12④-⑤
	Extended (bottom)	
Interlock	Flush (top)	HW7D-*21④-⑤
	Flush (bottom)	
	Flush (top)	HW7D-*22④-⑤
	Extended (bottom)	

Instead of * insert:
B: Non-illuminated
L: Illuminated

④ Pushbutton Color Code

Color	Code	Color	Code
Top Green	GR	Top White	WB
Bottom Red		Bottom Black	

Contact Blocks

Style	Contacts	1NO	1NC
Standard Fingersafe (IP20)		HW-F10 HW-F10R (early make)	HW-F01 HW-F01R (late break)
Dummy Block		TW-DB	

Contact Block Mounting Adaptor

Style	Part Number
Non-illuminated	HW-CB2C
Illuminated (with Pilot Light)	HW-CBL

- Used to mount contact blocks to operator (first pair only).
- IEEC strongly recommends using the safety lever lock (included) to prevent heavy vibration or maintenance personnel from inadvertently unlocking contacts.

Safety Lever Lock

Style	Part Number
	HW9Z-LS

Anti-Rotation Ring

Appearance	Part Number
	HW9Z-RL

Use with notched panel cutout to prevent unit rotation.

⑤ Engraving Codes

Engraving	Code
No Engraving	Blank
I/ON	Top
O/OFF	Bottom

Lamps/Lens

Style	Voltage	Part Number
	6V AC/DC	LSTD-6②
	12V AC/DC	LSTD-1②
	24V AC/DC	LSTD-2②
	120V AC	LSTD-H2②
	240V AC	LSTD-M4②
	6V AC/DC	IS-6
	12V AC/DC	IS-12
	24V AC/DC	IS-24
Non-illuminated		HW9Z-B7B
Illuminated		HW9Z-L7W

- In place of ②, specify the LED Color Code.
- The LED contains a current-limiting resistor and reverse polarity protection diodes.

② LED Color Code

Color	Code	Color	Code
Amber	A*	Blue	S*
Green	G*	White	W
Red	R*		

Only for LED illumination.

Contact Arrangement Chart

Contact Arrangement			Contact Block		Top Button		Bottom Button		
Top Button	Bottom Button	Contact Code	Mounting Position	Type	Normal	Push	Normal	Push	
1NO	1NO	1010	1	NO		X			
			2	NO				X	
1NO	1NC	1001	1	NO		X			
			2	NC			X		
1NC	1NO	0110	1	NC	X				
			2	NO				X	
1NC	1NC	0101	1	NC	X				
			2	NC			X		
1NO	2NO	1020	1	NO		X			
			2	NO				X	
			3	Dummy					
			4	NO				X	
1NO	1NO-1NC	1011	1	NO		X			
			2	NO				X	
			3	Dummy					
			4	NC				X	
1NO	2NC	1002	1	NO		X			
			2	NC			X		
			3	Dummy					
			4	NC				X	
1NC	2NO	0120	1	NC	X				
			2	NO				X	
			3	Dummy					
			4	NO				X	
1NC	1NO-1NC	0111	1	NC	X				
			2	NO				X	
			3	Dummy					
			4	NC				X	
1NC	2NC	0102	1	NC	X				
			2	NC			X		
			3	Dummy					
			4	NC				X	
2NO	1NO	2010	1	NO		X			
			2	NO				X	
			3	NO		X			
			4	Dummy					
2NO	1NC	2001	1	NO		X			
			2	NC			X		
			3	NO		X			
			4	Dummy					
1NO-1NC	1NO	1110	1	NO		X			
			2	NO				X	
			3	NC	X				
			4	Dummy					
1NO-1NC	1NC	1101	1	NO		X			
			2	NO			X		
			3	NC	X				
			4	Dummy					

Contact Block Mounting Position Example

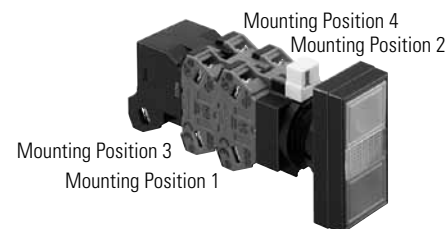

Switches & Pilot Devices

Signaling Lights

Relays & Sockets

Timers

Contactors

Terminal Blocks

Circuit Breakers

1. Transformers can have two or four contact blocks only.
 2. Contact blocks 1 and 3 are actuated by the top button. Contact blocks 2 and 4 are actuated by the bottom button.

Contact Arrangement Chart (con't)

Contact Arrangement			Contact Block		Top Button		Bottom Button	
Top Button	Bottom Button	Contact Code	Mounting Position	Type	Normal	Push	Normal	Push
2NC	1NO	0210	1	NC	X			
			2	NO			X	
			3	NC	X			
			4	Dummy				
2NC	1NC	0201	1	NC	X			
			2	NC			X	
			3	NC	X			
			4	Dummy				
2NO	2NO	2020	1	NO		X		
			2	NO			X	
			3	NO		X		
			4	NO			X	
2NO	1NO-1NC	2011	1	NO		X		
			2	NO			X	
			3	NO		X		
			4	NC			X	
2NO	2NC	2002	1	NO		X		
			2	NC			X	
			3	NO		X		
			4	NC			X	
1NO-1NC	2NO	1120	1	NO		X		
			2	NO			X	
			3	NC	X			
			4	NO			X	
1NO-1NC	1NO-1NC	1111	1	NO		X		
			2	NO			X	
			3	NC	X			
			4	NC			X	
1NO-1NC	2NC	1102	1	NO		X		
			2	NC			X	
			3	NC	X			
			4	NC			X	
2NC	2NO	0220	1	NC	X			
			2	NO			X	
			3	NC	X			
			4	NO			X	
2NC	1NO-1NC	0211	1	NC	X			
			2	NO			X	
			3	NC	X			
			4	NC			X	
2NC	2NC	0202	1	NC	X			
			2	NC			X	
			3	NC	X			
			4	NC			X	

Contact Block Mounting Position Example

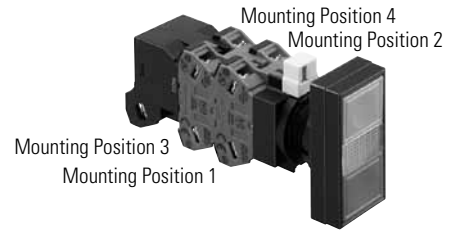

Contactor Reset Button



Reset Buttons (Assembled)

	Plastic Bezel	Metal Bezel
(Blank)	HW1B-M1RS-⊙T	HW4B-M1RS-⊙T
Engraved "R"	HW1B-M1RS-⊙T-ENG-R	HW4B-M1RS-⊙T-ENG-R

- 1. In place of ⊙ specify Button Color Code.
- 2. 130mm (5.1") overall length.
- 3. 16mm flat base for easy alignment

⊙ Button Color Code

Color	Code	Color	Code
Black	B	White	W
Green	G	Yellow	Y
Red	R	Gray	N
Blue	S		

Contactor Reset Button (Sub-assembled)



Rod

Style	Part Number
	HW9Z-RS-TK2141

Button

Style	Part Number
	HW1A-B1-⊙

 In place of ⊙, specify the Button Color Code from table.

Operator

Style	Plastic	Metal
	HW1B-M0	HW4B-M0
		

⊙ Button Color Code

Color	Code	Color	Code
Black	B	White	W
Green	G	Yellow	Y
Red	R	Gray	N
Blue	S		

Nameplates - HW Series

	HWAM-Black Plastic	HWAQ-Black Plastic	HWAS-Black Plastic	HWAV-Yellow Plastic
Nameplate (blank engraving plate included)	HWAM-OB	HWAQ-OB	HWAS-OB	HWAV-0 HWAV5-0†
Nameplate (engraved)	HWAM-⓪	HWAQ-⓪	HWAS-⓪	HWAV-27* HWAV5-27†
Additional Insert (blank)	HWNP-0	HWNP-0	HWNP Dimensions	
Additional Insert (engraved)	HWNP-⓪	HWNP-⓪		

- 1. In place of ⓪, insert either the standard legend code from table below or custom engraving delimited by " ".
- 2. Standard engravings are available at no charge.
- 3. * HWAV-27 comes engraved "Emergency Stop" as shown in drawing.
- 4. † HWAV5-27 and HWAV5-0 for 60mm diameter E-Stops (80mm diameter nameplate).

Standard Legend Codes

Pushbuttons				Pushbuttons/Selector Switches				Selector Switches	
Legend	Code	Legend	Code	Legend	Code	Legend	Code	Legend	Code
AUTO	101	OPEN	116	AUTO-MAN	201	REV-FOR	216	AUTO-MAN-OFF	301
CLOSE	102	OUT	117	CLOSE-OPEN	202	RUN-JOG	217	AUTO-OFF-MAN	302
DOWN	103	RAISE	118	DOWN-UP	203	RUN-SAFE	218	CLOSE-OFF-OPEN	303
EMERG.STOP	104	RESET	119	FAST-SLOW	204	SAFE-RUN	219	DOWN-OFF-SLOW	304
FAST	105	REVERSE	120	FOR-REV	205	SLOW-FAST	220	FAST-OFF-SLOW	305
FORWARD	106	RUN	121	HAND-AUTO	206	START-STOP	221	FOR-OFF-REV	306
HAND	107	SLOW	122	HIGH-LOW	207	STOP-START	222	LEFT-OFF-RIGHT	307
HIGH	108	START	123	JOG-RUN	208	UP-DOWN	223	LOWER-OFF-RAISE	308
IN	109	STOP	125	LEFT-RIGHT	209	OI (Int'l OFF ON)	250	OFF-MAN-AUTO	309
INCH	110	TEST	126	LOWER-RAISE	210			OFF-SLOW-FAST	310
JOG	111	UP	127	MAN-AUTO	211			OFF-1-2	311
LOW	112	I (Int'l On)	150	OFF-ON	212			OPEN-OFF-CLOSE	312
LOWER	113	O (Int'l Off)	151	ON-OFF	213			SLOW-OFF-FAST	313
OFF	114	EMO	152	OPEN-CLOSE	214			SUMMER-OFF-WINTER	314
ON	115			RAISE-LOWER	215			UP-OFF-DOWN	315
								1-OFF-2	316
								HAND-OFF-AUTO	317

- 1. To order engraved nameplates, add legend code to nameplate part number.
- 2. Character height based on the number of characters and size of nameplate. Standard character size is 3/16".
- 3. Nameplates with standard legends are the same list price as blank nameplates.
- 4. Nameplates have built-in anti-rotation feature for use with notched panel cut-outs. Additional anti-rotation ring (HW9Z-RL) is not necessary.

Nameplates Order Form — HW Series

Copy this order form and use it to specify Letter Height, Custom Engravings, Location of Engraving on Nameplate, and Quantity Desired.

To ensure engraving accuracy, fax it to your IDEC representative or Distributor.

Your Company: _____
 Name: _____
 Telephone: _____
 Fax & Email: _____

IDEC Rep/Distributor Contact: _____
 PO number (if known): _____
 IDEC Rep/Distributor Phone: _____
 IDEC Rep/Distributor Fax & Email: _____

HWAM Nameplate

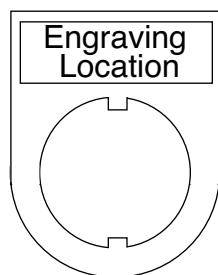

Step 1.
Choose Letter Size - 7/64" or 1/8".
 Check the box for the letter size you want. Then write your lettering in box below the check boxes. Note: 1/8" size letters cannot exceed 9 characters.

7/64" Letter Size 11 characters maximum (for 7/64" size letters)
 1/8" Letter Size 9 characters maximum (for 7/8" size letters)

1 2 3 4 5 6 7 8 9 10 11

Step 2.
Specify Quantity.
 Enter the number of nameplates desired in the box on the right.

Qty

Sample Letter Sizes
 7/64" Letters: A B C D
 1/8" Letters: A B C D

HWAQ Nameplate

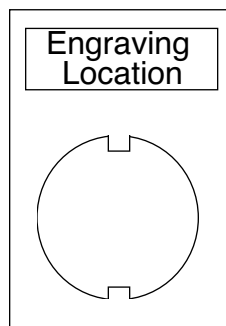

Step 1.
Choose Letter Size - 7/64" or 1/8".
 Check the box for the letter size you want. Then write your lettering in box below the check boxes. Note: 1/8" size letters cannot exceed 9 characters.

7/64" Letter Size 11 characters maximum (for 7/64" size letters)
 1/8" Letter Size 9 characters maximum (for 7/8" size letters)

1 2 3 4 5 6 7 8 9 10 11

Step 2.
Specify Quantity.
 Enter the number of nameplates desired in the box on the right.

Qty

Sample Letter Sizes
 7/64" Letters: A B C D
 1/8" Letters: A B C D

HWAS Nameplate

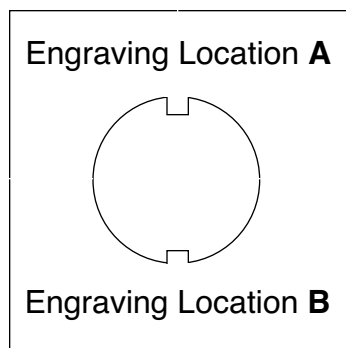

Step 1.
Choose Letter Size - 3/32" or 1/8".
 Check the box for the letter size you want. Then write your lettering in box below the check boxes. Note: 1/8" size letters cannot exceed 9 characters.

3/32" Letter Size 20 characters maximum (for 3/32" size letters)
 1/8" Letter Size 14 characters maximum (for 7/8" size letters)

1 2 3 4 5 6 7 8 9 10 11 12 13 14 15 16 17 18 19 20

Step 2.
Specify Quantity.
 Enter the number of nameplates desired in the box on the right.

Qty

Step 3.
Specify Location.
 Enter the location of engraving (A or B), in box on the right.

Location

Sample Letter Sizes
 3/32" Letters: A B C D
 1/8" Letters: A B C D

Switch Engraving Order Form – HW Series

Copy this order form and use it to specify Letter Height, Maximum Number of Lines and Text to be engraved.

To ensure engraving accuracy, fax it to your IDEC representative or Distributor.

Your Company: _____
 Name: _____
 Address: _____
 PO: _____

Telephone: _____
 Fax: _____
 Email: _____
 Part Number to be Engraved: _____

Please check one of the boxes below to indicate your choice of engraving options:

ø29mm, ø40mm Mushroom Head

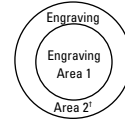

	# of Lines	Letter Height	Max. Characters Per Line
<input type="checkbox"/>	1	5/32	5
<input type="checkbox"/>		1/8	6
<input type="checkbox"/>	2	5/32	5
<input type="checkbox"/>		1/8	6
<input type="checkbox"/>	3	1/8	6
<input type="checkbox"/>	4	3/32	5

	# of Lines	Letter Height	Max. Characters Per Line
<input type="checkbox"/>	1	5/32	5
<input type="checkbox"/>		1/8	5
<input type="checkbox"/>	2	5/32	5
<input type="checkbox"/>		1/8	6
<input type="checkbox"/>	3	1/8	5
<input type="checkbox"/>	4	3/32	5

		# of Lines	Letter Height	Max. Characters Per Line
<input type="checkbox"/>	Engraving Area 1	1	5/32	5
<input type="checkbox"/>			1/8	5
<input type="checkbox"/>	Engraving Area 2	1	5/32	7
<input type="checkbox"/>			1/8	7



- Above mentioned specifications hold true for standard size pushbuttons (round and square).
- *Engraving Area 2 can be engraved for 40mm mushroom Head non-Illuminated push button only.
- Engraving is done on the button itself for non-Illuminated push buttons and on marking plate for illuminated push buttons and pilot lights.
- Please enter text exactly how you want it engraved, take care to emphasize capital or small letters.

Enter text to be engraved:

Sample Letter Sizes

1/8 Letters: **OPEN**

5/32 Letters: **OPEN**

Line 1: _____
 Line 2: _____
 Line 3: _____
 Line 4: _____

For IDEC Internal Use Only:
 Work Order #: _____

Accessories

Item	Appearance	Description/Usage	Part Number	
Locking Ring Wrench		Metallic tool used to tighten the plastic locking ring when installing the HW series in a panel	MW9Z-T1	
Lamp/LED Removal Tool		Rubber tool makes lamp/LED removal easier.	OR-55	
Anti-Rotation Ring		Prevents rotation of switches in panel. (included with all assembled switches except pilot lights)	for notched panel cutout (standard)	HW9Z-RL
			for round panel cutout	LW9Z-L
Rubber Mounting Hole Plug		Black rubber plug fills unused 7/8" mounting holes in panel.	OB-31	
Metallic Mounting Hole Plug		For plugging unused 7/8" mounting holes in the panel. Tighten the attached locking ring to a torque of 12 kfg-cm maximum Degree of protection: IP66	LW9Z-BM	
Barrier		To prevent contact between adjacent lead wires when buttons or switches are tightly mounted close together.	HW-VL1	
Pushbutton Clear Boot		Used to cover and protect pushbuttons Operating temperature: -50 to +60°C	Flush Pushbuttons	OC-31
			Extended Pushbuttons	OC-32
Padlock Cover		Plastic hinged padlockable cover to protect pushbuttons or selector switches. (Not intended for E-Stops) Degree of protection: IP65	HW9Z-KL1	
Tab Terminal Adapter		Tab #250 (6.35 x 0.8mm): Single tab	TW-FA1	
Mounting Adaptor		Used to mount round HW series (except Jumbo Mushroom, unibody, and square units) into a larger panel cut-out. (includes both pieces)	22 to 30mm	HW9Z-A30
			22 to 25mm	HW9Z-A25
Replacement Safety Lever Lock		Used to prevent contact mounting lever from moving due to heavy vibration or panel maintenance.	HW9Z-LS	
Reset Rod for Contactors Overload		5" rod used with HW1B-M0.	HW9Z-RS-TK2141	
Replacement Operator Washer		Provided with operator. Insert between bezel and locking ring.	HWM-WASHER	
Replacement Locking Ring		Plastic locking nut comes with all HW operators & assemblies.	Standard (plastic)	HW9Z-LN
			Optional (metal)	HW9Z-LNM
Switch Cover (Square)		Used only with round or square flush pushbuttons.	HW9Z-K1 (spring return) HW9Z-K11 (maintained cover)	
Replacement Keys		Pair of Keys (#231)	HW9Z-SKP	

Switches & Pilot Devices

Signaling Lights

Relays & Sockets

Timers

Contactors

Terminal Blocks

Circuit Breakers

Switches & Pilot Devices

Signaling Lights







Relays & Sockets

Timers



Contactors



Terminal Blocks

Circuit Breakers

Item	Appearance	Description/Usage	Part Number
Replacement Lens		HW Illuminated Unibody Replacement Lens	HWLV-LENSR
Replacement Jumbo Dome Lens		Polycarbonate Replacement Lens (If using yellow lens, use white LED.)	HW1A-P5Ⓞ Ⓞ = (A, G, R, S, W, Y)
Replacement Jumbo LED Diffusing Lens			HW9Z-PP5C
Replacement LED Lamps for HW Jumbo Dome		Replacement LED Lamp - applicable for jumbo pilot lights only	LSTDB-2Ⓞ Ⓞ = (A, G, R, S, W)
Rubber Cover for Dual Pushbuttons		Clear Silicon rubber cover	HW9Z-D7D
Barrier for Dual Pushbuttons		Plastic barrier. Used when mounting the HW7 units on 30mm horizontal centers, to prevent possible interconnections between adjoining terminals.	HW-VG1
EMO Sticker		Emergency stop nameplate sticker	HW9Z-EMO-NP-TK2120

E-Stop Shrouds

Style	Part Numbers	E-Stop Types	Applicable Standards
	HW9Z-KG1	40mm Mushroom Head	SEMI S2-0703, 12.5.1 Compliant
	HW9Z-KG2	40mm, and 60mm Mushroom Head	SEMI S2-0703, 12.5.1 & SEMATECH Compliant

Style	Part Numbers	E-Stop Types	Applicable Standards
	HW9Z-KG3	40mm Mushroom Head	SEMI S2 Compliant (Approved by TUV)
	HW9Z-KG4	40mm Mushroom Head	SEMI S2 Compliant (Approved by TUV) & SEMATECH

Contact Assemblies

Standard Contact Assemblies

For use with Non-Illuminated Pushbuttons & E-Stops

Style	Contacts	Part Number
	1NO	HW-CBF10
	1NC	HW-CBF01
	1NO/1NC	HW-CBF11
	2NO	HW-CBF20
	2NC	HW-CBF02
	2NO/2NC	HW-CBF22
	1NO	HW-CB10
	1NC	HW-CB01
	1NO/1NC	HW-CB11
	2NO	HW-CB20
	2NC	HW-CB02
	2NO/2NC	HW-CB22

Full Voltage Contact Assemblies

For use with Illuminated Pushbuttons.

Style	Contacts	Part Number
	1NO	HW-FL10Q0
	2NO	HW-FL20Q0
	1NO/1NC	HW-FL11Q0
	1NC	HW-FL01Q0
	2NC	HW-FL02Q0



Order lamp separately.



Gold contact option is available for spring-up terminals. Add suffix "MAU" to end of part number. For example, HW-CB20 becomes HW-CB20-MAU.

Transformer Contact Assemblies

For use with Illuminated Pushbuttons.

Style	Contacts	Part Number
120V AC with LED	1NO	HW-FL10H2-Ⓢ
	2NO	HW-FL20H2-Ⓢ
	1NC	HW-FL01H2-Ⓢ
	1NO/1NC	HW-FL11H2-Ⓢ
240V AC with LED	1NO	HW-FL10M4-Ⓢ
	2NO	HW-FL20M4-Ⓢ
	1NC	HW-FL01M4-Ⓢ
	1NO/1NC	HW-FL11M4-Ⓢ
480V AC with LED	1NO	HW-FL10T8-Ⓢ
	2NO	HW-FL20T8-Ⓢ
	1NC	HW-FL01T8-Ⓢ
	1NO/1NC	HW-FL11T8-Ⓢ
120V AC with Incandescent	1NO	HW-FL10H2
	2NO	HW-FL20H2
	1NC	HW-FL01H2
	1NO/1NC	HW-FL11H2
240V AC with Incandescent	1NO	HW-FL10M4
	2NO	HW-FL20M4
	1NC	HW-FL01M4
	1NO/1NC	HW-FL11M4



- In place of Ⓢ, specify the LED Color Code.
Ⓢ = A, G, R, S, or W
- 6V LED or incandescent lamp included.

Dimensions (mm)

Non-Illuminated Pushbuttons

Flush (HW1B-M1, -A1)

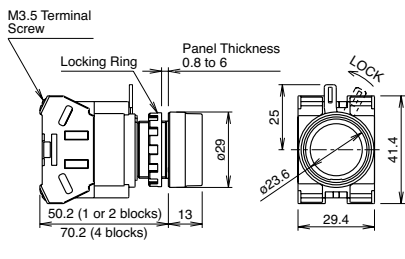

Extended (HW1B-M2, -A2)

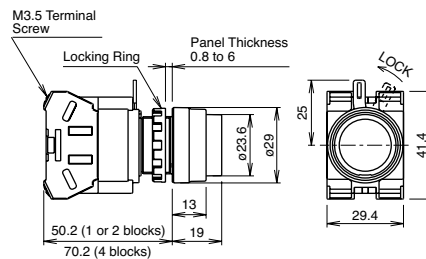

ø29mm Mushroom (HW1B-M3 -A3)

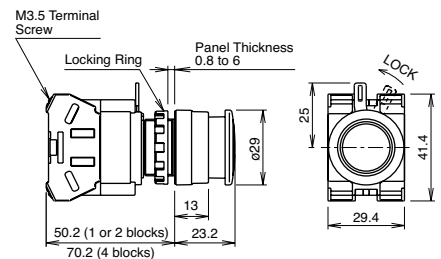

ø40mm Mushroom (HW1B-M4, -A4)

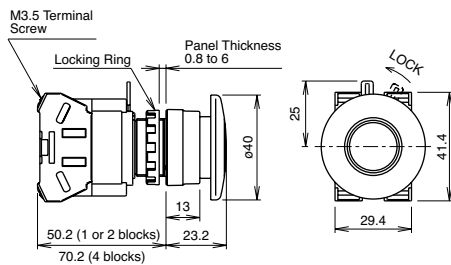

ø60mm Mushroom (HW1B-M5)

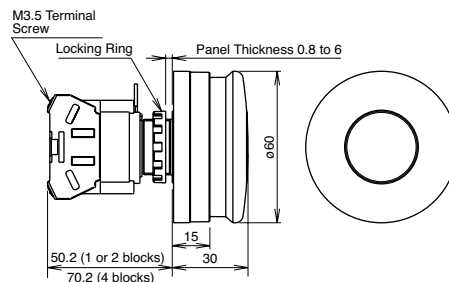

Square Flush (HW2B-M1, -A1)

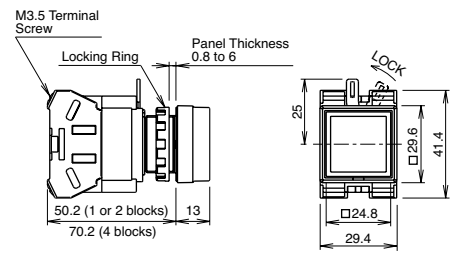

Square Extended (HW2B-M2, -A2)

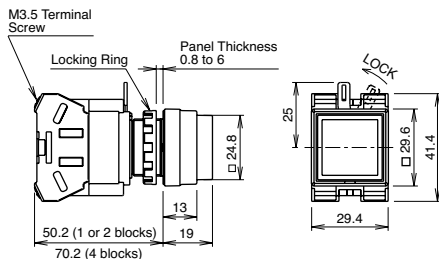

Contact Block (Bottom View)

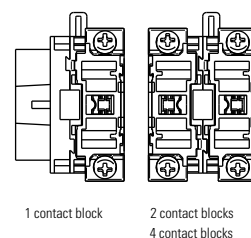

Terminal Wiring

Arrows indicate access directions for wiring

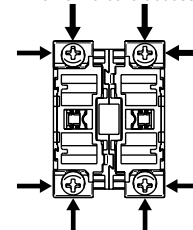

Operators

Dimensions (mm)

Flush (Round & Square)

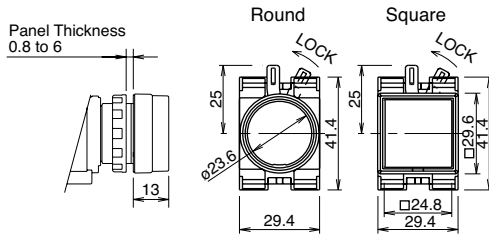

Extended

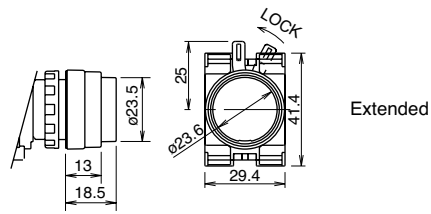

Extended with Full Shroud

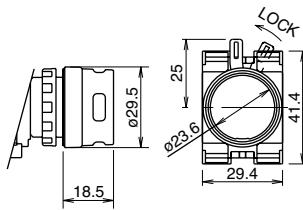

ø40mm Mushroom

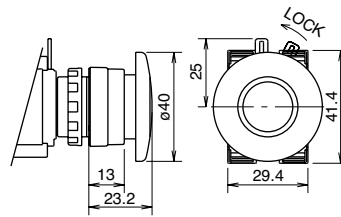

Emergency Stop Pushbuttons

Dimensions (mm)

ø29mm Head Pushlock Turn Reset (HW1B-V3)

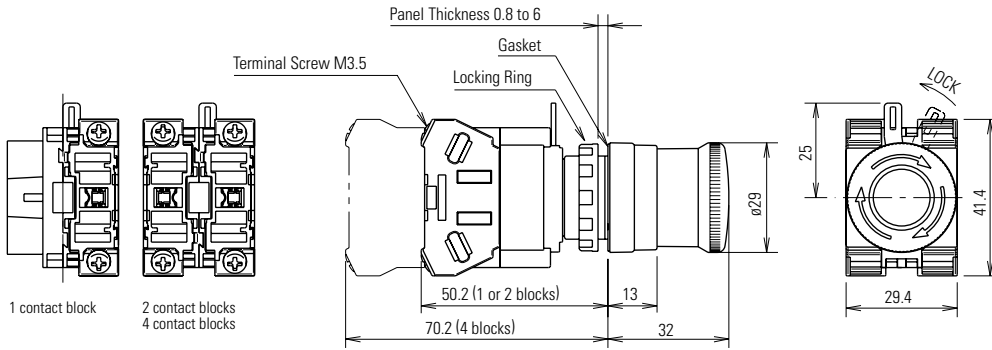

ø40mm Head Pushlock Turn Reset (HW1B-V4)

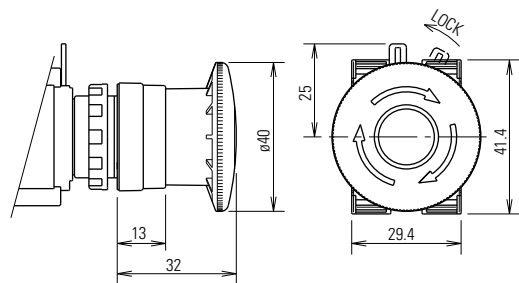

ø40mm Head EMO Pushlock Turn Reset (HW1B-V4)

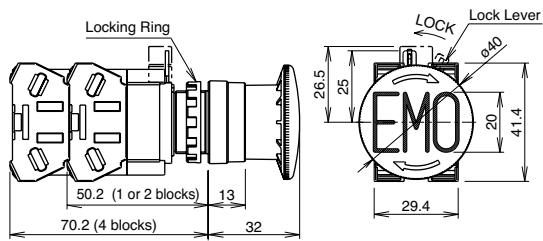

ø40mm Head Pushlock Key Reset (HW1B-X4)

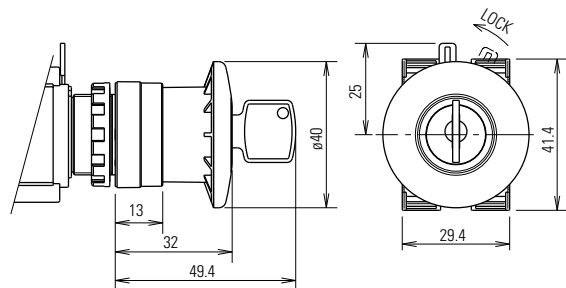

ø60mm Head Pushlock Turn Reset (HW1B-V5)

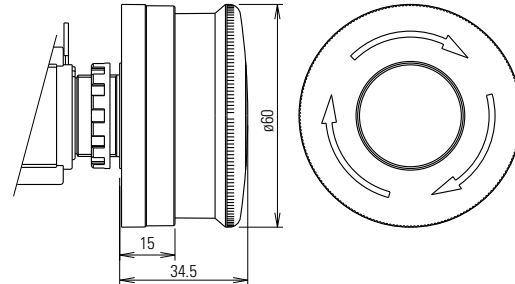

ø40mm Head Push-Pull (HW1B-Y2)

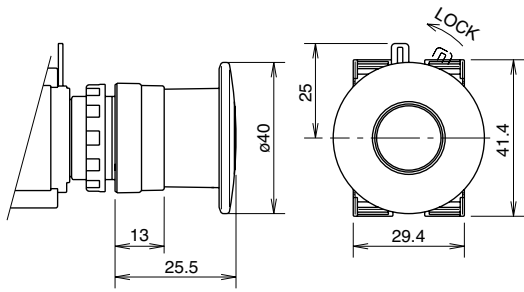

ø40mm Head Unibody Pushlock Turn Reset (HW1B-BV4)

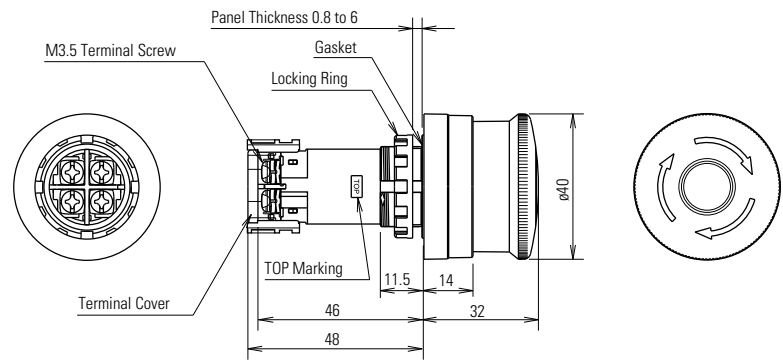

Illuminated E-Stop Pushbuttons (HW1E-LV4)

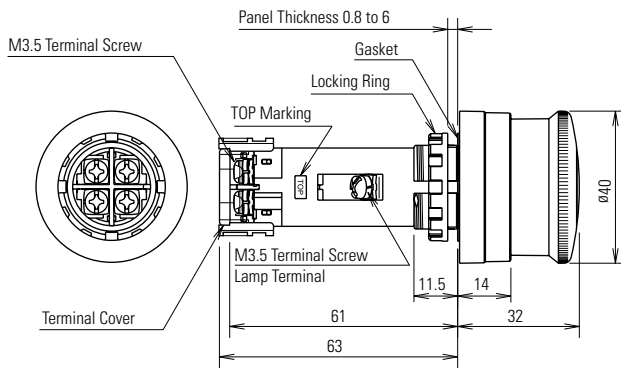

Mounting Hole

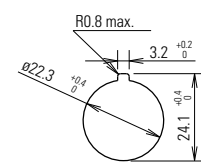

The minimum mounting centers shown below are applicable to E-Stop switches with one layer of contact blocks (two contact blocks). When two layers of contact blocks are mounted, determine the minimum mounting centers for ease of wiring.

Unit	Vertical Spacing	Horizontal Spacing
HW1B-V3 HW1B-V4 HW1B-X4 HW1B-Y2	50 mm	50 mm
HW1B-V5	60 mm	60 mm

Terminal Arrangement (Bottom View)

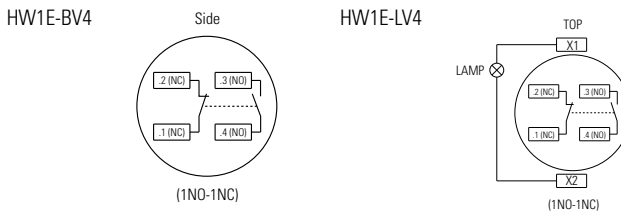

Emergency Stop Stations

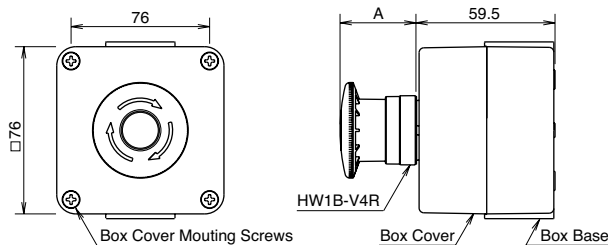

Operator	Dimension A (mm)
Pushlock Turn Reset	32
Pushlock Key Reset	32 (Key inserted: 49.4)
Push Pull	25.5

Dimensions (mm)

Mounting Hole Layout

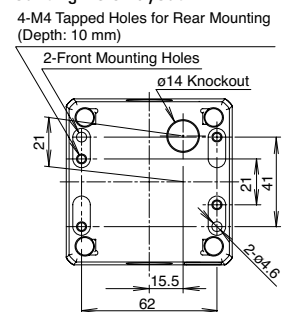

Pilot Lights

Full Voltage

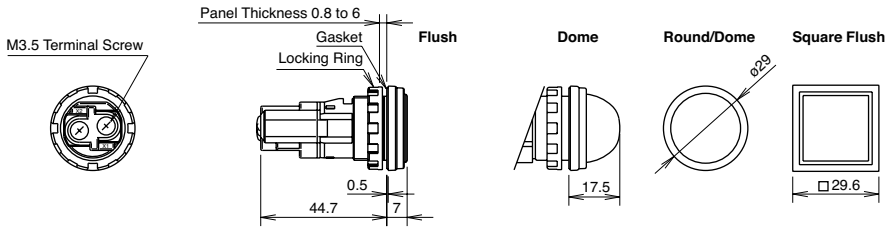

Transformer

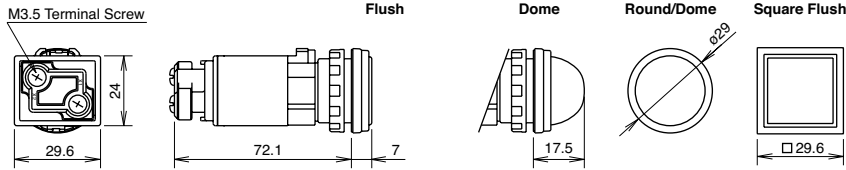

Mounting Hole Layout

Close mounting on 30mm centers
Degree of protection: IP65

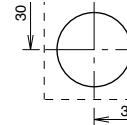

DC-DC Converter

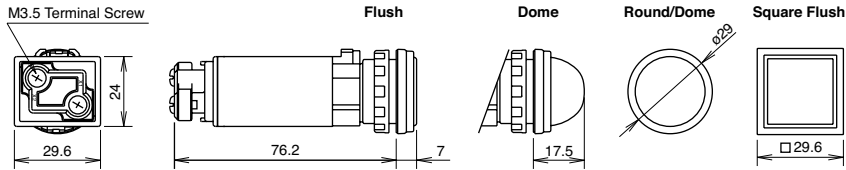

When mounting transformer or DC-DC converter type units on 30mm centers vertically and horizontally, keep the ambient temperature below 40°C.

Jumbo Dome Pilot Lights

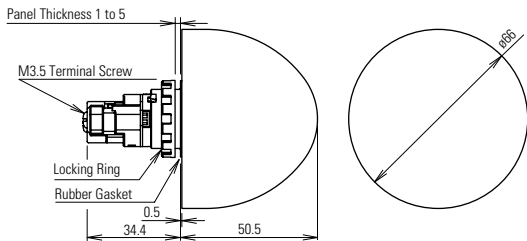

LED Lamp LSTDB

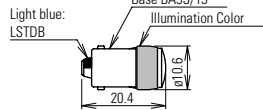

Incandescent Lamp LSB

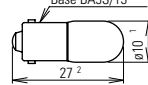

Mounting Hole Layout

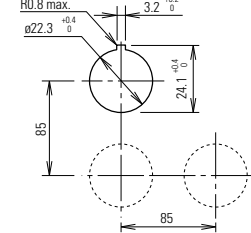

Illuminated Pushbuttons

Full Voltage Models

1 Contact Block

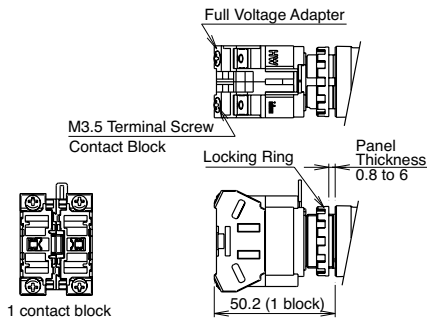

2 Contact Blocks

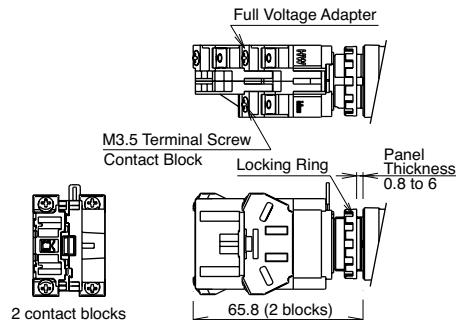

3 Contact Blocks

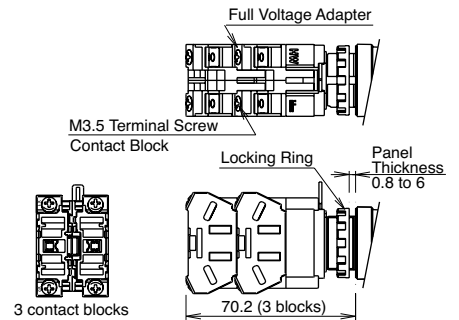

Dimensions (mm)

Illuminated Pushbuttons con't

4 Contact Blocks

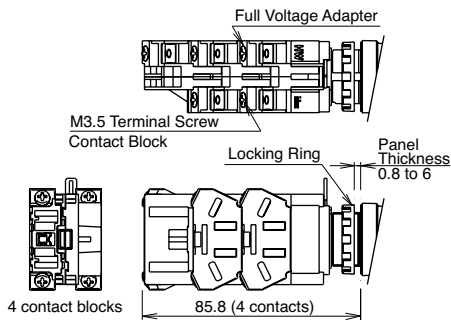

Terminal Wiring

Arrows indicate access directions for wiring.

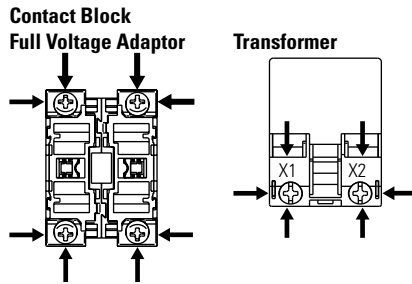

Transformer Models

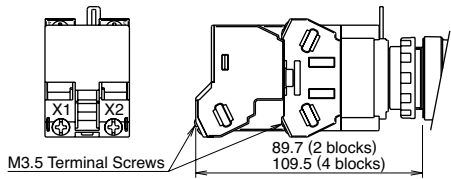

DC-DC Converter Models

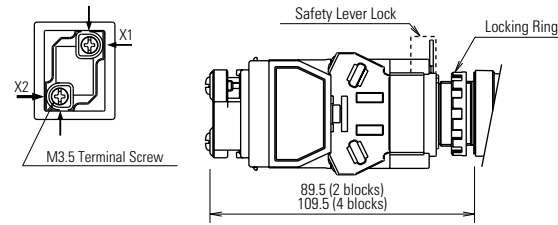

Non-Illuminated Selector & Key Switches

Dimensions (mm)

Knob Operator

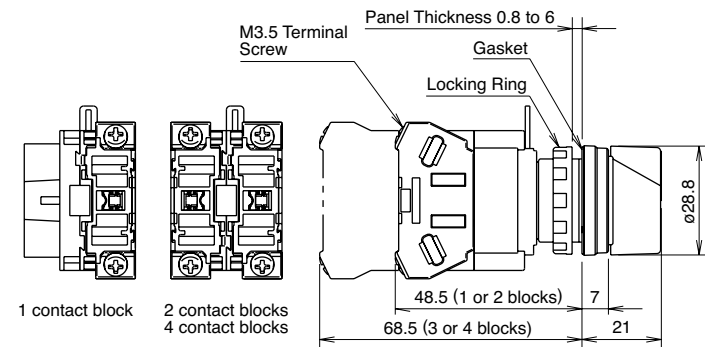

Terminal Wiring

Arrows indicate access directions for wiring.

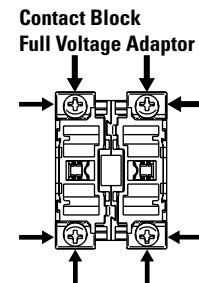

Key Operator

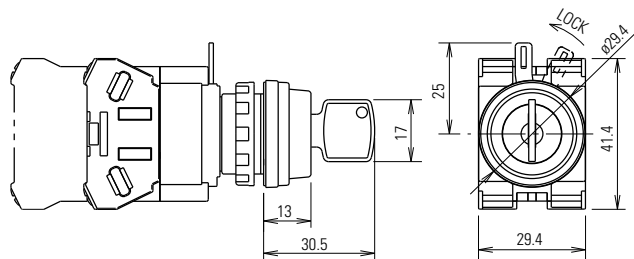

Transformer

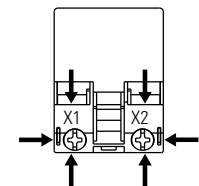

Illuminated Selector Switches

Full Voltage Model

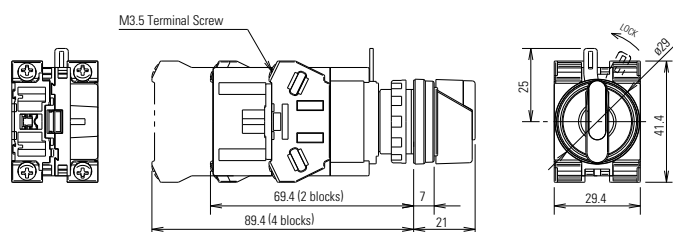

Transformer Model

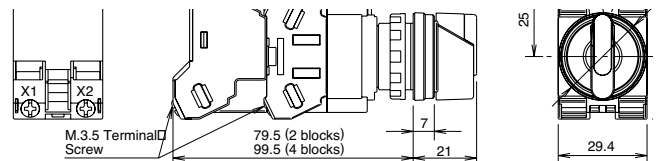

Dual Pushbutton

Without Pilot Light

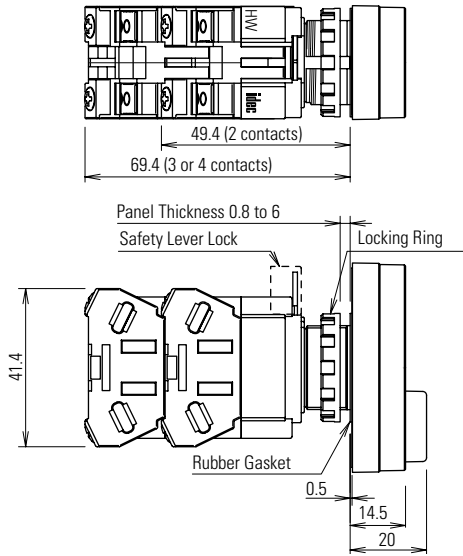

Without Button Markings

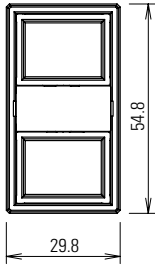

With Button Markings (I/ON and O/OFF)

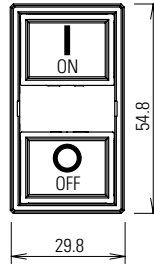

With Pilot Light

Full Voltage

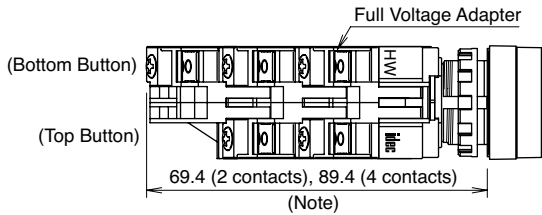

The depth of a 3-contact model depends on the combination of contact blocks at top and bottom pushbuttons.

Top Button	1 contact block	2 contact blocks
Bottom Button	2 contact blocks	1 contact block
Depth	89.4 mm	69.4 mm

Transformer (240V minimum)

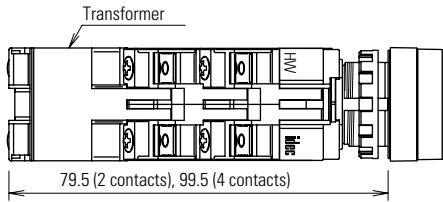

Transformer (480V)

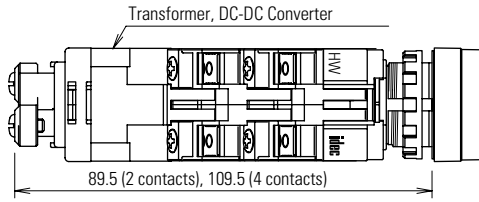

Monolever

Dimensions (mm)

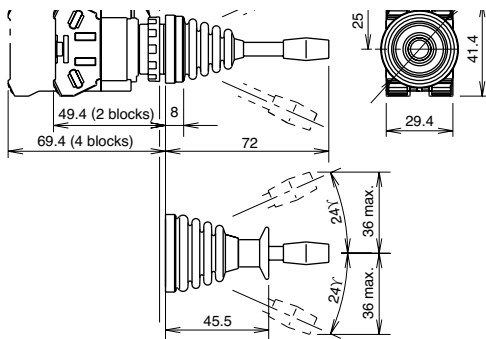

Dimensions (mm)

Mounting Hole Layout

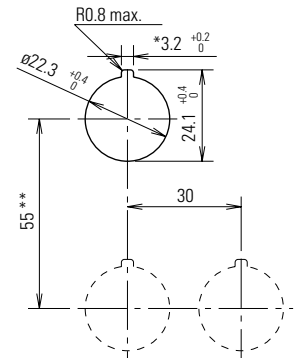

-The 3.2 mm recess is for preventing rotation and is not necessary when a nameplate or anti-rotation ring is not used.

-When using the safety lever lock, determine the vertical spacing in consideration of convenience for installing and removing the safety lever lock.

-Recommended vertical spacing: 100 mm
 -The minimum mounting centers are applicable to switches with one layer of contact blocks (two contact blocks). When two layers of contact blocks are mounted, determine the minimum mounting centers for ease of wiring.

Accessory Dimensions

LW9Z-BM
Metallic Mounting Hole Plug

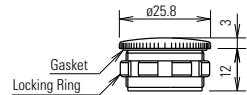

OB-31
Rubber Mounting Hole Plug

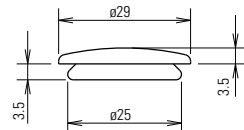

HW9Z-RL
Anti-Rotation Ring

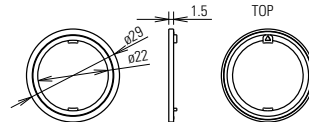

OR-55
Lamp/LED Removal Tool

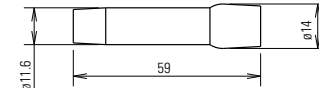

HW9Z-D7D
Dual Pushbutton Rubber Cover

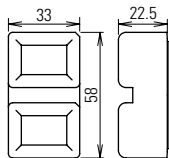

HW-VG1
Dual Pushbutton Barrier

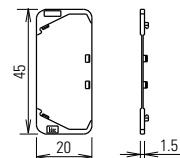

MW9Z-T1
Locking Ring Wrench

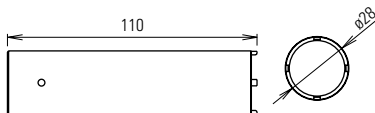

HW-VL1
Barrier

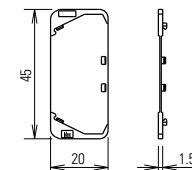

HW9Z-KL1
Padlock Cover

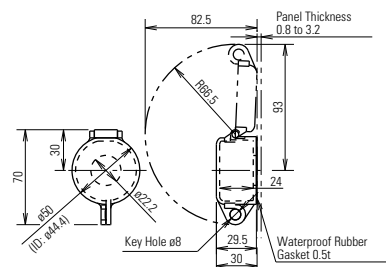

HWLS-TK1971
Safety Lever Lock

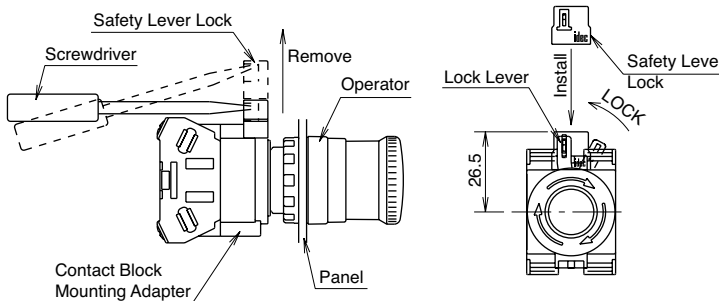

HW9Z-KG1

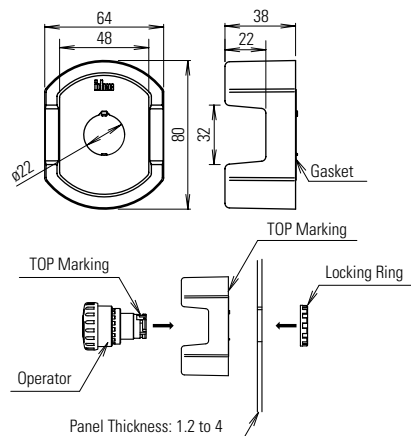

HW9Z-KG2

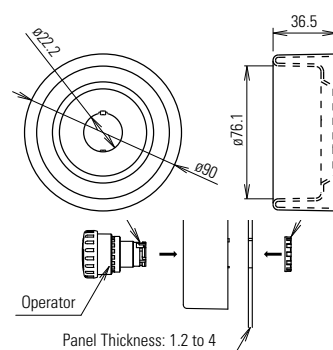

HW9Z-KG3

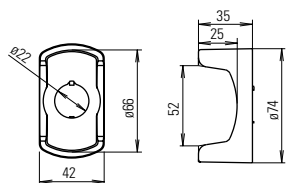

HW9Z-KG4

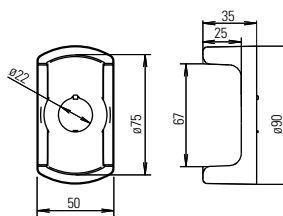

LSTD

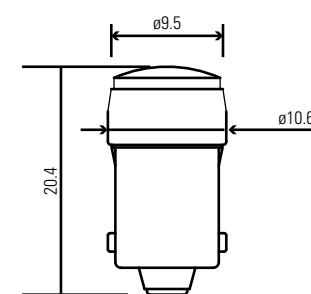

Specification Charts

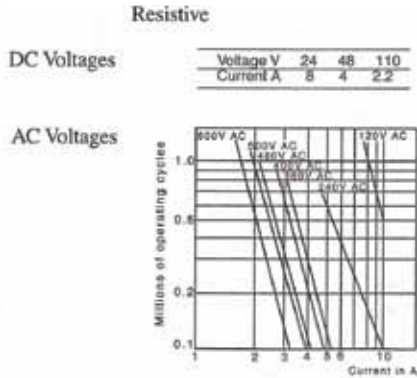
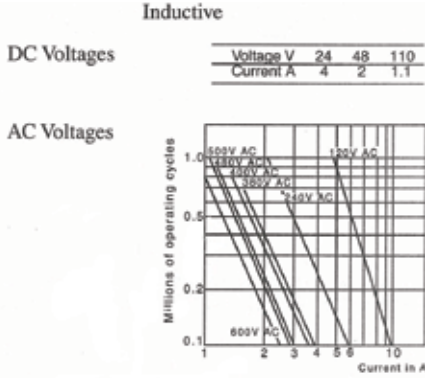

Conforming to IED 947-5-1 Appendix C.
Utilization categories AC-15 and DC-13.
Operation rate: 1,800 op. hour
Load factor:
Inductive 0.4 ± 0.05
Resistive 0.9 ± 0.05

Operator Truth Tables

2 Position Selector Switches

	Contact	Mounting Position	Operator Position	
			Left	Right
			HW1S-2T HW1K-2* HW1F-2	HW-F10 (NO)
HW-F01 (NC)	L: X, R: X	Left: 0, Right: 0		
HW-F10R (NO-EM)	L: 0, R: 0	Left: X, Right: X		
HW-F01R (NC-LB)	L: X, R: X	Left: 0, Right: 0		

3 Position Selector Switches con't

	Contact	Mounting Position	Operator Position		
			Left	Center	Right
			HW1S-3JT HW1K-3J*	HW-F10 (NO)	L: X, R: 0
HW-F01 (NC)	L: 0, R: 0	Left: X, Center: X, Right: 0			
HW-F10R (NO-EM)	L: X, R: X	Left: 0, Center: 0, Right: X			
HW-F01R (NC-LB)	L: 0, R: X	Left: X, Center: X, Right: 0			

3 Position Selector Switches

	Contact	Mounting Position	Operator Position		
			Left	Center	Right
			HW1S-3T HW1K-3* HW1F-3	HW-F10 (NO)	L: X, R: 0
HW-F01 (NC)	L: 0, R: X	Left: X, Center: X, Right: 0			
HW-F10R (NO-EM)	L: X, R: 0	Left: 0, Center: 0, Right: X			
HW-F01R (NC-LB)	L: 0, R: X	Left: X, Center: X, Right: 0			

4 Position Selector Switches

	Contact	Mounting Position	Operator Position			
			1	2	3	4
			HW1S-4T	HW-F10 (NO)	L: X, R: 0	1: 0, 2: 0, 3: 0, 4: X
HW-F01 (NC)	L: 0, R: 0	1: X, 2: X, 3: 0, 4: 0				
HW-F10R (NO-EM)	L: X, R: X	1: 0, 2: 0, 3: X, 4: X				
HW-F01R (NC-LB)	L: 0, R: X	1: X, 2: X, 3: X, 4: 0				

5 Position Selector Switches

	Contact	Mounting Position	Operator Position				
			1	2	3	4	5
			HW1S-5T	HW-F10 (NO)	L: X, R: 0	1: 0, 2: 0, 3: 0, 4: 0, 5: X	
HW-F01 (NC)	L: 0, R: 0	1: X, 2: X, 3: 0, 4: 0, 5: 0					
HW-F10R (NO-EM)	L: X, R: X	1: 0, 2: 0, 3: X, 4: X, 5: X					
HW-F01R (NC-LB)	L: 0, R: X	1: X, 2: X, 3: X, 4: X, 5: 0					

1. Mounting position indicates which side of operator each contact should be mounted (as viewed from the front of the panel).
2. *For key removable code see page 579.

3. HW1S-3T is identified by white plungers on the operator.
4. HW1S-3ST is identified by red plungers on the operator.
5. HW1S-3JT is identified by black plungers on the operator.

HW Safety Precautions

Turn off power to HW series control units before starting installation, removal, wiring, maintenance, and inspection of the products. Failure to turn power off may cause electrical shocks or fire hazard.

To avoid the possibility of burning yourself, use the lamp holder tool when replacing lamps.

For wiring, use wires of a proper size to meet voltage and current requirements. Tighten the M3.5 terminal screws to a tightening torque of 1.0 to 1.3 N-m. Failure to tighten terminal screws may cause overheating and fire.

HW General Instructions

Panel Mounting

Remove the contact block assembly from the operator (for transformer type pilot lights, remove the transformer from the illumination unit). Remove the locking ring from the operator. Insert the operator into the panel cut-out from the front, tighten the locking ring from the back, then install the contact block assembly to the operator.

Removing and Installing the Contact Block Assembly

1. To remove the operator from the contact block, turn the locking lever in the direction of the arrow shown below. The operator can now be removed.
2. To reinstall, place the TOP markings on the operator and the contact block mounting adapter in the same direction, and insert the operator into the contact block mounting adapter. Then turn the locking lever in the opposite direction.

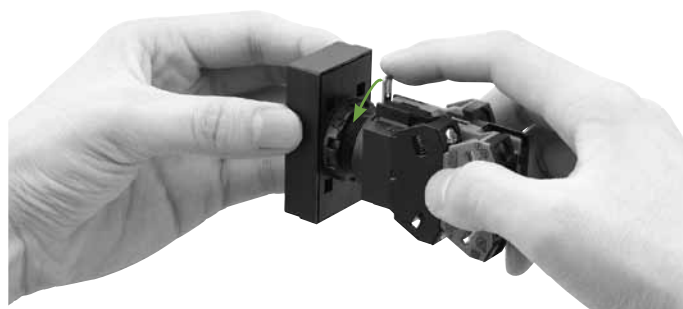

Notes for Panel Mounting

1. When mounting the operator onto a panel, use the optional locking ring wrench (MW9Z-T1) to tighten the locking ring. Tightening torque must not exceed 2.0 N-m. Do not use pliers. Excessive tightening will damage the locking ring.
2. For the contact blocks and transformers housing LED and incandescent lamps, make sure not to press the lamps too hard, otherwise the lamp socket may be damaged.

Safety Lever Lock

IDEC strongly recommends using the safety lever lock (HW9Z-LS, yellow) to prevent heavy vibration or maintenance personnel from unlocking the contact assembly.

1. HW series can be mounted vertically with a minimum spacing of 55 mm but spacing should be determined to ensure easy operation (recommended minimum spacing: 100 mm).
2. Mount the control unit onto the panel, lock the lever, and push in the safety lever lock to install.
3. When the spacing is narrower than the recommended value, with the lever unlocked, mount the safety lever lock and insert the contact unit to the operator. Then, lock the lever and strongly push in the safety lever lock to install.
4. To remove the safety lever lock, insert a flat screwdriver into the safety lever and push upwards.

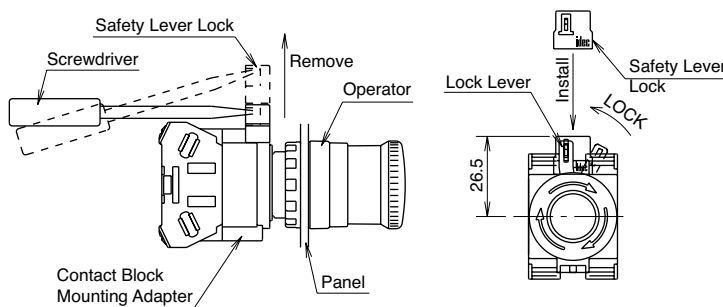

Dual Pushbutton Instructions

Replacement of Lens

Removing

Remove the lens by inserting a screwdriver into the recess of the lens through the bezel.

Installing

Install the lens in the recess between the buttons by pressing against the bezel.



Dual Pushbuttons Instructions con't

Replacement of Lamps

Lamps can be replaced by using the lamp holder tool (OR-55) from the front of the panel, or by removing the contact block assembly from the operator unit.

Removing the Lamps from the Front of the Panel

Removal

1. To remove, slip the lamp holder tool onto the lamp head lightly. Then push slightly, and turn the lamp holder tool counterclockwise.



Installation

1. To install, insert the lamp head into the lamp holder tool, and hold the lamp as shown in the figure below.
2. Place the pins on the lamp base to the grooves in the lamp socket. Insert the lamp and turn it clockwise.

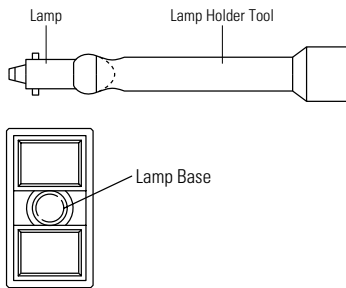

About Pushbutton Switches

The pushbuttons cannot be removed or replaced!

Do not attempt to remove using a flat screwdriver or pliers, otherwise the pushbuttons may be damaged.

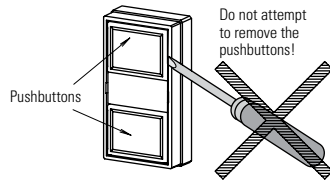

Narrow Mounting

When mounting the units closely in a horizontal row on 30mm centers, use optional barriers to prevent interconnection between adjoining terminals. The barriers can be attached simply by pressing them onto the sides of contact blocks.



When mounting transformer type illuminated units closely in a horizontal row on 30-mm centers, insert solid wires or stranded wires into inside of the terminal screw on the transformer (see figure on the right) to prevent short circuit between adjoining terminals.

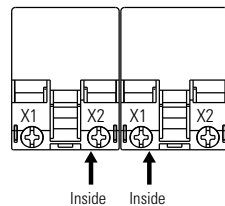

Tightening Torque for Terminal Screws

Tighten the M3.5 terminal screws to a torque of 1.0 to 1.3 N·m.

Installation of LED Illuminated Units

When using full voltage type LED illuminated units, provide protection against electrical noise, if necessary.

Applicable Wiring

The applicable wire size is 2 mm² maximum. (solid wire ø1.6mm² maximum) One or two wires can be connected.

Applicable Crimping Terminal

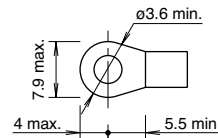

Be sure to use an insulation tube or cover on the crimping part of the crimping terminal to prevent electrical shocks.

Solid Wire

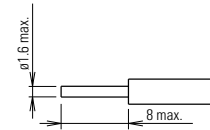

Note: When connecting wires to contact blocks or transformers in the direction shown below, keep the insulation stripping length 6.6 mm at the maximum.

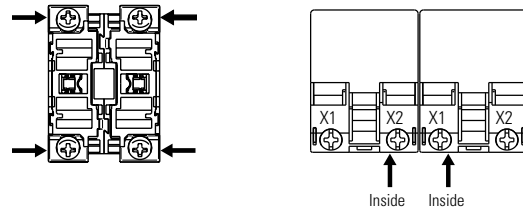

Installing the Rubber Cover

When using the HW7D pushbuttons in places where the pushbuttons are subjected to water splash or an excessive amount of dust, make sure to use the HW9Z-D7D rubber boot (IP65) which is ordered separately.

Notes for Installing the Rubber Cover

Remove the gasket from the operator, and install the rubber boot on the operator. Pull out the seals of the rubber boot and place them around the operator sleeve as shown. Make sure that the seals are not twisted or tucked inside and that the gasket does not remain, otherwise the normal waterproof and dustproof characteristics are not ensured.

1. Remove the gasket.
2. Install the rubber boot on the pushbuttons.
3. Rubber boot is installed.

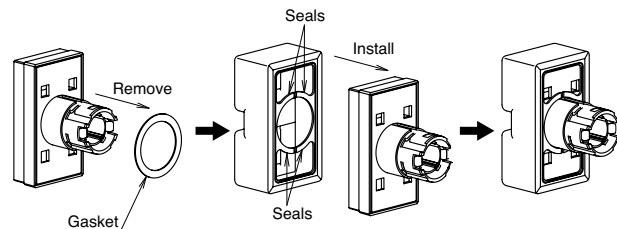

X-ON Electronics

Largest Supplier of Electrical and Electronic Components

Click to view similar products for [Switch Fixings](#) category:

Click to view products by [Idec](#) manufacturer:

Other Similar products are found below :

[893102000](#) [00-5150](#) [LZZ1A](#) [0098.9234](#) [61-9451.0](#) [M2PA-5011](#) [630155](#) [635401](#) [6PA113](#) [6PA147-E6](#) [6PA148-E6](#) [6PA32](#) [6PA9](#) [700106](#)
[700109](#) [700303A56](#) [700C1GRY](#) [700C2GRN](#) [704-6001](#) [704.960.9](#) [704.965.2](#) [704.965.6](#) [704.966.0](#) [7089-3](#) [710082-B11](#) [71M1048](#)
[757200264](#) [764300000](#) [MHU35](#) [MHU37](#) [807039-1](#) [825.003.011](#) [825.005.011](#) [825.053.011](#) [825.055.011](#) [826.000.071](#) [827.020.011](#)
[827.400.021](#) [835.900.023](#) [MML52C10C](#) [MML52E10C](#) [MML92HGH](#) [MML93K](#) [84211M02CNNS](#) [84212M02CNNS](#) [84217A8.0LNOS](#)
[842.500.011](#) [843187-000](#) [843487-000](#) [84-901](#)