

PS3L Series Metal Frame Switching Power Supplies

Key features of the PS3L series include:

- Metal frame
- Wide power range: 10W-300W
- Universal input:
10W-30W: 85-264V AC/105-370V DC
50W-300W: 85-264V AC/105-350V DC
- Screw terminals, IP20 (fingersafe)
- Power Factor Protection
EN61000-3-2
EN61000-3-3 (50W to 300W models)
- Overcurrent/overvoltage protection
- Voltage +10% adjustment
- DIN rail or panel surface mount
- Approvals:
CE marked
UL508 listed
EN50178 compliant
EMC Directives
EN50081-2
EN61000-6-2
LVD EN60950:2000



Item	Watts	Rated Voltage	Rated Current	Part Number
	10	5V DC	2A	PS3L-A05AFF
		12V DC	0.9A	PS3L-A12AFF
		24V DC	0.5A	PS3L-A24AFF
	15	5V DC	3A	PS3L-B05AFF
		12V DC	1.4A	PS3L-B12AFF
		24V DC	0.7A	PS3L-B24AFF
	30	5V DC	6A	PS3L-C05AFF
		12V DC	2.5A	PS3L-C12AFF
		24V DC	1.3A	PS3L-C24AFF
	50	12V DC	4.3A	PS3L-D12AFF
		24V DC	2.2A	PS3L-D24AFF

Item	Watts	Rated Voltage	Rated Current	Part Number
	100	12V DC	8.5A	PS3L-E12AFF
		24V DC	4.5A	PS3L-E24AFF
	150	12V DC	13A	PS3L-F12AFF
		24V DC	6.5A	PS3L-F24AFF
	300	24V DC	12.5A	PS3L-G24AFF

PLCs

Operator Interfaces

Automation Software

Power Supplies

Sensors

Communication & Networking

Specifications

Type		PS3L-A (10W)	PS3L-B (15W)	PS3L-C (30W)	PS3L-D (50W)	PS3L-E (100W)	PS3L-F (150W)	PS3L-G24 (300W)		
Input	Input Voltage (Single-phase two-wire)	100 to 240V AC (Voltage range: 85 to 264V AC/105 to 370V DC)			100 to 240V AC (Voltage range: 85 to 264V AC/105 to 350V DC)					
	Frequency (AC input only)	47 to 63Hz								
	Input Current (Typical)	100V	0.25A	0.37A	0.68A	0.68A	1.4A	2.0A	3.8A	
		200V	0.16A	0.23A	0.45A	0.34A	0.65A	0.95A	2.0A	
	Inrush Current (Cold start)	100V	20A max.	20A max.	20A max.	30A max.	30A max.	30A max.	30A max.	
		200V	40A max.	40A max.	40A max.	60A max.	60A max.	60A max.	60A max.	
	Leakage Current	0.75 mA max. (60Hz; UL, CSA, VDE)								
Power Factor (Typical)	—				0.99 (100V AC input, rated output), 0.95 (200V AC, rated output)					
Efficiency (Typical)	5V DC:	70%	73%	75%	—	—	—	—		
	12V DC:	74%	75%	77%	76%	78%	80%	—		
	24V DC:	78%	78%	79%	79%	81%	83%	81%		
Output	Rated Voltage/Current	5V/2A	5V/3A	5V/6A	—	—	—	—		
		12V/0.9A	12V/1.4A	12V/2.5A	12V/4.3A	12V/8.5A	12V/13A	—		
		24V/0.5A	24V/0.7A	24V/1.3A	24V/2.2A	24V/4.5A	24V/6.5A	24V/12.5A		
	Adjustable Voltage Range	±10% (V.ADJ control on front)								
	Output Holding Time	20msec minimum (at the rated input and output)								
	Start Time	200msec maximum (at the rated input and output)				500msec maximum (at the rated input and output)				
	Rise Time	100msec maximum (at the rated input and output)				200msec maximum (at the rated input and output)				
	Regulation	Input Fluctuation	5V: 20mV maximum, 12V: 48mV maximum, 24V: 96mV maximum							
		Load Fluctuation	5V: 40mV maximum, 12V: 100mV maximum, 24V: 150mV maximum							
		Temperature Change (-10 to +50°C)	5V: 50mV maximum 12V: 120mV maximum 24V: 240mV maximum				5V: 60mV maximum 12V: 150mV maximum 24V: 290mV maximum			
Ripple Voltage			-10 to 0°C						200 mV maximum ¹	
		0 to +50°C						5V: 120mV maximum, 12V/24V: 150mV maximum ¹		
Supplementary Functions	Overcurrent Protection	105% (Typical), Automatic reset ²								
	Overvoltage Protection	120% min. ³	Output off at 120%, reset when input voltage is restored. ⁴							
	Operation Indicator	LED (green)								
Dielectric Strength		Between input and output terminals: 3,000V AC, 1 minute Between input terminal and housing: 2,000V AC, 1 minute Between output terminal and housing: 500V AC, 1 minute								
Insulation Resistance		Between input and output terminals: 100MW minimum (500V DC megger) Between input terminal and housing: 100MW minimum (500V DC megger)								
Operating Temperature ⁵		-10° to +70°C				-10° to +60°C		-10° to +65°C		
Storage Temperature		-30° to +75°C								
Operating Humidity		20 to 90% RH (no condensation, no freezing)								
Vibration Resistance		10 to 55Hz, 20m/s ² constant, sweep cycle 1 minute, 2 hours each in 3 axes								
Shock Resistance		200m/s ² , 11ms, 1 shock each in 3 axes								
Dimensions H X W X D (mm)		97 x 35 x 86	97 x 35 x 86	96 x 35 x 114.5	97 x 37 x 147.5	97 x 54 x 200	97 x 62 x 200	158 x 63 x 230		
Weight (Approx.)		240g	250g	340g	350g	630g	730g	1550g		
Terminal Screw		M4 slotted-Phillips head screw (screw terminal type)								

- 1. Including noise. Measured at the terminal block according to EIAJ.
- 2. Protection against short-circuit and overcurrent of 30 seconds maximum. Overload for 30 seconds or longer may damage the internal elements.
- 3. Zener limiter method
- 4. Turn the input off and after one minute, turn the input on again.
- 5. Refer to the derating characteristics. No freezing. The maximum temperature is the temperature at 100% output current (natural air-cooling) in the derating characteristics.

PLCs

Operator Interfaces

Automation Software

Power Supplies

Sensors

Communication & Networking

Characteristics

Operating Temperature vs. Output Current Characteristics (Derating Curves)

PS3L-A/B/C/D

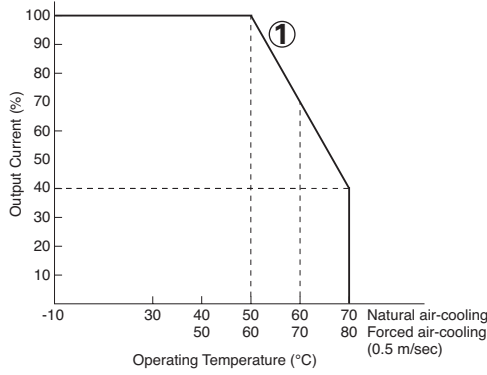

Conditions: At rated input/output (operating temperature is the temperature around the power supply)

① Mounting Directions A and B

PS3L-E/F

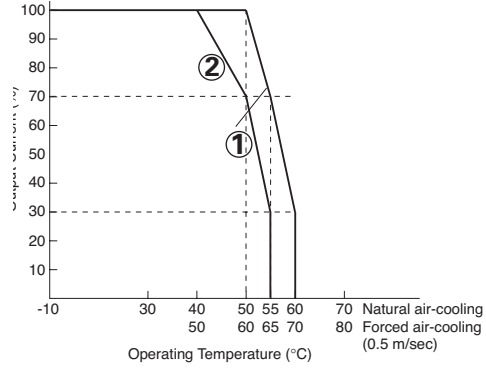

Conditions: At rated input/output (operating temperature is the temperature around the power supply)

① Mounting Direction A
② Mounting Direction B

PS3L-G

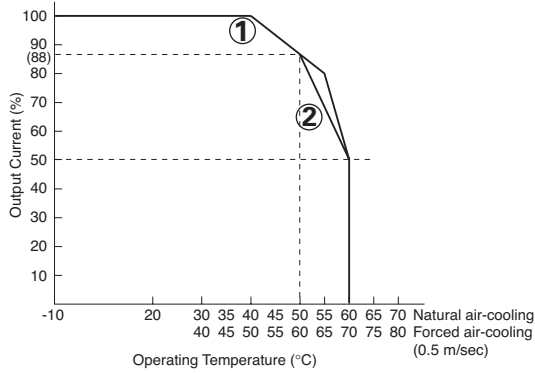

Conditions: At rated input/output (operating temperature is the temperature around the power supply)

① Mounting Direction A
② Mounting Direction B

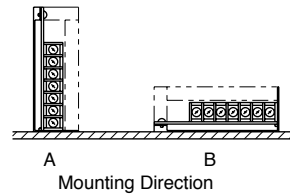

Overcurrent Protection Characteristics

PS3L-A/B

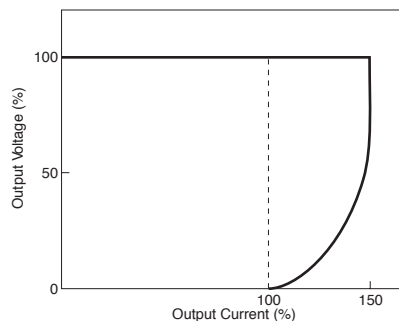

PS3L-C/D/E/F/G

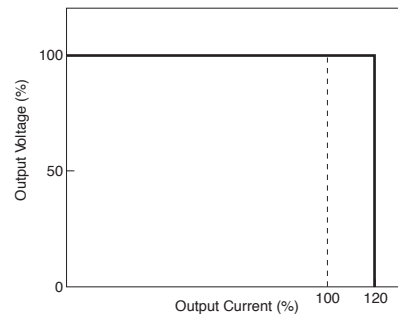

PLCs

Operator Interfaces

Automation Software

Power Supplies

Sensors

Communication & Networking

Terminal Markings

PS3L-A/B

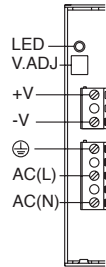

PS3L-C/D

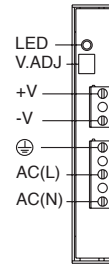

PS3L-E/F

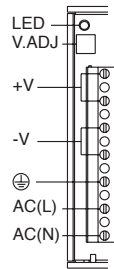

PS3L-G

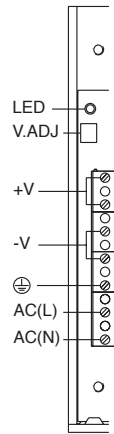

Marking	Name	Description
V.ADJ	Output Voltage Adjustment	Allows adjustment within $\pm 10\%$. Turning clockwise increases the output voltage.
LED	Operation Indicator (Green)	Lights when the output voltage is on.
+V -V	DC Output Terminals	+V: Positive output terminal -V: Negative output terminal
	Ground Terminal	Grounding the terminal reduces high-frequency currents caused by switching.
AC	Input Terminal	Accepts a wide range of voltage and frequency. Polarity is irrelevant when using a DC input.

Accessories

Mounting Bracket (Optional)

Model	Mounting Plate	L-shaped Bracket (wide)	L-shaped Bracket (narrow)	Dimensions
PS3L-A/B	PS9Z-3E1B	PS9Z-3E2B	PS9Z-3E3B	See page 124
PS3L-C	PS9Z-3E1C	PS9Z-3E2C	PS9Z-3E3C	
PS3L-D	PS9Z-3E1D	PS9Z-3E2D	PS9Z-3E3D	
PS3L-E	PS9Z-3L1F	PS9Z-3E2E	PS9Z-3E3E	
PS3L-F	PS9Z-3L1F	PS9Z-3E2F	PS9Z-3E3F	
PS3L-G	PS9Z-3L1G	—	—	

DIN-Rail Mounting Bracket (Optional)

Model	Part Number
PS3L-A	PS9Z-3E4C
PS3L-B	
PS3L-C	PS9Z-3E4D
PS3L-D	
PS3L-E	PS9Z-3E4F
PS3L-F	

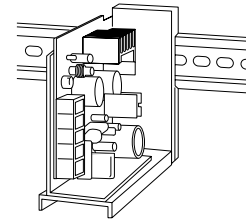

DIN-rail mounting brackets are ordered separately from switching power supplies.

DIN-Rail Mounting Bracket Dimensions

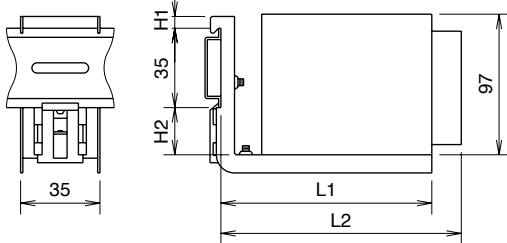

Part Number	Model	L1 (mm)	L2 (mm)	L3 (mm)	H1 (mm)	H2 (mm)
PS9Z-3E4C	PS3L-A	134	117	35	5.2	20.8
	PS3L-B					
PS9Z-3E4D	PS3L-C	186	178.8	39.5	5.2	20.8
	PS3L-D					
PS9Z-3E4F	PS3L-E	216.8	230.8	65	11.2	20
	PS3L-F					

DIN Rail (Optional)

Part Number	Length	Material
BNDN1000	1000 mm	Aluminum

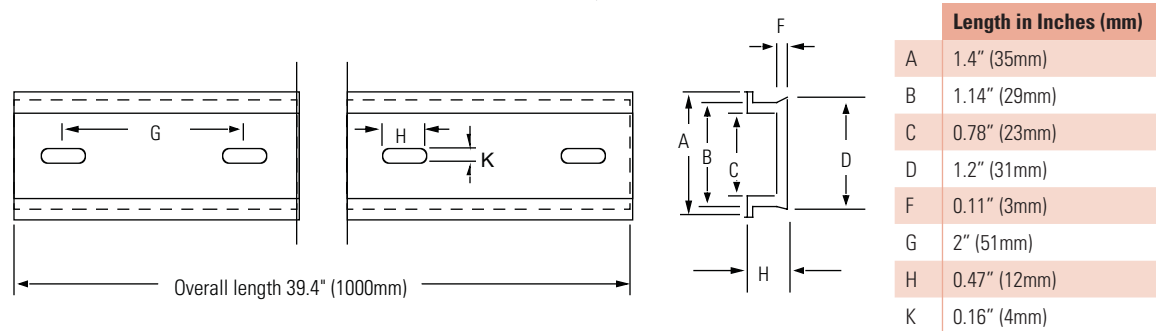

End Clip (Optional)

Item	Package No.
DIN Rail End Clip	BNL5



PLCs

Operator Interfaces

Automation Software

Power Supplies

Sensors

Communication & Networking

Dimensions
(tolerance $\pm 1\text{mm}$)

PS3L-A/B (10/15W)

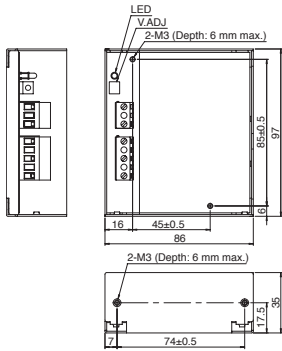

Height 97.0mm
Width 35.0mm
Depth 86.0mm

PS3L-C (30W)

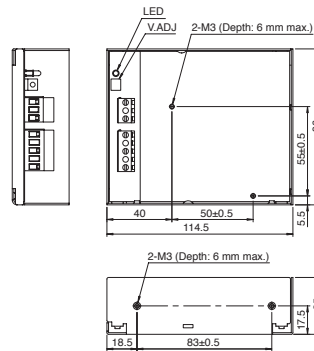

Height 96.0mm
Width 35.0mm
Depth 114.5mm

PS3L-D (50W)

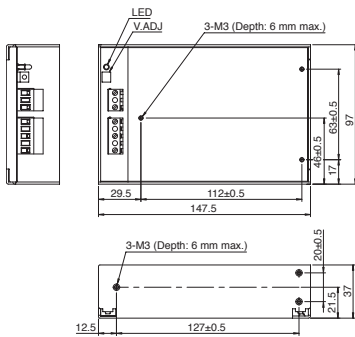

Height 97.0mm
Width 37.0mm
Depth 147.5mm

PS3L-E (100W)

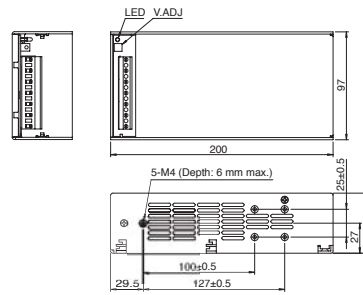

Height 97.0mm
Width 54.0mm
Depth 200.0mm

PS3L-F (150W)

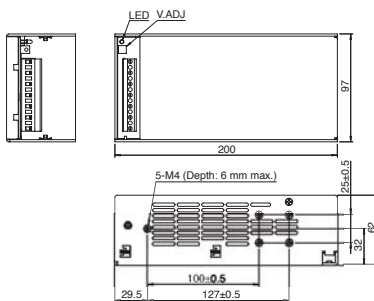

Height 97.0mm
Width 62.0mm
Depth 200.0mm

PS3L-G (300W)

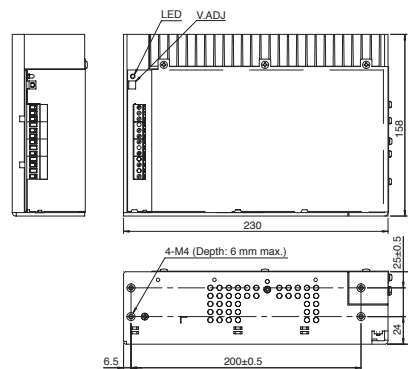

Height 158.0mm
Width 63.0mm
Depth 230.0mm

PLCs

Operator Interfaces

Automation Software

Power Supplies

Sensors

Communication & Networking

Mounting Bracket Dimensions (PS9Z-3E1/PS9Z-3E2/PS9Z-3E3/PS9Z-3L)

Mounting Plate

PS9Z-3E1B/3E1C

(For 10W/15W/30W Types)

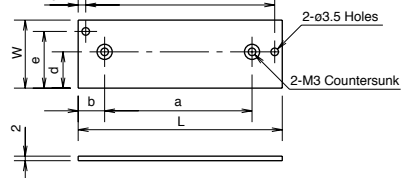

Part Number	Dimensions (mm)							
	W	L	l	a	b	c	d	e
PS9Z-3E1B	35	101	94	74	14.5	3.5	17.5	30
PS9Z-3E1C	33	138.5	128.5	83	32	5	17.5	26

PS9Z-3E1D

(For 50W Type)

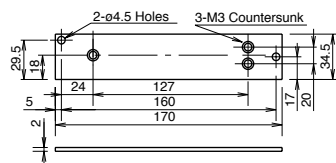

PS9Z-3L1F

(For 100W/150W Types)

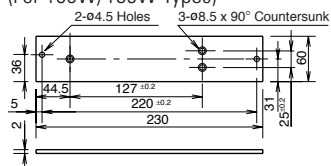

PS9Z-3L1G

(For 300W Type)

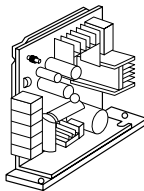
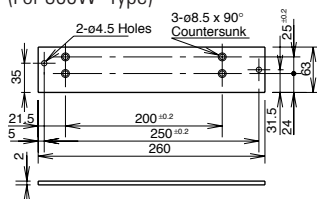

Mounting Hole Layout

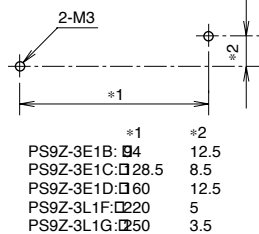

L-shaped Bracket (wide)

PS9Z-3E2B/3E2C

(For 10W/15W/30W Types)

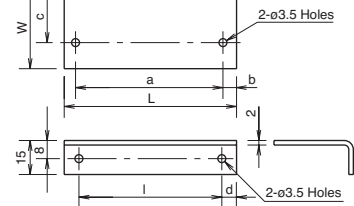

Part Number	Dimensions (mm)						
	W	L	l	a	b	c	d
PS9Z-3E2B	36	95.5	80.5	74	9.5	18.5	7.5
PS9Z-3E2C	38	118.5	104	83	15	20.5	7.5

PS9Z-3E2D

(For 50W Type)

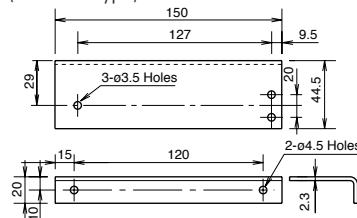

PS9Z-3E2E/3E2F

(For 100W/150W Types)

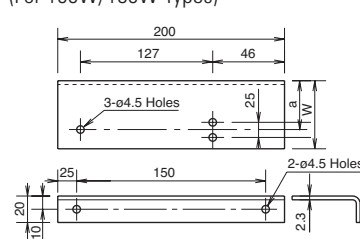

Part Number	Dimensions (mm)	
	W	a
PS9Z-3E2E	59	34.5
PS9Z-3E2F	70	40

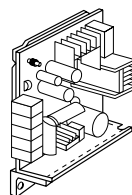

Mounting Hole Layout

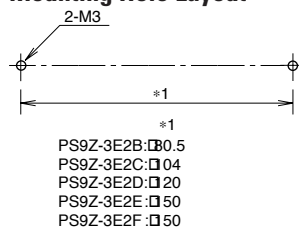

L-shaped Bracket (narrow)

PS9Z-3E3B/3E3C

(For 10W/15W/30W Types)

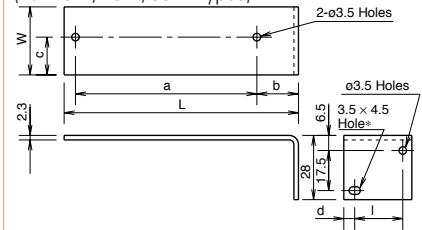

Part Number	Dimensions (mm)						
	W	L	l	a	b	c	d
PS9Z-3E3B	31	103	22.5	74	18	13.5	4.5
PS9Z-3E3C	33	126	25	83	21	15.5	4

PS9Z-3E3D

(For 50W Type)

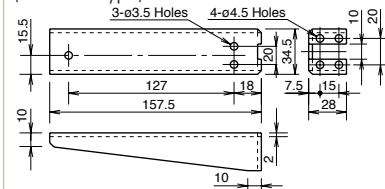

PS9Z-3E3E/3E3F

(For 100W/150W Types)

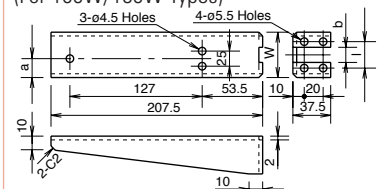

Part Number	Dimensions (mm)			
	W	l	a	b
PS9Z-3E3E	54	32.5	27	12.5
PS9Z-3E3F	65	40	32.5	20

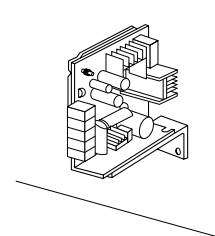

Mounting Hole Layout

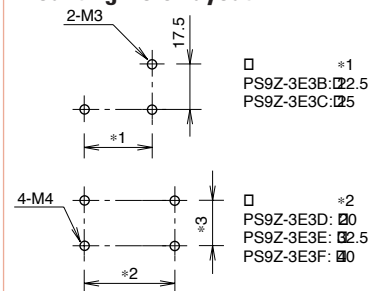

Direct Mount Installation

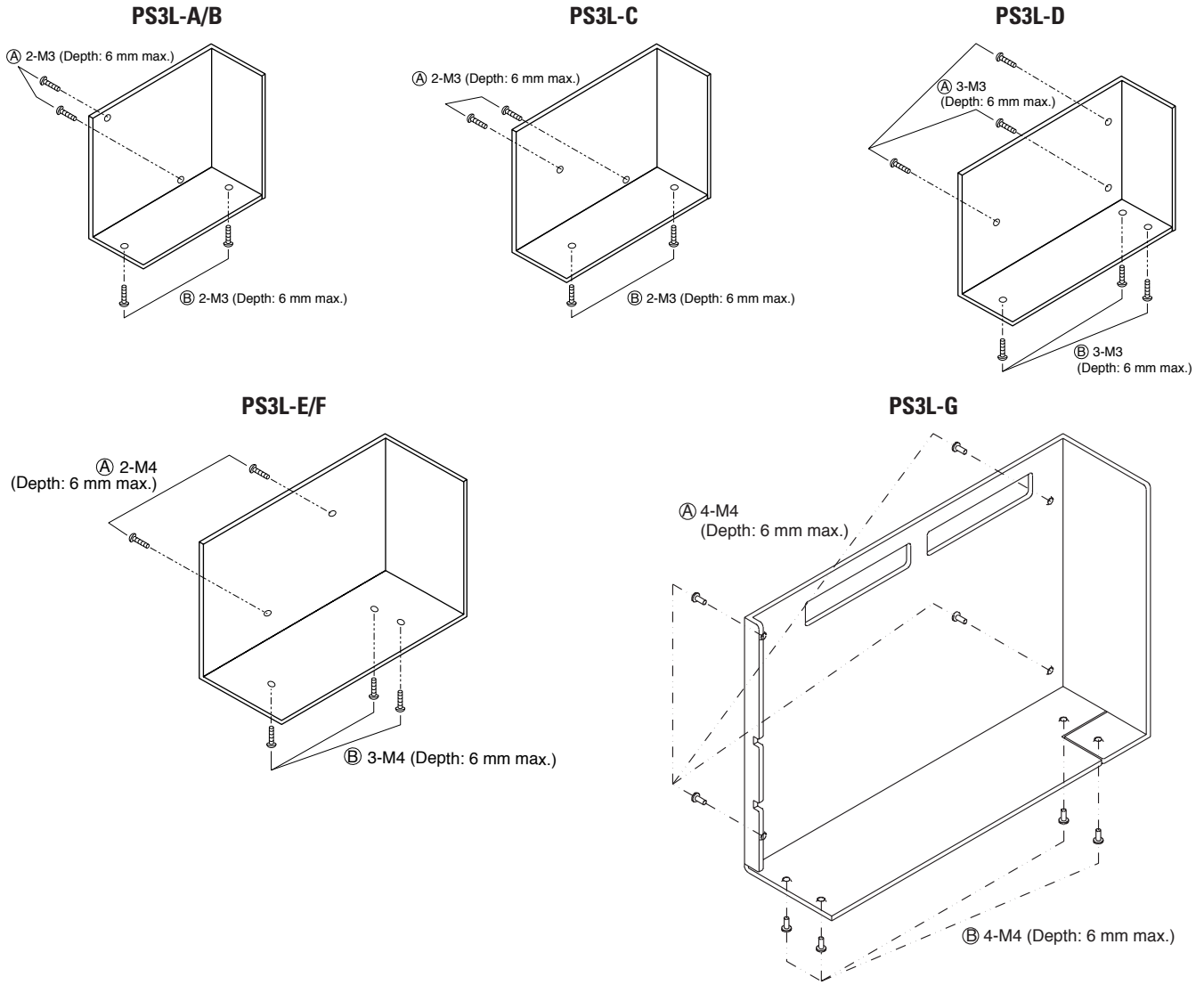

The figures above show the frames only. PC board and parts are omitted for illustration purposes. Mounting screws NOT supplied with power supplies.

Installation	Mounting Hole Layout				
	PS3L-A/B	PS3L-C	PS3L-D	PS3L-E/F	PS3L-G
A Side Mounting (screw from the back)					
B Side Mounting (screw from the back)					

Instructions

Notes for Installation

1. PS3L switching power supplies can be installed in either (A) or (B) directions as shown below. For PS3L-E/F/G types, the operating temperature vs. output current characteristics vary with the mounting direction. See the derating curves 120.

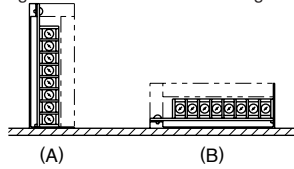

2. Mount the switching power supply on a metallic surface that provides adequate heat dissipation. Be sure to prevent heat build-up around power supplies.

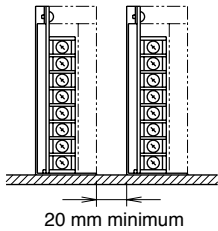

3. Maintain 20 mm clearance between the power supplies.
4. Use mounting screws of a proper length so that screws do not penetrate into the housing of the switching power supply 6 mm or more.
5. Mounting screws cannot be fastened on a PC board. Be sure to fasten the screws on the chassis side.

Adjustment of Output Voltage

The output voltage can be adjusted within $\pm 10\%$ of the rated output voltage by using the V.ADJ control on the front. Turning the V.ADJ clockwise increases the output voltage. When using a higher output voltage, reduce the output current to make sure that the output capacity is within the rating. Note that overvoltage protection may work when increasing the output voltage.

Overcurrent Protection

The output voltage drops automatically when an overcurrent flows due to an overload or short circuit. Normal voltage is automatically restored when the load returns to normal conditions.

Overvoltage Protection (PS3L-A)

The PS3L-A uses a Zener diode for overvoltage protection. Do not apply an external overvoltage to the output terminal.

(PS3L-B/C/D/E/F/G)

The output is turned off by overvoltage protection when an overvoltage is applied. When the output voltage has dropped due to an overvoltage (120% or more), turn the input off, and after one minute, turn the input on again.

Series Operation

The following series operations are allowed.

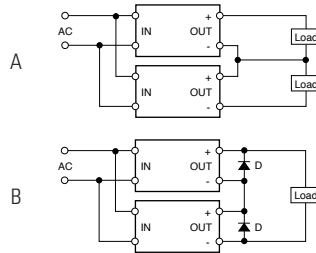

For series operation (B), insert Schottky diodes D as shown in the figure. Select a Schottky diode in consideration of the rated current.

Notes for Operation

1. Output interruption may indicate blown fuses.
2. The internal fuse inside the power supply is for AC input. When using with DC input, install an external fuse for DC input. To avoid blown fuses, select fuses in consideration of the rated current of internal fuses.

Rated Current of Internal Fuses

Part Number	Rated Fuse Current
PS3L-A	2A
PS3L-B	
PS3L-C	3.15A
PS3L-D	2A
PS3L-E	4A
PS3L-F	
PS3L-G	6.3A

3. Avoid overload and short-circuit for a long period of time, otherwise the internal elements may be damaged.

4. Not suitable for parallel operation.

5. DC input operation is not subject to safety standards.

Insulation/Dielectric Test

When conducting an insulation/dielectric test, short-circuit the input (between AC) and output (between + and -). Do not apply or interrupt the voltage suddenly, otherwise the surge voltage may be generated and the power supply may be damaged.

Safety Precautions

- Do not use switching power supplies with electric equipment whose malfunction or inadvertent operation may damage the human body or life directly.
- Make sure that the input voltage and output current do not exceed the ratings. If the input voltage and output current exceed the ratings, electric shock, fire, or malfunction may occur.
- Do not disassemble, repair, or modify the power supplies.
- Do not touch the switching power supplies while input voltage is applied, otherwise electric shock may occur.
- Provide the final product with protection against malfunction or damage that may be caused by the malfunction of switching power supplies.
- Operating temperatures should not exceed the ratings. Be sure to note the derating characteristics. If the operating temperature exceeds the ratings, electric shock, fire, or malfunction may occur.
- Blown fuses indicate that the internal circuits are damaged. Do not just replace the fuse and reoperate, otherwise electric shock, fire, or malfunction may occur.
- **Do not use the switching power supplies to charge rechargeable batteries.**

X-ON Electronics

Largest Supplier of Electrical and Electronic Components

Click to view similar products for [Idec manufacturer](#):

Other Similar products are found below :

[LT7A-XE-G](#) [LT7A-XE-R](#) [LT7B-A250](#) [LT7B-A250FB](#) [LW6L-M1C24MG](#) [FB1T-000Z](#) [FB1W-HW1B-V411R-EMO-2](#) [FB1W-XW1E-BV411MR](#) [FB1W-XW1E-BV413MR](#) [FB3W-413Z](#) [FC2A-KP1C](#) [FC4A-J8AT1](#) [FC4A-T16S3](#) [FC5A-C16R2C](#) [MM-SMART-24](#) [MM-SMART-40](#) [FT1A-C12RA-S](#) [FT1A-C12RA-W](#) [FT1A-C14SA-B](#) [PF3S-BP12](#) [PS3X-D24AFG](#) [PS3X-Q12AFG](#) [GT3A-3AD24](#) [GT3F-2EAD24](#) [GT3S-2AF20](#) [GT3W-A16AD24](#) [GT3W-A33AF20N](#) [ABD302N-R](#) [ABD410N-R](#) [ABFD411N-G](#) [ABN4F11-G](#) [HE2B-M211PB](#) [HE2G-21SH](#) [HE9Z-D3B](#) [HG9Z-2A1](#) [HG9Z-XC300](#) [ACSNO-6123-FB-C6002](#) [RH3V2-UAC240V](#) [DFAN-031-B](#) [AL6M-LK1-G](#) [AL6M-P3-R](#) [AL6Q-M13-W](#) [AL6Q-M23P-QG](#) [ALFD29901DN-G-24V](#) [ALFN22211DNG-U](#) [ALFW224611D-W](#) [ALNE8811-G](#) [ALQW2B24611D-G](#) [ALW212611-G](#) [ALW22211DG](#)