

Force Guided Relay

RF2S/RF2V 2-Pole

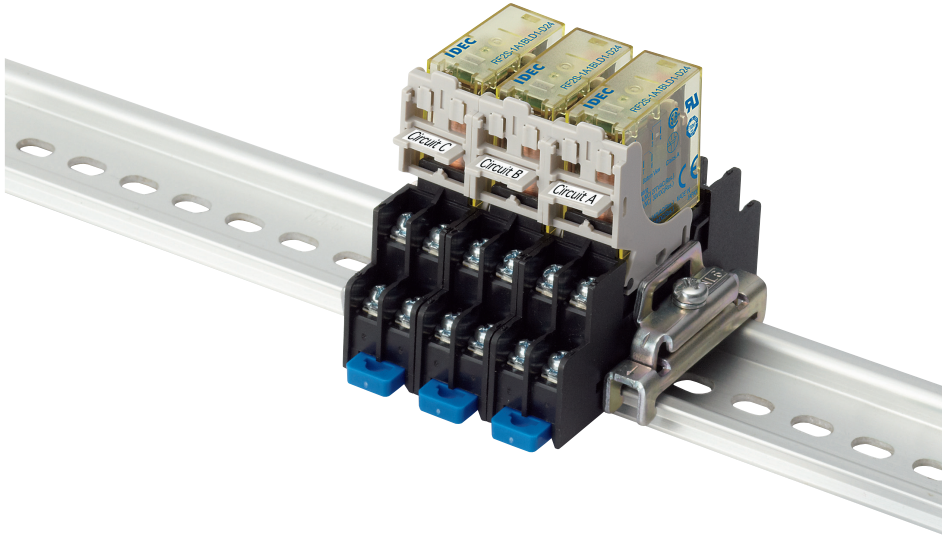

PRODUCT DESCRIPTION

These compact relays provide reliable safety for man and machine in the event of a malfunction, while cutting down on cost and installation space. Both RF2 series relays come standard with a mechanical indicator and are available with LED indicator and or Coil diode. The RF2S Plug-in and RF2V PC board mount force guided relays are ideal for smaller control circuits. The RF2S and RF2V series provide 2 contacts sets. Available in 1 Normally open and 1 Normally closed or Double Pole Double throw versions. The RF2 series mount using the SJ series of finger safe sockets.

SPECIFICATIONS

Contact Configuration	Terminal Style	LED Indicator	W/Diode	Degree of Protection		Rated Coil Voltage	Part No.	
				Flux-tight (RTII)	Sealed (RTII)			
2-pole	SPST-NO+ SPST-NC	Plug-In	With	✓	✓	12V DC	RF2S-1A1BLD1-D12	
			Without	–	✓		24V DC	RF2S-1A1B-D24
				✓	✓			RF2S-1A1BD1-D24
			With	✓	✓		48V DC	RF2S-1A1BLD1-D24
				✓	✓			RF2S-1A1BLD1K-D24
			Without	–	✓		48V DC	RF2S-1A1B-D48
		✓		✓	RF2S-1A1BLD1-D48			
		With	✓	✓	48V DC	RF2S-1A1BLD1K-D48		
			✓	✓		RF2S-1A1BLD1K-D48		
		PC Board	Without	–	✓	12V DC	RF2V-1A1B-D12	
				–	✓		RF2V-1A1B-D24	
				–	✓		24V DC	RF2V-1A1BK-D24
	✓			✓	RF2V-1A1BD1-D24			
	✓			✓	RF2V-1A1BD1K-D24			
With	✓			✓	RF2V-1A1BLD1K-D24			
Without	–	✓	48V DC	RF2V-1A1B-D48				
	–	✓		24V DC	RF2V-2C-D24			
DPDT								

KEY FEATURES

- 2-pole force guided relay to reduce cost and installation space
- Force guided contact mechanism (EN50205 Type A TÜV approved).
- Reinforced insulation between coil and contact and contacts of different poles
- Mechanical indicator shows contact status
- Two terminal styles - socket mounting and PC board mounting
- RTIII degree of protection, LED, diode models available
- Can be used with SJ series relay socket.



*Other part numbers are available. See below (Contact IDEC for details)

PART NUMBER CONFIGURATION

RF	2		S		1A1B		LD1		K	-	D24	
Series	No. of Poles		Terminal Style		Contact Configuration		Option		Degree of Protection		Rated Coil Voltage	
	2	2-Pole	S	Plug-in	1A1B	SPST-NO+ SPST-NC	Blank	Standard	Blank	RTII	D12	12V DC
			V	PC Board			L	With LED indicator	K	RTII	D24	24V DC
						DPDT	D	With diode (Note 1)			D48	48V DC
							D1	With diode of reverse polarity coil (Note 2)				
							LD	With LED indicator & diode (Note 1)				
							LD1	With LED indicator & diode of reverse polarity coil (Note 2)				

Note 1: With diode: terminal 1–, terminal 8+

Note 2: With diode of reverse polarity coil, terminal 1+, terminal 8–

Note 3: Use this chart for interpreting part numbers. Not all possible variations can be realized

RATINGS

Coil Ratings

Rated Voltage (V)	Rated Current (mA) ±15% (at 20°C)		Coil Resistance ±10% (at 20°C)		Operating Characteristics (against rated values at 20°C)			Power Consumption
	Without LED	With LED	Without LED	With LED	Minimum Pickup Voltage	Dropout Voltage	Maximum Continuous Applied Voltage	
12V DC	58	63	205	205	75% maximum	10% minimum	110%	Approx. 0.7W
24V DC	29	33	820	820				
48V DC	14.6	18	3300	3300				

Note: Maximum continuous applied voltage is the maximum voltage that can be applied to relay coils.

STANDARD RATINGS

Voltage	UL Rating Resistive		CSA Rating Resistive	
	NO	NC	NO	NC
277V AC	6A	3A	6A	3A
30V DC	6A	3A	6A	3A

Voltage	TÜV Rating Resistive	
	NO	NC
240VAC	6A	3A
24V DC	6A	3A

SPCIFICATIONS

Model		RF2S (Plug-in Terminal)	RF2V (PC board terminal)
No. of Poles		2-pole	
Contact Configuration		SPST-NO + SPST-NC, DPDT	
Disconnecting Means		Micro disconnection	
Contact Resistance (Note 1)		100mΩ maximum	
Contact Material		AgNi+Au-Clad	
Degree of Protection		RTII (flux-tight), RTIII (sealed)	
Rated Load (resistive load)		NO contact: 240V AC, 6A/24V DC, 6A NC contact: 240V AC, 3A/24V DC, 3A	
Contact	Maximum Allowable Power (resistive load)	NO contact: 1440VA/144W, NC contact: 720VA/72W	
	Maximum Allowable Voltage	250V AC, 125V DC	
	Maximum Allowable Current	6A	
Minimum Applicable Load (Note 2)		1V DC, 1mA	
Power Consumption		Approx. 0.7W	
Rated Insulation Voltage		250V	
Insulation Resistance		1000MΩ minimum (500V megger)	
Impulse Withstand Voltage		6000V	
Pollution Degree		2	
Dielectric Strength	Between contact and coil	5000V AC, 1 minute	
	Between contacts of the same pole	4000V AC, 1 minute	
	Between contacts of the different poles	1500V AC, 1 minute	
Operating Time		15ms max. (at the rated coil voltage, excluding contact bounce time)	
Response Time (Note 3)		5ms max. (at the rated coil voltage, without diode) 20ms max. (at the rated coil voltage, with diode)	
Release Time		10ms max. (at the rated coil voltage, excluding contact bounce time, without diode) 25ms max. (at the rated coil voltage, excluding contact bounce time, with diode)	
Vibration Resistance	Operating Extremes	NO contact: 10 to 55Hz, amplitude 0.75mm NC contact: 10 to 55Hz, amplitude 0.2mm	
	Damage Limits	10 to 55Hz, amplitude 0.75mm	
Shock Resistance	Operating Extremes	NO contact: 100m/s ² , NC contact: 50m/s ²	
	Damage Limits	1000m/s ²	
Electrical Life		NO contact: 100,000 operations minimum (operating frequency 1,800 per hour) at 240V 6A resistive load or 2A inductive load (power factor 0.4) 100,000 operations minimum (operating frequency 1,800 per hour) at 24V 6A resistive load or 1A inductive load (time constant 48ms) NC contact: 100,000 operations minimum (operating frequency 1,800 per hour) at 240V AC, 3A resistive load or 2A inductive load (power factor 0.4) 100,000 operations minimum (operating frequency 1,800 per hour) at 24V DC, 3A resistive load or 1A inductive load (time constant 48ms)	
Mechanical Life		10 million operations minimum (operating frequency 18,000 operations per hour)	
Operating Temperature		Single mounting: -40 to +70°C (no freezing) Collective mounting: -40 to +55°C (no freezing)	-40 to +70°C (no freezing)
Operating Humidity		5 to 85%RH (no condensation)	
Storage Temperature		-40 to +85°C (no freezing)	
Weight (approx.)		18g (without LED/diode), 20g (with LED/with diode/with LED & diode)	



Above values are initial values

Note 1: Measured using 5V DC, 1A voltage drop method.

Note 2: Failure rate level P, reference value

Note 3: Response time is the time until NO contact opens, after the coil voltage is turned off.

SOCKET STANDARDS & CERTIFICATION

Applicable Standards	Mark	Certification Organization/File No.
UL508		UL Recognition File No. E62437
CSA C22.2 No.14		CSA File No. LR84913
EN60999-1 (Note 1) EN60664-1 (Note 2)		EU Low Voltage Directive

Note 1: Fingersafe screw terminal only.

Note 2: PC board terminal only.

Note: Sockets can be used on RF2S (Plug-in terminal) only.

SOCKETS

DIN-rail Socket

Package Quantity: 1

Terminal Style	No. of Poles	Terminal No. Marking Color	Part No.	No. of Poles	Part No.
Standard Screw Terminal	2	White	SJ2S-05BW	2	SJ2S-61
Fingersafe Screw Terminal			SJ2S-07LW		SJ2S-61

• Release lever is supplied with the socket.

PC Board Socket

Package Quantity: 1

SOCKET SPECIFICATIONS

Model		SJ2S-05B/-07L (DIN Rail Socket)	SJ2S-61 (PC Board Socket)
Rated Current		8A	
Rated Insulation Voltage		250V AC/DC	
Applicable Wire		2mm ²	-
Applicable Crimping Terminal		See the dimensions shown at right	-
Recommended Tightening Torque		0.6 to 1.0 N·m	-
Screw Terminal Style		M3 slotted Phillips screw (self-lifting)	-
Terminal Strength		Wire tensile strength: 50N minimum	-
Dielectric Strength (Note)	Between contact and coil	4000V AC, 1 minute	5000V AC, 1 minute
	Between contacts of the same pole	1000V AC, 1 minute	
	Between contacts of the different pole	3000V AC, 1 minute	
Vibration Resistance	Damage limits	90m/s ²	
	Resonance	Frequency 10 to 55Hz, amplitude 0.75mm	
Shock Resistance (damage limits)		1000m/s ²	
Operating Temperature		-40 to +70°C (no freezing)	
Operating Humidity		5 to 85% RH (no condensation)	
Storage Temperature		-55 to +85°C (no freezing)	
Storage Humidity		5 to 85% RH (no condensation)	
Degree of Protection (Screw Terminal)		SJ2S-07L: IP20 (IEC 60529)	-
Weight		34g	4.5g

Note: The above are same when used with a RF2 force guided relay.

ACCESSORIES

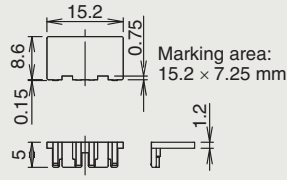
Description/Shape	Material	Part No.	Remarks
Removable Marking Plate 	Plastic (white)	SJ9Z-PW	 Marking area: 15.2 × 7.25 mm
Jumper	For 2 sockets	SJ9Z-JF2	Terminal centers: 15.5mm Rated current: 12A Ensure that the total current to the jumper does not exceed the maximum current.
	For 5 sockets	SJ9Z-JF5	
	For 8 sockets	SJ9Z-JF8	
	For 10 sockets	SJ9Z-JF10	

REPLACEMENT PARTS

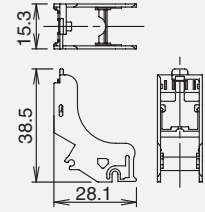
Description/Shape	Material	Part No.	Dimensions (mm)
Release Lever (with integrated marking plate) 	Plastic (gray)	SJ9Z-CM	 When not using marking plate

RELAY DIMENSIONS

RF2S (plug-in terminal)

Standard (without LED/diode)

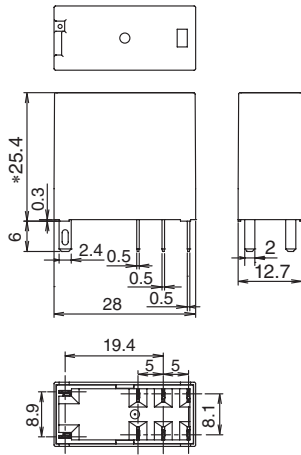

* With LED/diode: 28.4

With LED/diode

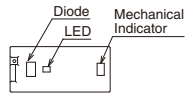

RF2V (PC board terminal)

Standard (without LED/diode)

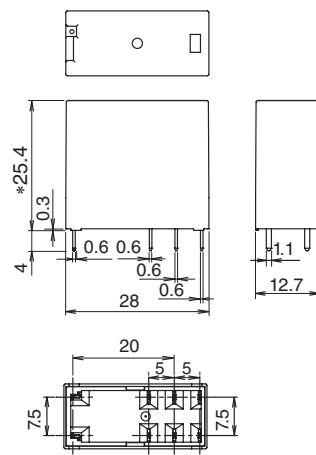

* With LED/diode: 28.4

With LED/diode

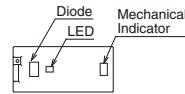

PC Board Terminal Mounting Hole Layout

(Bottom View)

RF2V (SPST-NO + SPST-NC)

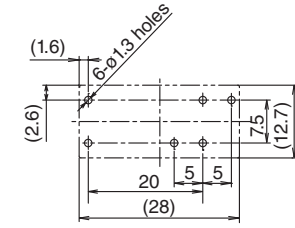

RF2V (DPDT)

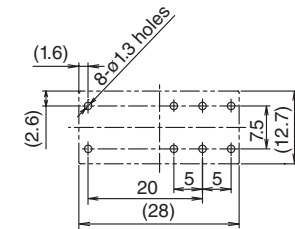

SOCKET DIMENSIONS

SJ2S-07L

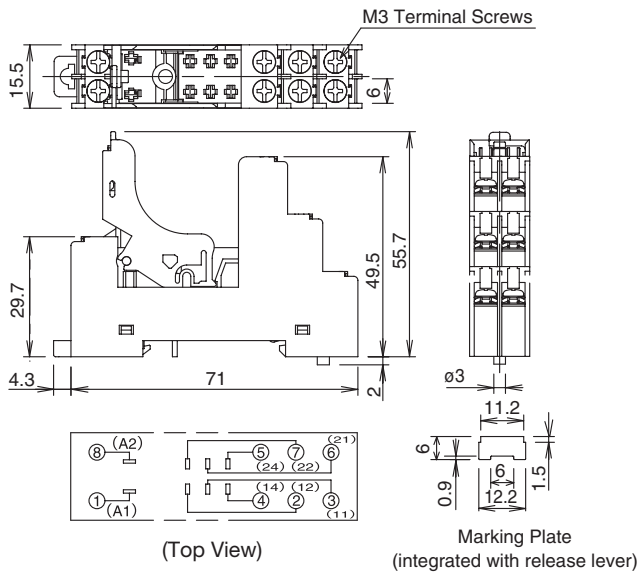

SJ2S-05B

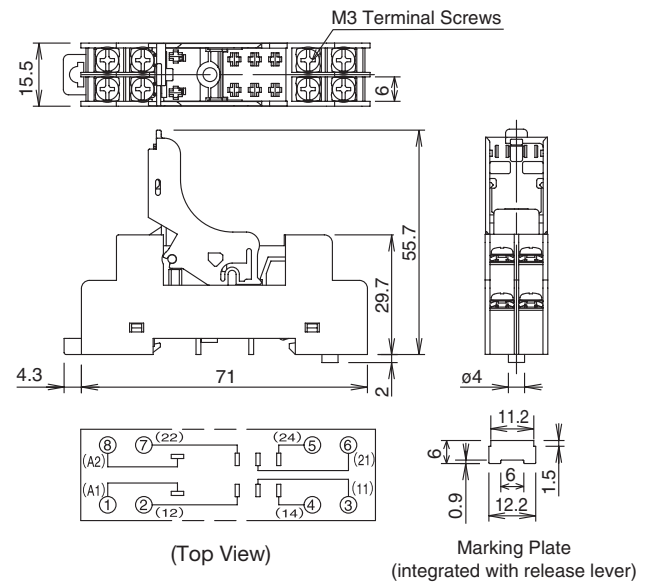

SJ2S-61

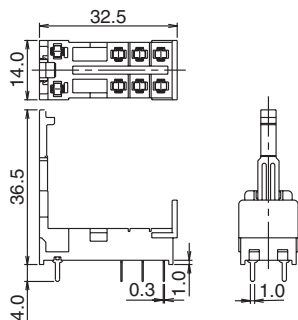

INTERNAL CONNECTION (BOTTOM VIEW)

RF2 -1A1B

Standard

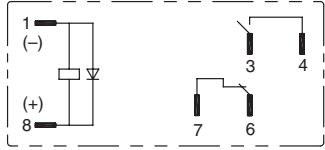

RF2 -1A1BD1-

With LED indicator + diode of reverse polarity coil

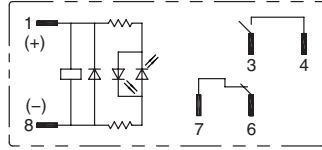

RF2 -1A1BLD

With LED indicator + diode

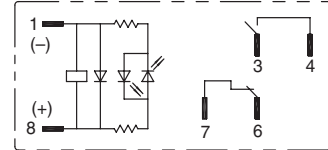

RF2 -2C

Standard

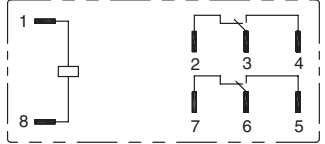

RF2 -2CLD1-

With LED indicator + diode of reverse polarity coil

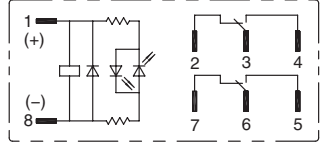

RF2 -2CLDWith

LED indicator + diode

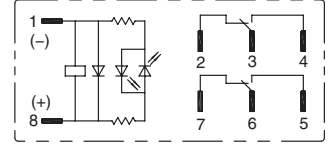

RF2 -1A1BL

With LED indicator

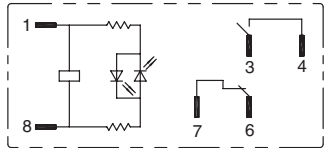

RF2 -1A1BD1-

With diode of reverse polarity coil

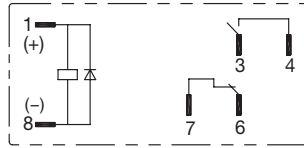

RF2 -1A1BD

With diode

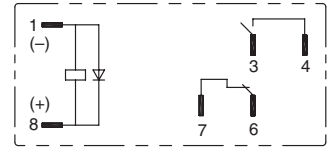

RF2 -2CL

With LED indicator

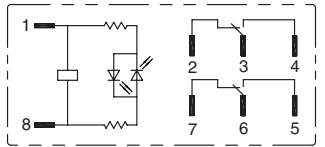

RF2 -2CD1

With diode of reverse polarity coil

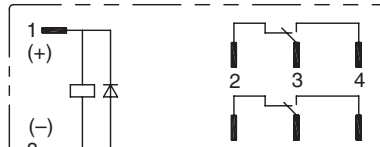

RF2 -2CD

With diode

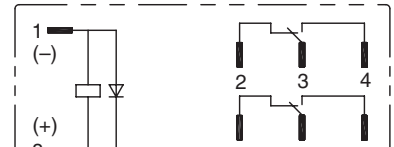

OPERATING INSTRUCTIONS

1. When using DPDT model as a force guided relay

Use in SPST-NO + SPST-NC wiring according to EN50205 (2002)

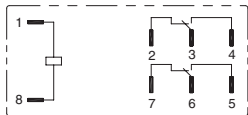

RF2*-2C-o Standard

Example: Use terminal 3-4 as NO contact and 6-7 as NC contact. Or terminal 2-3 as NC contact and terminal 5-6 as NO contact.

2. Driving Circuit for Relays

2-1. To make sure of correct relay operation, apply rated voltage to the relay coil. Pickup and dropout voltages may differ according to operating temperature and conditions.

2-2. Input voltage for DC coil:

A complete DC voltage is best for the coil power to make sure of stable operation. When using a power supply containing a ripple voltage, suppress the ripple factor within 5%. When power is supplied through

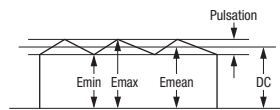
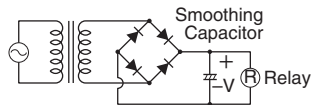

$$\text{Ripple Factor (\%)} = \frac{E_{\max} - E_{\min}}{E_{\text{mean}}} \times 100\%$$

E_{\max} = Maximum of pulsating current
 E_{\min} = Minimum of pulsating current
 E_{mean} = DC operating characteristics, such as pickup

a rectification circuit, the relay operating characteristics, such as pickup

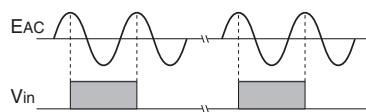
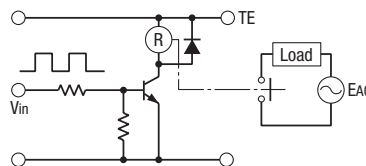

voltage and dropout voltage, depend on the ripple factor. Connect a smoothing capacitor for better operating characteristics as shown below.

2-3. Operating the relay in sync with an AC load:

If the relay operates in sync with AC power voltage of the load, the relay life may be reduced. If this is the case, select a relay in consideration of the required reliability for the load. Or, make the relay turn on and off irrespective of the AC power phase or near the point where the AC phase crosses zero voltage.

2-4. Leakage current while relay is OFF

When driving an element at the same time as the relay operation, special consideration is needed for the circuit design. As shown in the incorrect circuit at right, leakage current (I_o) flows through the relay coil while the relay is off.

Leakage current causes coil release failure or adversely affects the vibration resistance and shock resistance. Design a circuit as shown in the correct example.

Correct

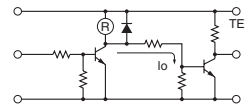

Incorrect

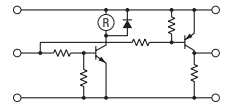

OPERATING INSTRUCTIONS

2-5. Surge suppression for transistor driving circuits:

When the relay coil is turned off, a high-voltage pulse is generated. Be sure to connect a diode to suppress the counter electromotive force. Then, the coil release time becomes slightly longer. To shorten the coil release time, connect a Zener diode between the collector and emitter of the controlling transistor. Select a Zener diode with a Zener voltage slightly higher than the power voltage.

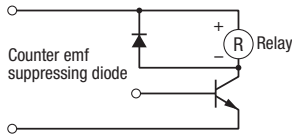

2-6. The coil terminal of the relay has polarity. Connect terminals according to the internal connection diagram. Incorrect wiring may cause malfunction.

3. Protection for Relay Contacts

3-1. The contact ratings show maximum values. Make sure that these values are not exceeded. When an inrush current flows through the load, the contact may become welded. If this is the case, connect a contact protection circuit, such as a current limiting resistor.

3-2. Contact protection circuit:

When switching an inductive load, arcing causes carbides to form on the contacts, resulting in an increased contact resistance. In consideration of contact reliability, contact life, and noise suppression, use of a surge absorbing circuit is recommended. Note that the release time of the load becomes slightly longer. Check the operation using an actual load. Incorrect use of a contact protection circuit will adversely affect switching characteristics. Four typical examples of contact protection circuits are shown in the following table

3-3. Do not use a contact protection circuit as shown below:

RC	<p>This protection circuit can be used for both AC and DC load power circuits. R: Resistor of approximately the same resistance value as the load. C: 0.1 to 1 μF</p>
Diode	<p>This protection circuit can be used for DC load power circuits. Use a diode with the following ratings. Reverse withstand voltage: Power voltage of the load circuit \times 10 Forward current: More than the load current</p>
Varistor	<p>This protection circuit can be used for both AC and DC load power circuits. For the best result, when using on a power voltage of 24 to 48V AC/DC, connect a varistor across the load. When using on a power voltage of 100 to 240V AC/DC, connect a varistor across the contacts.</p>

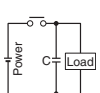

This protection circuit is very effective in arc suppression when opening the contacts. But, when the contacts are closed, a current flows to charge the capacitor, causing contact welding.

Generally, switching a DC inductive load is more difficult than switching a DC resistive load. Using an appropriate arc suppressor will improve the switching characteristics of a DC inductive load.

4. Usage, transport, and storage conditions

4-1. Condensation

Condensation occurs when there is a sudden change in temperature under high temperature and high humidity conditions. The relay insulation may deteriorate due to condensation.

4-2. Freezing

Condensation or other moisture may freeze on the relay when the temperature is lower than 0°C. This causes problems such as sticking of movable parts or delay in operation.

4-3. Low temperature, low humidity environments.

Plastic parts may become brittle when used in low temperature and low humidity environments.

5. Other Notices

5-1. General notice:

1-To maintain the initial characteristics, do not drop or shock the relay.

2-The relay cover cannot be removed from the base during normal operation. To maintain the initial characteristics, do not remove the relay cover.

3-Use the relay in environments free from condensation, dust, sulfur dioxide (SO₂), and hydrogen sulfide (H₂S).

4-RTII model cannot be washed as it is not a sealed type. Also make sure that flux does not leak to the PC board and enter the relay.

5-Make sure that the voltage applied to the coil continuously does not exceed the maximum allowable voltage.

5-2. Connecting outputs to electronic circuits: When the output is connected to a load which responds very quickly, such as an electronic circuit, contact bouncing causes incorrect operation of the load. Take the following measures into consideration.

1-Connect an integration circuit.

2-Suppress the pulse voltage due to bouncing within the noise margin of the load.

5-3. Do not use relays in the vicinity of strong magnetic fields, as this may affect relay operation.

5-4. UL and CSA ratings may differ from product rated values determined by IDEC.

5-5. Others

• Shock Resistance

For the best shock resistance, it is ideal to install the RF2 relay so that the armature movement is perpendicular to the direction of vibration/shock.

• Life

Large loads that causes arcs may result in the contact material scattered off, accumulating around the contact. This will degrade insulation resistance between the circuits. Make sure that the relay is mounted in the correct direction.

• Counter-electromotive force model (diode) Counter-electromotive force diode model has polarity. The diode absorbs counter-electromotive force of relay coil. When excessive external surge voltage is anticipated, take additional counter-electromotive force measures. Otherwise the diode may be damaged.

• When using general purpose relays and force guided relays closely, use of a marking plate (optional) on the release lever or socket is recommended, so that force guided relay can be recognized easily.

6. Notes on PC Board Mounting

• When mounting two or more relays on a PC board, keep a minimum spacing of 5 mm in each direction. If used without spacing of 10 mm, rated current and operating temperature differs. Consult IDEC.

• Manual soldering: Solder the terminals at 350°C within 3 sec.

• Auto-soldering: Preliminary heating at 120°C within 60 sec. Solder at 250°C within 4 to 5 sec.

• Because the terminal part is filled with epoxy resin, do not excessively solder or bend the terminal. Otherwise, air tightness will degrade.

• Avoid the soldering iron from touching the relay cover or the epoxy filled terminal part. Use a non-corrosive resin flux.

• Do not install the relay on the PC board in the way the PC board is bent, otherwise copper foil may be cut or solder may be displaced after operating for a long time or due to vibration, degrading the relay's performance.

• When multiple PC boards with relays are mounted to a rack, the temperature may rise excessively. When mounting relays, leave enough space so that heat will not build up, and so that the relays' ambient temperature remains within the specified operating temperature range.



X-ON Electronics

Largest Supplier of Electrical and Electronic Components

Click to view similar products for [High Frequency / RF Relays](#) category:

Click to view products by [Idec](#) manufacturer:

Other Similar products are found below :

[MW6-12A](#) [ER136CZM9-5B](#) [J114DM4-26M/Q](#) [JMSCD-12XP](#) [ARA200A4HM01](#) [3SBH1020A2](#) [IM07CGR](#) [D3210](#) [ARE13A4HZB01](#)
[ER116C-26A](#) [31 T10](#) [26-200ZA](#) [36 AT5](#) [20-200ZA](#) [36 T5](#) [19-200ZA](#) [36 T5](#) [24-200ZA](#) [27 T5](#) [26-200ZA](#) [27 T5](#) [44-000ZA](#)
[R591362640](#) [R595363125](#) [R574802625](#) [ARS15Y03](#) [R595867120](#) [HF3 02](#) [R574383400](#) [R574493685](#) [R595863115](#) [R577832100](#)
[R594473627](#) [732TN-26](#) [ARS34Y4H](#) [JMGAP-26M](#) [JMSCDD-18XP](#) [1462051-5](#) [1462050-1](#) [1462050-2](#) [ER432DM4-26BSQ](#) [G6K-2F-RF-S-](#)
[DC5](#) [ARE10A4H](#) [ARE1024](#) [ARE1012](#) [ARS1012](#) [ARS1024](#) [ARS14Y4H](#) [ARJ22A12](#) [ARS104H](#) [ER136CM9-26A/Q](#) [G6K-2F-RF-DC3](#) [712-](#)
[5](#) [1-1462039-7](#) [G6K-2F-RF-S-DC3](#) [G6K-2F-RF-S-DC4.5](#)