

**PCB Relay Dimensions (mm)**

RJ1V-C-\*  
SPDT

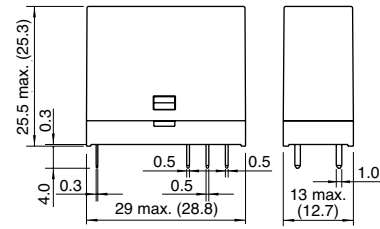

**PCB Mounting Hole Layout (Bottom View)**

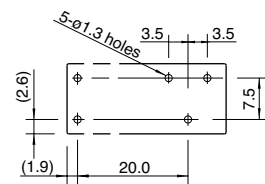

**PCB Internal Circuit Diagrams (Bottom View)**

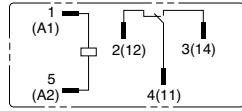

RJ1V-A-\*  
SPST-NO

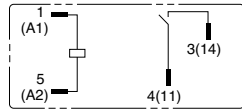
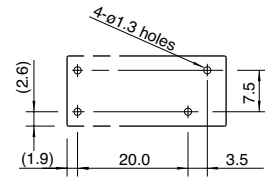
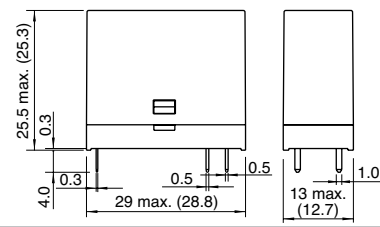

RJ1V-CH-\*  
SPDT  
High Capacity

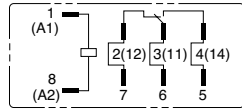
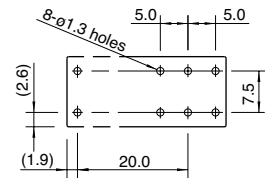
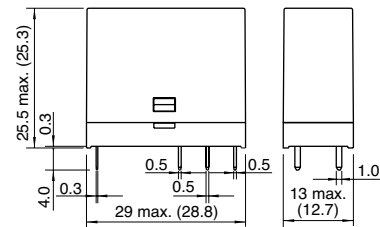

RJ1V-AH-\*  
SPST-NO  
High Capacity

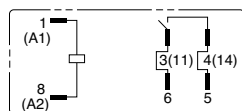
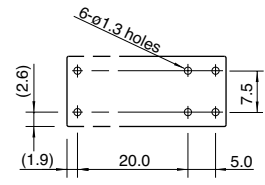
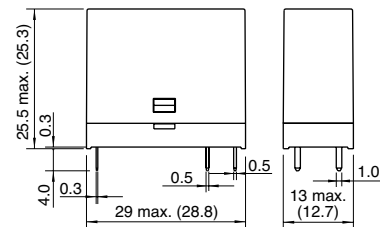

RJ2V-C-\*  
DPDT

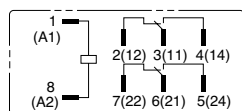
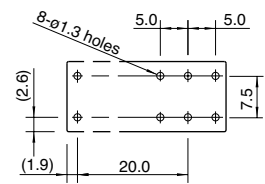

RJ1V-A-\*  
DPST-NO

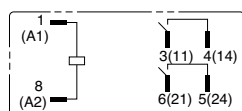
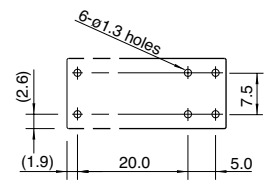
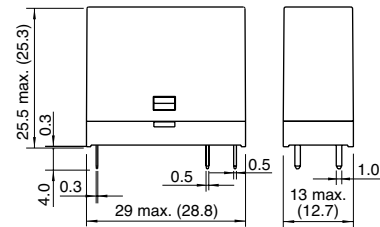

For more information on the these and other IDEC relays, visit: [www.idec.com/relay](http://www.idec.com/relay)

**RJ Series Relays**

**Features**

- Compact size:  
Blade: 12.7 x 27 x 28.8 mm  
PCB: 12.7 x 25.5 x 28.8 mm
- Contact rating:  
Blade: 8A (DPDT), 12A (SPDT)  
PCB: 8A (DPDT & DPST-NO), 12A (SPDT & SPST-NO), 16A (SPDT & SPST-NO)
- Operational life:  
200K cycles at full resistive AC load;  
50 million cycles, no load
- Blade model has optional green, non-polarized LED
- RoHS compliant



**Specifications**

	Blade Models		PCB Models		
	RJ1S	RJ2S	RJ1V	RJ1V (High Capacity)	RJ2V
No. of poles	1	2	1	1	2
Contact Configuration	SPDT	DPDT	SPDT, SPST-NO		DPDT, DPST-NO
Contact Rating	12A	8A	12A	16A	8A
Contact Material	AgNi		AgNi	AgSnIn	AgNi
Enclosure Ratings	-		Flux protection		
Contact Resistance	50 milliohms max		50 milliohms max <sup>Note 1</sup>		
Operating Time	15ms max		15ms max <sup>Note 2</sup>		
Release Time	10ms max		10ms max <sup>Note 2</sup>		
Dielectric Strength	Between contact & coil		5,000V AC, 1 minute		
	Between contacts of same poles		1,000V AC, 1 minute		
	Between contacts of different poles		-	3,000V AC, 1 min.	
Vibration Resistance	Damage limits		10-55Hz, amplitude 0.75mm		
	Operating extremes		10-55Hz, amplitude 0.75mm		
Shock Resistance	Damage limits		100m/s <sup>2</sup> min (10G)		
	Operating extremes		1,000m/s <sup>2</sup> min (100G)		
Mechanical Life	AC		30,000,000 operations		
	DC		50,000,000 operations		
Electrical Life @ Full Rated Load	AC		200,000 operations		
	DC		100,000 operations		
Operating Temperature	-40 to 70° C		-40 to 70° C <sup>Note 3</sup>		
Operating Humidity	5 to 85% RH		5 to 85% RH		
Dimensions (H x W x D mm)	12.7 x 27 x 28.8		12.7 x 25.5 x 28.8		
Weight (Approx.)	19g		SPDT: 17g, SPST-NO: 16g		DPDT: 17g, DPST-NO: 16g



Notes:  
1. Measured using 5V DC, 1A voltage drop method.  
2. Measured at the rated voltage (at 20°C), excluding contact bounce time.  
3. 100% rated voltage.

**Ordering Information**

**Blade Models**

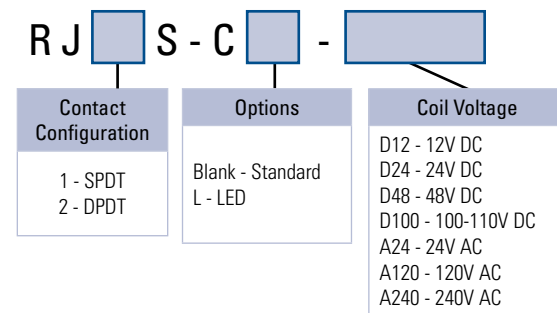

**PCB Models**

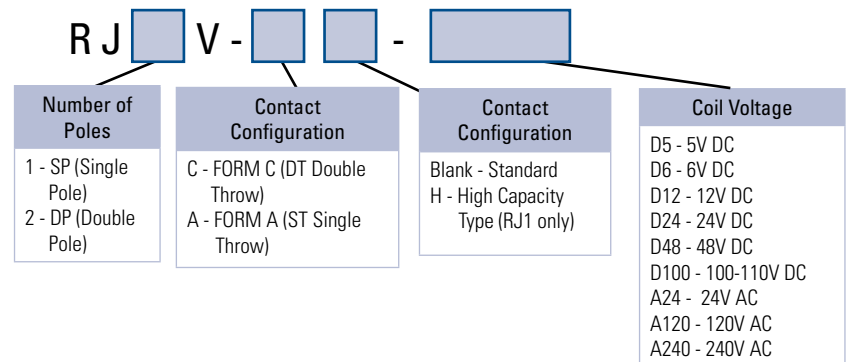



**Contact Ratings**

	Type	Contact	Allowable Contact Power		Rated Load			Allowable Switching Current	Allowable Switching Voltage	Minimum Applicable Load	
			Resistive Load	Inductive Load	Voltage	Resistive Load	Inductive Load cos_ =0.3 L/R=7ms				
Blade Models	1 pole	NO	AC3000V	AC1875VA	250V AC	12A	7.5A	6A	AC250V	DC5V	
		NC	AC3000V	AC1875VA	250V AC	12A	7.5A	6A/3A	DC30V	100mA	
	2 poles	NO	AC2000V	AC1000VA	250V AC	8A	4A	4A	AC250V	DC5V	
		NC	AC2000V	AC1000VA	250V AC	8A	4A	4A/2A	DC30V	100mA	
PCB Models	1 pole	Standard Type	NO	AC3000V	AC1875VA	AC250V	12A	7.5A	12A	AC250V	DC5V
			NC	AC3000V	AC1875VA	AC250V	12A	7.5A			
			NO	DC360W	DC180W	DC30V	12A	6A			
		High Capacity Type	NO	AC4000V	AC2000VA	AC250V	16A	8A	16A	AC250V	DC5V
			NC	AC4000V	AC2000VA	AC250V	16A	8A			
			NO	DC480W	DC240W	DC30V	16A	8A			
	2 poles	NO	NO	AC2000V	AC1000VA	AC250V	8A	4A	8A	AC250V	DC5V
			NC	AC2000V	AC1000VA	AC250V	8A	4A			
			NO	DC240W	DC120W	DC30V	8A	4A			
		NC	NO	AC2000V	AC1000VA	AC250V	8A	4A	8A	AC250V	DC125V
			NC	AC2000V	AC1000VA	AC250V	8A	4A			
			NO	DC120W	DC60W	DC30V	4A	2A			

**Coil Ratings**

	Rated Voltage	Coil Voltage Code	Rated Current (mA) ±15% (at 20°C)				Coil Resistance (ohms)±10% (at 20°C)	Operating Characteristics <sup>2</sup>			Power Consumption		
			Without LED <sup>1</sup>		With LED <sup>1</sup>			Minimum Pickup Voltage	Dropout Voltage	Maximum Allowable Voltage <sup>3</sup>			
			50Hz	60Hz	50Hz	60Hz							
AC	Blade & PCB Models	24V	A24	43.9	37.5	47.5	41.1	243	80% max	30% min	140%	0.9VA (60Hz)	
		120V	A120	8.8	7.5	8.7	7.4	6,400					
		240V	A240	4.3	3.7	4.3	3.7	25,570					
DC	Blade Models	12V	D12	44.2	48.0	271	70% max	10% min	170%	70% max	10% min	170%	0.53W
		24V	D24	22.1	25.7	1,080							
		48V	D48	11.0	10.7	4,340							
	PCB Models	100-110V	D100	5.3 - 5.8	5.2 - 5.7	18,870	70% max	10% min	170%	70% max	10% min	170%	0.53-0.64W
		5V	D5	106	-	47.2							
		6V	D6	88.3	-	67.9							
		12V	D12	44.2	-	271							
		24V	D24	22.1	-	1,080							
		48V	D48	11.0	-	4,340							
		100-110V	D100	5.3 - 5.8	-	18,870							

Notes:  
 1. LED Indicator is only available on Blade relays.  
 2. Operating characteristics are against rated values at 20°C.  
 3. The maximum allowable voltage is the maximum value which can be applied to the relay coils.

**Accessories**

**Socket Part Numbers**

Relay Type	Socket Type	Socket Part Number
Blade Models	DIN Rail Standard	SJ1S-05B
	DIN Rail Fingersafe	SJ1S-07L
	PCB Mount	SJ1S-61
	DIN Rail Standard	SJ2S-05B
RJ1S-□H (HC), RJ2S	DIN Rail Fingersafe	SJ2S-07L
	PCB Mount	SJ2S-61
PCB Models	DIN Rail Fingersafe	SQ1V-07B*
	PCB Mount	SQ1V-63
	DIN Rail Fingersafe	SQ2V-07B*
	PCB Mount	SQ2V-63

**Socket Specifications**

	SJ1S	SJ2S
Rated Insulation Voltage	250V AC/DC	
Applicable Wire	Max up to 2 - #14 AWG	
Applicable Crimping Terminal	2mm <sup>2</sup> x 2	
Screw Size	M3 Slotted-Phillips screw	
Weight	30g	34g



\*Hold-down clip or spring must be removed to use with RJ relays.

**Socket Dimensions - for Blade Relays (mm)**

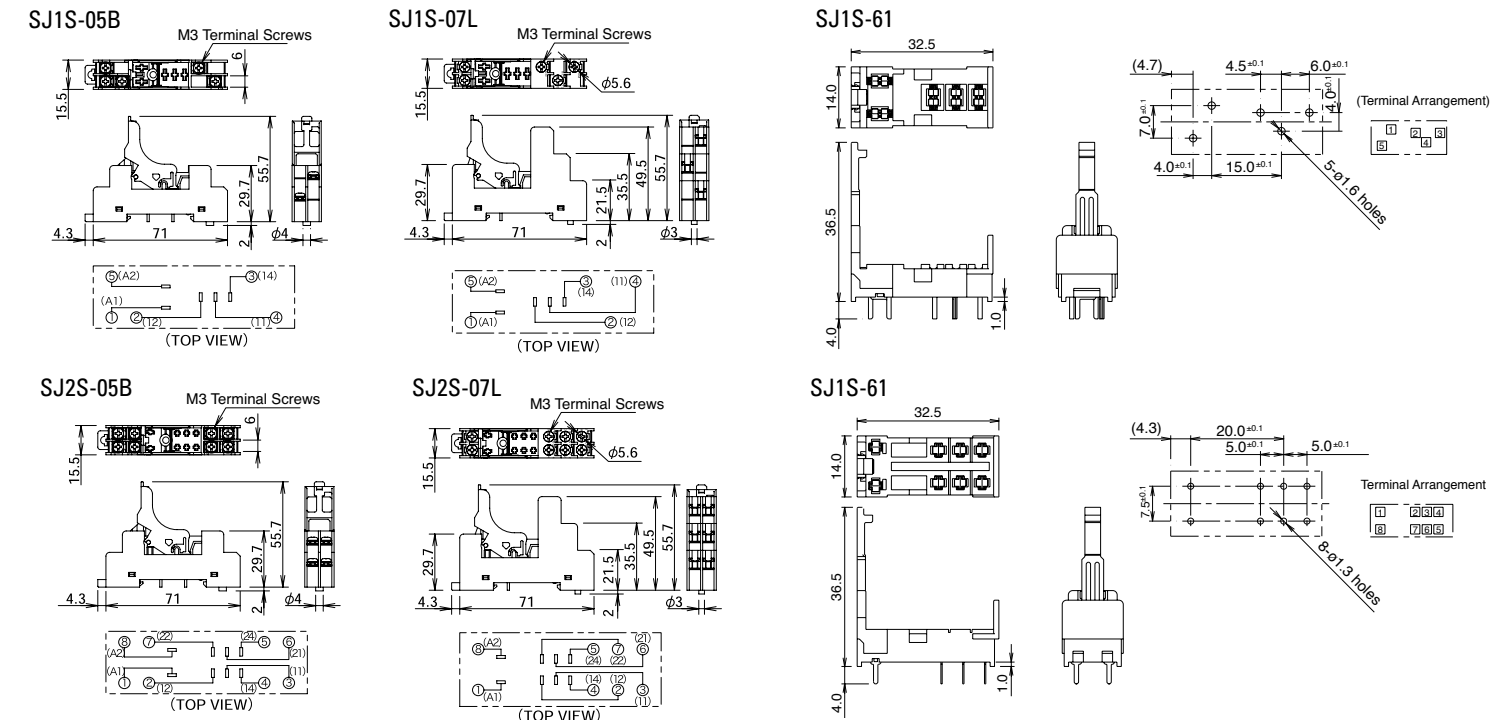

**Blade Relay Dimensions (mm)**

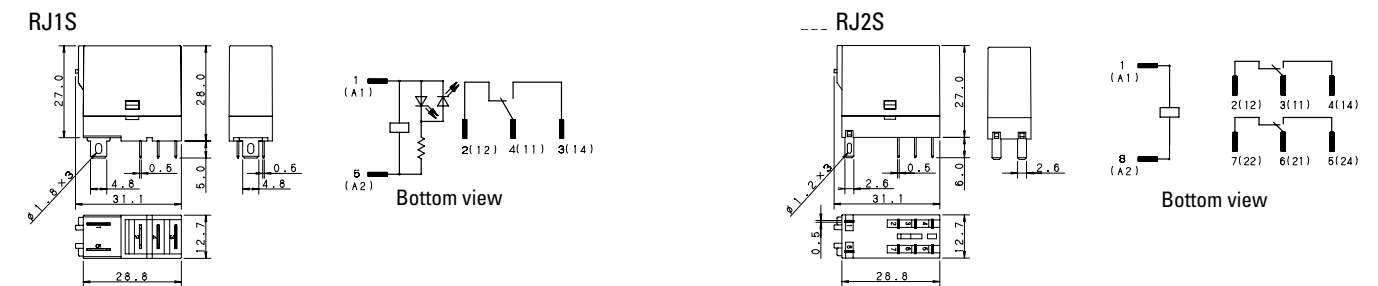

**SQ Socket Dimensions - for PCB Relays (mm)**

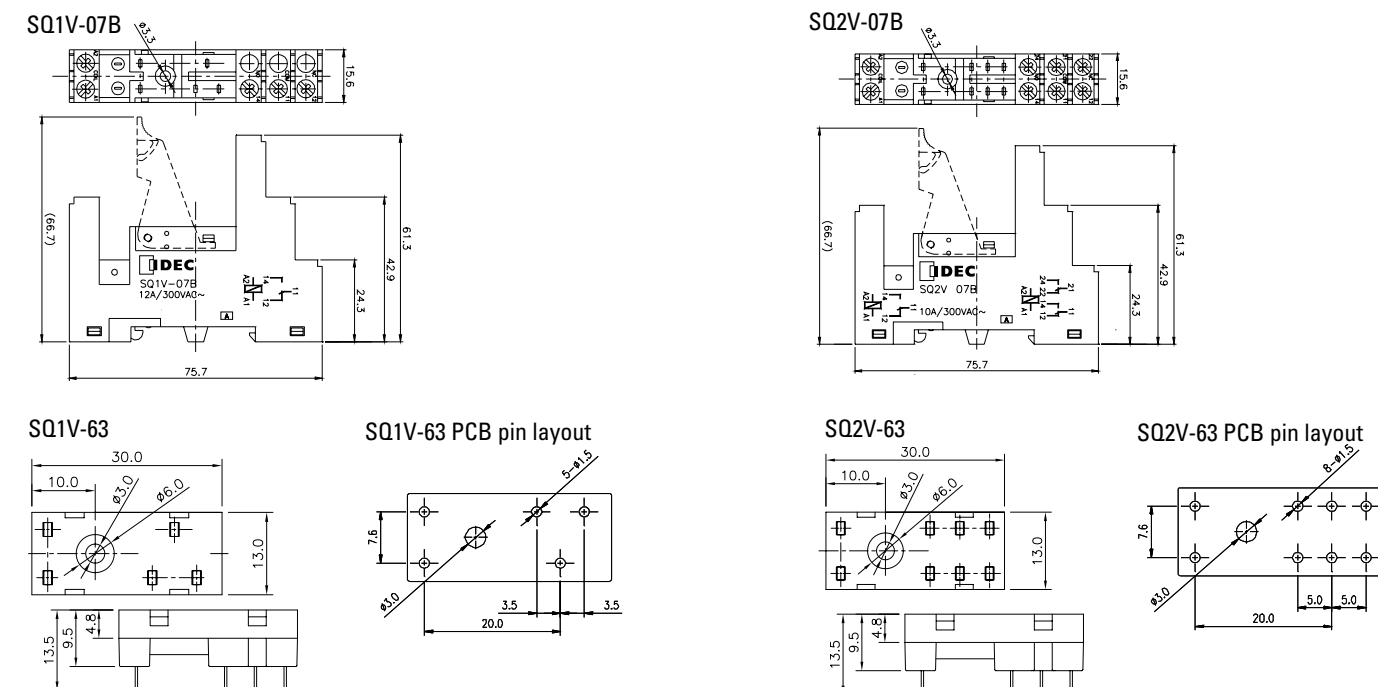

**PCB Relay Dimensions (mm)**

RJ1V-C-\*  
SPDT

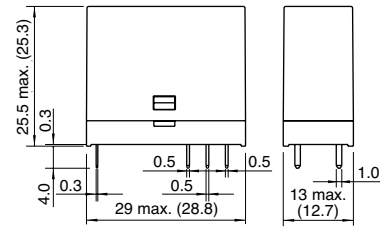

**PCB Mounting Hole Layout (Bottom View)**

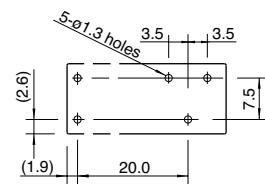

**PCB Internal Circuit Diagrams (Bottom View)**

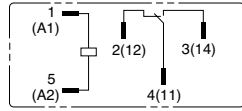

RJ1V-A-\*  
SPST-NO

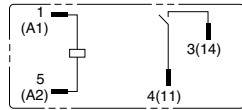
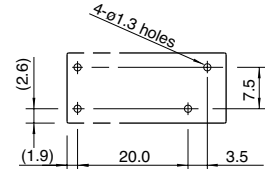
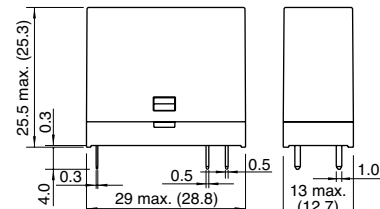

RJ1V-CH-\*  
SPDT  
High Capacity

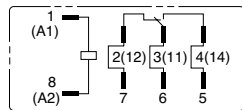
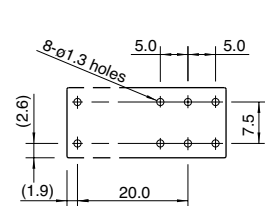
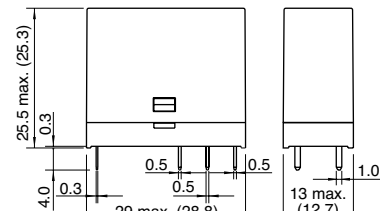

RJ1V-AH-\*  
SPST-NO  
High Capacity

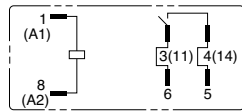
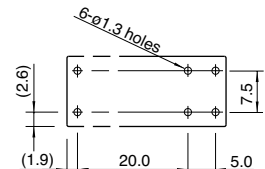
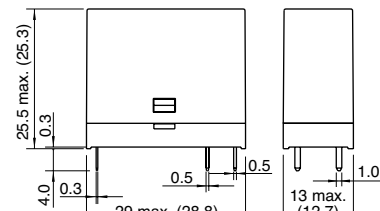

RJ2V-C-\*  
DPDT

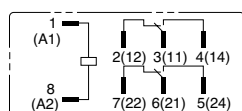
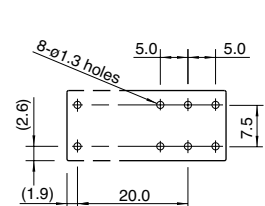
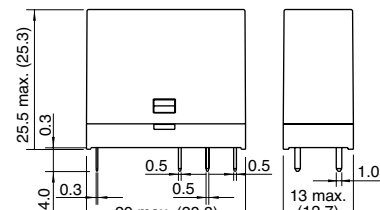

RJ1V-A-\*  
DPST-NO

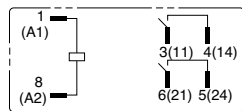
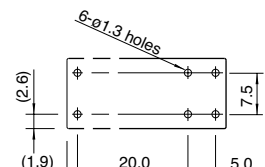
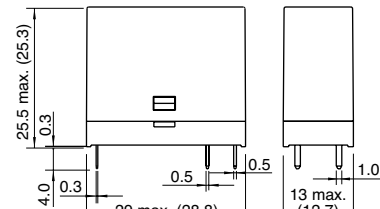

For more information on the these and other IDEC relays, visit: [www.idec.com/relay](http://www.idec.com/relay)

**RJ Series Relays**

**Features**

- Compact size:  
Blade: 12.7 x 27 x 28.8 mm  
PCB: 12.7 x 25.5 x 28.8 mm
- Contact rating:  
Blade: 8A (DPDT), 12A (SPDT)  
PCB: 8A (DPDT & DPST-NO), 12A (SPDT & SPST-NO), 16A (SPDT & SPST-NO)
- Operational life:  
200K cycles at full resistive AC load;  
50 million cycles, no load
- Blade model has optional green, non-polarized LED
- RoHS compliant



**Specifications**

	Blade Models		PCB Models		
	RJ1S	RJ2S	RJ1V	RJ1V (High Capacity)	RJ2V
No. of poles	1	2	1	1	2
Contact Configuration	SPDT	DPDT	SPDT, SPST-NO		DPDT, DPST-NO
Contact Rating	12A	8A	12A	16A	8A
Contact Material	AgNi		AgNi	AgSnIn	AgNi
Enclosure Ratings	-		Flux protection		
Contact Resistance	50 milliohms max		50 milliohms max <sup>Note 1</sup>		
Operating Time	15ms max		15ms max <sup>Note 2</sup>		
Release Time	10ms max		10ms max <sup>Note 2</sup>		
Dielectric Strength	Between contact & coil		5,000V AC, 1 minute		
	Between contacts of same poles		1,000V AC, 1 minute		
	Between contacts of different poles		-	3,000V AC, 1 min.	
Vibration Resistance	Damage limits		10-55Hz, amplitude 0.75mm		
	Operating extremes		10-55Hz, amplitude 0.75mm		
Shock Resistance	Damage limits		100m/s <sup>2</sup> min (10G)		
	Operating extremes		1,000m/s <sup>2</sup> min (100G)		
Mechanical Life	AC		30,000,000 operations		
	DC		50,000,000 operations		
Electrical Life @ Full Rated Load	AC		200,000 operations		
	DC		100,000 operations		
Operating Temperature	-40 to 70° C		-40 to 70° C <sup>Note 3</sup>		
Operating Humidity	5 to 85% RH		5 to 85% RH		
Dimensions (H x W x D mm)	12.7 x 27 x 28.8		12.7 x 25.5 x 28.8		
Weight (Approx.)	19g		SPDT: 17g, SPST-NO: 16g		DPDT: 17g, DPST-NO: 16g



Notes:  
1. Measured using 5V DC, 1A voltage drop method.  
2. Measured at the rated voltage (at 20°C), excluding contact bounce time.  
3. 100% rated voltage.

**Ordering Information**

**Blade Models**

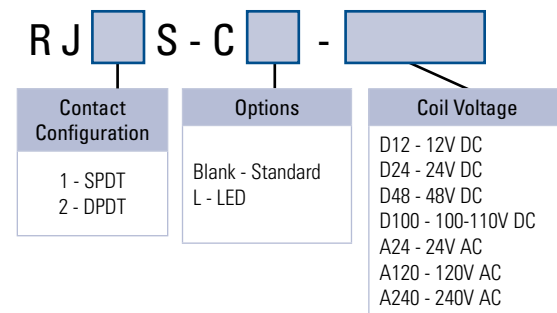

**PCB Models**

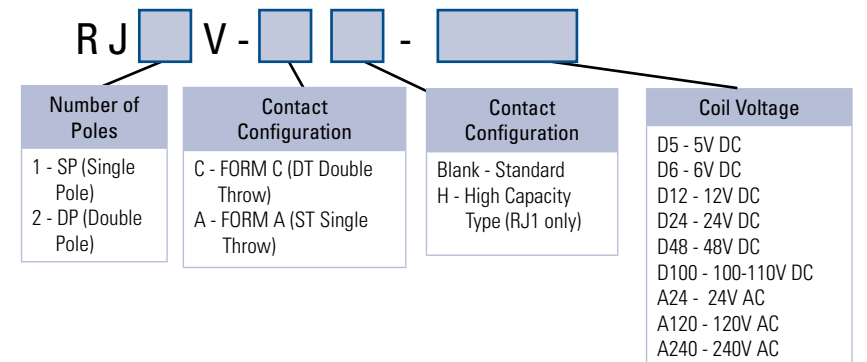

## X-ON Electronics

Largest Supplier of Electrical and Electronic Components

*Click to view similar products for [General Purpose Relays](#) category:*

*Click to view products by [Idec](#) manufacturer:*

Other Similar products are found below :

[APF30318](#) [JVN1AF-4.5V-F](#) [PCN-105D3MHZ](#) [5JO-10000S-SIL](#) [5JO-1000CD-SIL](#) [5JO-400CD-SIL](#) [LY2S-AC220/240](#) [LYQ20DC12](#)  
[6031007G](#) [6131406HQ](#) [6-1393099-3](#) [6-1393099-8](#) [6-1393122-4](#) [6-1393123-2](#) [6-1393767-1](#) [6-1393843-7](#) [6-1415012-1](#) [6-1419102-2](#) [6-](#)  
[1423698-4](#) [6-1608051-6](#) [6-1608067-0](#) [6-1616170-6](#) [6-1616248-2](#) [6-1616282-3](#) [6-1616348-2](#) [6-1616350-1](#) [6-1616350-8](#) [6-1616358-7](#) [6-](#)  
[1616359-9](#) [6-1616360-9](#) [6-1616931-6](#) [6-1617039-1](#) [6-1617052-1](#) [6-1617090-2](#) [6-1617090-5](#) [6-1617347-5](#) [6-1617353-3](#) [6-1617801-8](#) [6-](#)  
[1617802-2](#) [6-1618107-9](#) [6-1618248-4](#) [M83536/1-027M](#) [CX-4014](#) [MAHC-5494](#) [MAVCD-5419-6](#) [703XCX-120A](#) [7-1393100-5](#) [7-1393111-7](#)  
[7-1393144-5](#) [7-1393767-8](#)