

SR Series: Panel Mount Sockets

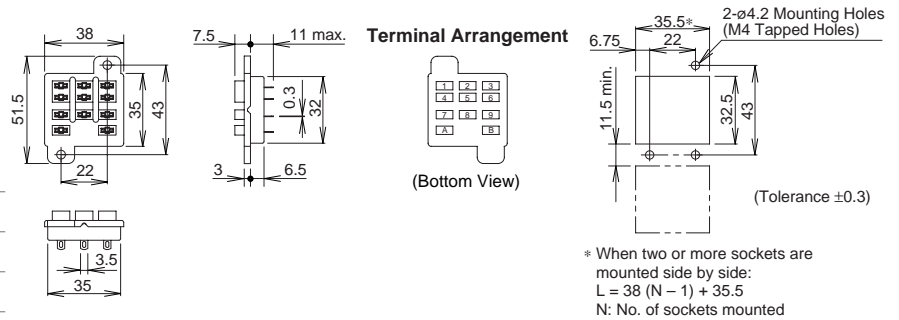

SR3B-51

Style	11-blade, panel mount
Terminal	Solder
Electrical Rating	300V, 10A
Compatible Relay	RR1BA, RR2BA, RR3B
Compatible Timer	RTE-B
Hold-Down Spring	SR3B-02F1 (for relays only)



SR2P-51

Style	8-pin octal, panel mount
Terminal	Solder
Electrical Rating	300V, 10A
Compatible Relay	RR2P
Compatible Timer	RTE-P1, GT3 (8-pin), GT5P
Hold-Down Spring	SR3P-01F1 (for relay only)
Hold-Down Clip	SFA-402 (for GT3 8-pin) SFA-302 (for GT5P)

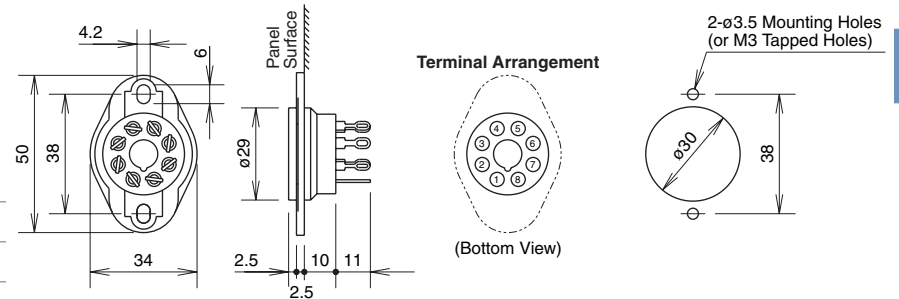

SR3P-51

Style	11-pin octal, panel mount
Terminal	Solder
Electrical Rating	300V, 10A
Compatible Relay	RR3PA, *RR2KP (*latching relay)
Compatible Timer	GT3 (11-pin), RTE-P2
Hold-Down Spring	SR3P-01F1 for RR3PA SR3P-51F3 for RR2KP
Hold-Down Clip	SFA-402 (for GT3 11-pin, RTE-P2)

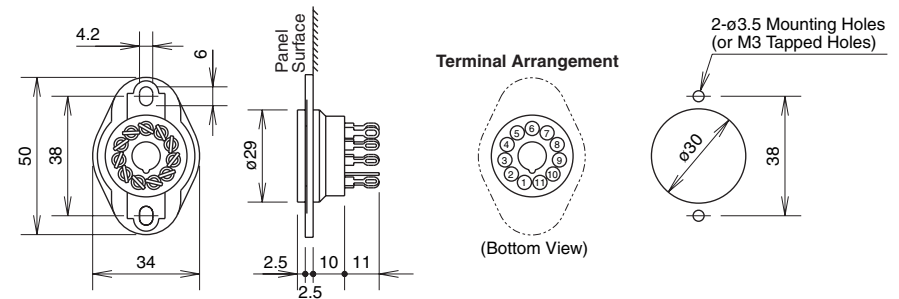

F
Sockets



1. For socket mounting accessories, see page F-29.
2. For hold-down clip/spring selections, see page F-4.

All dimensions are in mm.

SH Series: Panel Mount Sockets

**SH1B-51**

Style	5-blade, panel mount
Terminal	Solder
Electrical Rating	300V, 10A
Compatible Relay	RH1B
Hold-Down Spring	SY4S-51F1
Hold-Down Clip	SFA-301 (top notch), SFA-302 (side notch)

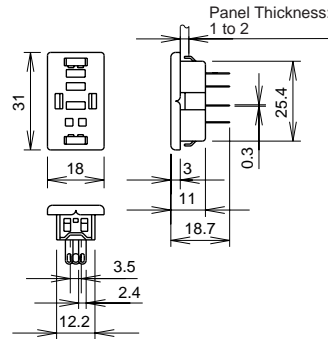
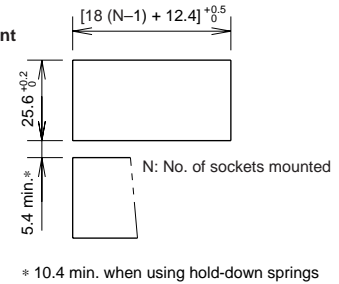
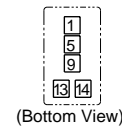
**Terminal Arrangement**

F

Sockets

**SH2B-51**

Style	8-blade, panel mount
Terminal	Solder
Electrical Rating	300V, 10A
Compatible Relay	RH2B
Hold-Down Spring	SY4S-51F1 SY4S-02F1 for RH2B-4C
Hold-Down Clip	SFA-301 (top notch), SFA-302 (side notch)

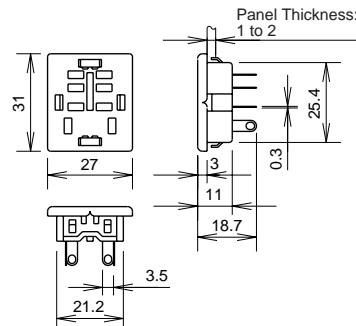
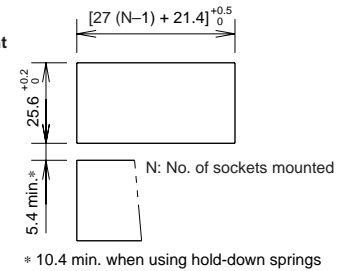
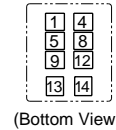
**Terminal Arrangement**

All dimensions are in mm.



1. For socket mounting accessories, see page F-29.
2. For hold-down clip/spring selections, see page F-4.

SH Series: Panel Mount Sockets, continued



SH3B-51

Style	11-blade, panel mount
Terminal	Solder
Electrical Rating	300V, 10A
Compatible Relay	RH3B, *RH2LB (*latching relay)
Hold-Down Spring	SY4S-51F1 SY4S-02F1 for RH3B-4C
Hold-Down Clip	SFA-301 (top notch), SFA-302 (side notch)

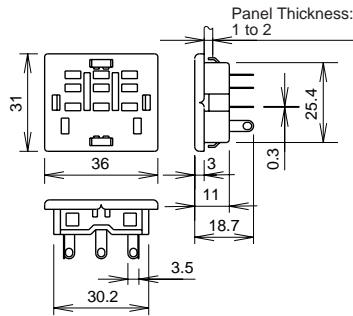

Terminal Arrangement

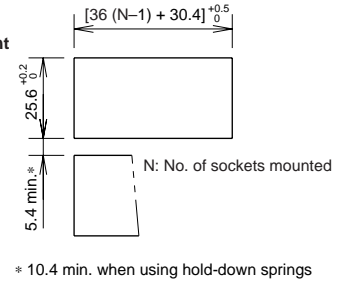
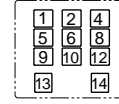

SH4B-51

Style	14-blade, panel mount
Terminal	Solder
Electrical Rating	300V, 10A
Compatible Relay	RH4B
Hold-Down Spring	SY4S-51F1, SY4S-02F1
Hold-Down Clip	SFA-301, SFA-302

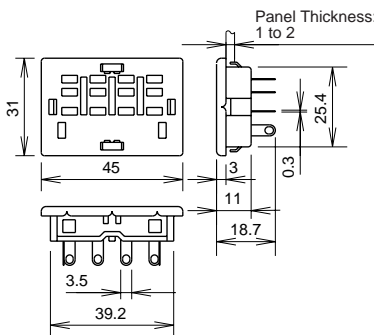

Terminal Arrangement

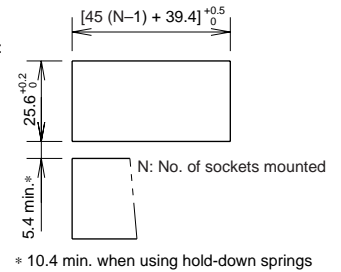
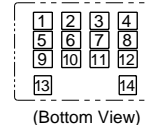

All dimensions are in mm.



1. For socket mounting accessories, see page F-29.
2. For hold-down clip/spring selections, see page F-4.

SY Series: Panel Mount Sockets



SY2S-51

Style	8-blade, panel mount
Terminal	Solder
Electrical Rating	300V, 7A
Compatible Relay	RY2S, RY22S
Hold-Down Spring	SY4S-51F1
Hold-Down Clip	SFA-301 (top notch), SFA-302 (side notch)

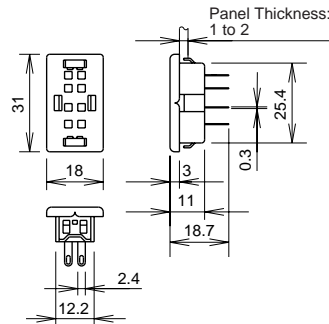

Terminal Arrangement

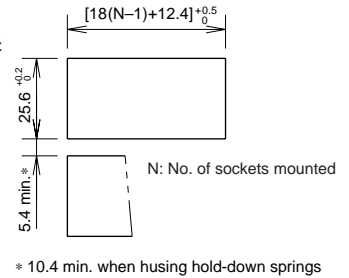
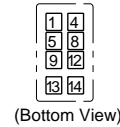

F

Sockets



SY4S-51

Style	14-blade, panel mount
Terminal	Solder
Electrical Rating	300V, 7A
Compatible Relay	RY4S, RY42S, RM2S, RY2KS, RU4S, RU2S, RU42S
Compatible Timer	GT5Y
Hold-Down Spring	SY4S-51F1 for all relays except; SY4S-02F3 for RY2KS relay
Hold-Down Clip	SFA-301 (top notch), SFA-302 (side notch)

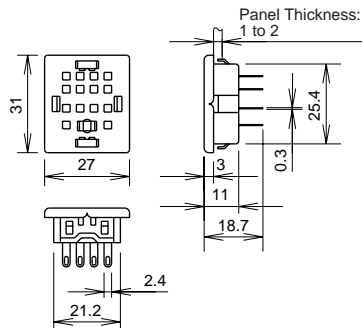

Terminal Arrangement

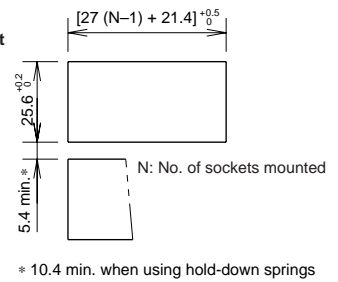
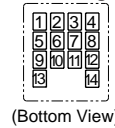

All dimensions are in mm.



1. For socket mounting accessories, see page F-29.
2. For hold-down clip/spring selections, see page F-4.

Accessories

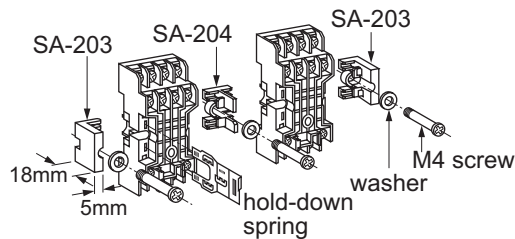

Description	Appearance	Use with	Part No.	Remarks
Aluminum DIN Rail (1 meter length)		All DIN rail sockets	BNDN1000	IDEC offers a low-profile DIN rail (BNDN1000). The BNDN1000 is designed to accommodate snap-mount sockets. Made of durable extruded aluminum, the BNDN-1000 measures 0.413 in height and 1.37 (35mm) in width (DIN standard). Standard length is 39" (1,000mm).
DIN Rail End Stop		DIN rail	BNL5	9.1 mm wide.
Surface Mount End Connector		SY2S, SY4S, SR3B, SH1B, SH2B, SH3B, SH4B	SA-203	For use on ends of socket groupings when surface mounting.
			SA-204	For use between adjoining sockets when surface mounting.
Surface Mount Connector		SY2S, SY4S, SR3B, SH1B, SH2B, SH3B, SH4B	SA-405	For use between adjoining sockets when surface mounting.
DIN Rail Spacer		All DIN rail sockets	SA-406	
Steel Mounting Plates (for panel mount sockets)		SY4S-51, SH2B-51	SA-402	11.42" length with 10 holes.
		SY4S-51, SH2B-51	SA-403	23.33" length with 21 holes.
Relay Holders		RH2B, RM2S, RY4S, RY42S, RU4S, RU42S	RH-01	For diagram, see next page.
		RY2S, RH1B	RH-03	
Replacement Hold-Down Spring Anchor		Horseshoe clip for all DIN rail sockets except SR*P-05(C)	Y778-011	For use with hold-down springs (bale wire types) or DIN rail mount sockets. 2 pieces included with each socket.
Hold-Down Spring for SR*P-05(C)		Chair clip for SR*P-05(C)	Y703-102	For SR2P-05, SR2P-05C, SR3P-05, SR3P-05C

Instructions

Mounting Snap-Mount Sockets

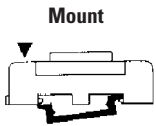

Figure 1

Snap-mount sockets are designed to mount on the BNDN-1000 mounting rail. The built-in mounting clip eliminates mounting hardware and reduces mounting time by 80%.

To mount see Figure 1. Place the end of the socket (end opposite of mounting clip against the outer edge of the rail). Press the socket down firmly until the clip snaps onto the mounting rail. To remove see Figure 2. Pull out the mounting clip with a screwdriver, and lift the socket.

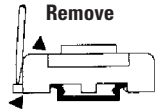
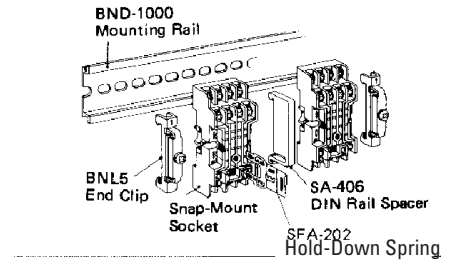

Figure 2

For spacing between adjoining sockets, use the SA-406 DIN rail spacer. Spacers are 0.195" wide. Spacing can be adjusted according to the number of spacers added. Spacers snap on and off easily like snap-mount sockets.

To prevent side-to-side movement, use a BNL-5 end clip at **each** end of every socket row.



Mounting Relay Holders

F
Sockets

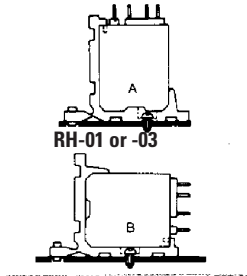

Figure 1

Mount directly onto panel boards in two alternate positions: A and B (see Figure 1).

To mount the relay into the holder, hook the bottom edge of the relay case (coil terminal side) onto the relay holder (see Figure 2).

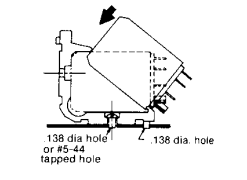

Figure 2

Push down until the relay snaps into place.

Mounting Hold-Down Springs

Take the two anchor clips (horseshoe / U-shaped piece) that come with the socket and insert into the slits on both sides of the socket. Make sure the raised notches on the anchor clip face into the socket.

Plug relay into socket

Insert the open ends of the hold-down spring into either the first or second hole of the anchor clip. The relay-spring combination will determine which hole should be used.

Slide spring over relay.

Dimensions

Surface Mount Sockets (SH2B-02)

IDEC surface mount sockets (SH2B-02) are also designed to mount individually or collectively on a flat surface without the use of a DIN rail. Use the mounting screw between adjoining sockets and at the outer ends of the row of sockets.

Dimension Table

Socket Part No.	Dimension A
SH2B-02	1.14"

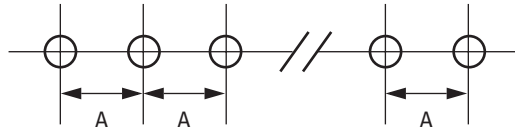

1. Drawing is not to scale.

Snap-Mount Sockets

Snap-mount sockets are designed to mount individually or collectively without using a rail. Use a SA-405 connector or SA-204 connector between adjoining sockets (see Figures 1 and 2). Use the SA-203 end connector at the outer ends of each socket row when using the SA-204 connector (see Figure 2).

Dimension Table

Socket Part No.	Dim. B	Dim. C	Dim. D
SY2S-05, SY2S-05C	0.669"	0.826"	0.866"
SY4S-05, SY4S-05C	1.024"	1.181"	1.220"
SR3B-05	1.496"	1.693"	1.732"
SH1B-05, SH1B-05C	0.630"	0.787"	0.827"
SH2B-05, SH2B-05C	1.024"	1.181"	1.220"
SH3B-05, SH3B-05C	1.417"	1.575"	1.614"
SH4B-05, SH4B-05C	1.811"	1.969"	2.008"

Using an SA-406 Connector

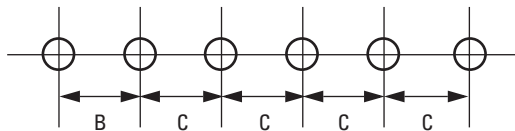

Using SA-203 or SA-204 Connectors

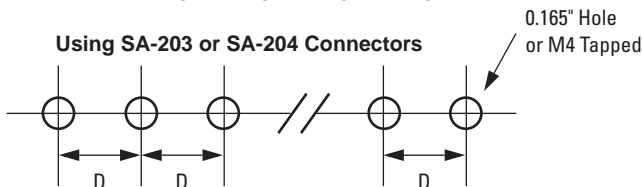

2. Drawings are not to scale.

Dimensions, continued

Collective Panel Mounting

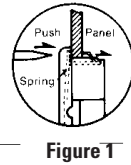
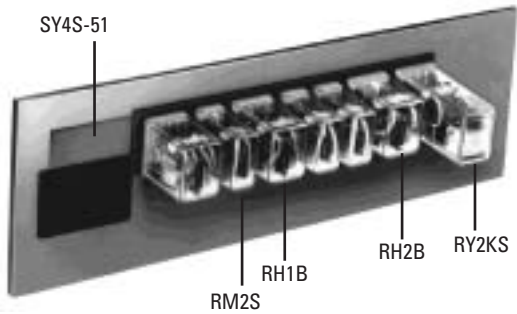

SH and SY series panel mount sockets are designed to mount collectively in panel cut-outs. Insert socket with mounting springs facing the top and bottom edge of the panel cut-out. Push the socket until the mounting spring clips onto the panel. (See Figure 1.)

Dimension Table

Part No.	Width	Relay
SY4S-51	1.063"	RY4S, RY42, RY2KS, RM2S
SH4B-51	1.772"	RH4B
SH3B-51	1.418"	RH3B, RH2LB
SH2B-51	1.063"	RH2B
SH1B-51	0.709"	RH1B
SY2S-51	0.709"	RY2S, RY22S

How to Calculate Cutout Length (L)

Cutout L = A (Total Overall Width of Each Socket) – 0.221" (+ 0", – 0.020")

Example:

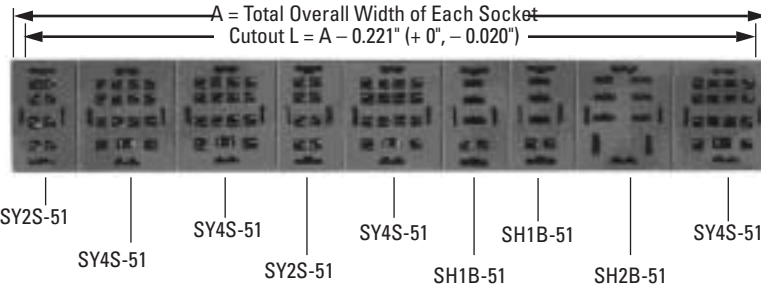

$L = [0.709" + 1.063" + 1.063" + 0.709" + 1.063" + 0.709" + 1.063" + 1.063"] - 0.221" = 7.93"$

$L = 7.93" (+ 0", - 0.020")$

Mounting Plate

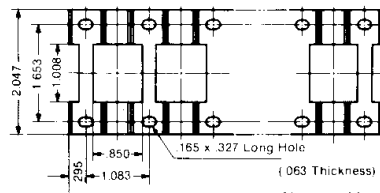

F
Sockets

X-ON Electronics

Largest Supplier of Electrical and Electronic Components

Click to view similar products for [Relay Sockets & Fixings](#) category:

Click to view products by [Idec](#) manufacturer:

Other Similar products are found below :

[0000-825-81-00](#) [60SY4S05](#) [M41G](#) [670-0002](#) [670-0125](#) [670-0127](#) [6700152](#) [670-0153](#) [6700156](#) [D258-2TS00](#) [70-309](#) [7-1393143-3](#) [7-1616360-5](#) [8000-DG2-5](#) [911361](#) [9-1616339-5](#) [PJF11N](#) [GDA12HA](#) [GDA16HD](#) [GDA95A](#) [GDA95D](#) [GUA1](#) [GUA2-20](#) [GUM5R](#) [GUR-120](#) [GUR-24](#) [GUR-240](#) [GUR-277](#) [GURX-277](#) [D52PR2T](#) [RES100K](#) [1310H-HDC](#) [1390H-1ST](#) [1393824-3](#) [1390H-2PC](#) [1410-2SM](#) [1410-3SM](#) [1419106-5](#) [AS-11](#) [1510-1ST](#) [ATC18011](#) [ATC18012](#) [AX-4MS-40](#) [16-1197](#) [16-1278](#) [16-1328](#) [MSL09](#) [MSS09](#) [MT78N60](#) [17540001](#)