

## 22mm XW E-Stops

### Key features:

- The depth behind the panel can be as little as 46.4 mm for 1 to 4 contacts (with terminal cover) for illuminated and non-illuminated units.
- IDEC's original "Safe break action" ensures that the NC contacts open when the contact block is detached from the operator.
- 1 to 4NC main contacts and 1 or 2NO monitor contacts
- Push-to-lock, Pull or Turn-to-reset operator
- Models with mechanical indicator on the operator body show the normal/latched status (green: normal).
- Safety lock mechanism (IEC60947-5-5, 6.2)
- Degree of protection IP65 (IEC60529)
- Fingersafe (IP20) terminals
- Three button sizes: ø38, ø40 and ø60 mm
- Push-ON illumination type available (40mm mushroom head)
- Direct opening action mechanism (IEC60947-5-5, 5.2, IEC60947-5-1, Annex K)
- RoHS compliant (EU directive 2002/95/EC).
- UL c-UL listed. EN compliant
- UL NISD category emergency stop device (File# E305148)



UL File #E68961



CCC No. 2005010305150897





### Specifications



Applicable Standards	IEC60947-5-5, EN60947-5-5, JIS C8201-5-1, UL508, UL991, NFPA79, CSA C22.2 No. 14, GB14048.5
Operating Temperature	Non-illuminated: -25 to +60°C (no freezing), Illuminated: -25 to +55°C (no freezing)
Operating Humidity	45 to 85% RH (no condensation)
Storage Temperature	-45 to +80°C
Operating Force	Push-to-lock: 32N Pull-to-reset: 21N Turn-to-reset: 0.27N·m
Minimum Force Required for Direct Opening Action	80N
Min Operator Stroke Required for Direct Opening Action	4mm
Maximum Operator Stroke	4.5mm
Contact Resistance	50mΩ maximum (initial value)
Contact Material	Gold plated silver
Insulation Resistance	100MΩ minimum (500V DC megger)
Impulse Withstand Voltage	2.5kV
Pollution Degree	3
Operation Frequency	900 operations/hour
Shock Resistance	Operating extremes: 150m/s <sup>2</sup> (15G), Damage limits: 1000m/s <sup>2</sup> (100G)
Vibration Resistance	Operating extremes: 10 to 500Hz, amplitude 0.35mm acceleration 50m/s <sup>2</sup> Damage limits: 10 to 500Hz, amplitude 0.35mm acceleration 50m/s <sup>2</sup>
Mechanical Life	250,000 operations minimum
Electrical Life	100,000 operations minimum, (250,000 operations minimum @ 24V AC/DC, 100mA)
Degree of Protection	Operator: IP65 (IEC60529) Terminal: IP20 (when XW9Z-VL2MF is installed)
Terminal Style	M3.0 screw terminal
Recommended Tightening Torque for Locking Ring	2.0N·m
Wire Size	16 AWG max
Weight	ø40mm: 72g ø60mm: 81g

Part Numbers

Standard Button Without Mechanical Indicator

Style	Operator Type	Monitor Contact	Main Contact	Part Number
 Non-Illuminated 40mm Mushroom		1NO	1NC	XW1E-BV411M-R
		-	2NC	XW1E-BV402M-R
		2NO	2NC	XW1E-BV422M-R
		1NO	3NC	XW1E-BV413M-R
		-	4NC	XW1E-BV404M-R
 60mm Mushroom		1NO	1NC	XW1E-BV511M-R
		-	2NC	XW1E-BV502M-R
		2NO	2NC	XW1E-BV522M-R
		1NO	3NC	XW1E-BV513M-R
		-	4NC	XW1E-BV504M-R
 Illuminated <sup>1</sup> 40mm Mushroom with built-in 24V AC/DC LED		1NO	1NC	XW1E-LV411Q4M-R
		-	2NC	XW1E-LV402Q4M-R
		2NO	2NC	XW1E-LV422Q4M-R
		1NO	3NC	XW1E-LV413Q4M-R
	40mm Mushroom Push-ON LED <sup>2</sup>	-	4NC	XW1E-LV404Q4M-R
		1NO	2NC	XW1E-TV412Q4M-R

Smooth Button With Mechanical Indicator

Style	Operator Type	Monitor Contact	Main Contact	Part Number
 Non-Illuminated 38mm Mushroom		-	1NC	XW1E-BV4TG01MR
		-	2NC	XW1E-BV4TG02MR
		-	3NC	XW1E-BV4TG03MR
		-	4NC	XW1E-BV4TG04MR
		1NO	1NC	XW1E-BV4TG11MR
		1NO	2NC	XW1E-BV4TG12MR
		1NO	3NC	XW1E-BV4TG13MR
 Illuminated 38mm Mushroom with built-in 24V AC/DC LED <sup>1</sup>		2NO	4NC	XW1E-BV4TG22MR
		-	1NC	XW1E-LV4TG01Q4MR
		-	2NC	XW1E-LV4TG02Q4MR
		-	3NC	XW1E-LV4TG03Q4MR
		-	4NC	XW1E-LV4TG04Q4MR
		1NO	1NC	XW1E-LV4TG11Q4MR
		1NO	2NC	XW1E-LV4TG12Q4MR
		1NO	3NC	XW1E-LV4TG13Q4MR
		2NO	2NC	XW1E-LV4TG22Q4MR

- 1. The light is independent of the position of the switch, except for push-on LED type.
- 2. The light only operates when the switch is pressed as it is internally wired.

- Note: Pushlock pull/turn reset switches are locked when pressed, and reset when pulled or turned clockwise.
- 1. LED lamp is not removable.

XW Series EMO Switches

Style	NC Main Contact	NO Monitor Contact	Part Number
 40mm Mushroom	1NC	-	XW1E-BV401M-RH-EMO
	2NC	-	XW1E-BV402M-RH-EMO
	3NC	-	XW1E-BV403M-RH-EMO
	4NC	-	XW1E-BV404M-RH-EMO
	1NC	1NO	XW1E-BV411M-RH-EMO
	2NC	1NO	XW1E-BV412M-RH-EMO
	3NC	1NO	XW1E-BV413M-RH-EMO
	2NC	2NO	XW1E-BV422M-RH-EMO

FB Enclosures with XW E-Stops

 40mm Push-lock Turn/Pull Reset Non-Illuminated	2NC	-	FB1W-XW1E-BV402MR
	1NC	1NO	FB1W-XW1E-BV411MR
	2NC	2NO	FB1W-XW1E-BV422MR
	3NC	1NO	FB1W-XW1E-BV413MR
 40mm Push-lock Turn/Pull Reset Illuminated*	4NC	-	FB1W-XW1E-BV404MR
	2NC	-	FB1W-XW1E-LV402MR
	1NC	1NO	FB1W-XW1E-LV411MR
	2NC	2NO	FB1W-XW1E-LV422MR
 60mm Push-lock Turn/Pull Reset Non-Illuminated	3NC	1NO	FB1W-XW1E-LV413MR
	4NC	-	FB1W-XW1E-LV404MR
	2NC	-	FB1W-XW1E-BV502MR
	1NC	1NO	FB1W-XW1E-BV511MR
	2NC	2NO	FB1W-XW1E-BV522MR
	3NC	1NO	FB1W-XW1E-BV513MR
	4NC	-	FB1W-XW1E-BV504MR



For added safety, Switch Guards and Nameplates can be used with E-Stop Enclosures

- \*LED illumination voltage: 24V AC/DC

Switches & Pilot Devices

Signaling Lights

Relays & Sockets

Timers

Contactors

Terminal Blocks

Circuit Breakers

**Contact Ratings**

Rated Insulation Voltage (Ui)		250V				
Rated Current (Ith)		5A				
Rated Operating Voltage (Ue)		30V	125V	250V		
Rated Operating Current	Main Contacts (NC)	AC 50/60Hz	Resistive Load (AC-12)	–	5A	3A
			Inductive Load (AC-15)	–	3A	1.5A
	DC		Resistive Load (DC-12)	2A	0.4A	0.2A
			Inductive Load (DC-13)	1A	0.22A	0.1A
Rated Operating Current	Monitor Contacts (NO)	AC 50/60Hz	Resistive Load (AC-12)	–	1.2A	0.6A
			Inductive Load (AC-14)	–	0.6A	0.3A
	DC		Resistive Load (DC-12)	2A	0.4A	0.2A
			Inductive Load (DC-13)	1A	0.22A	0.1A

 Minimum applicable load: 5V AC/DC, 1mA (reference value).  
The rated operating currents are measured at resistive/inductive load types specified in IEC 60947-5-1.

**Mounting Hole Layout**

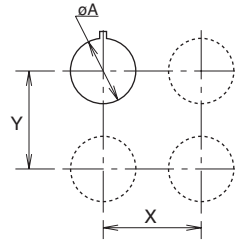

Measurements

Size	øA	X & Y
40mm	22.3 <sup>+0.4</sup>	70mm min

**Panel Cutout**

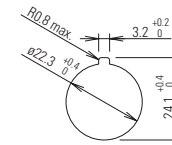

**Depth Behind the Panel**

Depth (mm)	Description
46.4	with indicator, 1 - 4 contacts, both illuminated and non-illuminated
48.7	w/o indicator, 1 - 4 contacts, both illuminated and non-illuminated

**Illuminated Unit LED Ratings**

Operating Voltage	Current
24V AC/DC ±10%	15mA

**Part Number Key**

**XW1E - L V 4 TG 11 Q4MR**

**Illumination**  
 B: Non-Illuminated  
 L: Illuminated LED  
 T: Illuminated Push-ON LED

**Indicator**  
 TG: w/green mechanical indicator  
 blank: w/o indicator

**Contact Configuration**  
 11: 1NO - 1NC  
 02: 2NC  
 13: 1NO - 3NC  
 04: 4NC  
 22: 2NO-2NC  
 12: 1NO-2NC (Push-ON LED only)  
 01: 1NC (EMO switch only)  
 03: 3NC (EMO switch only)

**Color**  
 R: red with indicator  
 -R: red w/o indicator  
 -RH-EMO: red w/o indicator with EMO engraving

**Voltage Code**  
 Blank: Non-illuminated  
 Q4: Illuminated 24V AC/DC

**Mushroom Size**  
 4: ø40mm  
 5: ø60mm (non-illuminated only)

**Terminal Arrangements (Bottom View)**

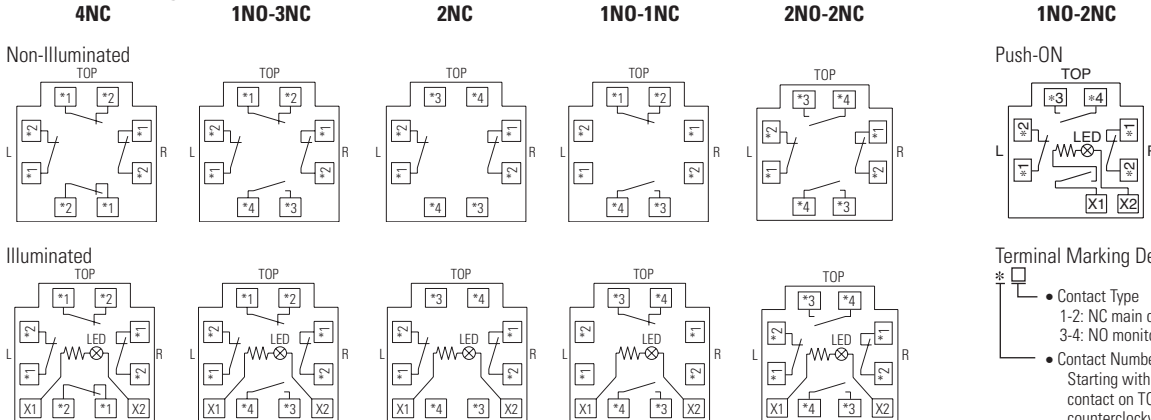

**Terminal Marking Description**

- Contact Type  
 1-2: NC main contact  
 3-4: NO monitor contact
- Contact Number (1-4)  
 Starting with the contact on TOP in a counterclockwise direction.  
 Note:  
 1: contact on the TOP  
 2: contact on the Left  
 3: contact on the Bottom  
 4: contact on the Right

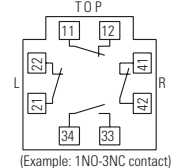

Dimensions (mm)

**XW Standard Button Non-Illuminated Without Indicator (with terminal cover)**

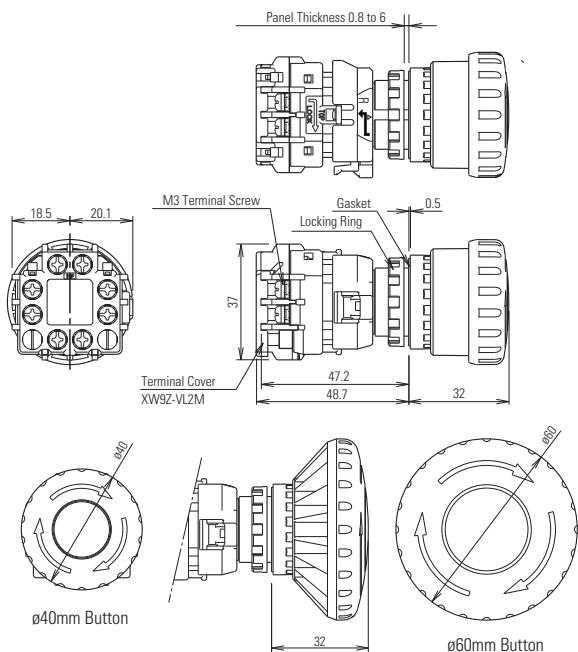

**XW Standard Button LED Illuminated/ Push-ON Without Indicator (with terminal cover)**

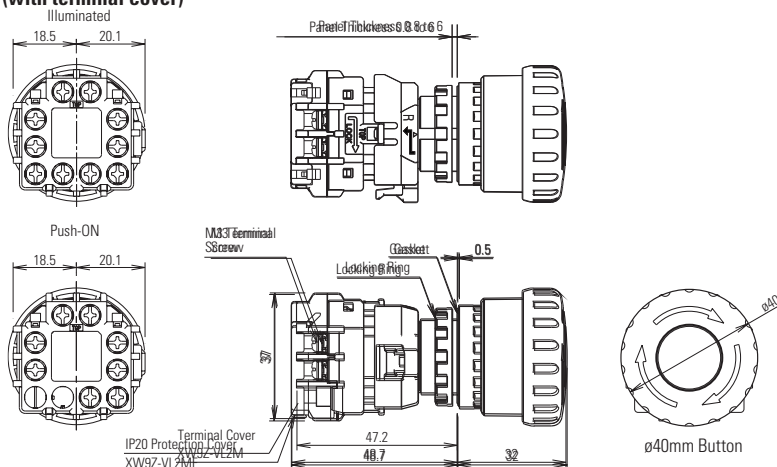

**XW Smooth Button Non-Illuminated With Indicator (with terminal cover)**

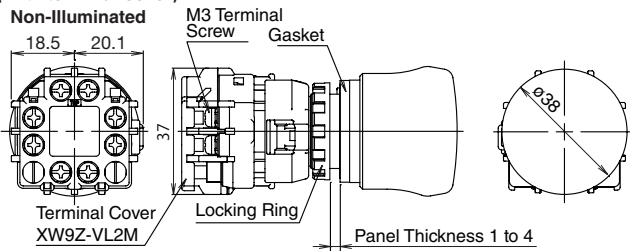

**XW Smooth Button LED Illuminated/ Push-ON With Indicator (with terminal cover)**

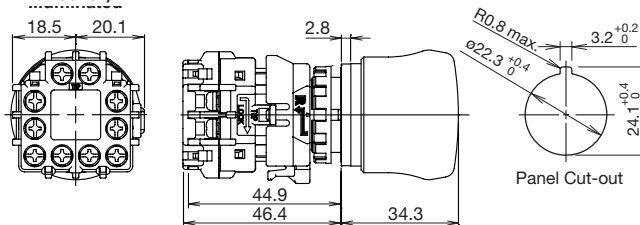

EMO

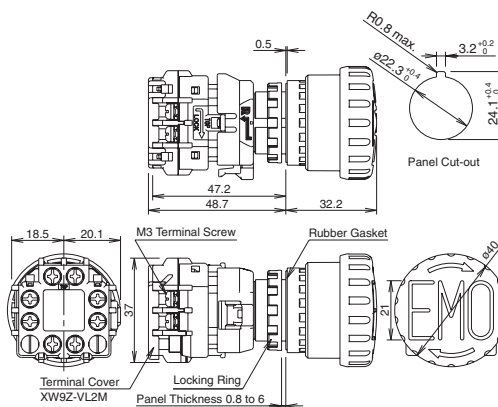
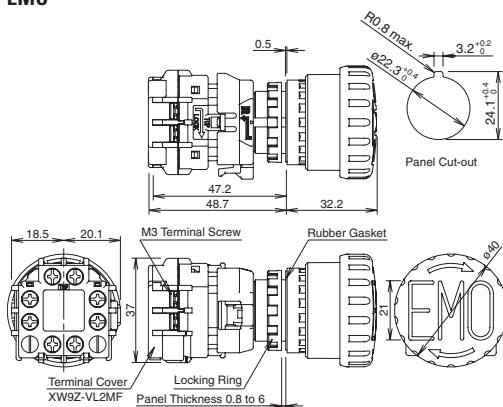

**Accessories: Terminal Covers**





Appearance	Description	Part Numbers
	Terminal Cover for contact block	XW9Z-VL2M
	IP20 Fingersafe Cover	XW9Z-VL2MF

**Accessories: Nameplates**

Appearance	Legend	Part Number	Inner Ø	Outer Ø
	(blank)	HWAV-0	22mm	60mm
	"Emergency Stop"	HWAV-27	22mm	60mm
	(blank)	HWAV5-0	22mm	80mm
	"Emergency Stop"	HWAV5-27	22mm	80mm

 Use 60mm nameplates for 38mm and 40mm mushroom buttons and 80mm nameplates for 60mm mushroom buttons.

**Accessories: Shrouds**

Appearance	Part Numbers	E-Stop Types	Applicable Standards
	HW9Z-KG1	38mm, 40mm Mushroom Head	SEMI S2-0703, 12.5.1 Compliant
	HW9Z-KG2	38mm, 40mm, and 60mm Mushroom Head	SEMI S2-0703, 12.5.1 & SEMATECH Compliant
	HW9Z-KG3	38mm, 40mm Mushroom Head	SEMI S2 Compliant (Approved by TUV)
	HW9Z-KG4	38mm, 40mm Mushroom Head	SEMI S2 Compliant (Approved by TUV) & SEMATECH

**Operating Instructions**

**Removing the Contact Block**

First unlock the operator button. Grab the bayonet ring ① and pull back the bayonet ring until the latch pin clicks ②, then turn the contact block counterclockwise and pull out ③.

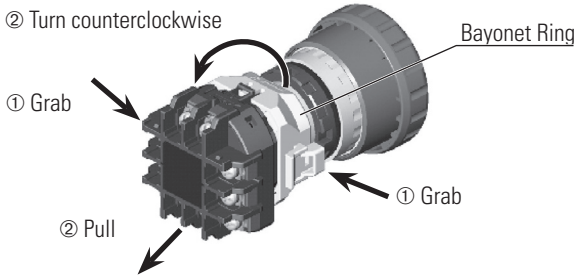

**Notes for removing the contact block**

1. When the contact block is removed, the monitor contact (NO contact) is closed.
2. While removing the contact block, do not exert excessive force, otherwise the switch may be damaged.
3. An LED lamp is built into the contact block for illuminated pushbuttons. When removing the contact block, pull the contact block straight to prevent damage to the LED lamp. If excessive force is exerted, the LED lamp may be damaged and fail to light.

**Panel Mounting**

Remove the locking ring from the operator and check that the rubber gasket is in place. Insert the operator from panel front into the panel hole. Face the side without thread on the operator with TOP marking upward, and tighten the locking ring using ring wrench MW9Z-T1 to a torque of 2.0 N·m maximum.

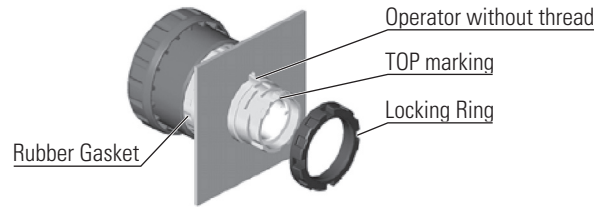

**Notes for Panel Mounting**

To prevent the XW emergency stop switch from rotating when resetting from the latched position, use of an anti-rotation ring (HW9Z-RL) or a nameplate is recommended.

**Installing the Contact Block**

First unlock the operator button. Align the small ▲ marking on the edge of the operator with the small ▼ marking on the yellow bayonet ring. Hold the contact block, not the bayonet ring. Press the contact block onto the operator and turn the contact block clockwise until the bayonet ring clicks.

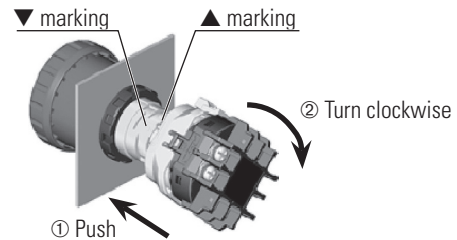

**Notes for installing the contact block**

Make sure that the bayonet ring is in the locked position. Check that the two projections on the bayonet ring are securely in place.

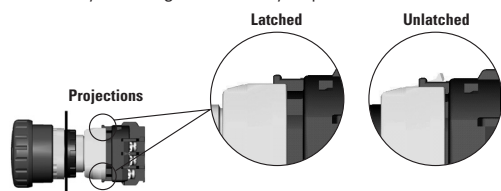

**Wiring**

The applicable wire size is 16 AWG maximum.

**Screw Terminal**

1. Wire thickness: AWG18 to 16
2. Tighten the M3 terminal screw to a tightening torque of 0.6 to 1.0 N·m.

**Installing and Removing Terminal Covers**

**XW9Z-VL2M**

To install the terminal cover, align the TOP marking on the terminal cover with the TOP marking on the contact block. Place the two projections on the bottom side of the contact block into the slots in the terminal cover. Press the terminal cover toward the contact block.

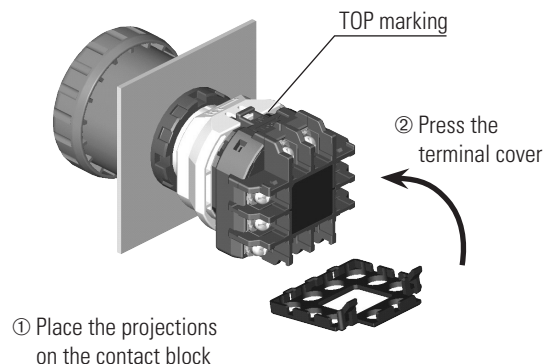

To remove the terminal cover, pull out the two latches on the top side of the terminal cover. Do not exert excessive force to the latches, otherwise the latches may break.

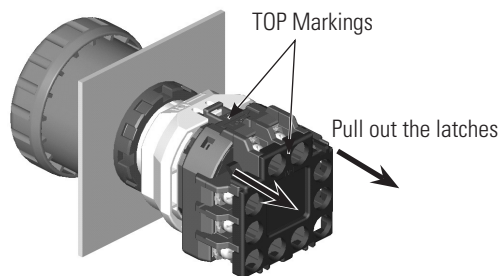

**IP20 Protection Terminal Cover XW9Z-VL2MF**

To install the IP20 protection cover, align the TOP marking on the cover with the TOP marking on the contact block, and press the cover toward the contact block.

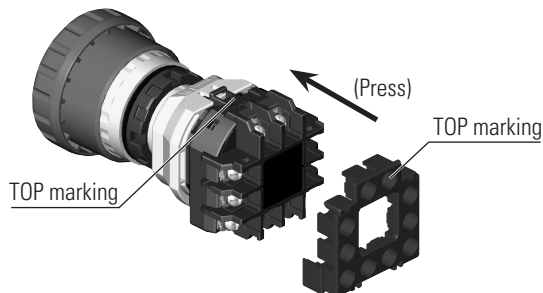

1. Once installed, the XW9Z-VL2MF cannot be removed.
2. The XW9Z-VL2MF cannot be installed after wiring.
3. With the XW9Z-VL2MF installed, crimping terminals cannot be used.
4. Make sure that the XW9Z-VL2MF is securely installed. IP20 protection cannot be achieved when installed loosely, and electric shocks may occur.

**Contact Bounce**

When the button is reset by pulling or turning, the NC main contacts will bounce. When pressing the button, the NO monitor contacts will bounce.

When designing a control circuit, take the contact bounce time into consideration (reference value: 20 ms).

**LED Illuminated Switches**

LED lamp is built into the contact block and cannot be replaced.

**Installing the Anti-rotation Ring HW9Z-RL**

Align the side without thread on the operator with TOP marking, the small s marking on the anti-rotation ring, and the recess on the mounting panel.

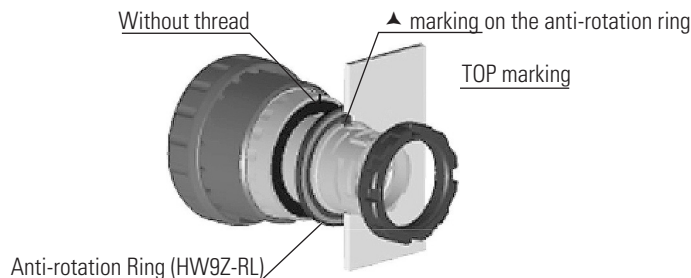

## X-ON Electronics

Largest Supplier of Electrical and Electronic Components

*Click to view similar products for [Pushbutton Switches](#) category:*

*Click to view products by [Idec](#) manufacturer:*

Other Similar products are found below :

[8971K1133](#) [LW2L-M1C20M-A](#) [01-153.025](#) [M22-D-R-GB0/K11](#) [67021K512](#) [701PB580](#) [7199K101](#) [810K12910](#) [810KSV30B](#) [FLT 2U EE](#)  
[01A](#) [MML21EA2ADK](#) [MML21KA3ABK](#) [MML23KW3AA01W](#) [8418K2](#) [8442K3](#) [8450K1](#) [860K11911T01A](#) [861901](#) [861K11911T01A07](#)  
[861K13810T00A14](#) [861K13911](#) [8646AB6X718UL](#) [9533CD4+U574+U4922](#) [99-450.837](#) [99-453.837](#) [A2PMA1X03EC56](#) [A3A-7310](#) [A3A-](#)  
[7340](#) [12037A2ULCSA](#) [1203A2UL](#) [ABGW410-R](#) [1211390004](#) [ABN400-R](#) [121382](#) [1213C3](#) [HE3B-M2](#) [1211500044](#) [121194](#) [1212MRA](#)  
[1232A6NF](#) [121489](#) [1223A2ULCSA](#) [D5P-MT4](#) [13435AG](#) [13445AD29GX768](#) [AG23-L2](#) [AH165-2SGLG1TE3](#) [AH165-TGFY22](#) [AH165-](#)  
[TGL5Y11E3](#) [AH165-TGLR11AA3](#)