

Think Automation and beyond...

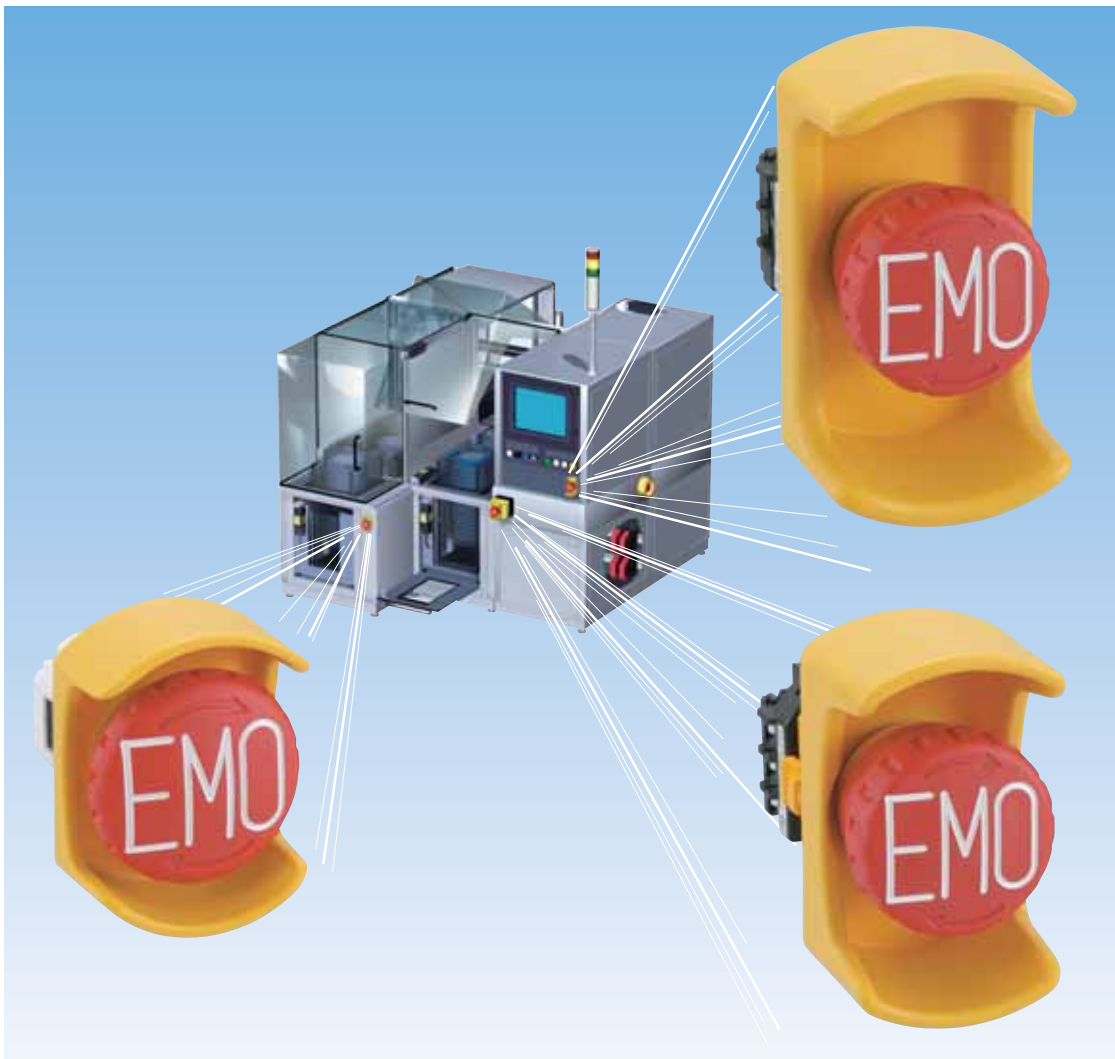

Ø16mm XA Series Ø22mm XW Series

SEMI S2 Compliant EMO Switches and Switch Guards



ø16mm XA Series / ø22mm XW Series SEMI Emergency Off (EMO) Switches

New

XA and XW series emergency stop switches are now available with EMO markings. When used in combination with switch guards ensures compliance to SEMI S2 standards.

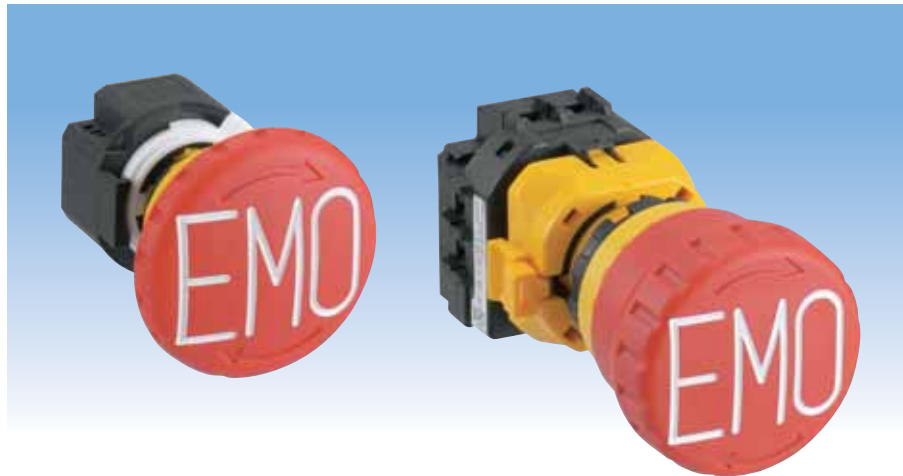

< Structure and Features >

ø16mm XA Series

- World's First** • Up to four contacts
- Only 27.9 mm deep behind the panel for any number of contacts

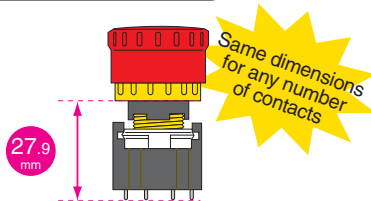

ø22mm XW Series

- World's Shortest** • Shortest for four-contact type
- Only 48.7 mm deep behind the panel for any number of contacts, reducing space.

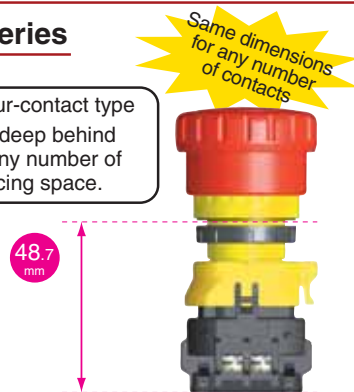

Safe Break Action

- World's First** When the contact block is detached from the operator, the NC contact opens (OFF).

Detaching the Contact Block



When the contact block is detached from the operator, the cam directly opens the NC main contacts (contacts are off).

Direct Opening Action



All normally closed contact elements of an emergency stop devices shall have a direct opening action (positive opening action), according to annex K of IEC 60947-5-1. (IEC 60947-5-5; 5.2)

Achievement of contact separation (of a contact element) of the switch actuator through non-resilient members (for example not dependent upon springs) (IEC 60947-5-1; Annex K)

Safety Lock Mechanism

The emergency stop signal shall be maintained until the emergency stop device is reset (disengaged). (IEC 60947-5-5; 6.2)

Safety Potential Structure

New
3rd-generation
(Safety Potential Structure)

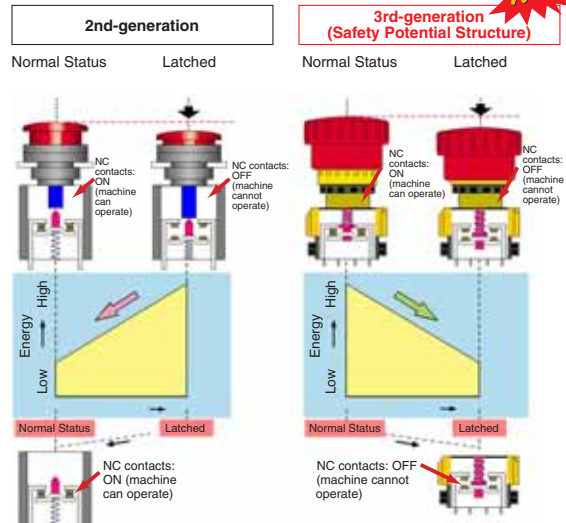

With the XA and XW emergency stop switches, the potential energy level of the latched status is lower than that of the normal status. In the event the contact block is damaged due to excessive shocks, the NC contacts will turn off, thus leading to safety by stopping the machine.

SEMI S2 Compliant Switches / Switch Guards

New



XA Series
+
XA9Z-KG1



XW Series
+
HW9Z-KG3



XW Series
+
HW9Z-KG4



The combination of EMO switch and switch guard can be used with the FB series control boxes. For details, see the FB series control box catalog (EP1132).

The combination of IDEC's EMO switch guards and emergency stop switches are approved by TÜV Rheinland for compliance with SEMI S2 standards.

XA9Z-KG1

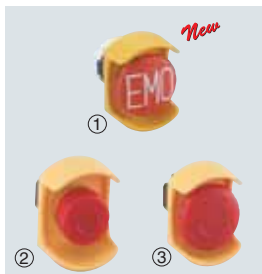

HW9Z-KG3



HW9Z-KG4



SEMI S2-compliant Combinations

EMO Switch Guard	Applicable Emergency Stop Switches
XA9Z-KG1	①: XA1E-BV4****-EMO; ②: XA1E-BV3, XA1E-LV3; ③: XA1E-BV4, XA1E-LV4
HW9Z-KG3	④: XW1E-BV4****-EMO; ⑤: XW1E-BV4, XW1E-LV4, XW1E-TV4; ⑥: HW1B-V3; ⑦: HW1B-V4; ⑧: HW1B-X4; ⑨: HW1B-Y2
HW9Z-KG4	⑩: XW1E-BV4****-EMO; ⑪: XW1E-BV4, XW1E-LV4, XW1E-TV4; ⑫: XW1E-BV5; ⑬: HW1B-V3; ⑭: HW1B-V4; ⑮: HW1E-BV4, HW1B-LV4; ⑯: HW1B-X4; ⑰: HW1B-Y2

Note: Numbers in the circle refer to the pictures of the corresponding control units shown above.

About SEMI

SEMI is an international industry association whose member companies produce materials, equipment, and related technology for manufacturing semiconductor, flat panel display (FPD), and micro-electromechanical systems (MEMS) products. The SEMI safety guideline was published for the semiconductor industry and it is observed with the same importance as standards.

SEMI S2-0706, 12.1 describes as follows; "The equipment should have an 'emergency off' (EMO) circuit. The EMO actuator (e.g., button), when activated, should place the equipment into a safe shutdown condition, without generating any additional hazard to personnel or the facility." Because the semiconductor environment involves solvents and chemicals in many cases, some of which are toxic, interrupting the power source may cause secondary accidents. SEMI safety guideline requires the installation of an emergency off switch which disconnects only the part responsible for the hazardous situation, and maintains the functions of safety-related devices (e.g., smoke detectors, gas/water leak detectors, pressure measurement devices, etc.).

Emergency off buttons should be located or guarded to minimize accidental activation (SEMI S2-0706, 12.5.1). The emergency off button should be red and mushroom shaped. A yellow background for the EMO should be provided (SEMI S2-0706, 12.3).

- Location of EMO switches on semiconductor manufacturing equipment
Acceptance criteria: controls should not be located above 1638 mm (64.5 in.) or below 838 mm (33 in.) (SEMI S8-0705, 9.1.2).
- No operation or regularly scheduled maintenance location should require more than 3 m (10 feet) travel to an EMO button (S2-0706, 12.5.2).

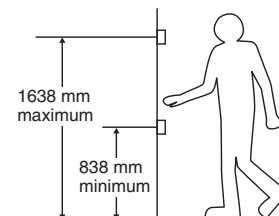

ø16 XA Series SEMI EMO Switches

ø16mm XA Series EMO Switches

**The World's First ø16 mm, 4-contact Emergency Stop Switch.
Compact size—only 27.9 mm deep behind the panel.**

- Lead-free, RoHS compliant.
- The depth behind the panel is only 27.9 mm for 1 to 4 contacts.
- IDEC's original "Safe break action" ensures that the contacts open when the contact block is detached from the operator.
- 1 to 4NC main contacts and 1NO monitor contact
- Push-to-lock, Pull or Turn-to-reset operator
- Direct opening action mechanism (IEC60947-5-5, 5.2, IEC60947-5-1, Annex K)
- Safety lock mechanism (IEC60947-5-5, 6.2)
- Degree of protection IP65 (IEC60529)



Types

Description	NC Main Contact	NO Monitor Contact	Ordering Type No.
ø40mm Mushroom	1NC	–	XA1E-BV401-RH-EMO
	2NC	–	XA1E-BV402-RH-EMO
	3NC	–	XA1E-BV403-RH-EMO
	4NC	–	XA1E-BV404-RH-EMO
	1NC	1NO	XA1E-BV411-RH-EMO
	2NC	1NO	XA1E-BV412-RH-EMO
	3NC	1NO	XA1E-BV413-RH-EMO

- Button color is bright red (RH).
- For detailed specifications and operation of emergency stop switches, see a separate catalog for the XA/XW emergency stop switches (EP1050).

Contact Ratings (NC main contacts/NO monitor contact)

Rated Insulation Voltage (Ui)			300V			
Rated Current (Ith)			5A			
Rated Operating Voltage (Ue)			30V	125V	250V	
Rated Operating Current	Main Contacts	AC 50/60 Hz	Resistive Load (AC-12)	–	3A	3A
			Inductive Load (AC-15)	–	1.5A	1.5A
		DC	Resistive Load (DC-12)	2A	0.4A	0.2A
			Inductive Load (DC-13)	1A	0.22A	0.1A
	Monitor Contacts	AC 50/60 Hz	Resistive Load (AC-12)	–	1.2A	0.6A
			Inductive Load (AC-14)	–	0.6A	0.3A
		DC	Resistive Load (DC-12)	2A	0.4A	0.2A
			Inductive Load (DC-13)	1A	0.22A	0.1A

- Minimum applicable load: 5V AC/DC, 1 mA (reference value) (Operating area may vary according to the operating conditions and load types.)
- The rated operating currents are measured at resistive/inductive load types specified in JIS C8201-5-1.

Dimensions

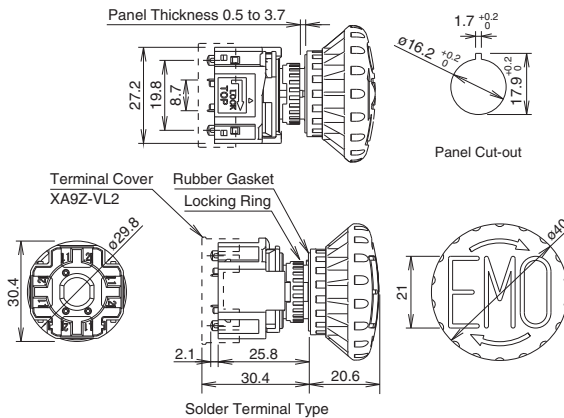

All dimensions in mm.

ø22mm XW Series EMO Switches

ø22 mm, 4-contact Emergency Stop Switch. Compact size—only 48.7 mm deep behind the panel.

- Lead-free, RoHS compliant.
- The depth behind the panel is only 48.7 mm for 1 to 4 contacts
- IDEC's original "Safe break action" ensures that the contacts open when the contact block is detached from the operator.
- 1 to 4NC main contacts and 1 or 2NO monitor contacts
- Push-to-lock, Pull or Turn-to-reset operator
- Direct opening action mechanism (IEC60947-5-5, 5.2, IEC60947-5-1, Annex K)
- Safety lock mechanism (IEC60947-5-5, 6.2)
- Fingersafe screw terminal accessory available (IP20)
- Degree of protection IP65 (IEC60529)
- UL, c-UL approved. EN compliant



Types

Description and Appearance	NC Main Contact	NO Monitor Contact	Ordering Type No.
			w/Terminal Cover
ø40mm Mushroom	1NC	–	XW1E-BV401M-RH-EMO
	2NC	–	XW1E-BV402M-RH-EMO
	3NC	–	XW1E-BV403M-RH-EMO
	4NC	–	XW1E-BV404M-RH-EMO
	1NC	1NO	XW1E-BV411M-RH-EMO
	2NC	1NO	XW1E-BV412M-RH-EMO
	3NC	1NO	XW1E-BV413M-RH-EMO
	2NC	2NO	XW1E-BV422M-RH-EMO

- Button color is bright red (RH).
- For detailed specifications and operation of emergency stop switches, see a separate catalog for the XA/XW emergency stop switches (EP1050).

Contact Ratings (NC main contacts/NO monitor contact)

Rated Insulation Voltage (Ui)		250V				
Rated Current (Ith)		5A				
Rated Operating Voltage (Ue)		30V	125V	250V		
Rated Operating Current	Main Contacts	AC 50/60 Hz	Resistive Load (AC-12)	–	5A	3A
			Inductive Load (AC-15)	–	3A	1.5A
		DC	Resistive Load (DC-12)	2A	0.4A	0.2A
			Inductive Load (DC-13)	1A	0.22A	0.1A
	Monitor Contacts	AC 50/60 Hz	Resistive Load (AC-12)	–	1.2A	0.6A
			Inductive Load (AC-14)	–	0.6A	0.3A
DC		Resistive Load (DC-12)	2A	0.4A	0.2A	
		Inductive Load (DC-13)	1A	0.22A	0.1A	





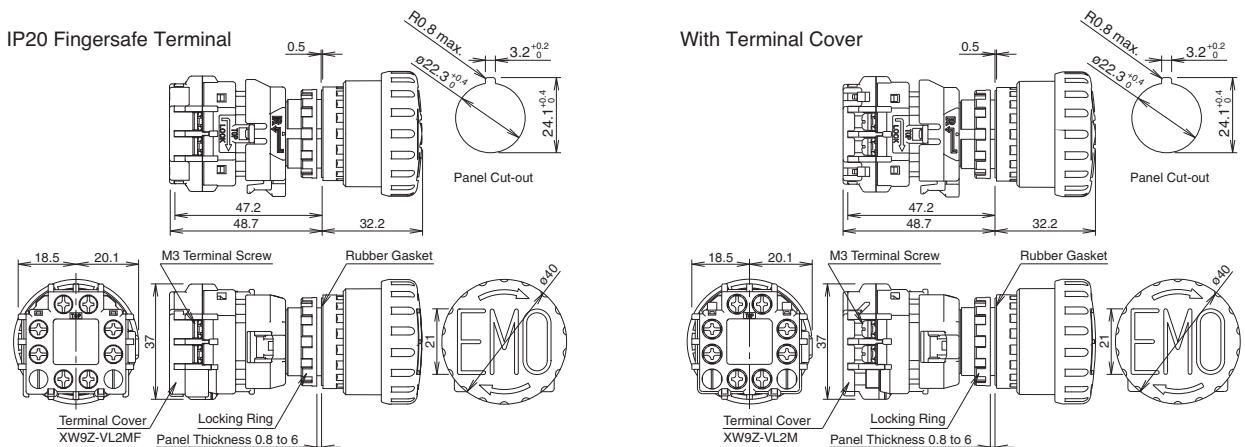

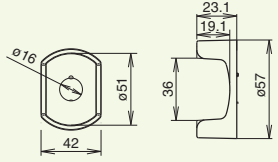

- Minimum applicable load: 5V AC/DC, 1 mA (reference value) (Operating area may vary according to the operating conditions and load types.)
- The rated operating currents are measured at resistive/inductive load types specified in JIS C8201-5-1.

Dimensions

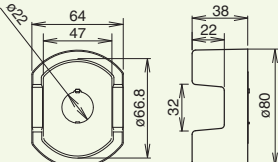

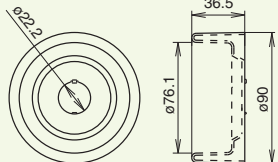
SEMI EMO Switch Guards

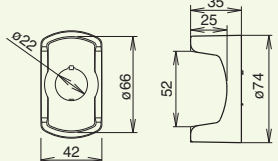
Types

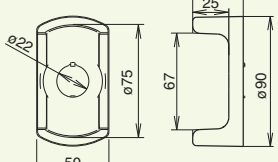
Series	Description & Appearance	Type No.	Specifications	Dimensions (mm)
ø16mm XA	EMO Switch Guard SEMI S2 compliant (Note 1) 	XA9Z-KG1	Polyamide (PA6) Color: Yellow, Munsell 2.5Y8/10 equivalent Degree of protection: IP65 (Note 4)	
ø22mm HW/XW	EMO Switch Guard SEMI S2 compliant (Note 2) 	HW9Z-KG1 (Note 5)		
	EMO Switch Guard SEMI S2 compliant (Note 1) SEMATECH compliant (Note 3) 	HW9Z-KG2 (Note 5)		
	EMO Switch Guard SEMI S2 compliant (Note 1) 	HW9Z-KG3		
	EMO Switch Guard SEMI S2 compliant (Note 1) SEMATECH compliant (Note 3) 	HW9Z-KG4		

Note 1: The combination of IDEC's emergency stop switches and EMO switch guards are approved by TÜV Rheinland for compliance with SEMI S2 standard.

Note 2: SEMI S2-0703, 12.5.1 compliant.

Note 3: SEMATECH Application Guide for SEMI S2-93, 12.4. compliant.

Note 4: Degree of protection IP65 applies to the combination of an emergency stop switch and an EMO switch guard.



Note 5: HW9Z-KG1, HW9Z-KG2, and HW9Z-KG3 can be used with ø29mm or ø40mm mushroom buttons. ø60mm jumbo mushroom buttons cannot be installed.

Note:

EMO switch guards have been designed for applications in semiconductor manufacturing equipment only. Do not use EMO switch guards with emergency stop switches which are installed on machine tools or food processing machines. (Machinery Directive of the European Commission and IEC 60204-1 require that emergency stop switches be installed in a readily accessible area, and the usage of switch guards is not permitted.)

SEMI EMO Switch Guards

Accessories: Terminal Covers

Model	Description	Part Numbers
	Terminal Cover for contact block	XW9Z-VL2M
	IP20 Fingersafe Cover	XW9Z-VL2MF

Panel Cut-out

• $\varnothing 16$ mm

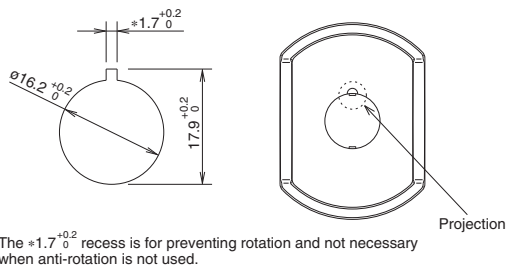

• $\varnothing 22$ mm

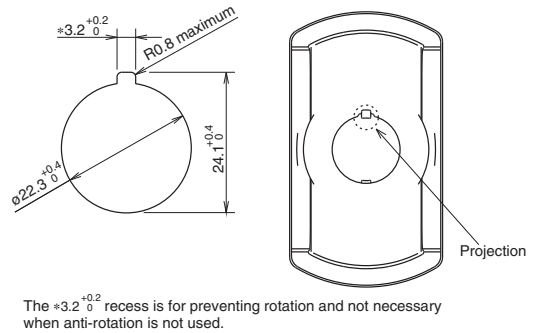

When anti-rotation is not required or when the panel cut-out does not have anti-rotation recess, remove the projection using pliers.

Installation

• $\varnothing 16$ mm

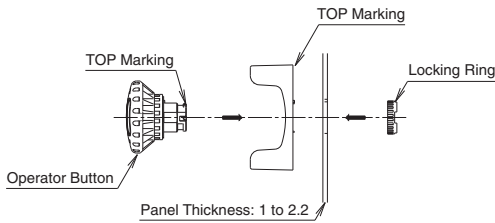

To tighten the locking ring, use locking ring wrench MT-100 and tighten to a torque of 0.88 N-m.

• $\varnothing 22$ mm

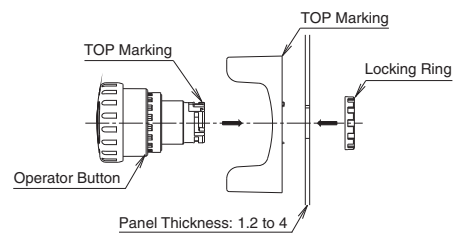

To tighten the locking ring, use locking ring wrench MW9Z-T1 and tighten to a torque of 2.0 N-m.

All dimensions in mm.

EMO Sticker

Type No.: HW9Z-EMO-NPP
Color: Yellow (red legend)
Package Quantity: 10

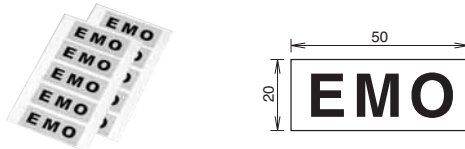

Dimensions

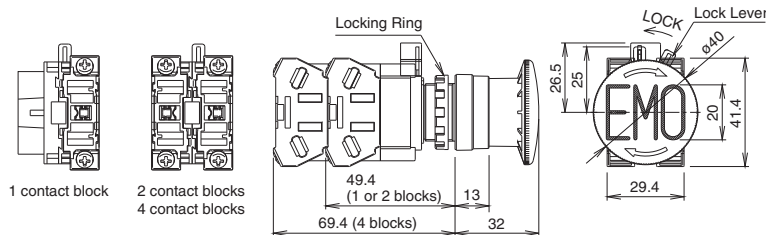

All dimensions in mm.

ø16mm XA Series / ø22mm XW Series Emergency Stop Switches

ø16mm XA Series

The world's first ø16mm, 4-contact emergency stop switch—only 27.9mm deep behind the panel.

- Contact: Main 1NC to 4NC, Monitor 1NO
- Rated Operating Current: Main contacts
AC: 250V, 3A (resistive load)
DC: 250V, 0.2A (resistive load)
Monitor contacts
AC: 250V, 0.6A (resistive load)
DC: 250V, 0.2A (resistive load)
- Illumination Ratings: 24V AC/DC, 11 mA



ø22mm XW Series

The world's first ø22mm, 4-contact emergency stop switch—only 48.7 mm deep behind the panel.

- Contact: Main 1NC to 4NC, Monitor 1NO to 2NO
- Rated Operating Current: Main contacts
AC: 250V, 3A (resistive load)
DC: 250V, 0.2A (resistive load)
Monitor contacts
AC: 250V, 0.6A (resistive load)
DC: 250V, 0.2A (resistive load)
- Illumination Ratings: 24V AC/DC, 15 mA



LW Series Flush Silhouette Switches

Flush bezel projects only 2 mm from front of the panel.

ø28mm round and 28mm square black plastic bezels. Round metal bezels are also available.

- ø25.3mm round panel cut-out, 24.5mm square panel cut-out.
- Collective mounting is possible.
- Separate type control units with a locking lever enable easy installation even when mounted collectively.
- Gold-clad silver or silver contacts.
- IP65 protection (IEC 60529)
- UL recognized and CSA certified. EN compliant.



Specifications and other descriptions in this catalog are subject to change without notice.



IDEC CORPORATION

7-31, Nishi-Miyahara 1-Chome, Yodogawa-ku, Osaka 532-8550, Japan
Tel: +81-6-6398-2571, Fax: +81-6-6392-9731
E-mail: products@idec.co.jp

IDEC CORPORATION (USA)
1175 Elko Drive, Sunnyvale, CA 94089-2209, USA
Tel: +1-408-747-0550 / (800) 262-IDEC (4332)
Fax: +1-408-744-9055 / (800) 635-6246
E-mail: opencontact@idec.com

IDEC CANADA LIMITED
Unit 22-151, Brunel Road, Mississauga, Ontario, L4Z 1X3, Canada
Tel: +1-905-890-8561, Toll Free: (888) 317-4332
Fax: +1-905-890-8562
E-mail: sales@ca.idec.com

IDEC AUSTRALIA PTY. LTD.
2/3 Macro Court, Rowville, Victoria 3178, Australia
Tel: +61-3-9763-3244, Toll Free: 1800-68-4332
Fax: +61-3-9763-3255
E-mail: sales@au.idec.com

IDEC ELECTRONICS LIMITED
Unit 2, Beechwood, Chineham Business Park, Basingstoke, Hampshire RG24 8WA, UK
Tel: +44-1256-321000, Fax: +44-1256-327755
E-mail: sales@uk.idec.com

IDEC ELEKTROTECHNIK GmbH
Wendenstrasse 331, 20537 Hamburg, Germany
Tel: +49-40-25 30 54 - 0, Fax: +49-40-25 30 54 - 24
E-mail: service@idec.de

IDEC (SHANGHAI) CORPORATION
Room 608-609, 6F, Gangtai Plaza, No. 700, Yan'an East Road, Shanghai 200001, PRC
Tel: +86-21-5353-1000, Fax: +86-21-5353-1263
E-mail: idec@cn.idec.com

IDEC (BEIJING) CORPORATION
Room 211B, Tower B, The Grand Pacific Building, 8A Guanghua Road, Chaoyang District, Beijing 100026, PRC
Tel: +86-10-6581-6131, Fax: +86-10-6581-5119

IDEC (SHENZHEN) CORPORATION
Unit AB-3B2, Tian Xiang Building, Tian'an Cyber Park, Fu Tian District, Shenzhen, Guang Dong 518040, PRC
Tel: +86-755-8356-2977, Fax: +86-755-8356-2944

IDEC IZUMI (H.K.) CO., LTD.
Unit 1505-07, DCH Commercial Centre No. 25, Westlands Road, Quarry Bay, Hong Kong
Tel: +852-2803-8989, Fax: +852-2565-0171
E-mail: info@hk.idec.com

IDEC TAIWAN CORPORATION
8F-1, No. 79, Hsin Tai Wu Road, Sec. 1, Hsi-Chih, Taipei County, Taiwan
Tel: +886-2-2698-3929, Fax: +886-2-2698-3931
E-mail: service@tw.idec.com

IDEC IZUMI ASIA PTE. LTD.
No. 31, Tannery Lane #05-01, Dragon Land Building, Singapore 347788
Tel: +65-6746-1155, Fax: +65-6844-5995
E-mail: info@sg.idec.com

X-ON Electronics

Largest Supplier of Electrical and Electronic Components

Click to view similar products for [Switch Fixings](#) category:

Click to view products by [Idec](#) manufacturer:

Other Similar products are found below :

[893102000](#) [00-5150](#) [LZZ1A](#) [0098.9234](#) [61-9451.0](#) [M2PA-5011](#) [630155](#) [635401](#) [6PA113](#) [6PA147-E6](#) [6PA148-E6](#) [6PA32](#) [6PA9](#) [700109](#)
[700303A56](#) [700C1GRY](#) [700C2GRN](#) [704-6001](#) [704.960.4](#) [704.960.9](#) [704.965.2](#) [704.965.6](#) [704.966.0](#) [7089-3](#) [710082-B11](#) [71M1048](#)
[757200264](#) [764300000](#) [MHU35](#) [MHU37](#) [807039-1](#) [825.003.011](#) [825.005.011](#) [825.053.011](#) [825.055.011](#) [826.000.071](#) [827.020.011](#)
[827.400.021](#) [835.900.023](#) [MML52C10C](#) [MML52E10C](#) [MML92HGH](#) [MML93K](#) [84211M02CNNS](#) [84212M02CNNS](#) [84217A8.0LNOS](#)
[842.500.011](#) [843.000.011](#) [843187-000](#) [843487-000](#)