









Cables and Connectors *FDD / HDD cable*

	FDD cable		SATA HDD cable
			
Model Name	32229-000100-100-RS	32200-000058-RS	32801-000703-200-RS
Cable type	FDD flat cable	FDD flat cable	SATA HDD cable
Connector	34p-34p-34p	34p-34p	SATA 7-pin
Connector type	2.54 mm	2.54 mm-2.0 mm	Lockable
Length	37 cm + 15 cm	35 cm	50 cm



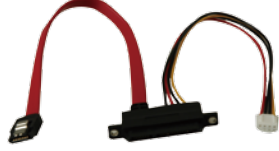
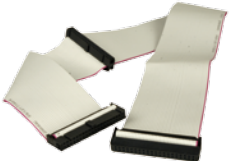

	SATA HDD cable			
				
Model Name	32102-000100-200-RS	32000-080700-RS	32801-000201-100-RS	32801-000100-100-RS
Cable type	SATA power cable	SATA + Power cable	SATA + Power cable	SATA + Power cable
Connector	4-pin model + 2 x SATA 15-pin	SATA 7-pin + 4-pin model	SATA 7-pin + 2-pin wafer 2.0mm	SATA 7-pin + 4-pin wafer 2.54mm
Connector type	SATA power connector		2-pin PH 2.0	4-pin PH 2.54 mm
Length	15 cm	SATA cable 20 cm Power cable 10 cm	SATA cable 15 cm Power cable 15 cm	SATA cable 20 cm Power cable 20 cm





	IDE HDD cable			
				
Model Name	32200-000005-RS	32200-000009-RS	32200-000037-RS	32200-025001-RS
Cable type	IDE HDD flat cable	IDE HDD flat cable	IDE HDD flat cable	IDE HDD flat cable
Connector	40p-40p-40p	44p-44p	44p-44p	44p-40p-40p
Connector type	2.54mm	2.0mm -2.0mm	2.0mm -2.0mm	2.0mm-2.54mm-2.54mm
Length	40 cm + 17 cm	40 cm	25 cm	20 cm + 15 cm





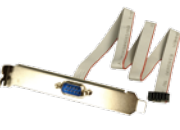
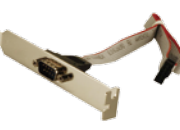

	IDE HDD cable			
				
Model Name	32200-000052-RS	32200-008800-RS	CB-HD32-RS	CVT-4044-RS
Cable type	ATA-66 HDD flat cable	ATA-33 HDD flat cable	IDE HDD flat cable	IDE adapter
Connector	40p-40p-40p	44p-40p-40p	40p-44p	40p-44p
Connector type	2.54mm	2.0mm-2.54mm-2.54mm	2.54mm-2.0mm	2.54mm-2.0mm
Length	30 cm + 15 cm	20 cm + 15 cm	IDE cable: 39 cm Power cable: 20 cm	Power cable: 20 cm





Part numbers listed in the product catalog are for reference purposes. IEI reserves the right to implement substitution parts when the function is not affected.

Cables and Connectors *Paralle / Serial cable*

	Paralle cable				Serial cable
					
Model Name	19800-000400-100-RS	19800-000142-00-RS	19800-000027-RS	32200-015100-RS	19800-000300-100-RS
Cable type	Parallel port cable	Parallel and serial port cable	Parallel and serial port cable	Parallel port cable	Serial port cable
Board side	26-pin (2x13) connector (2.54 mm)	26-pin (2x13) connector (2.54 mm) 10-pin (2x5) connector (2.54 mm)	26-pin (2x13) connector (2.0 mm) 10-pin (2x5) connector (2.0 mm)	26-pin (2x13) connector (2.0 mm)	10-pin (2x5) connector (2.0 mm)
Board side pitch	2.54 mm	2.54 mm	2.0 mm	2.0 mm	2.0 mm
Device side	DB25F	DB25F + DE9M	DB25F + DE9M	DB25F	DE9M
Bracket	Yes	Yes	Yes	No	Yes
Length	24 cm	24 cm	24 cm	28 cm	30 cm





	Serial cable					
						
Model Name	19800-000114-RS	19800-000047-RS	19800-000051-RS	19800-003600-100-RS	19800-000112-RS	32200-000015-RS
Cable type	Serial port cable	Serial port cable	Serial port cable	Serial port cable	Serial port cable	Serial port cable
Board side	10-pin (2x5) connector (2.54 mm)	10-pin (2x5) connector (2.54 mm)	2 x 10-pin (2x5) connector (2.54 mm)	2 x 10-pin (2x5) connector (2.54mm)	2 x 10-pin (2x5) connector (2.0 mm)	10-pin (2x5) connector (2.54 mm)
Board side pitch	2.54 mm	2.54 mm	2.54 mm	2.54 mm	2.0 mm	2.54 mm
Device side	DE9M	DE9M	2 x DE9M	2 x DE9M	2 x DE9M	DE9M
Bracket	Yes	Yes	Yes	Yes	Yes	No
Length	50 cm	30 cm	23 cm	40 cm	30 cm	23 cm





	Serial cable					
						
Model Name	32205-002700-100-RS	32205-001203-100-RS	32100-147900-RS	32200-025401-RS	32200-026800-RS	19800-000058-RS
Cable type	Serial port cable	Serial port cable	Serial port cable	Serial port cable	RS-422/485 cable	RS-232 & RS-422/485 cable
Board side	10-pin (2x5) connector (2.0 mm)	40-pin (2x20) connector (2.54 mm)	40-pin (2x20) connector (2.0 mm)	40-pin (2x20) connector (2.0 mm)	16-pin (2x8) connector (2.54 mm)	14-pin (2x7) connector (2.54 mm)
Board side pitch	2.0 mm	2.54 mm	2.0 mm	2.0 mm	2.54 mm	2.54 mm
Device side	DE9M	4 x DE9M	4 x DE9M	4 x DE9M	4 x DE9M	2 x DE9M
Bracket	No	No	No	No	No	Yes
Length	20 cm	40/40/40/40 cm	30 cm	30 cm	12 cm	25.5 cm

	Serial cable				
					
Model Name	19800-004300-100-RS	32205-000300-100-RS	32205-003700-100-RS	19800-000063-RS	32205-003800-100-RS
Cable type	RS-232 & RS-422/485 cable	RS-232 & RS-422/485 cable	RS-232 & RS-422/485 cable	RS-232 & RS-422/485 cable	RS-422/485 cable
Board side	14-pin (2x7) connector (2.0 mm)	14-pin (2x7) connector (2.0 mm)	14-pin (2x7) connector (2.0 mm)	4-pin (1x4) connector (2.54 mm)	4-pin (1x4) connector (2.0 mm)
Board side pitch	2.0 mm	2.0 mm	2.0 mm	2.54 mm	2.0 mm
Device side	2 x DE9M	2 x DE9M	2 x DE9M	DE9M	DE9M
Bracket	Yes	No	No	No	No
Length	25 cm	29 cm	23 cm	40 cm	20 cm





Part numbers listed in the product catalog are for reference purposes. IEI reserves the right to implement substitution parts when the function is not affected.



Cables and Connectors *USB / 1394 / Y Cable*

USB cable				
				
Model Name	19800-000100-200-RS	19800-003100-200-RS	19800-003000-100-RS	32001-002700-200-RS
Cable type	USB cable	USB cable	USB cable	USB cable
Board side	2 x 4-pin (2x4) connector (2.54mm)	2 x 4-pin (1x4) connector (2.54mm)	1 x 8-pin (2x4) connector (2.0mm)	1 x 8-pin (2x4) connector (2.54mm)
Board side pitch	2.54mm	2.54mm	2.0mm	2.54mm
Device side	4 x USB	2 x USB	2 x USB	2 x USB
Bracket	Yes	Yes	Yes	No
Length	30 cm	30 cm	30 cm	21 cm

USB cable		1394 cable		
				
Model Name	32001-004600-100-RS	32001-008600-100-RS	CB-IEEE1394-RS	19800-000103-RS
Cable type	USB cable	USB cable	1394 cable	1394 cable
Board side	2 x 5-pin connector (2.0mm) for WAFER-8523, WAFER-945GSE3 only	1 x 8-pin (2x4) connector (2.0mm)	2 x 8-pin (1x8) connector (2.0mm)	1 x 8-pin (1x8) connector (2.0mm)
Board side pitch	2.0mm	2.0mm	2.0 mm	2.0 mm
Device side	2 x USB	2 x USB	2 x IEEE1394	1 x IEEE1394
Bracket	No	No	Yes	Yes
Length	40 cm	21 cm	21 cm	25 cm

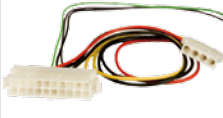
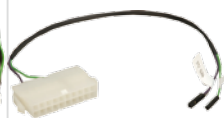

Pin 1	Pin 2	Pin 3	Pin 4
+12V	GND	TPB-	TPB+
Pin 5	Pin 6	Pin 7	Pin 8
TPA-	TPA+	SHIELD	SHIELD





Keyboard / Mouse cable					
					
Model Name	19800-000066-RS	19800-000075-RS	32006-000300-100-RS	32000-043301-RS	32000-023800-RS
Cable type	Keyboard and mouse cable	Y-Cable	Y-Cable	Y-Cable	Y-Cable
Board side	2 x 5-pin (1x5) connector (2.54mm)	1 x 6-pin (1x6) connector (2.0mm)	1 x male PS/2	1 x 6-pin (1x6) connector (2.54mm)	1 x 6-pin (1x6) connector (2.0mm)
Board side pitch	2.54mm	2.0mm		2.54mm	2.0mm
Device side	2 x Female PS/2	2 x Female PS/2	2 x Female PS/2	2 x Female PS/2	2 x Female PS/2
Bracket	Yes	Yes	No	No	No
Length	30 cm	22 cm	12 cm (KB) + 14 (MS)	60 cm	13 cm

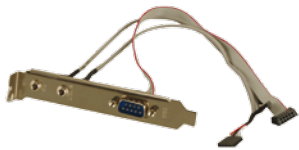
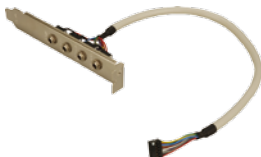

Power cable					
					
Model Name	32100-087100-RS	32100-052100-RS	32100-043403-RS	32100-192900-RS	32100-130300-RS
Cable type	12V power cable	ATX function cable	ATX function cable	12V power cable	Power cable for PC/104 CPU module
Board side	1 x 4-pin (2x2) connector	1 x 20-pin ATX power connector	1 x 20-pin ATX power connector	1 x 4-pin (2x2) connector	1 x 4-pin (1x4) molex
Device side	2 x 4-pin (1x4) molex	1 x 4-pin (1x4) molex 1 x 3-pin PS_ON connector	PS_ON 2.54mm connector	4-pin 3.5 mm terminal block	3-pin 3.5 mm terminal block
Bracket	No	No	No	No	No
Length	13 cm	30 cm	30 cm	25 cm	10 cm

Part numbers listed in the product catalog are for reference purposes. IEI reserves the right to implement substitution parts when the function is not affected.

Cables and Connectors *Audio / LAN / VGA / Adapter Cable*



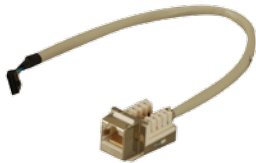

	Audio cable		
			
Model Name	19800-000043-RS	19800-000800-100-RS	19800-000111-RS
Cable type	Audio and Serial cable	Audio cable	Audio cable
Board side	Audio cable: 4-pin (1x4) connector (2.54mm) Serial cable: 10-pin (2x5) connector (2.0mm)	12-pin (2x6) connector (2.0mm)	10-pin (2x5) connector (2.0mm)
Board side pitch	Audio : 2.54mm Serial cable: 2.0mm	2.0mm	2.0mm
Device side	2 x Audio jacks / 1 x DE9M	4 x Audio jacks	3 x Audio jacks
Bracket	Yes	Yes	Yes
Length	30 cm	25 cm	30 cm



	Audio cable			
				
Model Name	32207-000100-100-RS	32007-002700-100-RS	32000-072100-RS	32000-028800-RS
Cable type	Audio cable	Audio cable	Audio cable	Audio cable
Board side	10-pin (2x5) connector (2.54 mm)	16-pin (2x8) connector (2.0mm)	10-pin (2x5) connector (2.0mm)	12-pin (2x6) connector (2.54mm)
Board side pitch	2.54 mm	2.0mm	2.0mm	2.54mm
Device side	10-pin (2x5) dupon	3 x Audio jacks	3 x Audio jacks	4 x Audio jacks
Bracket	No	No	No	No
Length	40 cm	25 cm	30 cm	25 cm

	LAN cable	VGA cable	
			
Model Name	32000-055702-RS	32000-033800-RS	32000-033804-RS
Cable type	LAN cable	VGA cable	VGA cable
Board side	10-pin (2x5) connector (2.0mm)	10-pin (2x5) connector (2.54mm)	10-pin (2x5) connector (2.0mm)
Board side pitch	2.0mm	2.54mm	2.0mm
Device side	1 x RJ-45	1 x DB15F	1 x DB15F
Bracket	No	No	No
Length	31 cm	30 cm	30 cm

Part numbers listed in the product catalog are for reference purposes. IEI reserves the right to implement substitution parts when the function is not affected.

Cables and Connectors *Audio / LAN / VGA / Adapter / TV / Round Cable*

	TV/HDTV-output cable				
					
Model Name	19800-000056-RS	32000-132000-RS	32000-132100-RS	32010-000700-100-RS	32010-000400-100-RS
Cable type	TV-out cable	HDTV cable	HDTV cable	HDTV cable	HDTV cable
Board side	6-pin (2x3) connector (2.54mm)	1 x Mini-DIN 7-pin connector	1 x Mini-DIN 7-pin connector	6-pin (2x3) connector (2.54mm)	6-pin (2x3) connector (2.0mm)
Board side pitch	2.54mm			2.54mm	2.0mm
Device side	1 x RCA jack 1 x S-video jack	3 x RCA jack 1 x S-video jack	3 x RCA jack	3 x RCA jack	3 x RCA jack
Bracket	Yes	No	No	No	No
Length	25 cm	15 cm	15 cm	20 cm	20 cm

	Round cable		
			
Model Name	32000-026800-RS	32000-026900-RS	32100-047401-RS
Cable type	ATA-66 HDD rounded cable	ATA-66 HDD rounded cable	USB cable
Connector	IDE 40p-40p	IDE 40p-40p	1 x 4-pin (1x4) wafer connector (2.0mm)
Board side pitch	2.54mm	2.54mm	2.0mm
Device side	IDE 40-pin	IDE 40-pin	1 x 4-pin (1x4) connector (2.0mm)
Length	75 cm	45 cm	50 cm
Compatible model	RACK-115G, RACK-1151G, RACK-3200G	RACK-115G, RACK-1151G	For front accessible USB port

Part numbers listed in the product catalog are for reference purposes. IEI reserves the right to implement substitution parts when the function is not affected.

Rackmount Slide *Chassis optional Accessories*

	SLIDE		
			
Model Name	SLIDE-18	SLIDE-24	EXTENDER-6
Specification	18" rackmount slide	24" rackmount slide	6" extender
Description	For rackmount chassis w/ depth up to 500	For rackmount chassis w/ depth up to 500	For 18" or 24" slider

X-ON Electronics

Largest Supplier of Electrical and Electronic Components

Click to view similar products for [Specialised Cables category](#):

Click to view products by [IEI manufacturer](#):

Other Similar products are found below :

[603PT6](#) [603SS6L](#) [604PT6](#) [604SS6](#) [706000D02F200](#) [910640](#) [1200740077](#) [1200740114](#) [AC172](#) [ACL-SSI-4](#) [R88ACAKA0015SRE](#)
[R88ACAWL005SDE](#) [R88ACRGD0R3C](#) [1300150047](#) [1300660036](#) [1302262116](#) [1300150149](#) [1300220020](#) [1300220104](#) [1300220119](#)
[1301240492](#) [1301810221](#) [1365323-1](#) [1613055](#) [176P12](#) [1971465-2](#) [20240400003](#) [20240400013](#) [2085828-1](#) [20886510030](#) [2-22733-8](#) [22733-](#)
[8](#) [CB-BATACC-RS](#) [CB-JST3PSW-RS](#) [CB-M12COM-R10](#) [25AC84](#) [25AK84X](#) [25AU25](#) [25FN82](#) [3011-03](#) [AC118](#) [ACL-HHS-1M\(CAT5E\)](#)
[SSL009PC2DC012N](#) [FC2A-KC6C](#) [2085828-2](#) [20886510150](#) [CCSFCBF2](#) [R88A-CRWB020N](#) [416216000-3](#) [426062900-3](#)